

SIEMENS

SIMATIC

S7 S7-1200 Programmable controller



System Manual

| | |
|--|----|
| Preface | |
| Product overview | 1 |
| STEP 7 programming software | 2 |
| Installation | 3 |
| PLC concepts | 4 |
| Device configuration | 5 |
| Programming concepts | 6 |
| Basic instructions | 7 |
| Extended instructions | 8 |
| Technology instructions | 9 |
| Communication | 10 |
| Web server | 11 |
| Communication processor and Modbus TCP | 12 |
| Teleservice communication (SMTP email) | 13 |
| Online and diagnostic tools | 14 |
| SM 1278 4xIO-Link Master | 15 |
| Technical specifications | A |
| Calculating a power budget | B |
| Order numbers | C |
| Exchanging a V3.0 CPU for a V4.0 CPU | D |

Legal information

Warning notice system

This manual contains notices you have to observe in order to ensure your personal safety, as well as to prevent damage to property. The notices referring to your personal safety are highlighted in the manual by a safety alert symbol, notices referring only to property damage have no safety alert symbol. These notices shown below are graded according to the degree of danger.

| |
|--|
|  DANGER |
| indicates that death or severe personal injury will result if proper precautions are not taken. |
|  WARNING |
| indicates that death or severe personal injury may result if proper precautions are not taken. |
|  CAUTION |
| indicates that minor personal injury can result if proper precautions are not taken. |
| NOTICE |
| indicates that property damage can result if proper precautions are not taken. |

If more than one degree of danger is present, the warning notice representing the highest degree of danger will be used. A notice warning of injury to persons with a safety alert symbol may also include a warning relating to property damage.

Qualified Personnel

The product/system described in this documentation may be operated only by **personnel qualified** for the specific task in accordance with the relevant documentation, in particular its warning notices and safety instructions. Qualified personnel are those who, based on their training and experience, are capable of identifying risks and avoiding potential hazards when working with these products/systems.

Proper use of Siemens products

Note the following:

| |
|--|
|  WARNING |
| Siemens products may only be used for the applications described in the catalog and in the relevant technical documentation. If products and components from other manufacturers are used, these must be recommended or approved by Siemens. Proper transport, storage, installation, assembly, commissioning, operation and maintenance are required to ensure that the products operate safely and without any problems. The permissible ambient conditions must be complied with. The information in the relevant documentation must be observed. |

Trademarks

All names identified by ® are registered trademarks of Siemens AG. The remaining trademarks in this publication may be trademarks whose use by third parties for their own purposes could violate the rights of the owner.

Disclaimer of Liability

We have reviewed the contents of this publication to ensure consistency with the hardware and software described. Since variance cannot be precluded entirely, we cannot guarantee full consistency. However, the information in this publication is reviewed regularly and any necessary corrections are included in subsequent editions.

Preface

Purpose of the manual

The S7-1200 series is a line of programmable logic controllers (PLCs) that can control a variety of automation applications. Compact design, low cost, and a powerful instruction set make the S7-1200 a perfect solution for controlling a wide variety of applications. The S7-1200 models and the Windows-based STEP 7 programming tool (Page 35) give you the flexibility you need to solve your automation problems.

This manual provides information about installing and programming the S7-1200 PLCs and is designed for engineers, programmers, installers, and electricians who have a general knowledge of programmable logic controllers.

Required basic knowledge

To understand this manual, it is necessary to have a general knowledge of automation and programmable logic controllers.

Scope of the manual

This manual describes the following products:

- STEP 7 V13 Basic and Professional (Page 35)
- S7-1200 CPU firmware release V4.0

For a complete list of the S7-1200 products described in this manual, refer to the technical specifications (Page 829).

Certification, CE label, C-Tick, and other standards

Refer to the technical specifications (Page 829) for more information.

Service and support

In addition to our documentation, Siemens offers technical expertise on the Internet and on the customer support web site (<http://www.siemens.com/automation/>).

Contact your Siemens distributor or sales office for assistance in answering any technical questions, for training, or for ordering S7 products. Because your sales representatives are technically trained and have the most specific knowledge about your operations, process and industry, as well as about the individual Siemens products that you are using, they can provide the fastest and most efficient answers to any problems you might encounter.

Documentation and information

S7-1200 and STEP 7 provide a variety of documentation and other resources for finding the technical information that you require.

- The S7-1200 system manual provides specific information about the operation, programming, and the specifications for the complete S7-1200 product family. In addition to the system manual, the S7-1200 Easy Book provides a more general overview to the capabilities of the S7-1200 family.

Both the system manual and the Easy Book are available as electronic (PDF) manuals. The electronic manuals can be downloaded from the customer support web site and can also be found on the documentation disk that ships with every S7-1200 CPU.

- The online STEP 7 information system provides immediate access to the conceptual information and specific instructions that describe the operation and functionality of the programming package and basic operation of SIMATIC CPUs.
- My Documentation Manager accesses the electronic (PDF) versions of the SIMATIC documentation set, including the system manual, the Easy Book, and the STEP 7 information system. With My Documentation Manager, you can drag and drop topics from various documents to create your own custom manual.

The customer support entry portal (<http://support.automation.siemens.com>) provides a link to My Documentation Manager under mySupport.

- The customer support web site also provides podcasts, FAQs, and other helpful documents for S7-1200 and STEP 7. The podcasts utilize short educational video presentations that focus on specific features or scenarios in order to demonstrate the interactions, convenience, and efficiency provided by STEP 7. Visit the following web sites to access the collection of podcasts:
 - STEP 7 Basic web page (<http://www.automation.siemens.com/mcmsg/simatic-controller-software/en/step7/step7-basic/Pages/Default.aspx>)
 - STEP 7 Professional web page (<http://www.automation.siemens.com/mcmsg/simatic-controller-software/en/step7/step7-professional/Pages/Default.aspx>)
- You can also follow or join product discussions on the Service & Support technical forum (<https://www.automation.siemens.com/WW/forum/guests/Conferences.aspx?Language=en&siteid=csius&treeLang=en&groupid=4000002&extranet=standard&viewreg=WW&nodeid0=34612486>). These forums allow you to interact with various product experts.
 - Forum for S7-1200 (<https://www.automation.siemens.com/WW/forum/guests/Conference.aspx?SortField=LastPostDate&SortOrder=Descending&ForumID=258&Language=en&onlyInternet=False>)
 - Forum for STEP 7 Basic (<https://www.automation.siemens.com/WW/forum/guests/Conference.aspx?SortField=LastPostDate&SortOrder=Descending&ForumID=265&Language=en&onlyInternet=False>)

Security information

Siemens provides products and solutions with industrial security functions that support the secure operation of plants, solutions, machines, equipment and/or networks. They are important components in a holistic industrial security concept. With this in mind, Siemens' products and solutions undergo continuous development. Siemens recommends strongly that you regularly check for product updates.

For the secure operation of Siemens products and solutions, it is necessary to take suitable preventive action (e.g. cell protection concept) and integrate each component into a holistic, state-of-the-art industrial security concept. Third-party products that may be in use should also be considered. You can find more information about industrial security on the Internet (<http://www.siemens.com/industrialsecurity>).

To stay informed about product updates as they occur, sign up for a product-specific newsletter. You can find more information on the Internet (<http://support.automation.siemens.com>).

Table of contents

| | | |
|----------|---|-----------|
| | Preface | 3 |
| 1 | Product overview | 23 |
| 1.1 | Introducing the S7-1200 PLC..... | 23 |
| 1.2 | Expansion capability of the CPU..... | 26 |
| 1.3 | S7-1200 modules | 29 |
| 1.4 | New features | 30 |
| 1.5 | Basic HMI panels | 32 |
| 2 | STEP 7 programming software | 35 |
| 2.1 | System requirements | 36 |
| 2.2 | Different views to make the work easier | 37 |
| 2.3 | Easy-to-use tools | 38 |
| 2.3.1 | Inserting instructions into your user program..... | 38 |
| 2.3.2 | Accessing instructions from the "Favorites" toolbar..... | 38 |
| 2.3.3 | Creating a complex equation with a simple instruction..... | 39 |
| 2.3.4 | Adding inputs or outputs to a LAD or FBD instruction | 41 |
| 2.3.5 | Expandable instructions | 42 |
| 2.3.6 | Selecting a version for an instruction..... | 42 |
| 2.3.7 | Modifying the appearance and configuration of STEP 7 | 43 |
| 2.3.8 | Dragging and dropping between editors..... | 43 |
| 2.3.9 | Changing the operating mode of the CPU | 44 |
| 2.3.10 | Changing the call type for a DB | 45 |
| 2.3.11 | Temporarily disconnecting devices from a network..... | 46 |
| 2.3.12 | Virtual unplugging of devices from the configuration | 47 |
| 3 | Installation | 49 |
| 3.1 | Guidelines for installing S7-1200 devices..... | 49 |
| 3.2 | Power budget..... | 51 |
| 3.3 | Installation and removal procedures | 53 |
| 3.3.1 | Mounting dimensions for the S7-1200 devices..... | 53 |
| 3.3.2 | Installing and removing the CPU | 56 |
| 3.3.3 | Installing and removing an SB, CB, or BB | 58 |
| 3.3.4 | Installing and removing an SM..... | 60 |
| 3.3.5 | Installing and removing a CM or CP | 62 |
| 3.3.6 | Removing and reinstalling the S7-1200 terminal block connector..... | 63 |
| 3.3.7 | Installing and removing the expansion cable | 64 |
| 3.3.8 | TS (TeleService) adapter | 66 |
| 3.3.8.1 | Connecting the TeleService adapter..... | 66 |
| 3.3.8.2 | Installing the SIM card | 67 |
| 3.3.8.3 | Installing the TS adapter unit on a DIN rail | 69 |
| 3.3.8.4 | Installing the TS adapter on a panel | 69 |

| | | |
|----------|--|-----------|
| 3.4 | Wiring guidelines | 70 |
| 4 | PLC concepts | 77 |
| 4.1 | Execution of the user program | 77 |
| 4.1.1 | Operating modes of the CPU | 81 |
| 4.1.2 | Processing the scan cycle in RUN mode | 85 |
| 4.1.3 | Organization blocks (OBs) | 85 |
| 4.1.3.1 | Program cycle OB | 86 |
| 4.1.3.2 | Startup OB | 86 |
| 4.1.3.3 | Time delay interrupt OB | 87 |
| 4.1.3.4 | Cyclic interrupt OB | 87 |
| 4.1.3.5 | Hardware interrupt OB | 87 |
| 4.1.3.6 | Time error interrupt OB | 88 |
| 4.1.3.7 | Diagnostic error interrupt OB | 89 |
| 4.1.3.8 | Pull or plug of modules OB | 91 |
| 4.1.3.9 | Rack or station failure OB | 92 |
| 4.1.3.10 | Time of day OB | 92 |
| 4.1.3.11 | Status OB | 93 |
| 4.1.3.12 | Update OB | 93 |
| 4.1.3.13 | Profile OB | 94 |
| 4.1.3.14 | Event execution priorities and queuing | 94 |
| 4.1.4 | Monitoring and configuring the cycle time | 97 |
| 4.1.5 | CPU memory | 99 |
| 4.1.5.1 | System and clock memory | 101 |
| 4.1.6 | Diagnostics buffer | 103 |
| 4.1.7 | Time of day clock | 104 |
| 4.1.8 | Configuring the outputs on a RUN-to-STOP transition | 104 |
| 4.2 | Data storage, memory areas, I/O and addressing | 105 |
| 4.2.1 | Accessing the data of the S7-1200 | 105 |
| 4.3 | Processing of analog values | 110 |
| 4.4 | Data types | 110 |
| 4.4.1 | Bool, Byte, Word, and DWord data types | 111 |
| 4.4.2 | Integer data types | 112 |
| 4.4.3 | Floating-point real data types | 112 |
| 4.4.4 | Time and Date data types | 113 |
| 4.4.5 | Character and String data types | 114 |
| 4.4.6 | Array data type | 116 |
| 4.4.7 | Data structure data type | 117 |
| 4.4.8 | PLC data type | 117 |
| 4.4.9 | Pointer data types | 118 |
| 4.4.9.1 | "Pointer" pointer data type | 118 |
| 4.4.9.2 | "Any" pointer data type | 119 |
| 4.4.9.3 | "Variant" pointer data type | 120 |
| 4.4.10 | Accessing a "slice" of a tagged data type | 121 |
| 4.4.11 | Accessing a tag with an AT overlay | 122 |
| 4.5 | Using a memory card | 124 |
| 4.5.1 | Inserting a memory card in the CPU | 125 |
| 4.5.2 | Configuring the startup parameter of the CPU before copying the project to the memory card | 127 |
| 4.5.3 | Transfer card | 127 |

| | | |
|----------|--|------------|
| 4.5.4 | Program card | 130 |
| 4.5.5 | Firmware update | 133 |
| 4.6 | Recovery from a lost password..... | 136 |
| 5 | Device configuration..... | 137 |
| 5.1 | Inserting a CPU | 138 |
| 5.2 | Detecting the configuration for an unspecified CPU | 140 |
| 5.3 | Adding modules to the configuration | 141 |
| 5.4 | Changing a device | 142 |
| 5.5 | Configuring the operation of the CPU | 142 |
| 5.5.1 | Overview | 142 |
| 5.5.2 | Configuring digital input filter times | 144 |
| 5.5.3 | Pulse catch..... | 146 |
| 5.6 | Configuring the parameters of the modules..... | 147 |
| 5.7 | Configuring the CPU for communication | 149 |
| 5.7.1 | Creating a network connection | 149 |
| 5.7.2 | Configuring the Local/Partner connection path..... | 150 |
| 5.7.3 | Parameters for the PROFINET connection | 153 |
| 5.7.4 | Assigning Internet Protocol (IP) addresses | 155 |
| 5.7.4.1 | Assigning IP addresses to programming and network devices | 155 |
| 5.7.4.2 | Checking the IP address of your programming device..... | 157 |
| 5.7.4.3 | Assigning an IP address to a CPU online..... | 158 |
| 5.7.4.4 | Configuring an IP address for a CPU in your project..... | 159 |
| 5.7.5 | Testing the PROFINET network | 162 |
| 5.7.6 | Locating the Ethernet (MAC) address on the CPU..... | 163 |
| 5.7.7 | Configuring Network Time Protocol synchronization..... | 165 |
| 5.7.8 | PROFINET device start-up time, naming, and address assignment..... | 166 |
| 6 | Programming concepts | 169 |
| 6.1 | Guidelines for designing a PLC system..... | 169 |
| 6.2 | Structuring your user program | 170 |
| 6.3 | Using blocks to structure your program | 172 |
| 6.3.1 | Organization block (OB)..... | 172 |
| 6.3.2 | Function (FC) | 174 |
| 6.3.3 | Function block (FB)..... | 175 |
| 6.3.4 | Data block (DB)..... | 176 |
| 6.3.5 | Creating reusable code blocks..... | 177 |
| 6.4 | Understanding data consistency..... | 178 |
| 6.5 | Programming language..... | 179 |
| 6.5.1 | Ladder logic (LAD) | 180 |
| 6.5.2 | Function Block Diagram (FBD) | 181 |
| 6.5.3 | SCL | 181 |
| 6.5.4 | EN and ENO for LAD, FBD and SCL..... | 188 |
| 6.6 | Protection | 190 |
| 6.6.1 | Access protection for the CPU..... | 190 |
| 6.6.2 | Know-how protection | 193 |

| | | |
|----------|---|------------|
| 6.6.3 | Copy protection | 195 |
| 6.7 | Downloading the elements of your program | 196 |
| 6.8 | Uploading from the CPU | 197 |
| 6.8.1 | Copying elements of the project | 197 |
| 6.8.2 | Using the compare function | 198 |
| 6.9 | Debugging and testing the program..... | 198 |
| 6.9.1 | Monitor and modify data in the CPU | 198 |
| 6.9.2 | Watch tables and force tables..... | 199 |
| 6.9.3 | Cross reference to show usage | 199 |
| 6.9.4 | Call structure to examine the calling hierarchy | 201 |
| 7 | Basic instructions..... | 203 |
| 7.1 | Bit logic operations..... | 203 |
| 7.1.1 | Bit logic instructions | 203 |
| 7.1.2 | Set and reset instructions..... | 206 |
| 7.1.3 | Positive and negative edge instructions..... | 209 |
| 7.2 | Timer operations | 212 |
| 7.3 | Counter operations..... | 220 |
| 7.4 | Comparator operations | 226 |
| 7.4.1 | Compare values instructions..... | 226 |
| 7.4.2 | IN_Range (Value within range) and OUT_Range (Value outside range) instructions | 227 |
| 7.4.3 | OK (Check validity) and NOT_OK (Check invalidity) instructions..... | 228 |
| 7.5 | Math functions..... | 229 |
| 7.5.1 | CALCULATE (Calculate) instruction | 229 |
| 7.5.2 | Add, subtract, multiply and divide instructions | 230 |
| 7.5.3 | MOD (return remainder of division) instruction | 231 |
| 7.5.4 | NEG (Create twos complement) instruction..... | 232 |
| 7.5.5 | INC (Increment) and DEC (Decrement) instructions | 232 |
| 7.5.6 | ABS (Form absolute value) instruction | 233 |
| 7.5.7 | MIN (Get minimum) and MAX (Get maximum) instructions..... | 234 |
| 7.5.8 | LIMIT (Set limit value) instruction..... | 235 |
| 7.5.9 | Exponent, logarithm, and trigonometry instructions..... | 236 |
| 7.6 | Move operations..... | 238 |
| 7.6.1 | MOVE (Move value), MOVE_BLK (Move block), and UMOVE_BLK (Move block uninterruptible) instructions..... | 238 |
| 7.6.2 | FieldRead (Read field) and FieldWrite (Write field) instructions | 240 |
| 7.6.3 | FILL_BLK (Fill block) and UFILL_BLK (Fill block uninterruptible) instructions..... | 242 |
| 7.6.4 | SWAP (Swap bytes) instruction | 243 |
| 7.7 | Conversion operations | 244 |
| 7.7.1 | CONV (Convert value) instruction..... | 244 |
| 7.7.2 | Conversion instructions for SCL | 245 |
| 7.7.3 | ROUND (Round numerical value) and TRUNC (Truncate numerical value) instructions..... | 249 |
| 7.7.4 | CEIL and FLOOR (Generate next higher and lower integer from floating-point number) instructions | 250 |
| 7.7.5 | SCALE_X (Scale) and NORM_X (Normalize) instructions | 251 |
| 7.8 | Program control operations..... | 254 |
| 7.8.1 | JMP (Jump if RLO = 1), JMPN (Jump if RLO = 0), and Label (Jump label) instructions..... | 254 |

| | | |
|----------|---|------------|
| 7.8.2 | JMP_LIST (Define jump list) instruction | 255 |
| 7.8.3 | SWITCH (Jump distributor) instruction | 256 |
| 7.8.4 | RET (Return) instruction | 258 |
| 7.8.5 | ENDIS_PW (Enable/disable CPU passwords) instruction | 259 |
| 7.8.6 | RE_TRIGR (Restart cycle monitoring time) instruction | 262 |
| 7.8.7 | STP (Exit program) instruction | 263 |
| 7.8.8 | GET_ERROR and GET_ERROR_ID (Get error and error ID locally) instructions | 263 |
| 7.8.9 | SCL program control statements | 267 |
| 7.8.9.1 | Overview of SCL program control statements | 267 |
| 7.8.9.2 | IF-THEN statement | 268 |
| 7.8.9.3 | CASE statement | 269 |
| 7.8.9.4 | FOR statement | 270 |
| 7.8.9.5 | WHILE-DO statement | 271 |
| 7.8.9.6 | REPEAT-UNTIL statement | 272 |
| 7.8.9.7 | CONTINUE statement | 273 |
| 7.8.9.8 | EXIT statement | 273 |
| 7.8.9.9 | GOTO statement | 274 |
| 7.8.9.10 | RETURN statement | 274 |
| 7.9 | Word logic operations | 275 |
| 7.9.1 | AND, OR, and XOR logic operation instructions | 275 |
| 7.9.2 | INV (Create ones complement) instruction | 276 |
| 7.9.3 | DECO (Decode) and ENCO (Encode) instructions | 276 |
| 7.9.4 | SEL (Select), MUX (Multiplex), and DEMUX (Demultiplex) instructions | 278 |
| 7.10 | Shift and rotate | 281 |
| 7.10.1 | SHR (Shift right) and SHL (Shift left) instructions | 281 |
| 7.10.2 | ROR (Rotate right) and ROL (Rotate left) instructions | 282 |
| 8 | Extended instructions | 283 |
| 8.1 | Date, time-of-day, and clock functions | 283 |
| 8.1.1 | Date and time-of-day instructions | 283 |
| 8.1.2 | Clock functions | 286 |
| 8.1.3 | TimeTransformationRule data structure | 289 |
| 8.1.4 | SET_TIMEZONE (Set timezone) instruction | 290 |
| 8.1.5 | RTM (Runtime meters) instruction | 291 |
| 8.2 | String and character | 292 |
| 8.2.1 | String data overview | 292 |
| 8.2.2 | S_MOVE (Move character string) instruction | 293 |
| 8.2.3 | String conversion instructions | 293 |
| 8.2.3.1 | S_CONV, STRG_VAL, and VAL_STRG (Convert to/from character string and number) instructions | 293 |
| 8.2.3.2 | Strg_TO_Chars and Chars_TO_Strg (Convert to/from character string and array of CHAR) instructions | 302 |
| 8.2.3.3 | ATH and HTA (Convert to/from ASCII string and hexadecimal number) instructions | 304 |
| 8.2.4 | String operation instructions | 306 |
| 8.2.4.1 | MAX_LEN (Maximum length of a character string) instruction | 306 |
| 8.2.4.2 | LEN (Determine the length of a character string) instruction | 307 |
| 8.2.4.3 | CONCAT (Combine character strings) instruction | 307 |
| 8.2.4.4 | LEFT, RIGHT, and MID (Read substrings in a character string) instructions | 308 |
| 8.2.4.5 | DELETE (Delete characters in a character string) instruction | 310 |
| 8.2.4.6 | INSERT (Insert characters in a character string) instruction | 311 |
| 8.2.4.7 | REPLACE (Replace characters in a character string) instruction | 312 |

| | | |
|---------|--|-----|
| 8.2.4.8 | FIND (Find characters in a character string) instruction | 313 |
| 8.3 | Distributed I/O (PROFINET, PROFIBUS, or AS-i) | 314 |
| 8.3.1 | Distributed I/O Instructions | 314 |
| 8.3.2 | RDREC and WRREC (Read/write data record) instructions | 315 |
| 8.3.3 | RALRM (Receive interrupt) instruction | 318 |
| 8.3.4 | STATUS parameter for RDREC, WRREC, and RALRM | 322 |
| 8.3.5 | DPRD_DAT and DPWR_DAT (Read/write consistent data for DP slaves) instructions | 326 |
| 8.3.6 | DPNRM_DG (Read diagnostic data from a DP slave) instruction | 328 |
| 8.4 | Interrupts | 331 |
| 8.4.1 | ATTACH and DETACH (Attach/detach an OB and an interrupt event) instructions..... | 331 |
| 8.4.2 | Cyclic interrupts..... | 334 |
| 8.4.2.1 | SET_CINT (Set cyclic interrupt parameters) instruction | 334 |
| 8.4.2.2 | QRY_CINT (Query cyclic interrupt parameters) instruction | 336 |
| 8.4.3 | Time of day interrupts | 337 |
| 8.4.3.1 | SET_TINTL (Set time of day interrupt)..... | 337 |
| 8.4.3.2 | CAN_TINT (Cancel time of day interrupt) | 339 |
| 8.4.3.3 | ACT_TINT (Activate time of day interrupt) | 339 |
| 8.4.3.4 | QRY_TINT (Query status of time of day interrupt)..... | 340 |
| 8.4.4 | Time delay interrupts..... | 342 |
| 8.4.5 | DIS_AIRT and EN_AIRT (Delay/enable execution of higher priority interrupts and asynchronous error events) instructions | 344 |
| 8.5 | Diagnostics (PROFINET or PROFIBUS) | 345 |
| 8.5.1 | Diagnostic instructions | 345 |
| 8.5.2 | Diagnostic events for distributed I/O | 345 |
| 8.5.3 | LED (Read LED status) instruction | 346 |
| 8.5.4 | DeviceStates instruction..... | 347 |
| 8.5.4.1 | DeviceStates example configurations | 349 |
| 8.5.5 | ModuleStates instruction..... | 353 |
| 8.5.5.1 | ModuleStates example configurations | 354 |
| 8.5.6 | GET_DIAG (Read diagnostic information) instruction | 358 |
| 8.6 | Pulse | 364 |
| 8.6.1 | CTRL_PWM (Pulse width modulation) instruction | 364 |
| 8.6.2 | Operation of the pulse outputs..... | 365 |
| 8.6.3 | Configuring a pulse channel for PWM | 367 |
| 8.7 | Recipes and Data logs | 369 |
| 8.7.1 | Recipes | 369 |
| 8.7.1.1 | Recipe overview..... | 369 |
| 8.7.1.2 | Recipe DB example | 370 |
| 8.7.1.3 | Program instructions that transfer recipe data | 374 |
| 8.7.1.4 | Recipe example program | 378 |
| 8.7.2 | Data logs | 380 |
| 8.7.2.1 | Data log record structure..... | 381 |
| 8.7.2.2 | Program instructions that control data logs..... | 382 |
| 8.7.2.3 | Working with data logs | 392 |
| 8.7.2.4 | Limit to the size of data log files..... | 393 |
| 8.7.2.5 | Data log example program..... | 396 |
| 8.8 | Data block control | 401 |
| 8.8.1 | READ_DBL and WRIT_DBL (Read/write a data block in load memory) instructions | 401 |
| 8.9 | Address handling | 404 |

| | | |
|-----------|---|------------|
| 8.9.1 | LOG2GEO (Determine the slot from the hardware identifier) instruction | 404 |
| 8.9.2 | RD_ADDR (Determine the IO addresses from the hardware identifier) instruction..... | 406 |
| 8.10 | Common error codes for the "Extended" instructions | 407 |
| 9 | Technology instructions..... | 409 |
| 9.1 | High-speed counter..... | 409 |
| 9.1.1 | Operation of the high-speed counter | 411 |
| 9.1.2 | Configuration of the HSC | 417 |
| 9.2 | PID control | 418 |
| 9.2.1 | Inserting the PID instruction and technology object..... | 420 |
| 9.2.2 | PID_Compact instruction | 422 |
| 9.2.3 | PID_Compact instruction ErrorBit parameters | 426 |
| 9.2.4 | PID_3Step instruction | 428 |
| 9.2.5 | PID_3Step instruction ErrorBit parameters | 435 |
| 9.2.6 | Configuring the PID controller..... | 437 |
| 9.2.7 | Commissioning the PID controller..... | 439 |
| 9.3 | Motion control..... | 441 |
| 9.3.1 | Phasing | 446 |
| 9.3.2 | Configuring a pulse generator..... | 448 |
| 9.3.3 | Configuring the axis | 449 |
| 9.3.4 | Configuring the TO_CommandTable_PTO | 452 |
| 9.3.5 | Motion control instructions | 455 |
| 9.3.5.1 | MC instruction overview..... | 455 |
| 9.3.5.2 | MC_Power (Release/block axis) instruction | 456 |
| 9.3.5.3 | MC_Reset (Confirm error) instruction | 459 |
| 9.3.5.4 | MC_Home (Home axis) instruction | 460 |
| 9.3.5.5 | MC_Halt (Pause axis) instruction..... | 462 |
| 9.3.5.6 | MC_MoveAbsolute (Position axis absolutely) instruction | 464 |
| 9.3.5.7 | MC_MoveRelative (Position axis relatively) instruction | 466 |
| 9.3.5.8 | MC_MoveVelocity (Move axis at predefined velocity) instruction..... | 468 |
| 9.3.5.9 | MC_MoveJog (Move axis in jog mode) instruction | 471 |
| 9.3.5.10 | MC_CommandTable (Run axis commands as movement sequence) instruction | 473 |
| 9.3.5.11 | MC_ChangeDynamic (Change dynamic settings for the axis) instruction..... | 476 |
| 9.3.5.12 | MC_WriteParam (write parameters of a technology object) instruction..... | 478 |
| 9.3.5.13 | MC_ReadParam instruction (read parameters of a technology object) instruction | 480 |
| 9.3.6 | Operation of motion control for S7-1200..... | 481 |
| 9.3.6.1 | CPU outputs used for motion control..... | 481 |
| 9.3.6.2 | Hardware and software limit switches for motion control | 483 |
| 9.3.6.3 | Homing | 486 |
| 9.3.6.4 | Jerk limit | 491 |
| 9.3.7 | Commissioning..... | 492 |
| 9.3.8 | Monitoring active commands | 497 |
| 9.3.8.1 | Monitoring MC instructions with a "Done" output parameter | 497 |
| 9.3.8.2 | Monitoring the MC_Velocity instruction..... | 501 |
| 9.3.8.3 | Monitoring the MC_MoveJog instruction..... | 505 |
| 10 | Communication..... | 509 |
| 10.1 | Number of asynchronous communication connections supported | 511 |
| 10.2 | PROFINET | 512 |
| 10.2.1 | Local/Partner connection | 512 |

| | | |
|-----------|--|-----|
| 10.2.2 | Open user communication | 514 |
| 10.2.2.1 | Connection IDs for the Open user communication instructions | 514 |
| 10.2.2.2 | Protocols | 517 |
| 10.2.2.3 | Ad hoc mode | 518 |
| 10.2.2.4 | TCP and ISO on TCP | 519 |
| 10.2.2.5 | TSEND_C and TRCV_C (Send and receive data via Ethernet) instructions | 520 |
| 10.2.2.6 | TCON, TDISCON, TSEND, and TRCV (TCP communication) instructions | 527 |
| 10.2.2.7 | UDP | 535 |
| 10.2.2.8 | TUSEND and TURCV | 535 |
| 10.2.2.9 | T_CONFIG | 541 |
| 10.2.2.10 | Common parameters for instructions | 548 |
| 10.2.3 | Communication with a programming device | 550 |
| 10.2.3.1 | Establishing the hardware communications connection | 550 |
| 10.2.3.2 | Configuring the devices | 551 |
| 10.2.3.3 | Assigning Internet Protocol (IP) addresses | 551 |
| 10.2.3.4 | Testing your PROFINET network | 551 |
| 10.2.4 | HMI-to-PLC communication | 552 |
| 10.2.4.1 | Configuring logical network connections between two devices | 553 |
| 10.2.5 | PLC-to-PLC communication | 553 |
| 10.2.5.1 | Configuring logical network connections between two devices | 554 |
| 10.2.5.2 | Configuring the Local/Partner connection path between two devices | 555 |
| 10.2.5.3 | Configuring transmit (send) and receive parameters | 555 |
| 10.2.6 | Configuring a CPU and PROFINET IO device | 558 |
| 10.2.6.1 | Adding a PROFINET IO device | 558 |
| 10.2.6.2 | Configuring logical network connections between a CPU and a PROFINET IO device | 558 |
| 10.2.6.3 | Assigning CPUs and device names | 559 |
| 10.2.6.4 | Assigning Internet Protocol (IP) addresses | 559 |
| 10.2.6.5 | Configuring the IO cycle time | 560 |
| 10.2.7 | Configuring a CPU and PROFINET iDevice | 561 |
| 10.2.7.1 | I-device functionality | 561 |
| 10.2.7.2 | Properties and advantages of the I-device | 562 |
| 10.2.7.3 | Characteristics of an I-device | 562 |
| 10.2.7.4 | Data exchange between higher- and lower-level IO system | 565 |
| 10.2.7.5 | Configuring the I-device | 567 |
| 10.2.8 | Diagnostics | 569 |
| 10.2.9 | Distributed I/O instructions | 569 |
| 10.2.10 | Diagnostic instructions | 569 |
| 10.2.11 | Diagnostic events for distributed I/O | 569 |
| 10.3 | PROFIBUS | 569 |
| 10.3.1 | Communications services of the PROFIBUS CMs | 571 |
| 10.3.2 | Reference to the PROFIBUS CM user manuals | 572 |
| 10.3.3 | Configuring a DP master and slave device | 572 |
| 10.3.3.1 | Adding the CM 1243-5 (DP master) module and a DP slave | 572 |
| 10.3.3.2 | Configuring logical network connections between two PROFIBUS devices | 573 |
| 10.3.3.3 | Assigning PROFIBUS addresses to the CM 1243-5 module and DP slave | 574 |
| 10.3.4 | Distributed I/O instructions | 575 |
| 10.3.5 | Diagnostic instructions | 575 |
| 10.3.6 | Diagnostic events for distributed | 576 |
| 10.4 | AS-i | 576 |
| 10.4.1 | Configuring an AS-i master and slave device | 577 |
| 10.4.1.1 | Adding the AS-i master CM 1243-2 and AS-i slave | 577 |

| | | |
|-----------|---|------------|
| 10.4.1.2 | Configuring logical network connections between two AS-i devices | 578 |
| 10.4.1.3 | Configuring the properties of the AS-i master CM1243-2..... | 578 |
| 10.4.1.4 | Assigning an AS-i address to an AS-i slave | 579 |
| 10.4.2 | Exchanging data between the user program and AS-i slaves | 582 |
| 10.4.2.1 | STEP 7 basic configuration..... | 582 |
| 10.4.2.2 | Configuring slaves with STEP 7..... | 583 |
| 10.4.3 | Distributed I/O instructions | 585 |
| 10.4.4 | Working with AS-i online tools | 585 |
| 10.5 | S7 communication | 587 |
| 10.5.1 | GET and PUT (Read and write from a remote CPU) instructions | 587 |
| 10.5.2 | Creating an S7 connection..... | 591 |
| 10.5.3 | Configuring the Local/Partner connection path between two devices | 592 |
| 10.5.4 | GET/PUT connection parameter assignment | 592 |
| 10.5.4.1 | Connection parameters..... | 593 |
| 10.5.4.2 | Configuring a CPU-to-CPU S7 connection | 596 |
| 11 | Web server | 601 |
| 11.1 | Enabling the Web server..... | 603 |
| 11.2 | Configuring Web server users | 604 |
| 11.3 | Accessing the Web pages from a PC | 606 |
| 11.4 | Accessing the Web pages from a mobile device | 607 |
| 11.5 | Standard Web pages | 609 |
| 11.5.1 | Layout of the standard Web pages | 609 |
| 11.5.2 | Logging in and user privileges | 610 |
| 11.5.3 | Introduction | 613 |
| 11.5.4 | Start..... | 614 |
| 11.5.5 | Identification | 615 |
| 11.5.6 | Diagnostic Buffer..... | 616 |
| 11.5.7 | Module Information | 616 |
| 11.5.8 | Communication | 620 |
| 11.5.9 | Variable Status..... | 620 |
| 11.5.10 | File Browser | 622 |
| 11.6 | User-defined Web pages | 625 |
| 11.6.1 | Creating HTML pages..... | 626 |
| 11.6.2 | AWP commands supported by the S7-1200 Web server | 627 |
| 11.6.2.1 | Reading variables | 629 |
| 11.6.2.2 | Writing variables..... | 630 |
| 11.6.2.3 | Reading special variables | 631 |
| 11.6.2.4 | Writing special variables | 633 |
| 11.6.2.5 | Using an alias for a variable reference | 634 |
| 11.6.2.6 | Defining enum types | 635 |
| 11.6.2.7 | Referencing CPU variables with an enum type | 635 |
| 11.6.2.8 | Creating fragments | 637 |
| 11.6.2.9 | Importing fragments | 638 |
| 11.6.2.10 | Combining definitions..... | 638 |
| 11.6.2.11 | Handling tag names that contain special characters | 639 |
| 11.6.3 | Configuring use of user-defined Web pages | 641 |
| 11.6.4 | Programming the WWW instruction for user-defined web pages | 642 |
| 11.6.5 | Downloading the program blocks to the CPU | 643 |

| | | |
|-----------|---|------------|
| 11.6.6 | Accessing the user-defined Web pages | 644 |
| 11.6.7 | Constraints specific to user-defined Web pages..... | 644 |
| 11.6.8 | Example of a user-defined web page | 645 |
| 11.6.8.1 | Web page for monitoring and controlling a wind turbine..... | 645 |
| 11.6.8.2 | Reading and displaying controller data..... | 647 |
| 11.6.8.3 | Using an enum type | 648 |
| 11.6.8.4 | Writing user input to the controller | 649 |
| 11.6.8.5 | Writing a special variable | 650 |
| 11.6.8.6 | Reference: HTML listing of remote wind turbine monitor Web page | 650 |
| 11.6.8.7 | Configuration in STEP 7 of the example Web page | 654 |
| 11.6.9 | Setting up user-defined Web pages in multiple languages..... | 656 |
| 11.6.9.1 | Creating the folder structure..... | 656 |
| 11.6.9.2 | Programming the language switch..... | 657 |
| 11.6.9.3 | Configuring STEP 7 to use a multi-language page structure..... | 659 |
| 11.6.10 | Advanced user-defined Web page control..... | 660 |
| 11.7 | Constraints | 664 |
| 11.7.1 | Feature restrictions when the Internet options disable JavaScript | 665 |
| 11.7.2 | Feature restrictions when the Internet options do not allow cookies | 666 |
| 11.7.3 | Importing the Siemens security certificate | 666 |
| 11.7.4 | Importing CSV format data logs to non-USA/UK versions of Microsoft Excel | 667 |
| 12 | Communication processor and Modbus TCP..... | 669 |
| 12.1 | Using the serial communication interfaces | 669 |
| 12.2 | Biasing and terminating an RS485 network connector | 670 |
| 12.3 | Point-to-point (PtP) communication | 671 |
| 12.3.1 | Configuring the communication ports | 672 |
| 12.3.1.1 | Managing flow control | 674 |
| 12.3.2 | Configuring the transmit (send) and receive parameters..... | 675 |
| 12.3.2.1 | Configuring transmit (send) parameters | 675 |
| 12.3.2.2 | Configuring receive parameters | 676 |
| 12.3.3 | Point-to-point instructions..... | 684 |
| 12.3.3.1 | Common parameters for Point-to-Point instructions..... | 684 |
| 12.3.3.2 | PORT_CFG (Configure communication parameters dynamically) instruction..... | 686 |
| 12.3.3.3 | SEND_CFG (Configure serial transmission parameters dynamically) instruction | 688 |
| 12.3.3.4 | RCV_CFG (Configure serial receive parameters dynamically) instruction | 689 |
| 12.3.3.5 | SEND_PTP (Transmit send buffer data) instruction | 694 |
| 12.3.3.6 | RCV_PTP (Enable receive messages) instruction | 697 |
| 12.3.3.7 | RCV_RST (Delete receive buffer) instruction | 698 |
| 12.3.3.8 | SGN_GET (Query RS-232 signals) instruction | 699 |
| 12.3.3.9 | SGN_SET (Set RS-232 signals) instruction..... | 700 |
| 12.3.4 | Programming the PtP communications..... | 702 |
| 12.3.4.1 | Polling architecture..... | 703 |
| 12.3.5 | Example: Point-to-Point communication | 704 |
| 12.3.5.1 | Configuring the communication module..... | 705 |
| 12.3.5.2 | RS422 and RS485 operating modes | 707 |
| 12.3.5.3 | Programming the STEP 7 program..... | 710 |
| 12.3.5.4 | Configuring the terminal emulator | 711 |
| 12.3.5.5 | Running the example program..... | 712 |
| 12.4 | Universal serial interface (USS) communication..... | 712 |
| 12.4.1 | Requirements for using the USS protocol..... | 713 |

| | | |
|-----------|---|------------|
| 12.4.2 | USS_PORT (Edit communication via USS network) instruction..... | 715 |
| 12.4.3 | USS_DRV (Swap data with drive) instruction..... | 716 |
| 12.4.4 | USS_RPM (Readout parameters from the drive) instruction..... | 719 |
| 12.4.5 | USS_WPM (Change parameters in the drive) instruction..... | 720 |
| 12.4.6 | USS status codes..... | 722 |
| 12.4.7 | General drive setup information..... | 724 |
| 12.5 | Modbus communication..... | 727 |
| 12.5.1 | Overview of Modbus RTU and TCP communication Modbus TCP instructions V13..... | 727 |
| 12.5.2 | Modbus TCP..... | 730 |
| 12.5.2.1 | MB_CLIENT (Communicate via PROFINET as Modbus TCP client) instruction..... | 730 |
| 12.5.2.2 | MB_SERVER (Communicate via PROFINET as Modbus TCP server) instruction..... | 736 |
| 12.5.2.3 | MB_SERVER example: Multiple TCP connections..... | 742 |
| 12.5.2.4 | MB_CLIENT example 1: Multiple requests with common TCP connection..... | 743 |
| 12.5.2.5 | MB_CLIENT example 2: Multiple requests with different TCP connections..... | 744 |
| 12.5.2.6 | MB_CLIENT example 3: Output image write request..... | 745 |
| 12.5.2.7 | MB_CLIENT example 4: Coordinating multiple requests..... | 745 |
| 12.5.3 | Modbus RTU..... | 746 |
| 12.5.3.1 | MB_COMM_LOAD (Configure port on the PtP module for Modbus RTU) instruction..... | 747 |
| 12.5.3.2 | MB_MASTER (Communicate via the PtP port as Modbus master) instruction..... | 749 |
| 12.5.3.3 | MB_SLAVE (Communicate via the PtP port as Modbus slave) instruction..... | 755 |
| 12.5.3.4 | Modbus RTU master example program..... | 762 |
| 12.5.3.5 | Modbus RTU slave example program..... | 764 |
| 12.6 | Telecontrol and TeleService with the CP 1242-7..... | 765 |
| 12.6.1 | Connection to a GSM network..... | 765 |
| 12.6.2 | Applications of the CP 1242-7..... | 767 |
| 12.6.3 | Other properties of the CP..... | 768 |
| 12.6.4 | Accessories..... | 769 |
| 12.6.5 | Configuration examples for telecontrol..... | 770 |
| 13 | Teleservice communication (SMTP email)..... | 775 |
| 13.1 | TM_Mail (Send email) instruction..... | 775 |
| 14 | Online and diagnostic tools..... | 783 |
| 14.1 | Status LEDs..... | 783 |
| 14.2 | Going online and connecting to a CPU..... | 786 |
| 14.3 | Assigning a name to a PROFINET IO device online..... | 787 |
| 14.4 | Setting the IP address and time of day..... | 789 |
| 14.5 | Resetting to factory settings..... | 789 |
| 14.6 | Updating firmware..... | 791 |
| 14.7 | CPU operator panel for the online CPU..... | 792 |
| 14.8 | Monitoring the cycle time and memory usage..... | 792 |
| 14.9 | Displaying diagnostic events in the CPU..... | 793 |
| 14.10 | Comparing offline and online CPUs..... | 794 |
| 14.11 | Monitoring and modifying values in the CPU..... | 795 |
| 14.11.1 | Going online to monitor the values in the CPU..... | 796 |
| 14.11.2 | Displaying status in the program editor..... | 797 |

| | | |
|-----------|--|------------|
| 14.11.3 | Capturing the online values of a DB to reset the start values..... | 797 |
| 14.11.4 | Using a watch table to monitor and modify values in the CPU..... | 798 |
| 14.11.4.1 | Using a trigger when monitoring or modifying PLC tags..... | 799 |
| 14.11.4.2 | Enabling outputs in STOP mode..... | 800 |
| 14.11.5 | Forcing values in the CPU..... | 801 |
| 14.11.5.1 | Using the force table..... | 801 |
| 14.11.5.2 | Operation of the Force function..... | 802 |
| 14.12 | Downloading in RUN mode..... | 803 |
| 14.12.1 | Prerequisites for "Download in RUN mode"..... | 804 |
| 14.12.2 | Changing your program in RUN mode..... | 805 |
| 14.12.3 | Downloading selected blocks..... | 806 |
| 14.12.4 | Downloading a single selected block with a compile error in another block..... | 807 |
| 14.12.5 | Modifying and downloading existing blocks in RUN mode..... | 808 |
| 14.12.6 | System reaction if the download process fails..... | 811 |
| 14.12.7 | Considerations when downloading in RUN mode..... | 811 |
| 14.13 | Tracing and recording CPU data on trigger conditions..... | 813 |
| 15 | SM 1278 4xIO-Link Master..... | 815 |
| 15.1 | SM 1278 4xIO-Link Master overview..... | 815 |
| 15.1.1 | Overview..... | 815 |
| 15.1.2 | IO-Link and your STEP 7 program..... | 815 |
| 15.1.3 | Properties..... | 816 |
| 15.1.4 | Functions..... | 817 |
| 15.1.5 | Replacing the SM 4xIO-Link signal module..... | 817 |
| 15.1.6 | Reset module to factory settings..... | 818 |
| 15.2 | Connecting..... | 819 |
| 15.2.1 | Pin assignment..... | 819 |
| 15.2.2 | Block diagram..... | 820 |
| 15.3 | Parameters/address space..... | 821 |
| 15.3.1 | Configuration..... | 821 |
| 15.3.2 | Parameters..... | 821 |
| 15.3.3 | Address space..... | 822 |
| 15.3.4 | Parameter data record..... | 822 |
| 15.4 | Interrupt, error, and system alarms..... | 824 |
| 15.4.1 | Status and error display..... | 824 |
| 15.4.2 | Diagnostic alarms..... | 826 |
| A | Technical specifications..... | 829 |
| A.1 | General technical specifications..... | 829 |
| A.2 | CPU 1211C..... | 837 |
| A.2.1 | General specifications and features..... | 837 |
| A.2.2 | Timers, counters and code blocks supported by CPU 1211C..... | 838 |
| A.2.3 | Digital inputs and outputs..... | 840 |
| A.2.4 | Analog inputs..... | 842 |
| A.2.4.1 | Step response of the built-in analog inputs of the CPU..... | 842 |
| A.2.4.2 | Sample time for the built-in analog ports of the CPU..... | 843 |
| A.2.4.3 | Measurement ranges of the analog inputs for voltage (CPUs)..... | 843 |
| A.2.5 | CPU 1211 wiring diagrams..... | 844 |
| A.3 | CPU 1212C..... | 847 |

| | | |
|---------|---|-----|
| A.3.1 | General specifications and features..... | 847 |
| A.3.2 | Timers, counters and code blocks supported by CPU 1212C | 848 |
| A.3.3 | Digital inputs and outputs..... | 850 |
| A.3.4 | Analog inputs | 852 |
| A.3.4.1 | Step response of the built-in analog inputs of the CPU | 852 |
| A.3.4.2 | Sample time for the built-in analog ports of the CPU..... | 853 |
| A.3.4.3 | Measurement ranges of the analog inputs for voltage (CPUs)..... | 853 |
| A.3.5 | CPU 1212C wiring diagrams..... | 854 |
| A.4 | CPU 1214C | 857 |
| A.4.1 | General specifications and features..... | 857 |
| A.4.2 | Timers, counters and code blocks supported by CPU 1214C | 858 |
| A.4.3 | Digital inputs and outputs..... | 860 |
| A.4.4 | Analog inputs | 862 |
| A.4.4.1 | Step response of the built-in analog inputs of the CPU | 862 |
| A.4.4.2 | Sample time for the built-in analog ports of the CPU..... | 863 |
| A.4.4.3 | Measurement ranges of the analog inputs for voltage (CPUs)..... | 863 |
| A.4.5 | CPU 1214C wiring diagrams..... | 864 |
| A.5 | CPU 1215C | 867 |
| A.5.1 | General specifications and features..... | 867 |
| A.5.2 | Timers, counters and code blocks supported by CPU 1215C | 869 |
| A.5.3 | Digital inputs and outputs..... | 871 |
| A.5.4 | Analog inputs and outputs | 872 |
| A.5.4.1 | Step response of built-in analog inputs of the CPU | 873 |
| A.5.4.2 | Sample time for the built-in analog ports of the CPU..... | 873 |
| A.5.4.3 | Measurement ranges of the analog inputs for voltage (CPUs)..... | 873 |
| A.5.4.4 | Analog output specifications | 874 |
| A.5.5 | CPU 1215C wiring diagrams..... | 875 |
| A.6 | CPU 1217C | 879 |
| A.6.1 | General specifications and features..... | 879 |
| A.6.2 | Timers, counters and code blocks supported by CPU 1217C | 880 |
| A.6.3 | Digital inputs and outputs..... | 882 |
| A.6.4 | Analog inputs and outputs | 887 |
| A.6.4.1 | Analog input specifications | 887 |
| A.6.4.2 | Step response of built-in analog inputs of the CPU | 888 |
| A.6.4.3 | Sample time for the built-in analog ports of the CPU..... | 888 |
| A.6.4.4 | Measurement ranges of the analog inputs for voltage (CPUs)..... | 889 |
| A.6.4.5 | Analog output specifications | 889 |
| A.6.5 | CPU 1217C wiring diagrams..... | 891 |
| A.7 | Digital signal modules (SMs) | 892 |
| A.7.1 | SM 1221 digital input specifications..... | 892 |
| A.7.2 | SM 1222 8-point digital output specifications | 894 |
| A.7.3 | SM 1222 16-point digital output specifications | 895 |
| A.7.4 | SM 1223 digital input/output VDC specifications | 900 |
| A.7.5 | SM 1223 digital input/output AC specifications..... | 904 |
| A.8 | Analog signal modules (SMs) | 907 |
| A.8.1 | SM 1231 analog input module specifications | 907 |
| A.8.2 | SM 1232 analog output module specifications | 910 |
| A.8.3 | SM 1234 analog input/output module specifications | 913 |
| A.8.4 | Step response of the analog inputs | 916 |
| A.8.5 | Sample time and update times for the analog inputs..... | 916 |

| | | |
|----------|--|-----|
| A.8.6 | Measurement ranges of the analog inputs for voltage and current (SB and SM)..... | 916 |
| A.8.7 | Measurement ranges of the analog outputs for voltage and current (SB and SM) | 917 |
| A.9 | Thermocouple and RTD signal modules (SMs) | 919 |
| A.9.1 | SM 1231 Thermocouple..... | 919 |
| A.9.1.1 | Basic operation for a thermocouple | 922 |
| A.9.1.2 | Selection tables for the SM 1231 thermocouple | 923 |
| A.9.2 | SM 1231 RTD | 925 |
| A.9.2.1 | Selection tables for the SM 1231 RTD..... | 928 |
| A.10 | Technology modules | 931 |
| A.10.1 | SM 1278 4xIO-Link Master SM..... | 931 |
| A.10.1.1 | SM 1278 4xIO-Link Master signal module specifications | 931 |
| A.10.1.2 | SM 1278 4xIO-Link Master SM wiring diagrams..... | 934 |
| A.11 | Digital signal boards (SBs)..... | 935 |
| A.11.1 | SB 1221 200 kHz digital input specifications | 935 |
| A.11.2 | SB 1222 200 kHz digital output specifications | 937 |
| A.11.3 | SB 1223 200 kHz digital input / output specifications | 940 |
| A.11.4 | SB 1223 2 X 24 VDC input / 2 X 24 VDC output specifications..... | 943 |
| A.12 | Analog signal boards (SBs)..... | 946 |
| A.12.1 | SB 1231 1 analog input specifications | 946 |
| A.12.2 | SB 1232 1 analog output specifications..... | 948 |
| A.12.3 | Measurement ranges for analog inputs and outputs | 950 |
| A.12.3.1 | Step response of the analog inputs | 950 |
| A.12.3.2 | Sample time and update times for the analog inputs..... | 950 |
| A.12.3.3 | Measurement ranges of the analog inputs for voltage and current (SB and SM)..... | 950 |
| A.12.3.4 | Measurement ranges of the analog outputs for voltage and current (SB and SM) | 951 |
| A.12.4 | Thermocouple signal boards (SBs)..... | 953 |
| A.12.4.1 | SB 1231 1 analog thermocouple input specifications | 953 |
| A.12.4.2 | Basic operation for a thermocouple | 954 |
| A.12.5 | RTD signal boards (SBs) | 957 |
| A.12.5.1 | SB 1231 1 analog RTD input specifications..... | 957 |
| A.12.5.2 | Selection tables for the SB 1231 RTD | 960 |
| A.13 | BB 1297 Battery board..... | 962 |
| A.14 | Communication interfaces..... | 964 |
| A.14.1 | PROFIBUS | 964 |
| A.14.1.1 | CM 1242-5 PROFIBUS DP Slave..... | 964 |
| A.14.1.2 | CM 1243-5 PROFIBUS DP Master | 965 |
| A.14.2 | GPRS | 967 |
| A.14.2.1 | CP 1242-7 GPRS..... | 967 |
| A.14.3 | CM 1243-2 AS-i master..... | 970 |
| A.14.3.1 | Technical data for the AS-i master CM 1243-2..... | 970 |
| A.14.3.2 | Electrical connections of the AS-i master CM 1243-2 | 971 |
| A.14.4 | RS232, RS422, and RS485 | 973 |
| A.14.4.1 | CB 1241 RS485 specifications..... | 973 |
| A.14.4.2 | CM 1241 RS232 specifications | 975 |
| A.14.4.3 | CM 1241 RS422/485 specifications | 976 |
| A.15 | TeleService (TS Adapter and TS Adapter modular) | 978 |
| A.16 | SIMATIC memory cards..... | 978 |
| A.17 | Input simulators | 978 |

| | | |
|----------|---|------------|
| A.18 | S7-1200 Potentiometer module | 980 |
| A.19 | I/O expansion cable | 981 |
| A.20 | Companion products | 982 |
| A.20.1 | PM 1207 power module | 982 |
| A.20.2 | CSM 1277 compact switch module..... | 982 |
| A.20.3 | CM CANopen module | 983 |
| B | Calculating a power budget..... | 985 |
| C | Order numbers..... | 989 |
| C.1 | CPU modules | 989 |
| C.2 | Signal modules (SMs), signal boards (SBs), and battery boards (BB)..... | 989 |
| C.3 | Communication | 991 |
| C.4 | Other modules..... | 992 |
| C.5 | Memory cards | 992 |
| C.6 | Basic HMI devices..... | 992 |
| C.7 | Spare parts and other hardware | 993 |
| C.8 | Programming software | 994 |
| C.9 | Documentation | 994 |
| D | Exchanging a V3.0 CPU for a V4.0 CPU | 995 |
| | Index..... | 999 |

Product overview

1.1 Introducing the S7-1200 PLC

The S7-1200 controller provides the flexibility and power to control a wide variety of devices in support of your automation needs. The compact design, flexible configuration, and powerful instruction set combine to make the S7-1200 a perfect solution for controlling a wide variety of applications.

The CPU combines a microprocessor, an integrated power supply, input and output circuits, built-in PROFINET, high-speed motion control I/O, and on-board analog inputs in a compact housing to create a powerful controller. After you download your program, the CPU contains the logic required to monitor and control the devices in your application. The CPU monitors the inputs and changes the outputs according to the logic of your user program, which can include Boolean logic, counting, timing, complex math operations, and communications with other intelligent devices.

The CPU provides a PROFINET port for communication over a PROFINET network. Additional modules are available for communicating over PROFIBUS, GPRS, RS485 or RS232 networks.

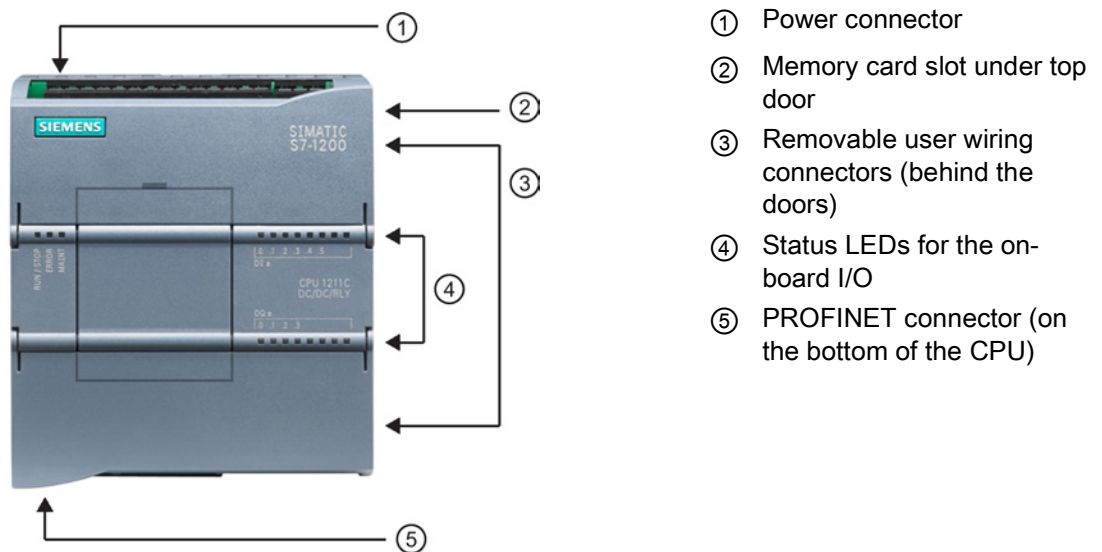

Several security features help protect access to both the CPU and the control program:

- Every CPU provides password protection (Page 190) that allows you to configure access to the CPU functions.
- You can use "know-how protection" (Page 193) to hide the code within a specific block.
- You can use copy protection (Page 195) to bind your program to a specific memory card or CPU.

1.1 Introducing the S7-1200 PLC

Table 1- 1 Comparing the CPU models

| Feature | | CPU 1211C | CPU 1212C | CPU 1214C | CPU 1215C | CPU 1217C |
|--|-------------|--|--------------------|----------------------|----------------------|----------------------|
| Physical size (mm) | | 90 x 100 x 75 | 90 x 100 x 75 | 110 x 100 x 75 | 130 x 100 x 75 | 150 x 100 x 75 |
| User memory | Work | 30 Kbytes | 50 Kbytes | 75 Kbytes | 100 Kbytes | 125 Kbytes |
| | Load | 1 Mbyte | 1 Mbyte | 4 Mbytes | 4 Mbytes | 4 Mbytes |
| | Retentive | 10 Kbytes | 10 Kbytes | 10 Kbytes | 10 Kbytes | 10 Kbytes |
| Local on-board I/O | Digital | 6 inputs/4 outputs | 8 inputs/6 outputs | 14 inputs/10 outputs | 14 inputs/10 outputs | 14 inputs/10 outputs |
| | Analog | 2 inputs | 2 inputs | 2 inputs | 2 inputs/2 outputs | 2 inputs/2 outputs |
| Process image size | Inputs (I) | 1024 bytes | 1024 bytes | 1024 bytes | 1024 bytes | 1024 bytes |
| | Outputs (Q) | 1024 bytes | 1024 bytes | 1024 bytes | 1024 bytes | 1024 bytes |
| Bit memory (M) | | 4096 bytes | 4096 bytes | 8192 bytes | 8192 bytes | 8192 bytes |
| Signal module (SM) expansion | | None | 2 | 8 | 8 | 8 |
| Signal board (SB), Battery board (BB), or communication board (CB) | | 1 | 1 | 1 | 1 | 1 |
| Communication module (CM) (left-side expansion) | | 3 | 3 | 3 | 3 | 3 |
| High-speed counters | Total | Up to 6 configured to use any built-in or SB inputs | | | | |
| | 1 MHz | -- | -- | -- | -- | Ib.2 to Ib.5 |
| | 100/180 kHz | Ia.0 to Ia.5 | Ia.0 to Ia.5 | Ia.0 to Ia.5 | Ia.0 to Ia.5 | Ia.0 to Ia.5 |
| | 30/120 kHz | -- | Ia.6 to Ia.7 | Ia.6 to Ib.5 | Ia.6 to Ib.5 | Ia.6 to Ib.1 |
| Pulse outputs ² | Total | Up to 4 configured to use any built-in or SB outputs | | | | |
| | 1 MHz | -- | -- | -- | -- | Qa.0 to Qa.3 |
| | 100 kHz | Qa.0 to Qa.3 | Qa.0 to Qa.3 | Qa.0 to Qa.3 | Qa.0 to Qa.3 | Qa.4 to Qb.1 |
| | 20 kHz | -- | Qa.4 to Qa.5 | Qa.4 to Qb.1 | Qa.4 to Qb.1 | -- |
| Memory card | | SIMATIC Memory card (optional) | | | | |
| Real time clock retention time | | 20 days, typ./12 day min. at 40 degrees C (maintenance-free Super Capacitor) | | | | |
| PROFINET Ethernet communication port | | 1 | 1 | 1 | 2 | 2 |
| Real math execution speed | | 2.3 µs/instruction | | | | |
| Boolean execution speed | | 0.08 µs/instruction | | | | |

¹ The slower speed is applicable when the HSC is configured for quadrature mode of operation.

² For CPU models with relay outputs, you must install a digital signal (SB) to use the pulse outputs.

The different CPU models provide a diversity of features and capabilities that help you create effective solutions for your varied applications. For detailed information about a specific CPU, see the technical specifications (Page 829).

Table 1- 2 Blocks, timers, and counters supported by S7-1200

| Element | Description | |
|-----------------------------|--------------------|---|
| Blocks | Type | OB, FB, FC, DB |
| | Size | 30 Kbytes (CPU 1211C) 50 Kbytes (CPU 1212C) 64 Kbytes (CPU 1214C, CPU 1215C, and CPU 1217C) |
| | Quantity | Up to 1024 blocks total (OBs + FBs + FCs + DBs) |
| | Nesting depth | 16 from the program cycle or startup OB; 6 from any interrupt event OB |
| | Monitoring | Status of 2 code blocks can be monitored simultaneously |
| | OBs | Program cycle |
| Startup | | Multiple |
| Time-delay interrupts | | 4 (1 per event) |
| Cyclic interrupts | | 4 (1 per event) |
| Hardware interrupts | | 50 (1 per event) |
| Time error interrupts | | 1 |
| Diagnostic error interrupts | | 1 |
| Pull or plug of modules | | 1 |
| Rack or station failure | | 1 |
| Time of day | | Multiple |
| Status | | 1 |
| Update | | 1 |
| Profile | | 1 |
| Timers | Type | IEC |
| | Quantity | Limited only by memory size |
| | Storage | Structure in DB, 16 bytes per timer |
| Counters | Type | IEC |
| | Quantity | Limited only by memory size |
| | Storage | Structure in DB, size dependent upon count type <ul style="list-style-type: none"> • SInt, USInt: 3 bytes • Int, UInt: 6 bytes • DInt, UDInt: 12 bytes |

1.2 Expansion capability of the CPU

The S7-1200 family provides a variety of modules and plug-in boards for expanding the capabilities of the CPU with additional I/O or other communication protocols. For detailed information about a specific module, see the technical specifications (Page 829).

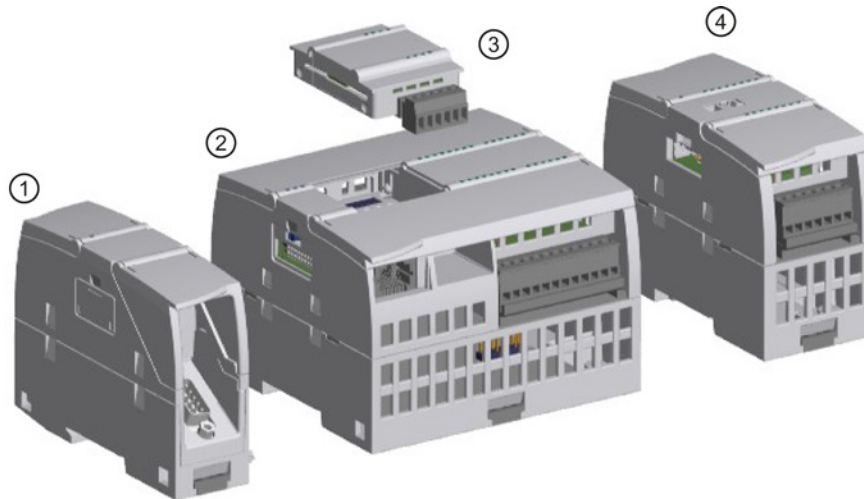

- ① Communication module (CM or communication processor (CP))
- ② CPU
- ③ Signal board (SB), communication board (CB), or Battery Board (BB)
- ④ Signal module (SM)

Table 1-3 Digital signal modules and signal boards

| Type | Input only | Output only | Combination In/Out |
|--------------|---|---|--|
| ③ digital SB | <ul style="list-style-type: none"> • 4 x 24 VDC In, 200 kHz • 4 x 5 VDC In, 200 kHz | <ul style="list-style-type: none"> • 4 x 24 VDC Out, 200 kHz • 4 x 5 VDC Out, 200 kHz | <ul style="list-style-type: none"> • 2 x 24 VDC In/2 x 24 VDC Out • 2 x 24 VDC In/2 x 24 VDC Out, 200 kHz • 2 x 5 VDC In/2 x 5 VDC Out, 200 kHz |
| ④ digital SM | <ul style="list-style-type: none"> • 8 x 24 VDC In | <ul style="list-style-type: none"> • 8 x 24 VDC Out • 8 x Relay Out • 8 x Relay Out (Changeover) | <ul style="list-style-type: none"> • 8 x 24 VDC In/8 x 24 VDC Out • 8 x 24 VDC In/8 x Relay Out • 8 x 120/230 VAC In/8 x Relay Out |
| | <ul style="list-style-type: none"> • 16 x 24 VDC In | <ul style="list-style-type: none"> • 16 x 24 VDC Out • 16 x Relay Out | <ul style="list-style-type: none"> • 16 x 24 VDC In/16 x 24 VDC Out • 16 x 24 VDC In/16 x Relay Out |

Table 1- 4 Analog signal modules and signal boards

| Type | Input only | Output only | Combination In/Out |
|-------------|---|--|--|
| ③ analog SB | <ul style="list-style-type: none"> • 1 x 12 bit Analog In • 1 x 16 bit RTD • 1 x 16 bit Thermocouple | <ul style="list-style-type: none"> • 1 x Analog Out | - |
| ④ analog SM | <ul style="list-style-type: none"> • 4 x Analog In • 4 x Analog In x 16 bit • 8 x Analog In • Thermocouple: <ul style="list-style-type: none"> - 4 x 16 bit TC - 8 x 16 bit TC • RTD: <ul style="list-style-type: none"> - 4 x 16 bit RTD - 8 x 16 bit RTD | <ul style="list-style-type: none"> • 2 x Analog Out • 4 x Analog Out | <ul style="list-style-type: none"> • 4 x Analog In/2 x Analog Out |

Table 1- 5 Communication interfaces

| Module | Type | Description |
|--------------------------------|-------------------------|--|
| ① Communication module (CM) | RS232 | Full-duplex |
| | RS422/485 | Full-duplex (RS422) Half-duplex (RS485) |
| | PROFIBUS Master | DPV1 |
| | PROFIBUS Slave | DPV1 |
| | AS-i Master (CM 1243-2) | AS-Interface |
| ① Communication processor (CP) | Modem connectivity | GPRS |
| ③ Communication board (CB) | RS485 | Half-duplex |
| TeleService ¹ | TS Adapter IE Basic | Connection to CPU |
| | TS Adapter GSM | GSM/GPRS |
| | TS Adapter Modem | Modem |
| | TS Adapter ISDN | ISDN |
| | TS Adapter RS232 | RS232 |

¹ The TS Adapter IE Basic allows you to connect various communication interfaces to the PROFINET port of the CPU using an Ethernet cable. You can install up to 3 TS adapter modules onto the TS Adapter IE Basic.

Table 1- 6 Technology modules

| Module | Type | Description |
|-----------|--------------------------|---------------------------|
| ④ IO Link | SM 1278 4xIO-Link Master | Supports 4 IO link slaves |

1.2 Expansion capability of the CPU

Table 1-7 Other boards

| Module | Description |
|-----------------|---|
| ③ Battery board | Plugs into expansion board interface on front of CPU. Provides long term backup of realtime clock |

1.3 S7-1200 modules

Table 1- 8 S7-1200 expansion modules

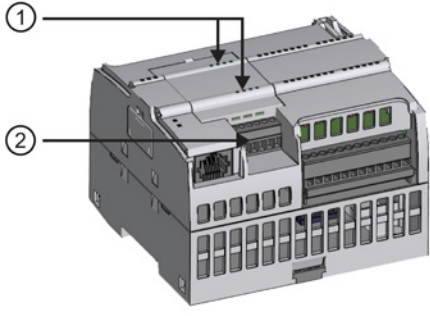
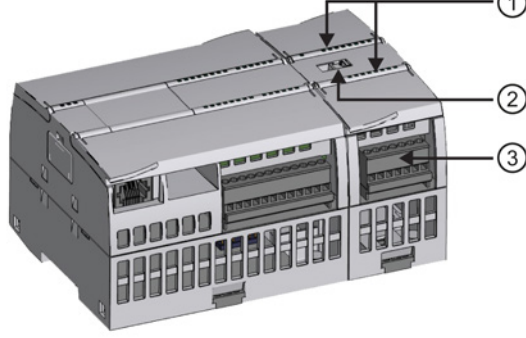
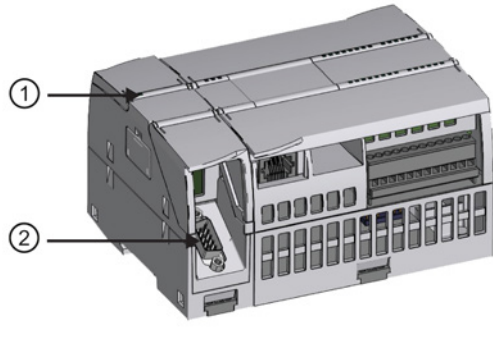
| Type of module | Description | | | | | | | |
|--|--|--|---|-----------------------|---|---------------------------------|---|---------------------------------|
| <p>The CPU supports one plug-in expansion board:</p> <ul style="list-style-type: none"> • A signal board (SB) provides additional I/O for your CPU. The SB connects on the front of the CPU. • A communication board (CB) allows you to add another communication port to your CPU. • A battery board (BB) allows you to provide long term backup of the realtime clock. |  | <table border="1"> <tr> <td data-bbox="1198 488 1267 555">①</td> <td data-bbox="1267 488 1476 555">Status LEDs on the SB</td> </tr> <tr> <td data-bbox="1198 555 1267 929">②</td> <td data-bbox="1267 555 1476 929">Removable user wiring connector</td> </tr> </table> | ① | Status LEDs on the SB | ② | Removable user wiring connector | | |
| ① | Status LEDs on the SB | | | | | | | |
| ② | Removable user wiring connector | | | | | | | |
| <p>Signal modules (SMs) add additional functionality to the CPU. SMs connect to the right side of the CPU.</p> <ul style="list-style-type: none"> • Digital I/O • Analog I/O • RTD and thermocouple • SM 1278 IO-Link Master |  | <table border="1"> <tr> <td data-bbox="1198 943 1267 981">①</td> <td data-bbox="1267 943 1476 981">Status LEDs</td> </tr> <tr> <td data-bbox="1198 981 1267 1048">②</td> <td data-bbox="1267 981 1476 1048">Bus connector slide tab</td> </tr> <tr> <td data-bbox="1198 1048 1267 1355">③</td> <td data-bbox="1267 1048 1476 1355">Removable user wiring connector</td> </tr> </table> | ① | Status LEDs | ② | Bus connector slide tab | ③ | Removable user wiring connector |
| ① | Status LEDs | | | | | | | |
| ② | Bus connector slide tab | | | | | | | |
| ③ | Removable user wiring connector | | | | | | | |
| <p>Communication modules (CMs) and communications processors (CPs) add communication options to the CPU, such as for PROFIBUS or RS232/RS485 connectivity (for PtP, Modbus or USS), or the AS-i master. A CP provides capabilities for other types of communication, such as to connect the CPU over a GPRS network.</p> <ul style="list-style-type: none"> • The CPU supports up to 3 CMs or CPs • Each CM or CP connects to the left side of the CPU (or to the left side of another CM or CP) |  | <table border="1"> <tr> <td data-bbox="1198 1368 1267 1406">①</td> <td data-bbox="1267 1368 1476 1406">Status LEDs</td> </tr> <tr> <td data-bbox="1198 1406 1267 1861">②</td> <td data-bbox="1267 1406 1476 1861">Communication connector</td> </tr> </table> | ① | Status LEDs | ② | Communication connector | | |
| ① | Status LEDs | | | | | | | |
| ② | Communication connector | | | | | | | |

1.4 New features

The following features are new in this release:

- The S7-1200 supports new Organization Blocks (OBs) (Page 85) with differences in priority levels and interrupts (Page 94).
- The Web server (Page 601) now supports the display of standard Web pages and user-defined Web pages from a mobile device as well as from a PC. The standard Web pages are available in English, German, French, Spanish, Italian, and Simplified Chinese with this release.
- The "Download in Run" (Page 803) feature now supports a maximum of twenty blocks that you can download in RUN mode. You can also add tags and modify tags in existing data blocks and function blocks and download the modified data blocks in RUN mode.
- The online and diagnostic tools of STEP 7 provide the means to perform a firmware update (Page 791) of your CPU, signal modules, communication modules, and attached signal or communication board.
- STEP 7 includes a trace and logic analyzer function (Page 813) that you can use with the V4.0 S7-1200 CPUs. With this feature, you can configure specific data that you want to trace and record when the CPU meets a trigger condition that you define. The CPU stores the recorded data, and STEP 7 provides tools for retrieving and analyzing the recorded data.
- New programming instructions:
 - **Set tag on signal edge:** R_TRIG (Page 209), F_TRIG (Page 209)
 - **Write local time:** WR_LOC_T (Page 286)
 - **String maximum length:** MAX_LEN (Page 306)
 - **Time of day interrupts:** SET_TINTL (Page 337), CAN_TINT (Page 339), ACT_TINT (Page 339), QRY_TINT (Page 340)
 - **Process recipes:** RecipeExport (Page 374), RecipeImport (Page 376)
 - **Address handling:** LOG2GEO (Page 404), RD_ADDR (Page 406)
 - **Motion control:** MC_WriteParam (Page 478), MC_ReadParam (Page 480)
 - **Enable / disable password:** ENDIS_PW (Page 259)
- HSC (Page 411) improvements to allow any HSC instruction input or output to be assigned to any built-in or SB digital input
- PTO/PWM (Page 481) improvements to allow any PTO/PWM instruction input or output to be assigned to any built-in or SB digital output
- Enhanced library (Page 177) features, including versioning

New modules for the S7-1200

New modules expand the power of the S7-1200 CPU and provide the flexibility to meet your automation needs:

- New CPU 1217C DC/DC/DC (Page 879) with high-speed differential points
- New and improved S7-1200 signal modules. The new signal modules (6ES7 2xx-xxx32-0XB0) replace existing signal modules (6ES7 2xx-xxx30-0XB0). The new modules provide:
 - 4-20 mA range added to analog input and output modules
 - Wirebreak detection when using 4-20 mA added to analog input modules
 - Connector keying to prevent errors when plugging in field wiring connectors added to modules with relay outputs
 - Spare parts compatibility: you can employ the revised module in place of existing modules without any changes.
- New spare parts (Page 993) available for use with S7-1200 CPUs
- New CPU 1217C Input Simulator (Page 978) (6ES7 274-1XK30-0XA0)
- New SM 1278 4xIO-Link Master (Page 815) (6ES7 278-4BD32-0XB0) functions as both a signal module and a communication module, and allows connection of up to 4 IO-Link slaves (3-wire connection) or 4 standard actuators or standard encoders
- New S7-1200 Potentiometer module (Page 980) (6ES7 274-1XA30-0XA0)
- New CM CANopen for S7-1200 (Page 983) is a plug-in module that allows you to connect CANopen devices to the S7-1200 PLC. It can be configured to be both master or slave.

Exchanging your V3.0 CPU for a V4.0 CPU

If you are replacing an S7-1200 V3.0 CPU with an S7-1200 V4.0 CPU, take note of the documented differences (Page 995) in the versions.

1.5 Basic HMI panels

The SIMATIC HMI Basic Panels provide touch-screen devices for basic operator control and monitoring tasks. All panels have a protection rating for IP65 and have CE, UL, cULus, and NEMA 4x certification.

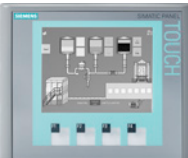
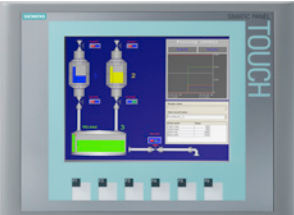
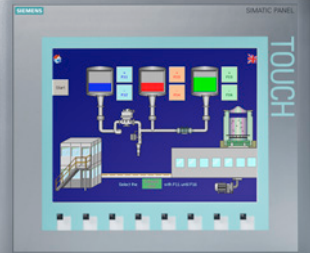
| Basic HMI Panel | Description | Technical data |
|--|---|--|
|  <p>KP 300 Basic PN</p> | <p>3.6" membrane keyboard with 10 freely configurable tactile keys</p> <ul style="list-style-type: none"> • Mono (STN, black/white) • 87 mm x 31 mm (3.6") • Backlight color programmed (white, green, yellow, or red) • Resolution: 240 x 80 | <ul style="list-style-type: none"> • 250 tags • 50 process screens • 200 alarms • 25 curves • 40 KB recipe memory • 5 recipes, 20 data records, 20 entries |
|  <p>KTP 400 Basic PN</p> | <p>4" touch screen with 4 tactile keys</p> <ul style="list-style-type: none"> • Mono (STN, gray scale) • 76.79 mm x 57.59 mm (3.8") Portrait or landscape • Resolution: 320 x 240 | <ul style="list-style-type: none"> • 250 tags • 50 process screens • 200 alarms • 25 curves • 40 KB recipe memory • 5 recipes, 20 data records, 20 entries |
|  <p>KTP 600 Basic PN</p> | <p>6" touch screen with 6 tactile keys</p> <ul style="list-style-type: none"> • Color (TFT, 256 colors) or Mono (STN, gray scales) • 115.2 mm x 86.4 mm (5.7") Portrait or landscape • Resolution: 320 x 240 | <ul style="list-style-type: none"> • 500 tags • 50 process screens • 200 alarms • 25 curves • 40 KB recipe memory • 5 recipes, 20 data records, 20 entries |
|  <p>KTP 1000 Basic PN</p> | <p>10" touch screen with 8 tactile keys</p> <ul style="list-style-type: none"> • Color (TFT, 256 colors) • 211.2 mm x 158.4 mm (10.4") • Resolution: 640 x 480 | <ul style="list-style-type: none"> • 500 tags • 50 process screens • 200 alarms • 25 curves • 40 KB recipe memory • 5 recipes, 20 data records, 20 entries |

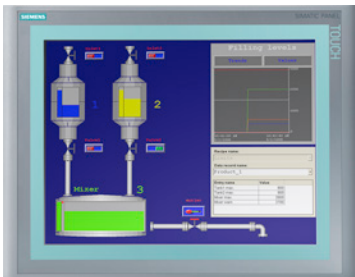
| Basic HMI Panel | Description | Technical data |
|---|--|--|
|  <p>TP 1500 Basic PN</p> | <p>15" touch screen</p> <ul style="list-style-type: none">• Color (TFT, 256 colors)• 304.1 mm x 228.1 mm (15.1")• Resolution: 1024 x 768 | <ul style="list-style-type: none">• 500 tags• 50 process screens• 200 alarms• 25 curves• 40 KB recipe memory (integrated flash)• 5 recipes, 20 data records, 20 entries |

See also

Customer support (<http://www.siemens.com/automation/>)

STEP 7 programming software

STEP 7 provides a user-friendly environment to develop, edit, and monitor the logic needed to control your application, including the tools for managing and configuring all of the devices in your project, such as controllers and HMI devices. To help you find the information you need, STEP 7 provides an extensive online help system.

STEP 7 provides standard programming languages for convenience and efficiency in developing the control program for your application.

- LAD (ladder logic) (Page 180) is a graphical programming language. The representation is based on circuit diagrams.
- FBD (Function Block Diagram) (Page 181) is a programming language that is based on the graphical logic symbols used in Boolean algebra.
- SCL (structured control language) (Page 181) is a text-based, high-level programming language.

When you create a code block, you select the programming language to be used by that block. Your user program can utilize code blocks created in any or all of the programming languages.

Note

STEP 7 is the programming and configuration software component of the TIA Portal. The TIA Portal, in addition to STEP 7, also includes WinCC for designing and executing runtime process visualization, and includes online help for WinCC as well as STEP 7.

2.1 System requirements

To install STEP 7, you must log in with Administrator privileges.

Table 2- 1 System requirements

| Hardware/software | Requirements |
|---------------------------|--|
| Processor type | Pentium M, 1.6 GHz or similar |
| RAM | 1 GB |
| Available hard disk space | 2 GB on system drive C:\ |
| Operating systems | <ul style="list-style-type: none">Windows 7 Home Premium or higher (STEP 7 Basic only, not supported for STEP 7 Professional)Windows 7 or higher (Professional, Enterprise, Ultimate) |
| Graphics card | 32 MB RAM 24-bit color depth |
| Screen resolution | 1024 x 768 |
| Network | 20 Mbit/s Ethernet or faster |
| Optical drive | DVD-ROM |

2.2 Different views to make the work easier

STEP 7 provides a user-friendly environment to develop controller logic, configure HMI visualization, and setup network communication. To help increase your productivity, STEP 7 provides two different views of the project: a task-oriented set of portals that are organized on the functionality of the tools (Portal view), or a project-oriented view of the elements within the project (Project view). Choose which view helps you work most efficiently. With a single click, you can toggle between the Portal view and the Project view.

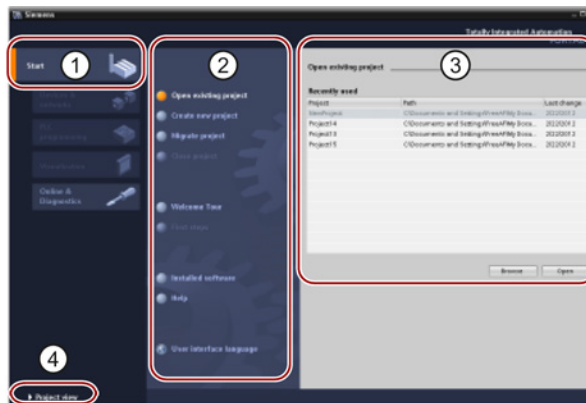

Portal view

- ① Portals for the different tasks
- ② Tasks for the selected portal
- ③ Selection panel for the selected action
- ④ Changes to the Project view

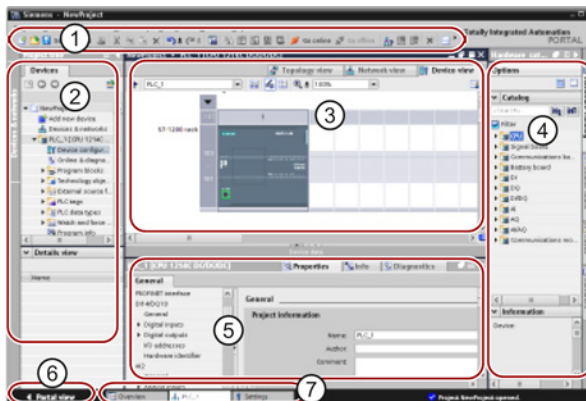

Project view

- ① Menus and toolbar
- ② Project navigator
- ③ Work area
- ④ Task cards
- ⑤ Inspector window
- ⑥ Changes to the Portal view
- ⑦ Editor bar

With all of these components in one place, you have easy access to every aspect of your project. For example, the inspector window shows the properties and information for the object that you have selected in the work area. As you select different objects, the inspector window displays the properties that you can configure. The inspector window includes tabs that allow you to see diagnostic information and other messages.

By showing all of the editors that are open, the editor bar helps you work more quickly and efficiently. To toggle between the open editors, simply click the different editor. You can also arrange two editors to appear together, arranged either vertically or horizontally. This feature allows you to drag and drop between editors.

2.3 Easy-to-use tools

2.3.1 Inserting instructions into your user program

STEP 7 provides task cards that contain the instructions for your program. The instructions are grouped according to function.



To create your program, you drag instructions from the task card onto a network.

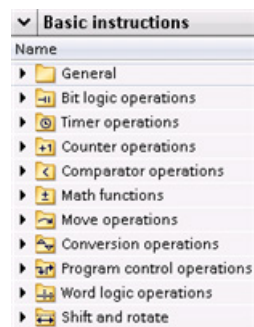

2.3.2 Accessing instructions from the "Favorites" toolbar

STEP 7 provides a "Favorites" toolbar to give you quick access to the instructions that you frequently use. Simply click the icon for the instruction to insert it into your network!

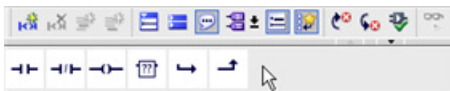

(For the "Favorites" in the instruction tree, double-click the icon.)

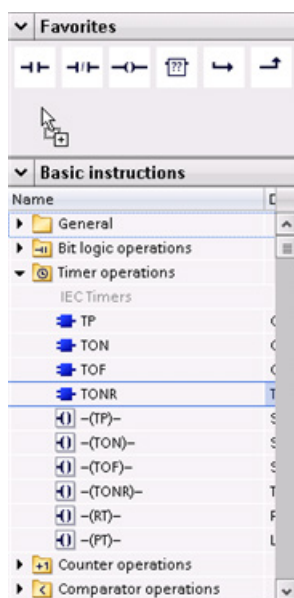

You can easily customize the "Favorites" by adding new instructions.

Simply drag and drop an instruction to the "Favorites".

The instruction is now just a click away!

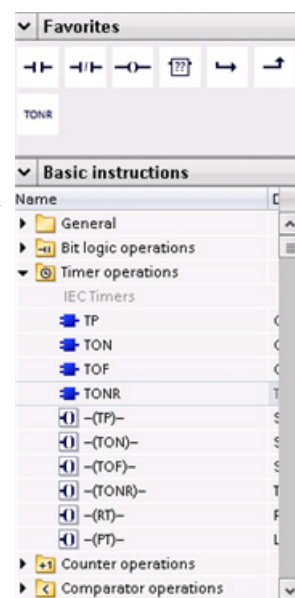

2.3.3 Creating a complex equation with a simple instruction

The Calculate instruction lets you create a math function that operates on multiple input parameters to produce the result, according to the equation that you define.

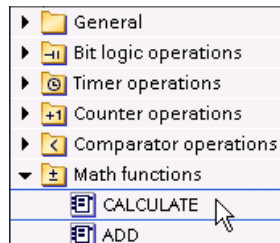

In the Basic instruction tree, expand the Math functions folder. Double-click the Calculate instruction to insert the instruction into your user program.

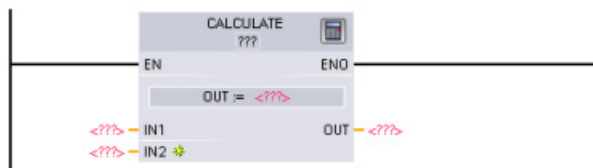

The unconfigured Calculate instruction provides two input parameters and an output parameter.

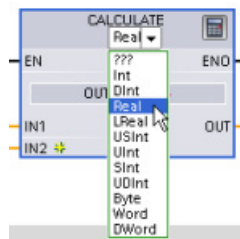

Click the "???" and select the data types for the input and output parameters. (The input and output parameters must all be the same data type.)

For this example, select the "Real" data type.



Click the "Edit equation" icon to enter the equation.

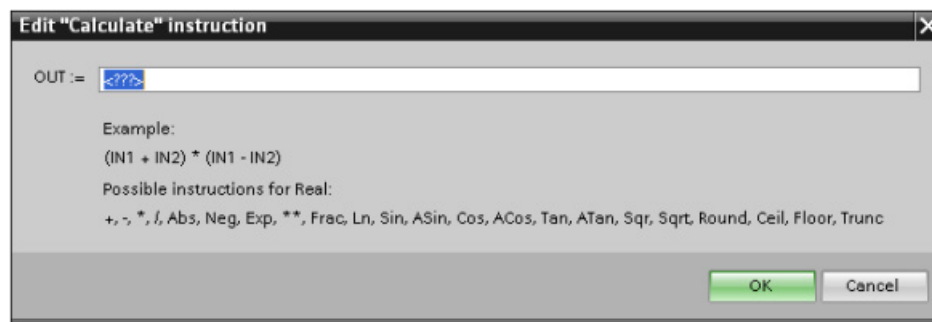

For this example, enter the following equation for scaling a raw analog value. (The "In" and "Out" designations correspond to the parameters of the Calculate instruction.)

$$\text{Out value} = ((\text{Out high} - \text{Out low}) / (\text{In high} - \text{In low})) * (\text{In value} - \text{In low}) + \text{Out low}$$

$$\text{Out} = ((\text{in4} - \text{in5}) / (\text{in2} - \text{in3})) * (\text{in1} - \text{in3}) + \text{in5}$$

Where: Out value (Out) Scaled output value

| | | |
|----------|-------|---|
| In value | (in1) | Analog input value |
| In high | (in2) | Upper limit for the scaled input value |
| In low | (in3) | Lower limit for the scaled input value |
| Out high | (in4) | Upper limit for the scaled output value |
| Out low | (in5) | Lower limit for the scaled output value |

In the "Edit Calculate" box, enter the equation with the parameter names:

$$OUT = ((in4 - in5) / (in2 - in3)) * (in1 - in3) + in5$$

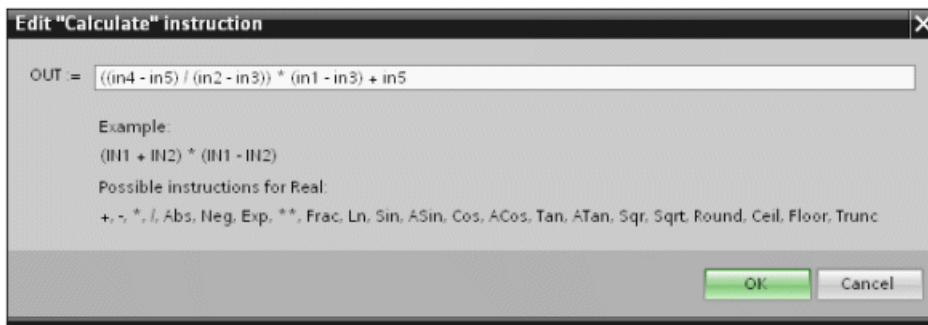

When you click "OK", the Calculate instruction creates the inputs required for the instruction.

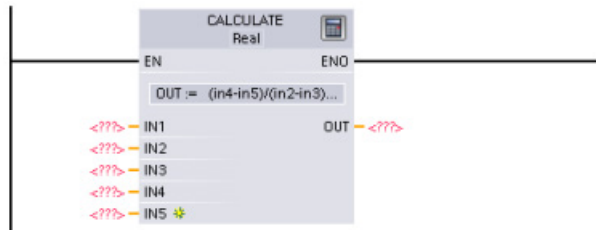

Enter the tag names for the values that correspond to the parameters.

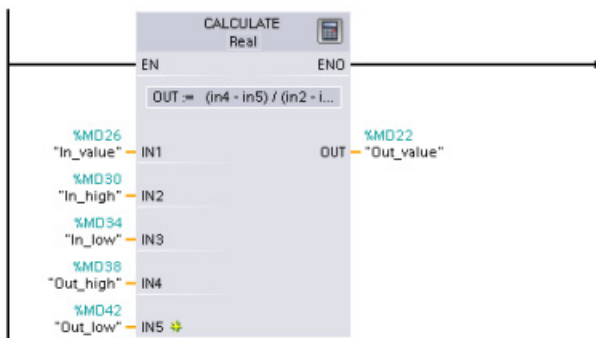

2.3.4 Adding inputs or outputs to a LAD or FBD instruction



Some of the instructions allow you to create additional inputs or outputs.

- To add an input or output, click the "Create" icon or right-click on an input stub for one of the existing IN or OUT parameters and select the "Insert input" command.
- To remove an input or output, right-click on the stub for one of the existing IN or OUT parameters (when there are more than the original two inputs) and select the "Delete" command.

2.3.5 Expandable instructions

Some of the more complex instructions are expandable, displaying only the key inputs and outputs. To display all the inputs and outputs, click the arrow at the bottom of the instruction.

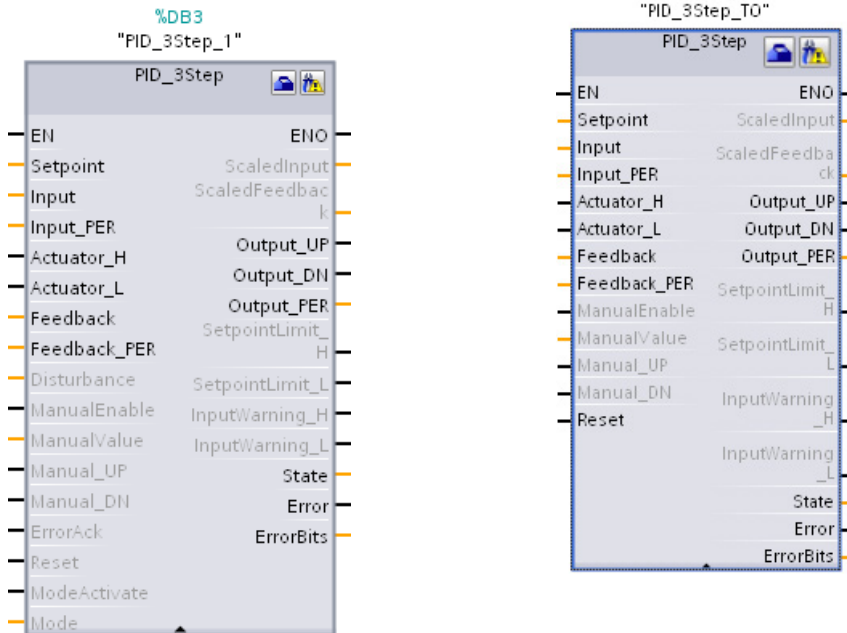

2.3.6 Selecting a version for an instruction

The development and release cycles for certain sets of instructions (such as Modbus, PID and motion) have created multiple released versions for these instructions. To help ensure compatibility and migration with older projects, STEP 7 allows you to choose which version of instruction to insert into your user program.

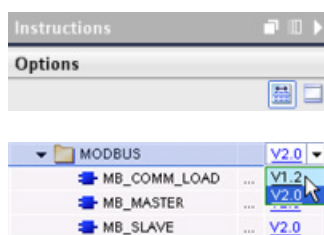

Click the icon on the instruction tree task card to enable the headers and columns of the instruction tree.

To change the version of the instruction, select the appropriate version from the drop-down list.

2.3.7 Modifying the appearance and configuration of STEP 7

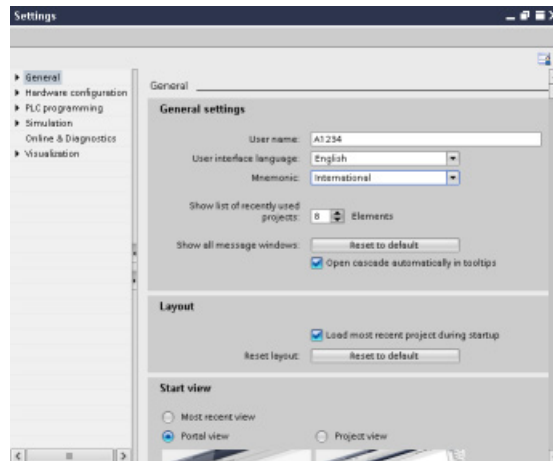

You can select a variety of settings, such as the appearance of the interface, language, or the folder for saving your work.

Select the "Settings" command from the "Options" menu to change these settings.

2.3.8 Dragging and dropping between editors

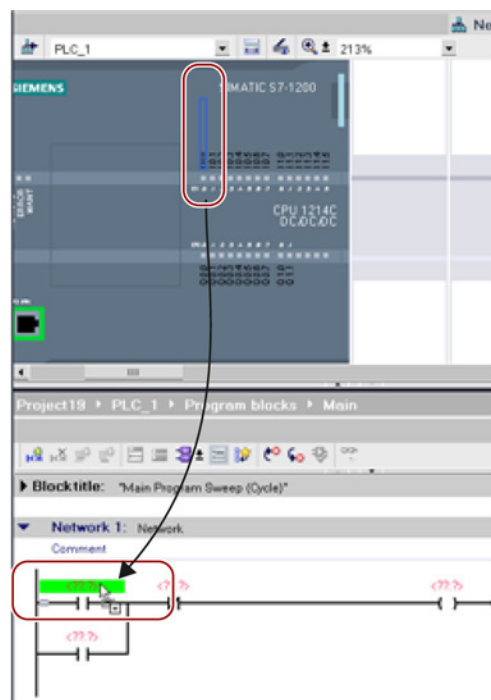

To help you perform tasks quickly and easily, STEP 7 allows you to drag and drop elements from one editor to another. For example, you can drag an input from the CPU to the address of an instruction in your user program.

You must zoom in at least 200% to select the inputs or outputs of the CPU.

Notice that the tag names are displayed not only in the PLC tag table, but also are displayed on the CPU.

To display two editors at one time, use the "Split editor" menu commands or buttons in the toolbar.

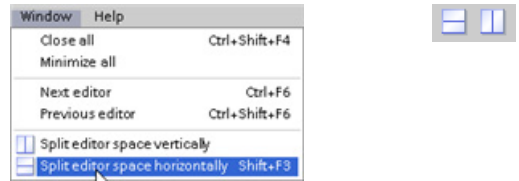

To toggle between the editors that have been opened, click the icons in the editor bar.



2.3.9 Changing the operating mode of the CPU

The CPU does not have a physical switch for changing the operating mode (STOP or RUN).

Use the "Start CPU" and "Stop CPU" toolbar buttons to change the operating mode of the CPU.



When you configure the CPU in the device configuration, you configure the start-up behavior in the properties of the CPU.

The "Online and diagnostics" portal also provides an operator panel for changing the operating mode of the online CPU. To use the CPU operator panel, you must be connected online to the CPU. The "Online tools" task card displays an operator panel that shows the operating mode of the online CPU. The operator panel also allows you to change the operating mode of the online CPU.

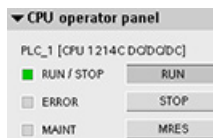

Use the button on the operator panel to change the operating mode (STOP or RUN). The operator panel also provides an MRES button for resetting the memory.

The color of the RUN/STOP indicator shows the current operating mode of the CPU. Yellow indicates STOP mode, and green indicates RUN mode.

Refer to Operating Modes of the CPU in the S7-1200 System Manual (Page 81) for configuring the default operating mode on power up.

2.3.10 Changing the call type for a DB

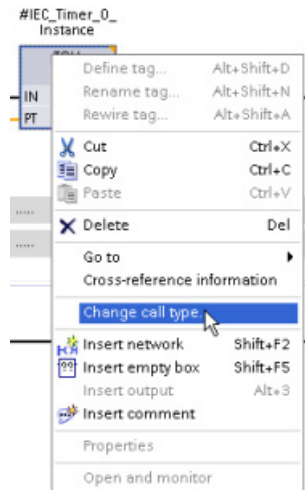

STEP 7 allows you to easily create or change the association of a DB for an instruction or an FB that is in an FB.

- You can switch the association between different DBs.
- You can switch the association between a single-instance DB and a multi-instance DB.
- You can create an instance DB (if an instance DB is missing or not available).

You can access the "Change call type" command either by right-clicking the instruction or FB in the program editor or by selecting the "Block call" command from the "Options" menu.

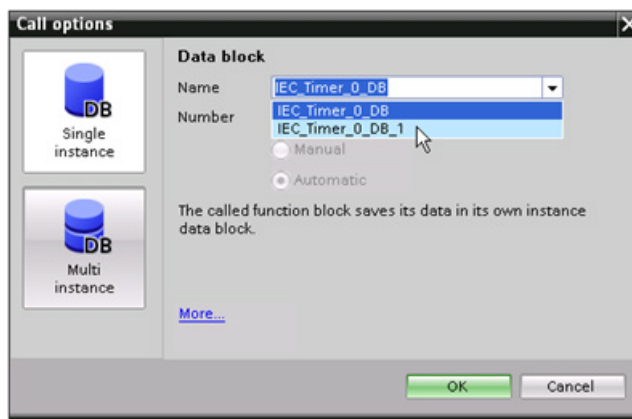

The "Call options" dialog allows you to select a single-instance or multi-instance DB. You can also select specific DBs from a drop-down list of available DBs.

2.3.11 Temporarily disconnecting devices from a network

You can disconnect individual network devices from the subnet. Because the configuration of the device is not removed from the project, you can easily restore the connection to the device.

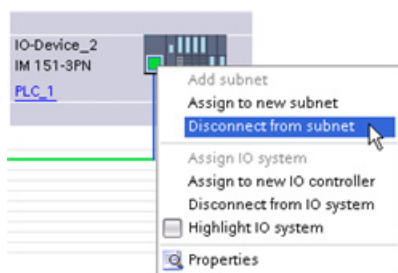
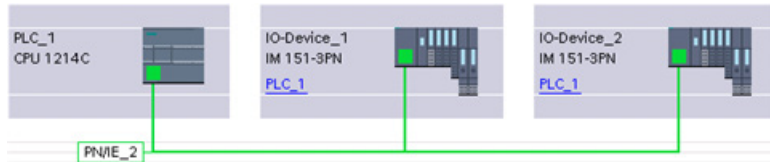

Right-click the interface port of the network device and select the "Disconnect from subnet" command from the context menu.

STEP 7 reconfigures the network connections, but does not remove the disconnected device from the project. While the network connection is deleted, the interface addresses are not changed.

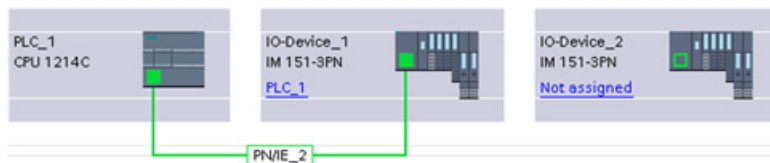

When you download the new network connections, the CPU must be set to STOP mode. To reconnect the device, simply create a new network connection to the port of the device.

2.3.12 Virtual unplugging of devices from the configuration

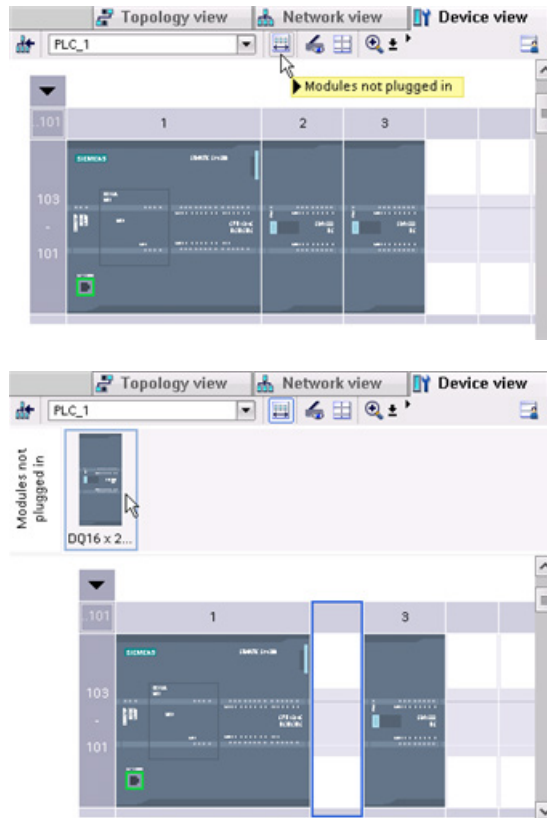

STEP 7 provides a storage area for "unplugged" modules. You can drag a module from the rack to save the configuration of that module. These unplugged modules are saved with your project, allowing you to reinsert the module in the future without having to reconfigure the parameters.

One use of this feature is for temporary maintenance. Consider a scenario where you might be waiting for a replacement module and plan to temporarily use a different module as a short-term replacement. You could drag the configured module from the rack to the "Unplugged modules" and then insert the temporary module.

Installation

3.1 Guidelines for installing S7-1200 devices

The S7-1200 equipment is designed to be easy to install. You can install an S7-1200 either on a panel or on a standard rail, and you can orient the S7-1200 either horizontally or vertically. The small size of the S7-1200 allows you to make efficient use of space.

 **WARNING**

Installation requirements for S7-1200 PLCs

The SIMATIC S7-1200 PLCs are Open Type Controllers. It is required that you install the S7-1200 in a housing, cabinet, or electric control room. Entry to the housing, cabinet, or electric control room should be limited to authorized personnel.

Failure to follow these installation requirements could result in death, severe personal injury and/or property damage.

Always follow these requirements when installing S7-1200 PLCs.

Separate the S7-1200 devices from heat, high voltage, and electrical noise

As a general rule for laying out the devices of your system, always separate the devices that generate high voltage and high electrical noise from the low-voltage, logic-type devices such as the S7-1200.

When configuring the layout of the S7-1200 inside your panel, consider the heat-generating devices and locate the electronic-type devices in the cooler areas of your cabinet. Reducing the exposure to a high-temperature environment will extend the operating life of any electronic device.

Consider also the routing of the wiring for the devices in the panel. Avoid placing low-voltage signal wires and communications cables in the same tray with AC power wiring and high-energy, rapidly-switched DC wiring.

3.1 Guidelines for installing S7-1200 devices

Provide adequate clearance for cooling and wiring

S7-1200 devices are designed for natural convection cooling. For proper cooling, you must provide a clearance of at least 25 mm above and below the devices. Also, allow at least 25 mm of depth between the front of the modules and the inside of the enclosure.

⚠ CAUTION

For vertical mounting, the maximum allowable ambient temperature is reduced by 10 degrees C.

Orient a vertically mounted S7-1200 system as shown in the following figure.

Ensure that the S7-1200 system is mounted correctly.

When planning your layout for the S7-1200 system, allow enough clearance for the wiring and communications cable connections.

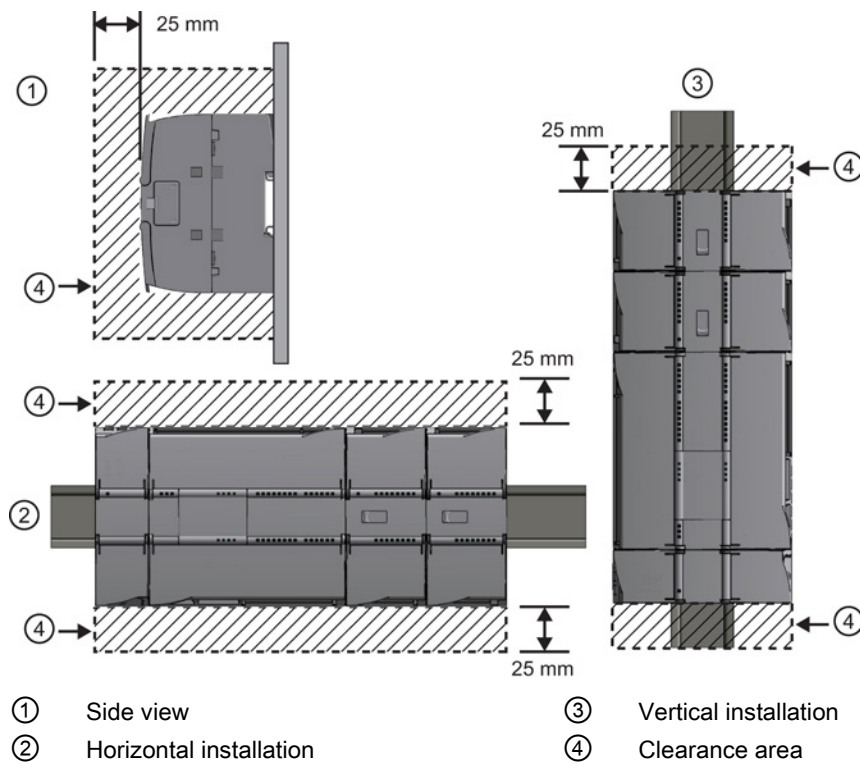

3.2 Power budget

Your CPU has an internal power supply that provides power for the CPU, the signal modules, signal board and communication modules and for other 24 VDC user power requirements.

Refer to the technical specifications (Page 829) for information about the 5 VDC logic budget supplied by your CPU and the 5 VDC power requirements of the signal modules, signal boards, and communication modules. Refer to the "Calculating a power budget" (Page 985) to determine how much power (or current) the CPU can provide for your configuration.

The CPU provides a 24 VDC sensor supply that can supply 24 VDC for input points, for relay coil power on the signal modules, or for other requirements. If your 24 VDC power requirements exceed the budget of the sensor supply, then you must add an external 24 VDC power supply to your system. Refer to the technical specifications (Page 829) for the 24 VDC sensor supply power budget for your particular CPU.

Note

The CM 1243-5 (PROFIBUS master module) requires power from the 24 VDC sensor supply of the CPU.

If you require an external 24 VDC power supply, ensure that the power supply is not connected in parallel with the sensor supply of the CPU. For improved electrical noise protection, it is recommended that the commons (M) of the different power supplies be connected.

| |
|--|
|  WARNING |
|--|

| |
|--|
| <p>Connecting an external 24 VDC power supply in parallel with the 24 VDC sensor supply can result in a conflict between the two supplies as each seeks to establish its own preferred output voltage level</p> |
|--|

| |
|---|
| <p>The result of this conflict can be shortened lifetime or immediate failure of one or both power supplies, with consequent unpredictable operation of the PLC system. Unpredictable operation could result in death, severe personal injury and/or property damage.</p> |
|---|

| |
|---|
| <p>The DC sensor supply and any external power supply should provide power to different points.</p> |
|---|

Some of the 24 VDC power input ports in the S7-1200 system are interconnected, with a common logic circuit connecting multiple M terminals. For example, the following circuits are interconnected when designated as "not isolated" in the data sheets: the 24 VDC power supply of the CPU, the power input for the relay coil of an SM, or the power supply for a non-isolated analog input. All non-isolated M terminals must connect to the same external reference potential.



WARNING

Connecting non-isolated M terminals to different reference potentials will cause unintended current flows that may cause damage or unpredictable operation in the PLC and any connected equipment.

Failure to comply with these guidelines could cause damage or unpredictable operation which could result in death or severe personal injury and/or property damage.

Always ensure that all non-isolated M terminals in an S7-1200 system are connected to the same reference potential.

3.3 Installation and removal procedures

3.3.1 Mounting dimensions for the S7-1200 devices

CPU 1211C, CPU 1212C, CPU 1214C
(measurements in mm)

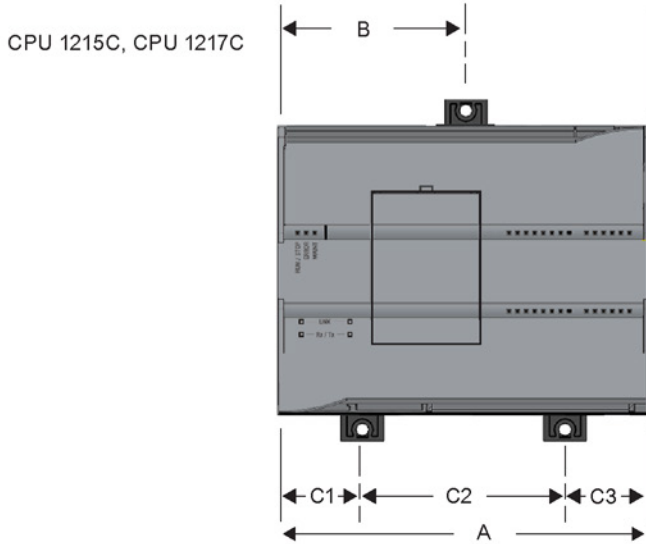
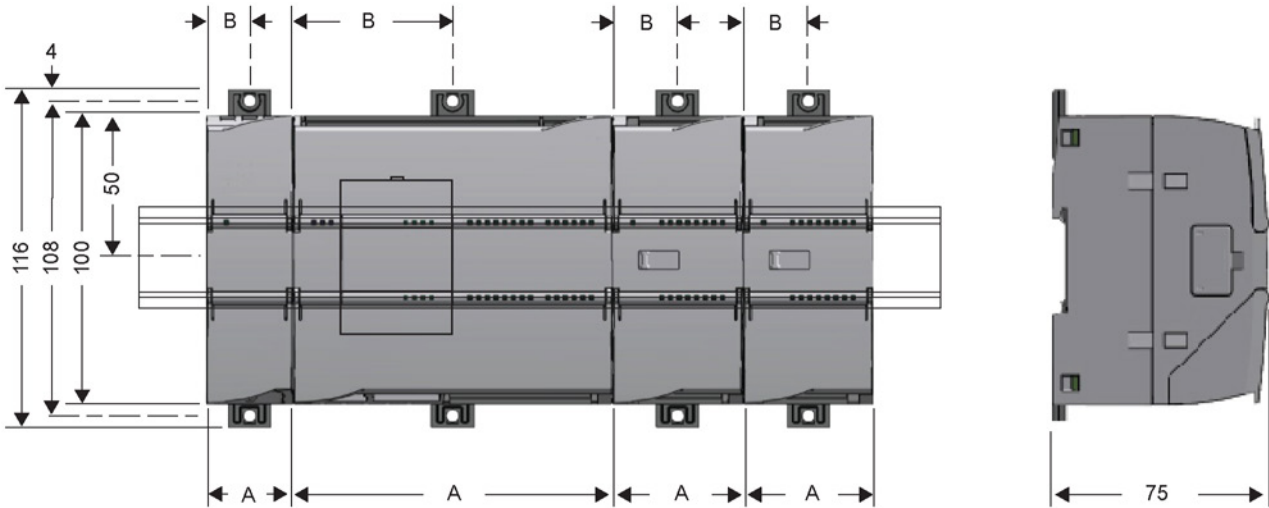

3.3 Installation and removal procedures

Table 3- 1 Mounting dimensions (mm)

| S7-1200 Devices | | Width A (mm) | Width B (mm) | Width C (mm) |
|--------------------------|---|--------------|--------------|---|
| CPU | CPU 1211C and CPU 1212C | 90 | 45 | -- |
| | CPU 1214C | 110 | 55 | -- |
| | CPU 1215C | 130 | 65 (top) | Bottom: C1: 32.5 C2: 65 C3: 32.5 |
| | CPU 1217C | 150 | 75 | Bottom: C1: 37.5 C2: 75 C3: 37.5 |
| Signal modules | Digital 8 and 16 point Analog 2, 4, and 8 point Thermocouple 4 and 8 point RTD 4 point SM 1278 IO Link-Master | 45 | 22.5 | -- |
| | Digital DQ 8 x Relay (Changeover) | 70 | 35 | -- |
| | Analog 16 point RTD 8 point | 70 | 35 | -- |
| Communication interfaces | CM 1241 RS232, and CM 1241 RS422/485 CM 1243-5 PROFIBUS master and CM 1242-5 PROFIBUS slave CM 1242-2 AS-i Master CP 1242-7 GPRS | 30 | 15 | -- |
| | TS (Teleservice) Adapter IE Basic ¹ | | | |
| | TS Adapter | 30 | 15 | -- |
| | TS Module | 30 | 15 | -- |

¹ Before installing the TS (Teleservice) Adapter IE Basic, you must first connect the TS Adapter and a TS module. The total width ("width A") is 60 mm.

Each CPU, SM, CM, and CP supports mounting on either a DIN rail or on a panel. Use the DIN rail clips on the module to secure the device on the rail. These clips also snap into an extended position to provide screw mounting positions to mount the unit directly on a panel. The interior dimension of the hole for the DIN clips on the device is 4.3 mm.

A 25 mm thermal zone must be provided above and below the unit for free air circulation.

Installing and removing the S7-1200 devices

The CPU can be easily installed on a standard DIN rail or on a panel. DIN rail clips are provided to secure the device on the DIN rail. The clips also snap into an extended position to provide a screw mounting position for panel-mounting the unit.

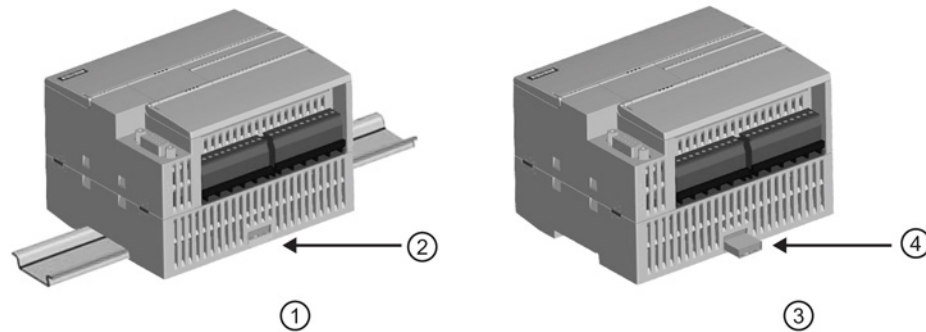

- | | |
|-------------------------------------|--|
| ① DIN rail installation | ③ Panel installation |
| ② DIN rail clip in latched position | ④ Clip in extended position for panel mounting |

Before you install or remove any electrical device, ensure that the power to that equipment has been turned off. Also, ensure that the power to any related equipment has been turned off.

WARNING

Installation or removal of S7-1200 or related equipment with the power applied could cause electric shock or unexpected operation of equipment.

Failure to disable all power to the S7-1200 and related equipment during installation or removal procedures could result in death, severe personal injury and/or property damage due to electric shock or unexpected equipment operation.

Always follow appropriate safety precautions and ensure that power to the S7-1200 is disabled before attempting to install or remove S7-1200 CPUs or related equipment.

Always ensure that whenever you replace or install an S7-1200 device you use the correct module or equivalent device.

WARNING

Incorrect installation of an S7-1200 module may cause the program in the S7-1200 to function unpredictably.

Failure to replace an S7-1200 device with the same model, orientation, or order could result in death, severe personal injury and/or property damage due to unexpected equipment operation.

Replace an S7-1200 device with the same model, and be sure to orient and position it correctly.

 **WARNING**

Do not disconnect equipment when a flammable or combustible atmosphere is present.

Disconnection of equipment when a flammable or combustible atmosphere is present may cause a fire or explosion which could result in death, serious injury and/or property damage.

Always follow appropriate safety precautions when a flammable or combustible atmosphere is present.

Note

Electrostatic discharge can damage the device or the receptacle on the CPU.

Make contact with a grounded conductive pad and/or wear a grounded wrist strap whenever you handle the device.

3.3.2 Installing and removing the CPU

You can install the CPU on a panel or on a DIN rail.

Note

Attach any communication modules to the CPU and install the assembly as a unit. Install signal modules separately after the CPU has been installed.

Consider the following when installing the units on the DIN rail or on a panel:

- For DIN rail mounting, make sure the upper DIN rail clip is in the latched (inner) position and that the lower DIN rail clip is in the extended position for the CPU and attached CMs.
- After installing the devices on the DIN rail, move the lower DIN rail clips to the latched position to lock the devices on the DIN rail.
- For panel mounting, make sure the DIN rail clips are pushed to the extended position.

To install the CPU on a panel, follow these steps:

1. Locate, drill, and tap the mounting holes (M4), using the dimensions shown in table, Mounting dimensions (mm) (Page 53).
2. Ensure that the CPU and all S7-1200 equipment are disconnected from electrical power.
3. Extend the mounting clips from the module. Make sure the DIN rail clips on the top and bottom of the CPU are in the extended position.
4. Secure the module to the panel, using a Pan Head M4 screw with spring and flat washer. Do not use a flat head screw.



Note

The type of screw will be determined by the material upon which it is mounted. You should apply appropriate torque until the spring washer becomes flat. Avoid applying excessive torque to the mounting screws. Do not use a flat head screw.

Note



Using DIN rail stops could be helpful if your CPU is in an environment with high vibration potential or if the CPU has been installed vertically. Use an end bracket (8WA1 808 or 8WA1 805) on the DIN rail to ensure that the modules remain connected. If your system is in a high-vibration environment, then panel-mounting the CPU will provide a greater level of vibration protection.

Table 3- 2 Installing the CPU on a DIN rail

| Task | Procedure |
|---|---|
|  | <ol style="list-style-type: none"> 1. Install the DIN rail. Secure the rail to the mounting panel every 75 mm. 2. Ensure that the CPU and all S7-1200 equipment are disconnected from electrical power. 3. Hook the CPU over the top of the DIN rail. 4. Pull out the DIN rail clip on the bottom of the CPU to allow the CPU to fit over the rail. |
|  | <ol style="list-style-type: none"> 5. Rotate the CPU down into position on the rail. 6. Push in the clips to latch the CPU to the rail. |

3.3 Installation and removal procedures

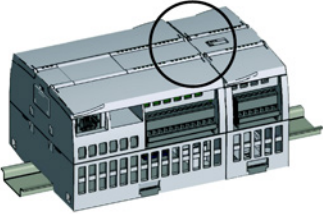
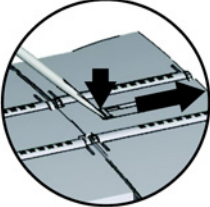
Table 3- 3 Removing the CPU from a DIN rail

| Task | Procedure | |
|---|---|---|
|  |  | <ol style="list-style-type: none"> 1. Ensure that the CPU and all S7-1200 equipment are disconnected from electrical power. 2. Disconnect the I/O connectors, wiring, and cables from the CPU (Page 63). 3. Remove the CPU and any attached communication modules as a unit. All signal modules should remain installed. |
|  | <ol style="list-style-type: none"> 4. If an SM is connected to the CPU, retract the bus connector: <ul style="list-style-type: none"> – Place a screwdriver beside the tab on the top of the signal module. – Press down to disengage the connector from the CPU. – Slide the tab fully to the right. 5. Remove the CPU: <ul style="list-style-type: none"> – Pull out the DIN rail clip to release the CPU from the rail. – Rotate the CPU up and off the rail, and remove the CPU from the system. | |

3.3.3 Installing and removing an SB, CB, or BB

Table 3- 4 Installing an SB, CB, or BB 1297

| Task | Procedure | |
|---|--|---|
|  | <ol style="list-style-type: none"> 1. Ensure that the CPU and all S7-1200 equipment are disconnected from electrical power. 2. Remove the top and bottom terminal block covers from the CPU. 3. Place a screwdriver into the slot on top of the CPU at the rear of the cover. 4. Gently pry the cover up and remove it from the CPU. | |
|  |  | <ol style="list-style-type: none"> 5. Place the module straight down into its mounting position in the top of the CPU. 6. Firmly press the module into position until it snaps into place. 7. Replace the terminal block covers. |

Table 3- 5 Removing an SB, CB or BB 1297

| Task | Procedure |
|---|---|
|  | <ol style="list-style-type: none"> 1. Ensure that the CPU and all S7-1200 equipment are disconnected from electrical power. 2. Remove the top and bottom terminal block covers from the CPU. 3. Place a screwdriver into the slot on top of the module. 4. Gently pry the module up to disengage it from the CPU. 5. Remove the module straight up from its mounting position in the top of the CPU. |
|  | <ol style="list-style-type: none"> 6. Replace the cover onto the CPU. 7. Replace the terminal block covers. |

Installing or replacing the battery in the BB 1297 battery board

The BB 1297 requires battery type CR1025. The battery is not included with the BB 1297 and must be purchased. To install or replace the battery, follow these steps:

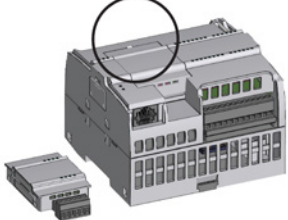
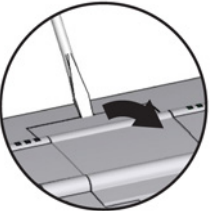
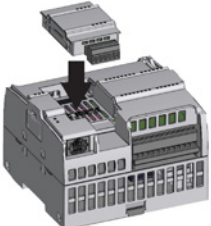
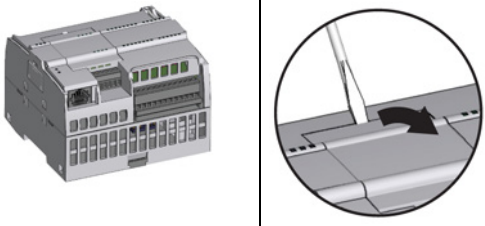
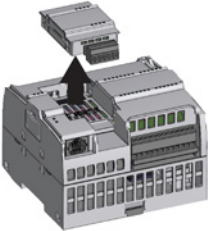
1. In the BB 1297, install a new battery with the positive side of the battery on top, and the negative side next to the printed wiring board.
2. The BB 1297 is ready to be installed in the CPU. Follow the installation directions above to install the BB 1297.

To replace the battery in the BB 1297:

1. Remove the BB 1297 from the CPU following the removal directions above.
2. Carefully remove the old battery using a small screwdriver. Push the battery out from under the clip.
3. Install a new CR1025 replacement battery with the positive side of the battery on top and the negative side next to the printed wiring board.
4. Re-install the BB 1297 battery board following the installation directions above.

3.3.4 Installing and removing an SM

Table 3- 6 Installing an SM



| Task | Procedure | |
|---|---|--|
|  |  | <p>Install your SM after installing the CPU.</p> <ol style="list-style-type: none"> 1. Ensure that the CPU and all S7-1200 equipment are disconnected from electrical power. 2. Remove the cover for the connector from the right side of the CPU: <ul style="list-style-type: none"> – Insert a screwdriver into the slot above the cover. – Gently pry the cover out at its top and remove the cover. 3. Retain the cover for reuse. |
|  |  | <p>Connect the SM to the CPU:</p> <ol style="list-style-type: none"> 1. Position the SM beside the CPU. 2. Hook the SM over the top of the DIN rail. 3. Pull out the bottom DIN rail clip to allow the SM to fit over the rail. 4. Rotate the SM down into position beside the CPU and push the bottom clip in to latch the SM onto the rail. |
|  | <p>Extending the bus connector makes both mechanical and electrical connections for the SM.</p> <ol style="list-style-type: none"> 1. Place a screwdriver beside the tab on the top of the SM. 2. Slide the tab fully to the left to extend the bus connector into the CPU. <p>Follow the same procedure to install a signal module to a signal module.</p> | |

Table 3- 7 Removing an SM

| Task | Procedure |
|---|---|
|  | <p>You can remove any SM without removing the CPU or other SMs in place.</p> <ol style="list-style-type: none"> 1. Ensure that the CPU and all S7-1200 equipment are disconnected from electrical power. 2. Remove the I/O connectors and wiring from the SM (Page 63). 3. Retract the bus connector. <ul style="list-style-type: none"> – Place a screwdriver beside the tab on the top of the SM. – Press down to disengage the connector from the CPU. – Slide the tab fully to the right. <p>If there is another SM to the right, repeat this procedure for that SM.</p> |
|  | <p>Remove the SM:</p> <ol style="list-style-type: none"> 1. Pull out the bottom DIN rail clip to release the SM from the rail. 2. Rotate the SM up and off the rail. Remove the SM from the system. 3. If required, cover the bus connector on the CPU to avoid contamination. <p>Follow the same procedure to remove a signal module from a signal module.</p> |

3.3.5 Installing and removing a CM or CP

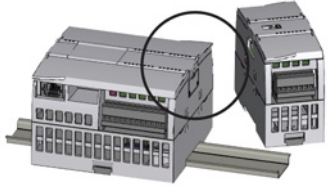
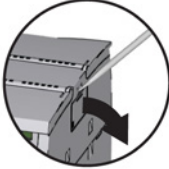
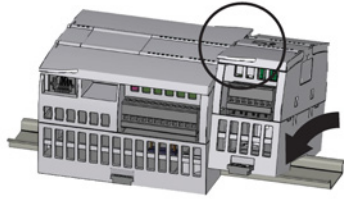
Attach any communication modules to the CPU and install the assembly as a unit, as shown in Installing and removing the CPU (Page 56).

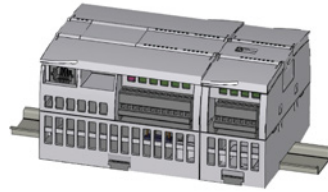
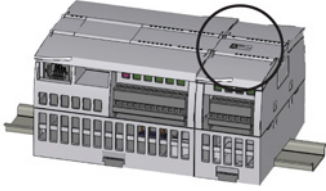
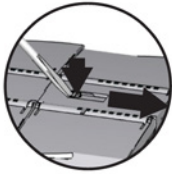
Table 3- 8 Installing a CM or CP



| Task | Procedure |
|--|--|
|  | <ol style="list-style-type: none"> 1. Ensure that the CPU and all S7-1200 equipment are disconnected from electrical power. 2. Attach the CM to the CPU before installing the assembly as a unit to the DIN rail or panel. 3. Remove the bus cover from the left side of the CPU: <ul style="list-style-type: none"> – Insert a screwdriver into the slot above the bus cover. – Gently pry out the cover at its top. 4. Remove the bus cover. Retain the cover for reuse. 5. Connect the CM or CP to the CPU: <ul style="list-style-type: none"> – Align the bus connector and the posts of the CM with the holes of the CPU – Firmly press the units together until the posts snap into place. 6. Install the CPU and CP on a DIN rail or panel. |
|  | |

Table 3- 9 Removing a CM or CP

| Task | Procedure |
|---|---|
|  | <p>Remove the CPU and CM as a unit from the DIN rail or panel.</p> <ol style="list-style-type: none"> 1. Ensure that the CPU and all S7-1200 equipment are disconnected from electrical power. 2. Remove the I/O connectors and all wiring and cables from the CPU and CMs. 3. For DIN rail mounting, move the lower DIN rail clips on the CPU and CMs to the extended position. 4. Remove the CPU and CMs from the DIN rail or panel. 5. Grasp the CPU and CMs firmly and pull apart. |
|  | |

| |
|--|
| NOTICE |
| Separate modules without using a tool. |
| Do not use a tool to separate the modules because this can damage the units. |

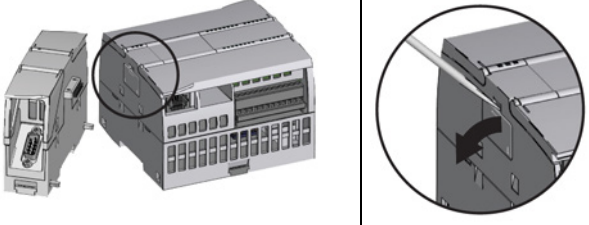
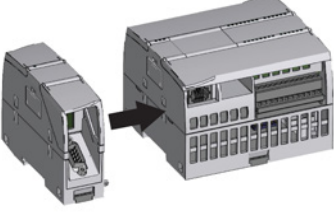
3.3.6 Removing and reinstalling the S7-1200 terminal block connector

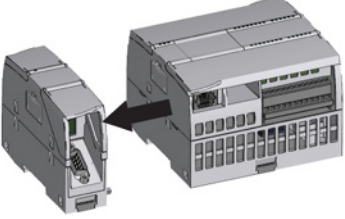
The CPU, SB and SM modules provide removable connectors to make connecting the wiring easy.

Table 3- 10 Removing the connector

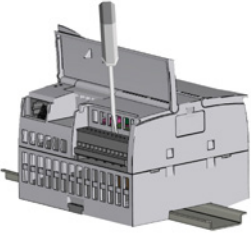
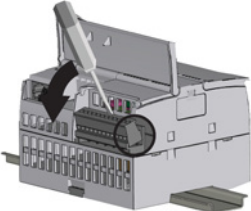
| Task | Procedure |
|---|---|
|  | <p>Prepare the system for terminal block connector removal by removing the power from the CPU and opening the cover above the connector.</p> <ol style="list-style-type: none"> 1. Ensure that the CPU and all S7-1200 equipment are disconnected from electrical power. 2. Inspect the top of the connector and locate the slot for the tip of the screwdriver. 3. Insert a screwdriver into the slot. 4. Gently pry the top of the connector away from the CPU. The connector will release with a snap. |
|  | <ol style="list-style-type: none"> 5. Grasp the connector and remove it from the CPU. |

3.3 Installation and removal procedures

Table 3- 11 Installing the connector

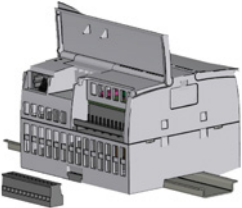
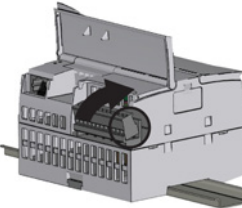
| Task | Procedure |
|---|--|
|  | <p>Prepare the components for terminal block installation by removing power from the CPU and opening the cover for connector.</p> <ol style="list-style-type: none"> 1. Ensure that the CPU and all S7-1200 equipment are disconnected from electrical power. 2. Align the connector with the pins on the unit. 3. Align the wiring edge of the connector inside the rim of the connector base. 4. Press firmly down and rotate the connector until it snaps into place. |
|  | <p>Check carefully to ensure that the connector is properly aligned and fully engaged.</p> |

3.3.7 Installing and removing the expansion cable

The S7-1200 expansion cable provides additional flexibility in configuring the layout of your S7-1200 system. Only one expansion cable is allowed per CPU system. You install the expansion cable either between the CPU and the first SM, or between any two SMs.

Table 3- 12 Installing and removing the male connector of the expansion cable

| Task | Procedure |
|---|--|
|  | <p>To install the male connector:</p> <ol style="list-style-type: none"> 1. Ensure that the CPU and all S7-1200 equipment are disconnected from electrical power. 2. Push the connector into the bus connector on the right side of the signal module or CPU. <p>To remove the male connector:</p> <ol style="list-style-type: none"> 1. Ensure that the CPU and all S7-1200 equipment are disconnected from electrical power. 2. Pull out the male connector to release it from the signal module or CPU. |
|  | |

Table 3- 13 Installing the female connector of the expansion cable

| Task | Procedure |
|---|---|
|  | <ol style="list-style-type: none"> 1. Ensure that the CPU and all S7-1200 equipment are disconnected from electrical power. 2. Place the female connector to the bus connector on the left side of the signal module. 3. Slip the hook extension of the female connector into the housing at the bus connector and press down slightly to engage the hook. 4. Lock the connector into place: <ul style="list-style-type: none"> - Place a screwdriver beside the tab on the top of the signal module. - Slide the tab fully to the left. |
|  | <p>To engage the connector, you must slide the connector tab all the way to the left. The connector tab must be locked into place.</p> |

Table 3- 14 Removing the female connector of the expansion cable

| Task | Procedure |
|---|---|
|  | <ol style="list-style-type: none"> 1. Ensure that the CPU and all S7-1200 equipment are disconnected from electrical power. 2. Unlock the connector: <ul style="list-style-type: none"> - Place a screwdriver beside the tab on the top of the signal module. - Press down slightly and slide the tab fully to the right. 3. Lift the connector up slightly to disengage the hook extension. 4. Remove the female connector. |
|  | |

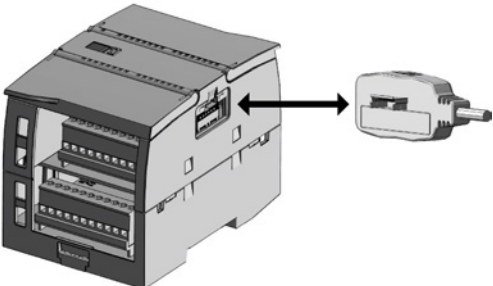
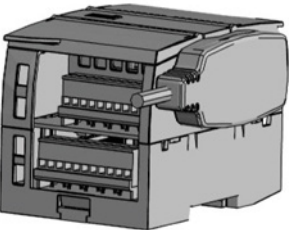
Note

Installing the expansion cable in a vibration environment

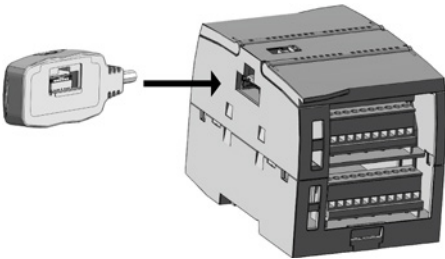
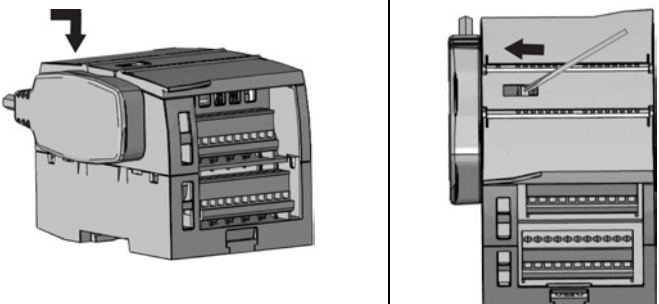
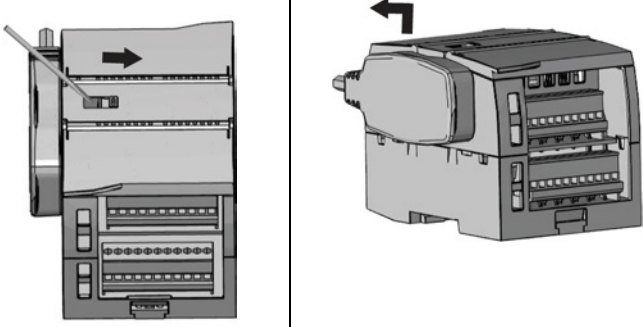
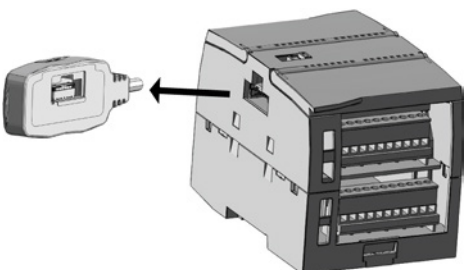
If the expansion cable is connected to modules that move, or are not firmly fixed, the cable male end snap-on connection can gradually become loose.

Use a cable tie to fix the male end cable on the DIN-rail (or other place) to provide extra strain relief.

Avoid using excessive force when you pull the cable during installation. Ensure the cable-module connection is in the correct position once installation is complete.

3.3.8 TS (TeleService) adapter

3.3.8.1 Connecting the TeleService adapter

Before installing the TS (TeleService) Adapter IE Basic, you must first connect the TS Adapter and a TS module.

Available TS modules:

- TS module RS232
- TS module Modem
- TS module GSM
- TS module ISDN

Note

The TS module can be damaged if you touch the contacts of the plug connector ④ of the TS module.

Follow ESD guidelines in order to avoid damaging the TS module through electrostatic discharge. Before connecting a TS module and TS Adapter, make sure that both are in an idle state.

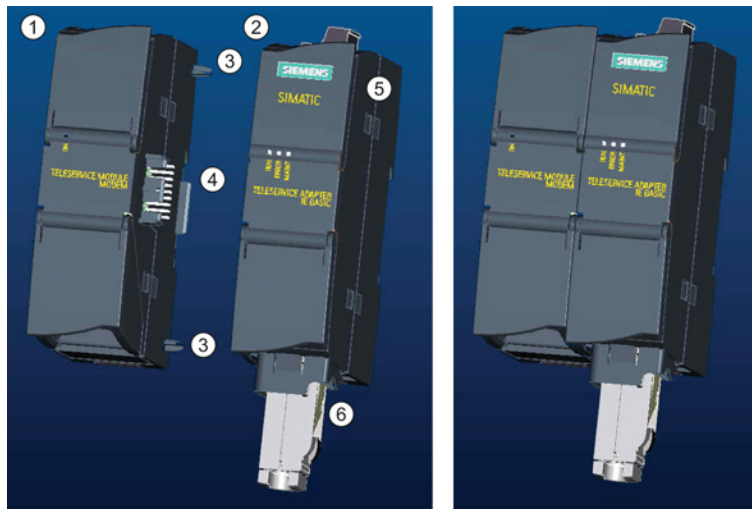

- | | | | |
|---|------------|---|-----------------------------------|
| ① | TS module | ④ | Plug connector from the TS module |
| ② | TS Adapter | ⑤ | Cannot be opened |
| ③ | Elements | ⑥ | Ethernet port |

Note

Before connecting a TS module and TS adapter basic unit, ensure that the contact pins ④ are not bent.

When connecting, ensure that the male connector and guide elements are positioned correctly.

Only connect a TS module into the TS adapter. Do not force a connection of the TS adapter to a different device, such as an S7-1200 CPU. Do not change the mechanical construction of the connector, and do not remove or damage the guide elements.

3.3.8.2 Installing the SIM card

Locate the SIM card slot on the underside of the TS module GSM.

Note

The SIM card may only be removed or inserted if the TS module GSM is de-energized.

3.3 Installation and removal procedures

Table 3- 15 Installing the SIM card

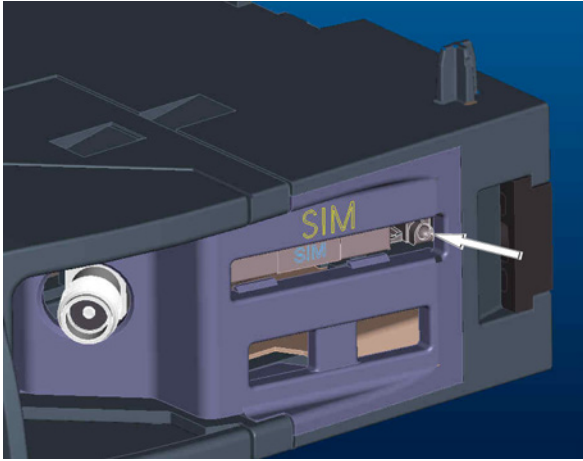
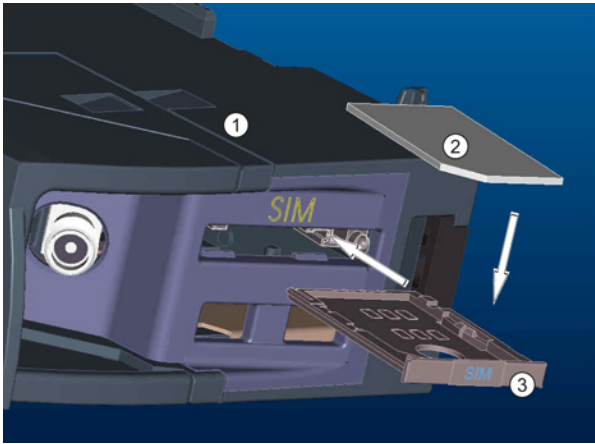
| Procedure | Task | | | | | | |
|--|--|---|---------------|---|----------|---|---------------|
| <p>Use a sharp object to press the eject button of the SIM card tray (in the direction of the arrow) and remove the SIM card tray.</p> |  | | | | | | |
| <p>Place the SIM card in the SIM card tray as shown and put the SIM card tray back into its slot.</p> |  <table border="1" data-bbox="1107 882 1439 1346"> <tr> <td data-bbox="1107 882 1182 922">①</td> <td data-bbox="1187 882 1439 922">TS Module GSM</td> </tr> <tr> <td data-bbox="1107 929 1182 969">②</td> <td data-bbox="1187 929 1439 969">SIM card</td> </tr> <tr> <td data-bbox="1107 976 1182 1346">③</td> <td data-bbox="1187 976 1439 1346">SIM card tray</td> </tr> </table> | ① | TS Module GSM | ② | SIM card | ③ | SIM card tray |
| ① | TS Module GSM | | | | | | |
| ② | SIM card | | | | | | |
| ③ | SIM card tray | | | | | | |

Note

Ensure that the SIM card tray is correctly oriented in the card tray. Otherwise, the SIM card will not make connection with the module, and the eject button may not remove the card tray.

3.3.8.3 Installing the TS adapter unit on a DIN rail

Prerequisites: You must have connected the TS Adapter and a TS module together, and the DIN rail must have been installed.

Note

If you install the TS unit vertically or in high-vibration environment, the TS module can become disconnected from the TS Adapter. Use an end bracket 8WA1 808 on the DIN rail to ensure that the modules remain connected.

Table 3- 16 Installing and removing the TS Adapter

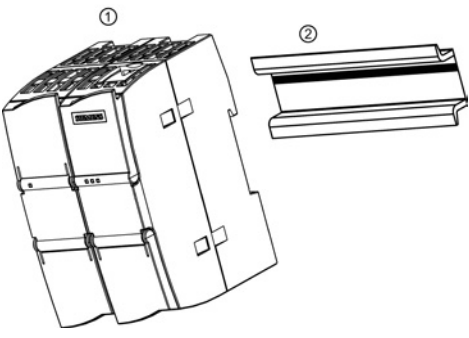
| Task | Procedure |
|--|---|
|  | <p>Installation:</p> <ol style="list-style-type: none"> Hook the TS Adapter with attached TS module ① on the DIN rail ②. Rotate the unit back until it engages. Push in the DIN rail clip on each module to attach each module to the rail. <p>Removal:</p> <ol style="list-style-type: none"> Remove the analog cable and Ethernet cable from the underside of the TS Adapter. Remove power from the TS Adapter. Use a screwdriver to disengage the rail clips on both modules. Rotate the unit upwards to remove the unit from the DIN rail. |

WARNING

Safety requirements for installing or removing the TS Adapter.

Before you remove power from the unit, disconnect the grounding of the TS Adapter by removing the analog cable and Ethernet cable. Failure to observe this precaution could result in death, severe personal injury and/or property damage due to unexpected equipment operation.

Always follow these requirements when installing or removing the TS Adapter.

3.3.8.4 Installing the TS adapter on a panel

Prerequisites: You must have connected the TS Adapter and TS module.

- Move the attachment slider ① to the backside of the TS Adapter and TS module in the direction of the arrow until it engages.
- Screw the TS Adapter and TS module to the position marked with ② to the designated assembly wall.

3.4 Wiring guidelines

The following illustration shows the TS Adapter from behind, with the attachment sliders ① in both positions:

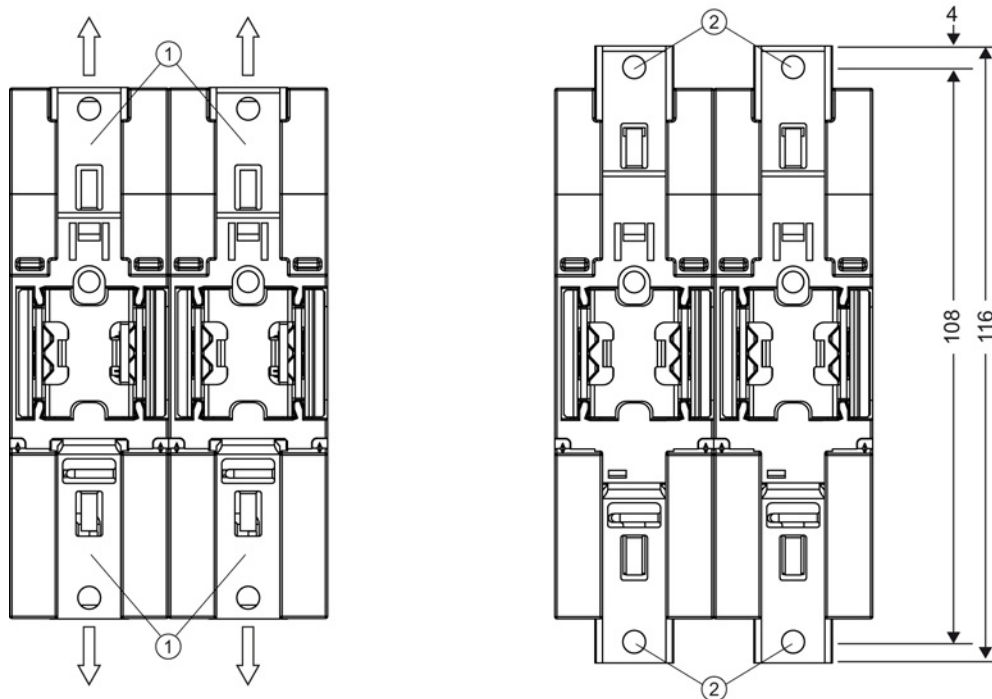

- ① Attachment slider
- ② Drill holes for wall mounting

3.4 Wiring guidelines

Proper grounding and wiring of all electrical equipment is important to help ensure the optimum operation of your system and to provide additional electrical noise protection for your application and the S7-1200. Refer to the technical specifications (Page 829) for the S7-1200 wiring diagrams.

Prerequisites

Before you ground or install wiring to any electrical device, ensure that the power to that equipment has been turned off. Also, ensure that the power to any related equipment has been turned off.

Ensure that you follow all applicable electrical codes when wiring the S7-1200 and related equipment. Install and operate all equipment according to all applicable national and local standards. Contact your local authorities to determine which codes and standards apply to your specific case.

 WARNING

Installation or wiring the S7-1200 or related equipment with power applied could cause electric shock or unexpected operation of equipment.

Failure to disable all power to the S7-1200 and related equipment during installation or removal procedures could result in death, severe personal injury, and/or damage due to electric shock or unexpected equipment operation.

Always follow appropriate safety precautions and ensure that power to the S7-1200 is disabled before attempting to install or remove the S7-1200 or related equipment.

Always take safety into consideration as you design the grounding and wiring of your S7-1200 system. Electronic control devices, such as the S7-1200, can fail and can cause unexpected operation of the equipment that is being controlled or monitored. For this reason, you should implement safeguards that are independent of the S7-1200 to protect against possible personal injury or equipment damage.

 WARNING

Control devices can fail in an unsafe condition, resulting in unexpected operation of controlled equipment.

Such unexpected operations could result in death, severe personal injury and/or property damage.

Use an emergency stop function, electromechanical overrides, or other redundant safeguards that are independent of the S7-1200.

Guidelines for isolation

S7-1200 AC power supply boundaries and I/O boundaries to AC circuits have been designed and approved to provide safe separation between AC line voltages and low voltage circuits. These boundaries include double or reinforced insulation, or basic plus supplementary insulation, according to various standards. Components which cross these boundaries such as optical couplers, capacitors, transformers, and relays have been approved as providing safe separation. Isolation boundaries which meet these requirements have been identified in S7-1200 product data sheets as having 1500 VAC or greater isolation. This designation is based on a routine factory test of $(2U_e + 1000 \text{ VAC})$ or equivalent according to approved methods. S7-1200 safe separation boundaries have been type tested to 4242 VDC.

The sensor supply output, communications circuits, and internal logic circuits of an S7-1200 with included AC power supply are sourced as SELV (safety extra-low voltage) according to EN 61131-2.

3.4 Wiring guidelines

To maintain the safe character of the S7-1200 low voltage circuits, external connections to communications ports, analog circuits, and all 24 VDC nominal power supply and I/O circuits must be powered from approved sources that meet the requirements of SELV, PELV, Class 2, Limited Voltage, or Limited Power according to various standards.

 **WARNING**

Use of non-isolated or single insulation supplies to supply low voltage circuits from an AC line can result in hazardous voltages appearing on circuits that are expected to be touch safe, such as communications circuits and low voltage sensor wiring.

Such unexpected high voltages could cause electric shock resulting in death, severe personal injury and/or property damage.

Only use high voltage to low voltage power converters that are approved as sources of touch safe, limited voltage circuits.

Guidelines for grounding the S7-1200

The best way to ground your application is to ensure that all the common and ground connections of your S7-1200 and related equipment are grounded to a single point. This single point should be connected directly to the earth ground for your system.

All ground wires should be as short as possible and should use a large wire size, such as 2 mm² (14 AWG).

When locating grounds, consider safety-grounding requirements and the proper operation of protective interrupting devices.

Guidelines for wiring the S7-1200

When designing the wiring for your S7-1200, provide a single disconnect switch that simultaneously removes power from the S7-1200 CPU power supply, from all input circuits, and from all output circuits. Provide over-current protection, such as a fuse or circuit breaker, to limit fault currents on supply wiring. Consider providing additional protection by placing a fuse or other current limit in each output circuit.

Install appropriate surge suppression devices for any wiring that could be subject to lightning surges.

Avoid placing low-voltage signal wires and communications cables in the same wire tray with AC wires and high-energy, rapidly switched DC wires. Always route wires in pairs, with the neutral or common wire paired with the hot or signal-carrying wire.

Use the shortest wire possible and ensure that the wire is sized properly to carry the required current. The CPU and SM connector accepts wire sizes from 2 mm² to 0.3 mm² (14 AWG to 22 AWG). The SB connector accepts wire sizes from 1.3 mm² to 0.3 mm² (16 AWG to 22 AWG). Use shielded wires for optimum protection against electrical noise. Typically, grounding the shield at the S7-1200 gives the best results.

When wiring input circuits that are powered by an external power supply, include an overcurrent protection device in that circuit. External protection is not necessary for circuits that are powered by the 24 VDC sensor supply from the S7-1200 because the sensor supply is already current-limited.

All S7-1200 modules have removable connectors for user wiring. To prevent loose connections, ensure that the connector is seated securely and that the wire is installed securely into the connector. To avoid damaging the connector, be careful that you do not over-tighten the screws. The maximum torque for the CPU and SM connector screw is 0.56 N-m (5 inch-pounds). The maximum torque for the SB, simulator, and potentiometer module connector screw is 0.33 N-m (3 inch-pounds).

To help prevent unwanted current flows in your installation, the S7-1200 provides isolation boundaries at certain points. When you plan the wiring for your system, you should consider these isolation boundaries. Refer to the technical specifications (Page 829) for the amount of isolation provided and the location of the isolation boundaries. Do not depend on isolation boundaries rated less than 1500 VAC as safety boundaries.

Guidelines for lamp loads

Lamp loads are damaging to relay contacts because of the high turn-on surge current. This surge current will nominally be 10 to 15 times the steady state current for a Tungsten lamp. A replaceable interposing relay or surge limiter is recommended for lamp loads that will be switched a large number of times during the lifetime of the application.

Guidelines for inductive loads

Use suppressor circuits with inductive loads to limit the voltage rise when a control output turns off. Suppressor circuits protect your outputs from premature failure caused by the high voltage transient that occurs when current flow through an inductive load is interrupted.

In addition, suppressor circuits limit the electrical noise generated when switching inductive loads. High frequency noise from poorly suppressed inductive loads can disrupt the operation of the PLC. Placing an external suppressor circuit so that it is electrically across the load and physically located near the load is the most effective way to reduce electrical noise.

S7-1200 DC outputs include internal suppressor circuits that are adequate for inductive loads in most applications. Since S7-1200 relay output contacts can be used to switch either a DC or an AC load, internal protection is not provided.

A good suppressor solution is to use contactors and other inductive loads for which the manufacturer provides suppressor circuits integrated in the load device, or as an optional accessory. However, some manufacturer provided suppressor circuits may be inadequate for your application. An additional suppressor circuit may be necessary for optimal noise reduction and contact life.

For AC loads, a metal oxide varistor (MOV) or other voltage clamping device may be used with a parallel RC circuit, but is not as effective when used alone. An MOV suppressor with no parallel RC circuit often results in significant high frequency noise up to the clamp voltage.

3.4 Wiring guidelines

A well controlled turn-off transient will have a ring frequency of no more than 10 kHz, with less than 1 kHz preferred. Peak voltage for AC lines should be within +/- 1200 V of ground. Negative peak voltage for DC loads using the PLC internal suppression will be ~40 V below the 24 VDC supply voltage. External suppression should limit the transient to within 36 V of the supply to unload the internal suppression.

Note

The effectiveness of a suppressor circuit depends on the application and must be verified for your particular usage. Ensure that all components are correctly rated and use an oscilloscope to observe the turn-off transient.

Typical suppressor circuit for DC or relay outputs that switch DC inductive loads

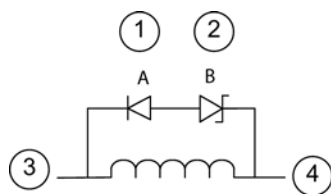

- ① 1N4001 diode or equivalent
- ② 8.2 V Zener (DC outputs),
36 V Zener (Relay outputs)
- ③ Output point
- ④ M, 24 V reference

In most applications, the addition of a diode (A) across a DC inductive load is suitable, but if your application requires faster turn-off times, then the addition of a zener diode (B) is recommended. Be sure to size your zener diode properly for the amount of current in your output circuit.

Typical suppressor circuit for relay outputs that switch AC inductive loads

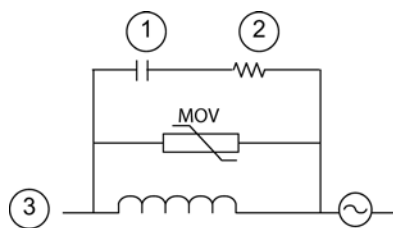

- ① See table for C value
- ② See table for R value
- ③ Output point

Ensure that the working voltage of the metal oxide varistor (MOV) is at least 20% greater than the nominal line voltage.

Choose pulse-rated, non-inductive resistors, and capacitors recommended for pulse applications (typically metal film). Verify the components meet average power, peak power, and peak voltage requirements.

If you design your own suppressor circuit, the following table suggests resistor and capacitor values for a range of AC loads. These values are based on calculations with ideal component parameters. I rms in the table refers to the steady-state current of the load when fully ON.

Table 3- 17 AC suppressor circuit resistor and capacitor values

| Inductive load | | | Suppressor values | | |
|----------------|---------|---------|-------------------|------------------|-----------|
| I rms | 230 VAC | 120 VAC | Resistor | | Capacitor |
| Amps | VA | VA | Ω | W (power rating) | nF |
| 0.02 | 4.6 | 2.4 | 15000 | 0.1 | 15 |
| 0.05 | 11.5 | 6 | 5600 | 0.25 | 470 |
| 0.1 | 23 | 12 | 2700 | 0.5 | 100 |
| 0.2 | 46 | 24 | 1500 | 1 | 150 |
| 0.05 | 115 | 60 | 560 | 2.5 | 470 |
| 1 | 230 | 120 | 270 | 5 | 1000 |
| 2 | 460 | 240 | 150 | 10 | 1500 |

Conditions satisfied by the table values:

- Maximum turn-off transition step < 500 V
- Resistor peak voltage < 500 V
- Capacitor peak voltage < 1250 V
- Suppressor current < 8% of load current (50 Hz)
- Suppressor current < 11% of load current (60 Hz)
- Capacitor $dV/dt < 2 \text{ V}/\mu\text{s}$
- Capacitor pulse dissipation : $\int (dv/dt)^2 dt < 10000 \text{ V}^2/\mu\text{s}$
- Resonant frequency < 300 Hz
- Resistor power for 2 Hz max switching frequency
- Power factor of 0.3 assumed for typical inductive load

Guidelines for differential inputs and outputs

Differential inputs and outputs behave differently than standard inputs and outputs. There are two pins per differential input and output. Determining whether a differential input or output is on or off requires that you measure the voltage difference between these two pins.

See the detailed specifications for the CPU 1217C in Appendix A (Page 879).

PLC concepts

4.1 Execution of the user program

The CPU supports the following types of code blocks that allow you to create an efficient structure for your user program:

- Organization blocks (OBs) define the structure of the program. Some OBs have predefined behavior and start events, but you can also create OBs with custom start events.
- Functions (FCs) and function blocks (FBs) contain the program code that corresponds to specific tasks or combinations of parameters. Each FC or FB provides a set of input and output parameters for sharing data with the calling block. An FB also uses an associated data block (called an instance DB) to maintain the data values for that instance of the FB call. You can call an FB multiple times, each time with a unique instance DB. Calls to the same FB with different instance DBs do not affect the data values in any of the other instance DBs.
- Data blocks (DBs) store data that can be used by the program blocks.

Execution of the user program begins with one or more optional startup organization blocks (OBs) which execute once upon entering RUN mode, followed by one or more program cycle OBs that execute cyclically. You can also associate an OB with an interrupt event, which can be either a standard event or an error event. These OBs execute whenever the corresponding standard or error event occurs.

A function (FC) or a function block (FB) is a block of program code that can be called from an OB or from another FC or FB, down to the following nesting depths:

- 16 from the program cycle or startup OB
- 6 from any interrupt event OB

FCs are not associated with any particular data block (DB). FBs are tied directly to a DB and use the DB for passing parameters and storing interim values and results.

The size of the user program, data, and configuration is limited by the available load memory and work memory in the CPU. There is no specific limit to the number of each individual OB, FC, FB and DB block. However, the total number of blocks is limited to 1024.

Each cycle includes writing the outputs, reading the inputs, executing the user program instructions, and performing background processing. The cycle is referred to as a scan cycle or scan.

4.1 Execution of the user program

Your S7-1200 automation solution can consist of a central rack with the S7-1200 CPU and additional modules. The term "central rack" refers to either the rail or panel installation of the CPU and associated modules. The modules (SM, SB, BB, CB, CM or CP) are detected and logged in only upon powerup.

- Inserting or removing a module in the central rack under power (hot) is not supported. Never insert or remove a module from the central rack when the CPU has power.

| |
|---|
|  WARNING |
| Safety requirements for inserting or removing modules Insertion or removal of a module (SM, SB, BB, CD, CM or CP) from the central rack when the CPU has power could cause unpredictable behavior, resulting in damage to equipment and/or injury to personnel. Always remove power from the CPU and central rack and follow appropriate safety precautions before inserting or removing a module from the central rack. |

- You can insert or remove a SIMATIC memory card while the CPU is under power. However, inserting or removing a memory card when the CPU is in RUN mode causes the CPU to go to STOP mode.

| |
|---|
| NOTICE |
| Risks with removing memory card when CPU is in RUN mode. Insertion or removal of a memory card when the CPU is in RUN mode causes the CPU to go to STOP, which might result in damage to the equipment or the process being controlled. Whenever you insert or remove a memory card, the CPU immediately goes to STOP mode. Before inserting or removing a memory card, always ensure that the CPU is not actively controlling a machine or process. Always install an emergency stop circuit for your application or process. |

- If you insert or remove a module in a distributed I/O rack (AS-i, PROFINET, or PROFIBUS) when the CPU is in RUN mode, the CPU generates an entry in the diagnostics buffer, executes the pull or plug of modules OB if present, and by default remains in RUN mode.

Process image update and process image partitions

The CPU updates local digital and analog I/O points synchronously with the scan cycle using an internal memory area called the process image. The process image contains a snapshot of the physical inputs and outputs (the physical I/O points on the CPU, signal board, and signal modules).

You can configure I/O points to be updated in the process image every scan cycle or when a specific event interrupt occurs. You can also configure an I/O point to be excluded from process image updates. For example, your process might only need certain data values when an event such as a hardware interrupt occurs. By configuring the process image update for these I/O points to be associated with a partition that you assign to a hardware interrupt OB, you avoid having the CPU update data values unnecessarily every scan cycle when your process does not need a continual update.

For I/O that is updated every scan cycle, the CPU performs the following tasks during each scan cycle:

- The CPU writes the outputs from the process image output area to the physical outputs.
- The CPU reads the physical inputs just prior to the execution of the user program and stores the input values in the process image input area. These values thus remain consistent throughout the execution of the user instructions.
- The CPU executes the logic of the user instructions and updates the output values in the process image output area instead of writing to the actual physical outputs.

This process provides consistent logic through the execution of the user instructions for a given cycle and prevents the flickering of physical output points that might change state multiple times in the process image output area.

For controlling whether your process updates I/O points automatically on every scan cycle, or upon the triggering of events, the S7-1200 provides five process image partitions. The first process image partition, PIP0, is designated for I/O that is to be automatically updated every scan cycle, and is the default assignment. You can use the remaining four partitions, PIP1, PIP2, PIP3, and PIP4 for assigning I/O process image updates to various interrupt events. You assign I/O to process image partitions in Device Configuration and you assign process image partitions to interrupt events when you create interrupt OBs (Page 172) or edit OB properties (Page 172).

By default, when you insert a module in the device view, STEP 7 sets its I/O process image update to "Automatic update". For I/O configured for "Automatic update", the CPU handles the data exchange between the module and the process image area automatically during every scan cycle.

To assign digital or analog points to a process image partition, or to exclude I/O points from process image updates, follow these steps:

1. View the Properties tab for the appropriate device in Device configuration.
2. Expand the selections under "General" as necessary to locate the desired I/O points.
3. Select "I/O addresses".

4.1 Execution of the user program

- 4. Optionally select a specific OB from the "Organization block" drop-down list.
- 5. From the "Process image" drop-down list, change "Automatic update" to "PIP1", "PIP2", "PIP3", "PIP4" or "None". A selection of "None" means that you can only read from and write to this I/O using immediate instructions. To add the points back to the process image automatic update, change this selection back to "Automatic update".

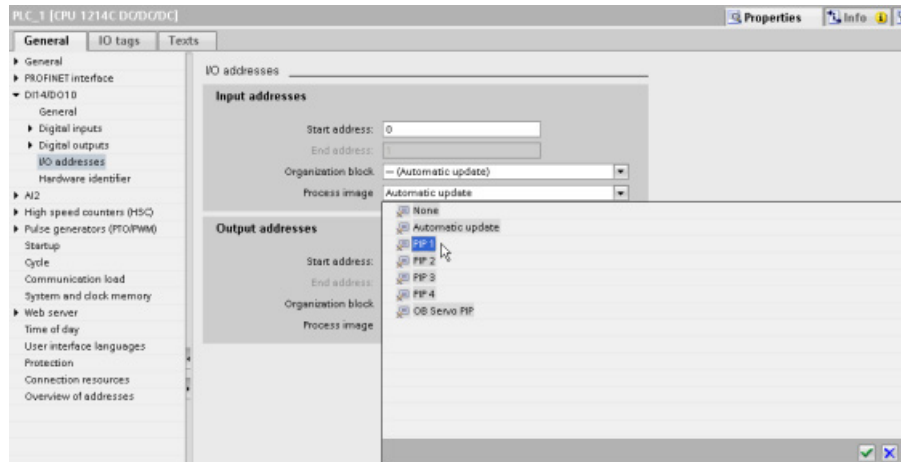

You can immediately read physical input values and immediately write physical output values when an instruction executes. An immediate read accesses the current state of the physical input and does not update the process image input area, regardless of whether the point is configured to be stored in the process image. An immediate write to the physical output updates both the process image output area (if the point is configured to be stored in the process image) and the physical output point. Append the suffix ":P" to the I/O address if you want the program to immediately access I/O data directly from the physical point instead of using the process image.

Note

Use of process image partitions

If you assign I/O to one of the process image partitions PIP1 - PIP4, and do not assign an OB to that partition, then the CPU never updates that I/O to or from the process image. Assigning I/O to a PIP that does not have a corresponding OB assignment, is the same as assigning the process image to "None". You can read the I/O directly from the physical I/O with an immediate read instruction, or write to the physical I/O with an immediate write instruction. The CPU does not update the process image.

The CPU supports distributed I/O for both PROFINET and PROFIBUS networks (Page 509).

4.1.1 Operating modes of the CPU

The CPU has three modes of operation: STOP mode, STARTUP mode, and RUN mode. Status LEDs on the front of the CPU indicate the current mode of operation.

- In STOP mode, the CPU is not executing the program. You can download a project.
- In STARTUP mode, the startup OBs (if present) execute once. The CPU does not process interrupt events during the startup mode.
- In RUN mode, the program cycle OBs execute repeatedly. Interrupt events can occur and the corresponding interrupt event OBs can execute at any point within the RUN mode. You can download some parts of a project in RUN mode (Page 803).

The CPU supports a warm restart for entering the RUN mode. Warm restart does not include a memory reset. The CPU initializes all non-retentive system and user data at warm restart, and retains the values of all retentive user data.

A memory reset clears all work memory, clears retentive and non-retentive memory areas, copies load memory to work memory, and sets outputs to the configured "Reaction to CPU STOP". A memory reset does not clear the diagnostics buffer or the permanently saved values of the IP address.

You can configure the "startup after POWER ON" setting of the CPU. This configuration item appears under the "Device configuration" for the CPU under "Startup". Upon powering up, the CPU performs a sequence of power-up diagnostic checks and system initialization. During system initialization the CPU deletes all non-retentive bit (M) memory and resets all non-retentive DB contents to the initial values from load memory. The CPU retains retentive bit (M) memory and retentive DB contents and then enters the appropriate operating mode. Certain detected errors prevent the CPU from entering the RUN mode. The CPU supports the following configuration choices:

- No restart (stay in STOP mode)
- Warm restart - RUN
- Warm restart - mode prior to POWER OFF

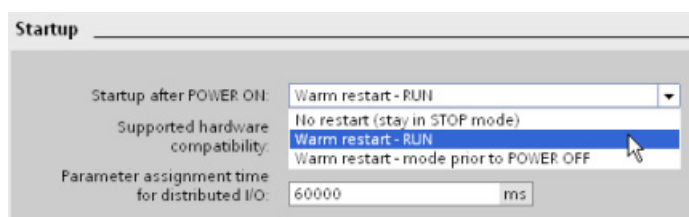

| |
|--|
| NOTICE |
| Repairable faults can cause the CPU to enter STOP mode. |
| The CPU can enter STOP mode due to repairable faults, such as failure of a replaceable signal module, or temporary faults, such as power line disturbance or erratic power up event. Such conditions could result in property damage. |
| If you have configured the CPU to "Warm restart - mode prior to POWER OFF", the CPU goes to the operating mode it was in prior to the loss of power or fault. If the CPU was in STOP mode at the time of power loss or fault, the CPU goes to STOP mode on power up and stays in STOP mode until it receives a command to go to RUN mode. If the CPU was in RUN mode at the time of power loss or fault, the CPU goes to RUN mode on the next power up providing it detects no errors that would inhibit a transition to RUN mode. |
| Configure CPUs that are intended to operate independently of a STEP 7 connection to "Warm restart - RUN" so that the CPU can return to RUN mode on the next power cycle. |

You can change the current operating mode using the "STOP" or "RUN" commands (Page 792) from the online tools of the programming software. You can also include a STP instruction (Page 263) in your program to change the CPU to STOP mode. This allows you to stop the execution of your program based on the program logic.

- In STOP mode, the CPU handles any communication requests (as appropriate) and performs self-diagnostics. The CPU does not execute the user program, and the automatic updates of the process image do not occur.
- In STARTUP and RUN modes, the CPU performs the tasks shown in the following figure.

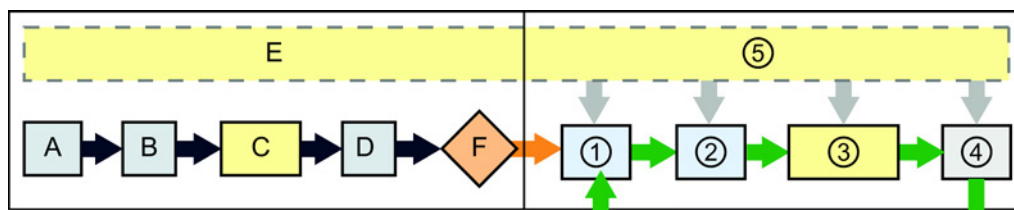

STARTUP

- A Clears the I (image) memory area
- B Initializes the Q output (image) memory area with either zero, the last value, or the substitute value, as configured, and zeroes PB, PN, and AS-i outputs
- C Initializes non-retentive M memory and data blocks to their initial value and enables configured cyclic interrupt and time of day events.
Executes the startup OBs.
- D Copies the state of the physical inputs to I memory
- E Stores any interrupt events into the queue to be processed after entering RUN mode
- F Enables the writing of Q memory to the physical outputs

RUN

- ① Writes Q memory to the physical outputs
- ② Copies the state of the physical inputs to I memory
- ③ Executes the program cycle OBs
- ④ Performs self-test diagnostics
- ⑤ Processes interrupts and communications during any part of the scan cycle

STARTUP processing

Whenever the operating mode changes from STOP to RUN, the CPU clears the process image inputs, initializes the process image outputs and processes the startup OBs. Any read accesses to the process-image inputs by instructions in the startup OBs read zero rather than the current physical input value. Therefore, to read the current state of a physical input during the startup mode, you must perform an immediate read. The startup OBs and any associated FCs and FBs are executed next. If more than one startup OB exists, each is executed in order according to the OB number, with the lowest OB number executing first.

Each startup OB includes startup information that helps you determine the validity of retentive data and the time-of-day clock. You can program instructions inside the startup OBs to examine these startup values and to take appropriate action. The following startup locations are supported by the Startup OBs:

Table 4- 1 Startup locations supported by the startup OB

| Input | Data Type | Description |
|---------------|-----------|---|
| LostRetentive | Bool | This bit is true if the retentive data storage areas have been lost |
| LostRTC | Bool | This bit is true if the time-of-day clock (Real time Clock) has been lost |

The CPU also performs the following tasks during the startup processing.

- Interrupts are queued but not processed during the startup phase
- No cycle time monitoring is performed during the startup phase
- Configuration changes to HSC (high-speed counter), PWM (pulse-width modulation), and PtP (point-to-point communication) modules can be made in startup
- Actual operation of HSC, PWM and point-to-point communication modules only occurs in RUN

After the execution of the startup OBs finishes, the CPU goes to RUN mode and processes the control tasks in a continuous scan cycle.

4.1.2 Processing the scan cycle in RUN mode

For each scan cycle, the CPU writes the outputs, reads the inputs, executes the user program, updates communication modules, and responds to user interrupt events and communication requests. Communication requests are handled periodically throughout the scan.

These actions (except for user interrupt events) are serviced regularly and in sequential order. User interrupt events that are enabled are serviced according to priority in the order in which they occur. For interrupt events, the CPU reads the inputs, executes the OB, and then writes the outputs, using the associated process image partition (PIP), if applicable.

The system guarantees that the scan cycle will be completed in a time period called the maximum cycle time; otherwise a time error event is generated.

- Each scan cycle begins by retrieving the current values of the digital and analog outputs from the process image and then writing them to the physical outputs of the CPU, SB, and SM modules configured for automatic I/O update (default configuration). When a physical output is accessed by an instruction, both the output process image and the physical output itself are updated.
- The scan cycle continues by reading the current values of the digital and analog inputs from the CPU, SB, and SMs configured for automatic I/O update (default configuration), and then writing these values to the process image. When a physical input is accessed by an instruction, the value of the physical input is accessed by the instruction, but the input process image is not updated.
- After reading the inputs, the user program is executed from the first instruction through the end instruction. This includes all the program cycle OBs plus all their associated FCs and FBs. The program cycle OBs are executed in order according to the OB number with the lowest OB number executing first.

Communications processing occurs periodically throughout the scan, possibly interrupting user program execution.

Self-diagnostic checks include periodic checks of the system and the I/O module status checks.

Interrupts can occur during any part of the scan cycle, and are event-driven. When an event occurs, the CPU interrupts the scan cycle and calls the OB that was configured to process that event. After the OB finishes processing the event, the CPU resumes execution of the user program at the point of interruption.

4.1.3 Organization blocks (OBs)

OBs control the execution of the user program. Specific events in the CPU trigger the execution of an organization block. OBs cannot call each other or be called from an FC or FB. Only an event such as a diagnostic interrupt or a time interval, can start the execution of an OB. The CPU handles OBs according to their respective priority classes, with higher priority OBs executing before lower priority OBs. The lowest priority class is 1 (for the main program cycle), and the highest priority class is 24.

4.1 Execution of the user program

4.1.3.1 Program cycle OB

Program cycle OBs execute cyclically while the CPU is in RUN mode. The main block of the program is a program cycle OB. This is where you place the instructions that control your program and where you call additional user blocks. You can have multiple program cycle OBs, which the CPU executes in numerical order. Main (OB1) is the default.

Program cycle events

The program cycle event happens once during each program cycle (or scan). During the program cycle, the CPU writes the outputs, reads the inputs and executes program cycle OBs. The program cycle event is required and is always enabled. You might have no program cycle OBs, or you might have multiple OBs selected for the program cycle event. After the program cycle event occurs, the CPU executes the lowest numbered program cycle OB (usually "Main" OB 1). The CPU executes the other program cycle OBs sequentially (in numerical order) within the program cycle. Program execution is cyclical such that the program cycle event occurs at the following times:

- When the last startup OB finishes execution
- When the last program cycle OB finishes execution

Table 4- 2 Start information for a program cycle OB

| Input | Data type | Description |
|--------------|-----------|--------------------------------------|
| Initial_Call | Bool | True for initial call of the OB |
| Remanence | Bool | True if retentive data are available |

4.1.3.2 Startup OB

Startup OBs execute one time when the operating mode of the CPU changes from STOP to RUN, including powering up in the RUN mode and in commanded STOP-to-RUN transitions. After completion, the main "Program cycle" begins executing.

Startup events

The startup event happens one time on a STOP to RUN transition and causes the CPU to execute the startup OBs. You can configure multiple OBs for the startup event. The startup OBs execute in numerical order.

Table 4- 3 Start information for a startup OB

| Input | Data type | Description |
|---------------|-----------|---------------------------------|
| LostRetentive | Bool | True if retentive data are lost |
| LostRTC | Bool | True if date and time are lost |

4.1.3.3 Time delay interrupt OB

Time delay interrupt OBs execute after a time delay that you configure.

Time delay interrupt events

You configure time delay interrupt events to occur after a specified delay time has expired. You assign the delay time with the SRT_DINT instruction. The time delay events interrupt the program cycle to execute the corresponding time delay interrupt OB. You can attach only one time delay interrupt OB to a time delay event. The CPU supports four time delay events.

Table 4- 4 Start information for a time delay interrupt OB

| Input | Data type | Description |
|-------|-----------|--|
| Sign | Word | Identifier passed to triggering call of SRT_DINT |

4.1.3.4 Cyclic interrupt OB

Cyclic interrupt OBs execute at a specified interval. You can configure up to a total of four cyclic interrupt events, with one OB corresponding to each cyclic interrupt event.

Cyclic interrupt events

The cyclic interrupt events allow you to configure the execution of an interrupt OB at a configured cycle time. You configure the initial cycle time when you create the cyclic interrupt OB. A cyclic event interrupts the program cycle and executes the corresponding cyclic interrupt OB. Note that the cyclic interrupt event is at a higher priority class than the program cycle event.

You can attach only one cyclic interrupt OB to a cyclic event.

You can assign a phase shift to each cyclic interrupt so that the execution of cyclic interrupts with the same scan time can be offset from one another by the phase offset amount. The default phase offset is 0. To change the initial phase shift, or to change the initial scan time for a cyclic event, right click the cyclic interrupt OB in the project tree, select "Properties" from the context menu, then click "Cyclic interrupt", and enter the new initial values. You can also query and change the scan time and the phase shift from your program using the Query cyclic interrupt (QRY_CINT) and Set cyclic interrupt (SET_CINT) instructions. Scan time and phase shift values set by the SET_CINT instruction do not persist through a power cycle or a transition to STOP mode; scan time and phase shift values return to the initial values following a power cycle or a transition to STOP. The CPU supports a total of four cyclic interrupt events.

4.1.3.5 Hardware interrupt OB

Hardware interrupt OBs execute when the relevant hardware event occurs. A hardware interrupt OB interrupts normal cyclic program execution in reaction to a signal from a hardware event.

Hardware interrupt events

Changes in the hardware, such as a rising or falling edge on an input point, or an HSC (High Speed Counter) event trigger hardware interrupt events. The S7-1200 supports one interrupt OB for each hardware interrupt event. You enable the hardware events in the device configuration, and assign an OB for an event in the device configuration or with an ATTACH instruction in the user program. The CPU supports several hardware interrupt events. The CPU model and the number of input points determine the exact events that are available.

Limits on hardware interrupt events are as follows:

Edges:

- Rising edge events: maximum of 16
- Falling edge events: maximum of 16

HSC events:

- CV=PV: maximum of 6
- Direction changed: maximum of 6
- External reset: maximum of 6

4.1.3.6 Time error interrupt OB

If configured, the time error interrupt OB (OB 80) executes when either the scan cycle exceeds the maximum cycle time or a time error event occurs. If triggered, it executes, interrupting normal cyclic program execution or any other event OB.

The occurrence of either of these events generates a diagnostic buffer entry describing the event. The diagnostic buffer entry is generated regardless of the existence of the time error interrupt OB.

Time error interrupt events

The occurrence of any of several different time error conditions results in a time error event:

- Scan cycle exceeds maximum cycle time

The "maximum cycle time exceeded" condition results if the program cycle does not complete within the specified maximum scan cycle time. See the section on "Monitoring the cycle time in the S7-1200 System Manual" (Page 97) for more information regarding the maximum cycle time condition, how to configure the maximum scan cycle time in the properties of the CPU, and how to reset the cycle timer.

- CPU cannot start requested OB because a second time interrupt (cyclic or time-delay) starts before the CPU finishes execution of the first interrupt OB
- Queue overflow occurred

The "queue overflow occurred" condition results if the interrupts are occurring faster than the CPU can process them. The CPU limits the number of pending (queued) events by using a different queue for each event type. If an event occurs when the corresponding queue is full, the CPU generates a time error event.

All time error events trigger the execution of the time error interrupt OB if it exists. If the time error interrupt OB does not exist, then the device configuration of the CPU determines the CPU reaction to the time error:

- The default configuration for time errors, such as starting a second cyclic interrupt before the CPU has finished the execution of the first, is for the CPU to stay in RUN.
- The default configuration for exceeding the maximum time is for the CPU to change to STOP.

The user program can extend the program cycle execution time up to ten times the configured maximum cycle time by executing the RE_TRIGR instruction (Page 262) to restart the cycle time monitor. However, if two "maximum cycle time exceeded" conditions occur within the same program cycle without resetting the cycle timer, then the CPU transitions to STOP, regardless of whether the time error interrupt OB exists. See the section on "Monitoring the cycle time in the S7-1200 System Manual" (Page 97).

Time error interrupt OB includes start information that helps you determine which event and OB generated the time error. You can program instructions inside the OB to examine these start values and to take appropriate action.

Table 4- 5 Start information for the time error OB (OB 80)

| Input | Data type | Description |
|----------|-----------|--|
| fault_id | BYTE | 16#01 - maximum cycle time exceeded 16#02 - requested OB cannot be started 16#07 and 16#09 - queue overflow occurred |
| csg_OBnr | OB_ANY | Number of the OB which was being executed when the error occurred |
| csg_prio | UINT | Priority of the OB causing the error |

To include a time error interrupt OB in your project, you must add a time error interrupt by double-clicking "Add new block" under "Program blocks" in the tree, then choose "Organization block", and then "Time error interrupt".

The priority for a new V4.0 CPU is 22. If you exchange a V3.0 CPU for a V4.0 CPU (Page 995), the priority is 26, the priority that was in effect for V3.0. In either case, the priority field is editable and you can set the priority to any value in the range 22 to 26.

4.1.3.7 Diagnostic error interrupt OB

The diagnostic error interrupt OB executes when the CPU detects a diagnostic error, or if a diagnostics-capable module recognizes an error and you have enabled the diagnostic error interrupt for the module. The diagnostic error interrupt OB interrupts the normal cyclic program execution. You can include an STP instruction in the diagnostic error interrupt OB to put the CPU in STOP mode if you desire your CPU to enter STOP mode upon receiving this type of error.

If you do not include a diagnostic error interrupt OB in your program, the CPU ignores the error and stays in RUN mode.

Diagnostic error events

Analog (local), PROFINET, PROFIBUS, and some digital (local) devices are capable of detecting and reporting diagnostic errors. The occurrence or removal of any of several different diagnostic error conditions results in a diagnostic error event. The following diagnostic errors are supported:

- No user power
- High limit exceeded
- Low limit exceeded
- Wire break
- Short circuit

Diagnostic error events trigger the execution of the diagnostic error interrupt OB (OB 82) if it exists. If it does not exist, then the CPU ignores the error.

To include a diagnostic error interrupt OB in your project, you must add a diagnostic error interrupt by double-clicking "Add new block" under "Program blocks" in the tree, then choose "Organization block", and then "Diagnostic error interrupt".

Note

Diagnostic errors for multi-channel local analog devices (I/O, RTD, and Thermocouple)

The diagnostic error interrupt OB can report only one channel's diagnostic error at a time.

If two channels of a multi-channel device have an error, then the second error only triggers the diagnostic error interrupt OB under the following conditions: the first channel error clears, the execution of the diagnostic error interrupt OB that the first error triggered is complete, and the second error still exists.

The diagnostic error interrupt OB includes startup information that helps you determine whether the event is due to the occurrence or removal of an error, and the device and channel which reported the error. You can program instructions inside the diagnostic error interrupt OB to examine these startup values and to take appropriate action.

Note

Diagnostic error OB Start information references the submodule as a whole if no diagnostics event is pending

In V3.0, the start information for an outgoing diagnostic error event always indicated the source of the event. In V4.0, if the outgoing event leaves the submodule with no pending diagnostics, the start information references the submodule as a whole (16#8000) even if the source of the event was a specific channel.

For example, if a wire break triggers a diagnostic error event on channel 2, the fault is then corrected, and the diagnostic error event is cleared, the Start information will not reference channel 2, but the submodule (16#8000).

Table 4- 6 Startup information for the diagnostic error interrupt OB

| Input | Data type | Description |
|------------|-----------|--|
| IOstate | WORD | IO state of the device: <ul style="list-style-type: none"> • Bit 0 = 1 if the configuration is correct, and = 0 if the configuration is no longer correct. • Bit 4 = 1 if an error is present (such as a wire break). (Bit 4 = 0 if there is no error.) • Bit 5 = 1 if the configuration is not correct, and = 0 if the configuration is correct again. • Bit 6 = 1 if an I/O access error has occurred. Refer to LADDR for the hardware identifier of the I/O with the access error. (Bit 6 = 0 if there is no error.) |
| LADDR | HW_ANY | Hardware identifier of the device or functional unit that reported the error ¹ |
| Channel | UINT | Channel number |
| MultiError | BOOL | TRUE if more than one error is present |

¹ The LADDR input contains the hardware identifier of the device or functional unit which returned the error. The hardware identifier is assigned automatically when components are inserted in the device or network view and appears in the Constants tab of PLC tags. A name is also assigned automatically for the hardware identifier. These entries in the Constants tab of the PLC tags cannot be changed.

4.1.3.8 Pull or plug of modules OB

The "Pull or plug of modules" OB executes when a configured and non-disabled distributed I/O module or submodule (PROFIBUS, PROFINET, AS-i) generates an event related to inserting or removing a module.

Pull or plug of modules event

The following conditions generate a pull or plug of modules event:

- Someone removes or inserts a configured module
- A configured module is not physically present in an expansion rack
- An incompatible module is in an expansion rack that does not correspond to the configured module
- A compatible module for a configured module is in an expansion rack, but the configuration does not allow substitutes
- A module or submodule has parameterization errors

If you have not programmed this OB, the CPU changes to STOP mode when any of these conditions occur.

4.1 Execution of the user program

Table 4- 7 Start information for pull or plug of modules OB

| Input | Data type | Description |
|-------------|-----------|---|
| LADDR | HW_IO | Hardware identifier |
| Event_Class | Byte | 16#38: module inserted 16#29: module removed |
| Fault_ID | Byte | Fault identifier |

4.1.3.9 Rack or station failure OB

The "Rack or station failure" OB executes when the CPU detects the failure or communication loss of a distributed rack or station.

Rack or station failure event

The CPU generates a rack or station failure event when it detects one of the following:

- The failure of a DP master system or of a PROFINET IO system (in the case of either an incoming or an outgoing event).
- The failure of a DP slave or of an IO device (in the case of either an incoming or an outgoing event)
- Failure of some of the submodules of a PROFINET I-device

If you have not programmed this OB, the CPU changes to STOP mode when any of these conditions occur.

Table 4- 8 Start information for rack or station failure OB

| Input | Data type | Description |
|-------------|-----------|--|
| LADDR | HW_IO | Hardware identifier |
| Event_Class | Byte | 16#32: Activation of a DP slave or an IO device 16#33: Deactivation of a DP slave or an IO device 16#38: outgoing event 16#39: incoming event |
| Fault_ID | Byte | Fault identifier |

4.1.3.10 Time of day OB

Time of day OBs execute based on configured clock time conditions. The CPU supports two time of day OBs.

Time of day events

You can configure a time of day interrupt event to occur once on a specified date or time or cyclically with one of the following cycles:

- Every minute: The interrupt occurs every minute.
- Hourly: The interrupt occurs every hour.
- Daily: The interrupt occurs every day at a specified time (hour and minute).
- Weekly: The interrupt occurs every week at a specified time on a specified day of the week (for example, every Tuesday at 4:30 in the afternoon).
- Monthly: The interrupt occurs every month at a specified time on a specified day of the month. The day number must be between 1 and 28, inclusive.
- Every end of month: The interrupt occurs on the last day of every month at a specified time.
- Yearly: The interrupt occurs every year on the specified date (month and day). You cannot specify a date of February 29.

Table 4- 9 Start information for a time of day event OB

| Input | Data type | Description |
|-------------|-----------|--|
| CaughtUp | Bool | OB call is caught up because time was set forward |
| SecondTimes | Bool | OB call is started a second time because time was set backward |

4.1.3.11 Status OB

Status OBs execute if a DPV1 or PNIO slave triggers a status interrupt. This might be the case if a component (module or rack) of a DPV1 or PNIO slave changes its operating mode, for example from RUN to STOP.

Status events

For detailed information on events that trigger a status interrupt, refer to the manufacturer's documentation for the DPV1 or PNIO slave.

Table 4- 10 Start information for status OB

| Input | Data type | Description |
|-----------|-----------|---------------------|
| LADDR | HW_IO | Hardware identifier |
| Slot | UInt | Slot number |
| Specifier | Word | Alarm specifier |

4.1.3.12 Update OB

Update OBs execute if a DPV1 or PNIO slave triggers an update interrupt.

Update events

For detailed information on events that trigger an update interrupt, refer to the manufacturer's documentation for the DPV1 or PNIO slave.

Table 4- 11 Start information for update OB

| Input | Data type | Description |
|-----------|-----------|---------------------|
| LADDR | HW_IO | Hardware identifier |
| Slot | UInt | Slot number |
| Specifier | Word | Alarm specifier |

4.1.3.13 Profile OB

Profile OBs execute if a DPV1 or PNIO slave triggers a profile-specific interrupt.

Profile events

For detailed information on events that trigger a profile interrupt, refer to the manufacturer's documentation for the DPV1 or PNIO slave.

Table 4- 12 Start information for profile OB

| Input | Data type | Description |
|-----------|-----------|---------------------|
| LADDR | HW_IO | Hardware identifier |
| Slot | UInt | Slot number |
| Specifier | Word | Alarm specifier |

4.1.3.14 Event execution priorities and queuing

The CPU processing is controlled by events. An event triggers an interrupt OB to be executed. You can specify the interrupt OB for an event during the creation of the block, during the device configuration, or with an ATTACH or DETACH instruction. Some events happen on a regular basis like the program cycle or cyclic events. Other events happen only a single time, like the startup event and time delay events. Some events happen when the hardware triggers an event, such as an edge event on an input point or a high speed counter event. Events like the diagnostic error and time error event only happen when an error occurs. The event priorities and queues are used to determine the processing order for the event interrupt OBs.

The CPU processes events in order of priority where 1 is the lowest priority and 26 is the highest priority. Prior to V4.0 of the S7-1200 CPU, each type of OB belonged to a fixed priority class (1 to 26). With V4.0, you can assign a priority class to each OB that you configure. You configure the priority number in the attributes of the OB properties.

Interruptible and non-interruptible execution modes

OBs (Page 85) execute in priority order of the events that trigger them. With V4.0 of the S7-1200 CPU, you can configure OB execution to be interruptible or non-interruptible. Note that program cycle OBs are always interruptible, but you can configure all other OBs to be either interruptible or non-interruptible.

If you set interruptible mode, then if an OB is executing and a higher priority event occurs before the OB completes its execution, the running OB is interrupted to allow the higher-priority event OB to run. The higher-priority event runs, and at its completion, the OB that was interrupted continues. When multiple events occur while an interruptible OB is executing, the CPU processes those events in priority order.

If you do not set interruptible mode, then an OB runs to completion when triggered regardless of any other events that trigger during the time that it is running.

Consider the following two cases where interrupt events trigger a cyclic OB and a time delay OB. In both cases, the time delay OB (OB201) has no process image partition assignment (Page 77) and executes at priority 4. The cyclic OB (OB200) has a process image partition assignment of PIP1 and executes at priority 2. The following illustrations show the difference in execution between non-interruptible and interruptible execution modes:

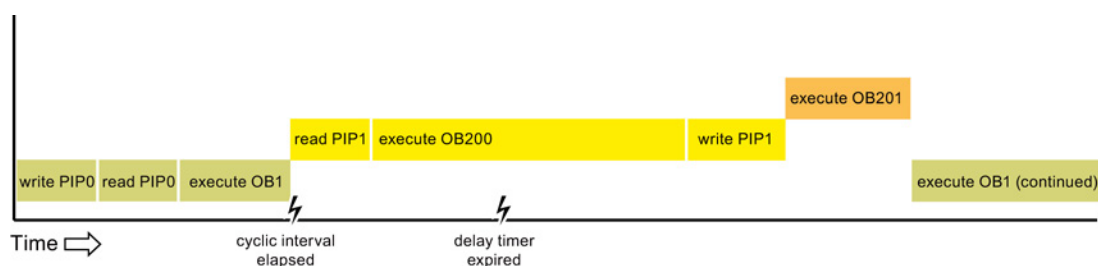

Figure 4-1 Case 1: Non-interruptible OB execution

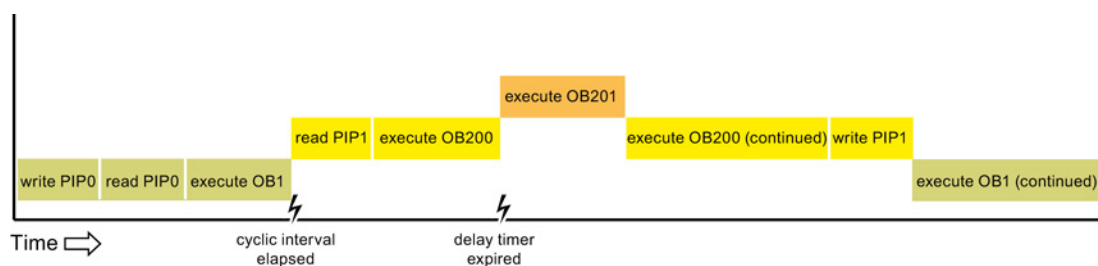

Figure 4-2 Case 2: Interruptible OB execution

Note

If you configure the OB execution mode to be non-interruptible, then a time error OB cannot interrupt OBs other than program cycle OBs. Prior to V4.0 of the S7-1200 CPU, a time error OB could interrupt any executing OB. With V4.0, you must configure OB execution to be interruptible if you want a time error OB (or any other higher priority OB) to be able to interrupt executing OBs that are not program cycle OBs.

Understanding event execution priorities and queuing

The number of pending (queued) events from a single source is limited, using a different queue for each event type. Upon reaching the limit of pending events for a given event type, the next event is lost. Refer to the topic about time error interrupt OBs (Page 88) for more information regarding queue overflows.

Each CPU event has an associated priority. In general, the CPU services events in order of priority (highest priority first). The CPU services events of the same priority on a "first-come, first-served" basis.

Table 4- 13 OB events

| Event | Quantity allowed | Default OB priority |
|-------------------------|--|-----------------------|
| Program cycle | 1 program cycle event Multiple OBs allowed | 1 ⁴ |
| Startup | 1 startup event ¹ Multiple OBs allowed | 1 ⁴ |
| Time delay | Up to 4 time events 1 OB per event | 3 |
| Cyclic interrupt | Up to 4 events 1 OB per event | 8 |
| Hardware interrupt | Up to 50 hardware interrupt events ² 1 OB per event, but you can use the same OB for multiple events | 18 |
| | | 18 |
| Time error | 1 event (only if configured) ³ | 22 or 26 ⁴ |
| Diagnostic error | 1 event (only if configured) | 5 |
| Pull or plug of modules | 1 event | 6 |
| Rack or station failure | 1 event | 6 |
| Time of day | Up to 2 events | 2 |
| Status | 1 event | 4 |
| Update | 1 event | 4 |
| Profile | 1 event | 4 |

- ¹ The startup event and the program cycle event never occur at the same time because the startup event runs to completion before the program cycle event starts.
- ² You can have more than 50 hardware interrupt event OBs if you use the DETACH and ATTACH instructions.
- ³ You can configure the CPU to stay in RUN if the scan cycle exceeds the maximum scan cycle time or you can use the RE_TRIGR instruction to reset the cycle time. However, the CPU goes to STOP mode the second time that one scan cycle exceeds the maximum scan cycle time.
- ⁴ The priority for a new V4.0 CPU is 22. If you exchange a V3.0 CPU for a V4.0 CPU, the priority is 26, the priority that was in effect for V3.0. In either case, the priority field is editable and you can set the priority to any value in the range 22 to 26.

Refer to the topic "Exchanging a V3.0 CPU for a V4.0 CPU (Page 995)" for more details.

In addition, the CPU recognizes other events that do not have associated OBs. The following table describes these events and the corresponding CPU actions:

Table 4- 14 Additional events

| Event | Description | CPU action |
|-------------------------|---|---|
| I/O access error | Direct I/O read/write error | The CPU logs the first occurrence in the diagnostic buffer and stays in RUN mode. |
| Max cycle time error | CPU exceeds the configured cycle time twice | The CPU logs the error in the diagnostic buffer and transitions to STOP mode. |
| Peripheral access error | I/O error during process image update | The CPU logs the first occurrence in the diagnostic buffer and stays in RUN mode. |
| Programming error | program execution error | If the block with the error provides error handling, it updates the error structure; if not, the CPU logs the error in the diagnostic buffer and stays in RUN mode. |

Interrupt latency

The interrupt event latency (the time from notification of the CPU that an event has occurred until the CPU begins execution of the first instruction in the OB that services the event) is approximately 175 µsec, provided that a program cycle OB is the only event service routine active at the time of the interrupt event.

4.1.4 Monitoring and configuring the cycle time

The cycle time is the time that the CPU operating system requires to execute the cyclic phase of the RUN mode. The CPU provides two methods of monitoring the cycle time:

- Maximum scan cycle time
- Minimum scan cycle time

Scan cycle monitoring begins after the startup event is complete. Configuration for this feature appears under the "Device Configuration" for the CPU under "Cycle time".

The CPU always monitors the scan cycle and reacts if the maximum scan cycle time is exceeded. If the configured maximum scan cycle time is exceeded, an error is generated and is handled one of two ways:

- If the user program does not include a time error interrupt OB, then the timer error event generates a diagnostic buffer entry, but the CPU remains in RUN mode. (You can change the configuration of the CPU to go to STOP mode when it detects a time error, but the default configuration is to remain in RUN mode.)
- If the user program includes a time error interrupt OB, then the CPU executes it.

The RE_TRIGR instruction (Page 262) (re-trigger cycle time monitoring) allows you to reset the timer that measures the cycle time. If the elapsed time for the current program cycle execution is less than ten times the configured maximum scan cycle time, the RE_TRIGR instruction retriggers the cycle time monitoring and returns with ENO = TRUE. If not, the RE_TRIGR instruction does not retrigger the cycle time monitoring. It returns ENO = FALSE.

4.1 Execution of the user program

Typically, the scan cycle executes as fast as it can be executed and the next scan cycle begins as soon as the current one completes. Depending upon the user program and communication tasks, the time period for a scan cycle can vary from scan to scan. To eliminate this variation, the CPU supports an optional minimum scan cycle time. If you enable this optional feature and provide a minimum scan cycle time in ms, then the CPU delays after the execution of the program cycle OBs until the minimum scan cycle time elapses before repeating the program cycle.

In the event that the CPU completes the normal scan cycle in less time than the specified minimum cycle time, the CPU spends the additional time of the scan cycle performing runtime diagnostics and/or processing communication requests.

In the event that the CPU does not complete the scan cycle in the specified minimum cycle time, the CPU completes the scan normally (including communication processing) and does not create any system reaction as a result of exceeding the minimum scan time. The following table defines the ranges and defaults for the cycle time monitoring functions.

Table 4- 15 Range for the cycle time

| Cycle time | Range (ms) | Default |
|--------------------------------------|------------------------------|----------|
| Maximum scan cycle time ¹ | 1 to 6000 | 150 ms |
| Minimum scan cycle time ² | 1 to maximum scan cycle time | Disabled |

- ¹ The maximum scan cycle time is always enabled. Configure a cycle time between 1 ms to 6000 ms. The default is 150 ms.
- ² The minimum scan cycle time is optional, and is disabled by default. If required, configure a cycle time between 1 ms and the maximum scan cycle time.

Configuring the cycle time and communication load

You use the CPU properties in the Device configuration to configure the following parameters:

- **Cycle:** You can enter a maximum scan cycle monitoring time. You can also enable and enter a minimum scan cycle time.

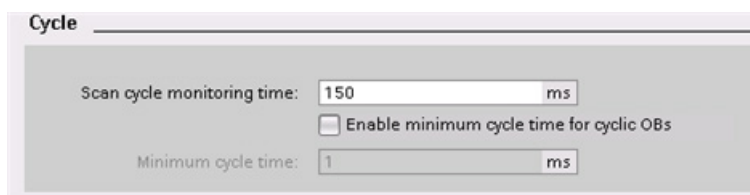

- **Communication load:** You can configure a percentage of the time to be dedicated for communication tasks.



For more information about the scan cycle, see "Monitoring the cycle time". (Page 97)

4.1.5 CPU memory

Memory management

The CPU provides the following memory areas to store the user program, data, and configuration:

- Load memory is non-volatile storage for the user program, data and configuration. When you download a project to the CPU, the CPU first stores the program in the Load memory area. This area is located either in a memory card (if present) or in the CPU. The CPU maintains this non-volatile memory area through a power loss. The memory card supports a larger storage space than that built-in to the CPU.
- Work memory is volatile storage for some elements of the user project while executing the user program. The CPU copies some elements of the project from load memory into work memory. This volatile area is lost when power is removed, and is restored by the CPU when power is restored.
- Retentive memory is non-volatile storage for a limited quantity of work memory values. The CPU uses the retentive memory area to store the values of selected user memory locations during power loss. When a power down or power loss occurs, the CPU restores these retentive values upon power up.

To display the memory usage for a compiled program block, right-click the block in the "Program blocks" folder in the STEP 7 project tree and select "Resources" from the context menu. The Compilation properties display the load memory and work memory for the compiled block.

To display the memory usage for the online CPU, double-click "Online and diagnostics" in STEP 7, expand "Diagnostics", and select "Memory".

Retentive memory

You can avoid data loss after power failure by marking certain data as retentive. The CPU allows you to configure the following data as retentive:

- Bit memory (M): You can define the precise width of the memory for bit memory in the PLC tag table or in the assignment list. Retentive bit memory always starts at MB0 and runs consecutively up through a specified number of bytes. Specify this value from the PLC tag table or in the assignment list by clicking the "Retain" toolbar icon. Enter the number of M bytes to retain starting at MB0.
- Tags of a function block (FB): If an FB was created with "Optimized" selected, then the interface editor for this FB includes a "Retain" column. In this column, you can select either "Retentive", "Non-retentive", or "Set in IDB" individually for each tag. An instance DB that was created when this FB is placed in the program editor shows this retain column as well. You can only change the retentive state of a tag from within the instance DB interface editor if you selected "Set in IDB" (Set in instance data block) in the Retain selection for the tag in the optimized FB.

If an FB was created with "Standard - compatible with S7-300/400" selected, then the interface editor for this FB does not include a "Retain" column. An instance DB created when this FB is inserted in the program editor shows a "Retain" column which is available for edit. In this case, selecting the "Retain" option for any tag results in **all** tags being selected. Similarly, deselecting the option for any tag results in **all** tags being deselected. For an FB that was configured to be "Standard - compatible with S7-300/400", you can change the retentive state from within the instance DB editor, but all tags are set to the same retentive state together.

After you create the FB, you cannot change the option for "Standard - compatible with S7-300/400". You can only select this option when you create the FB. To determine whether an existing FB was configured for "Optimized" or "Standard - compatible with S7-300/400", right-click the FB in the Project tree, select "Properties", and then select "Attributes". The check box "Optimized block access" when selected shows you whether a block is optimized. Otherwise, it is standard and compatible with S7-300/400 CPUs.

- Tags of a global data block: The behavior of a global DB with regard to retentive state assignment is similar to that of an FB. Depending on the block access setting you can define the retentive state either for individual tags or for all tags of a global data block.
 - If you select "Optimized" when you create the DB, you can set the retentive state for each individual tag.
 - If you select "Standard - compatible with S7-300/400" when you create the DB, the retentive-state setting applies to all tags of the DB; either all tags are retentive or no tag is retentive.

The CPU supports a total of 10240 bytes of retentive data. To see how much is available, from the PLC tag table or the assignment list, click on the "Retain" toolbar icon. Although this is where the retentive range is specified for M memory, the second row indicates the total remaining memory available for M and DB combined. Note that for this value to be accurate, you must compile all data blocks with retentive tags.

Note

Downloading a program does not clear or make any changes to existing values in retentive memory. If you want to clear retentive memory before a download, then reset your CPU to factory settings prior to downloading the program.

4.1.5.1 System and clock memory

You use the CPU properties to enable bytes for "system memory" and "clock memory". Your program logic can reference the individual bits of these functions by their tag names.

- You can assign one byte in M memory for system memory. The byte of system memory provides the following four bits that can be referenced by your user program by the following tag names:
 - First cycle: (Tag name "FirstScan") bit is set to 1 for the duration of the first scan after the startup OB finishes. (After the execution of the first scan, the "first scan" bit is set to 0.)
 - Diagnostics status changed (Tag name: "DiagStatusUpdate") is set to 1 for one scan after the CPU logs a diagnostic event. Because the CPU does not set the "diagnostic graph changed" bit until the end of the first execution of the program cycle OBs, your user program cannot detect if there has been a diagnostic change either during the execution of the startup OBs or the first execution of the program cycle OBs.
 - Always 1 (high): (Tag name "AlwaysTRUE") bit is always set to 1.
 - Always 0 (low): (Tag name "AlwaysFALSE") bit is always set to 0.
- You can assign one byte in M memory for clock memory. Each bit of the byte configured as clock memory generates a square wave pulse. The byte of clock memory provides 8 different frequencies, from 0.5 Hz (slow) to 10 Hz (fast). You can use these bits as control bits, especially when combined with edge instructions, to trigger actions in the user program on a cyclic basis.

4.1 Execution of the user program

The CPU initializes these bytes on the transition from STOP mode to STARTUP mode. The bits of the clock memory change synchronously to the CPU clock throughout the STARTUP and RUN modes.

⚠ CAUTION

Risks with overwriting the system memory or clock memory bits

Overwriting the system memory or clock memory bits can corrupt the data in these functions and cause your user program to operate incorrectly, which can cause damage to equipment and injury to personnel.

Because both the clock memory and system memory are unreserved in M memory, instructions or communications can write to these locations and corrupt the data.

Avoid writing data to these locations to ensure the proper operation of these functions, and always implement an emergency stop circuit for your process or machine.

System memory configures a byte with bits that turn on (value = 1) for a specific event.

System memory bits

Enable the use of system memory byte

Address of system memory byte (MBx):

First cycle:

Diagnostics status changed:

Always 1 (high):

Always 0 (low):

Table 4- 16 System memory

| 7 | 6 | 5 | 4 | 3 | 2 | 1 | 0 |
|---------------------|---|---|---|-----------------------|----------------------|---|---|
| Reserved Value 0 | | | | Always off Value 0 | Always on Value 1 | Diagnostic status indicator <ul style="list-style-type: none"> • 1: Change • 0: No change | First scan indicator <ul style="list-style-type: none"> • 1: First scan after startup • 0: Not first scan |

Clock memory configures a byte that cycles the individual bits on and off at fixed intervals. Each clock bit generates a square wave pulse on the corresponding M memory bit. These bits can be used as control bits, especially when combined with edge instructions, to trigger actions in the user code on a cyclic basis.

Clock memory bits

Enable the use of clock memory byte

Address of clock memory byte (MBx):

10 Hz clock:

5 Hz clock:

2.5 Hz clock:

2 Hz clock:

1.25 Hz clock:

1 Hz clock:

0.625 Hz clock:

0.5 Hz clock:

Table 4- 17 Clock memory

| Bit number | 7 | 6 | 5 | 4 | 3 | 2 | 1 | 0 |
|----------------|-----|-------|-----|------|-----|-----|-----|-----|
| Tag name | | | | | | | | |
| Period (s) | 2.0 | 1.6 | 1.0 | 0.8 | 0.5 | 0.4 | 0.2 | 0.1 |
| Frequency (Hz) | 0.5 | 0.625 | 1 | 1.25 | 2 | 2.5 | 5 | 10 |

Because clock memory runs asynchronously to the CPU cycle, the status of the clock memory can change several times during a long cycle.

4.1.6 Diagnostics buffer

The CPU supports a diagnostics buffer which contains an entry for each diagnostic event. Each entry includes a date and time the event occurred, an event category, and an event description. The entries are displayed in chronological order with the most recent event at the top. Up to 50 most recent events are available in this log. When the log is full, a new event replaces the oldest event in the log. When power is lost, the events are saved.

The following types of events are recorded in the diagnostics buffer:

- Each system diagnostic event; for example, CPU errors and module errors
- Each state change of the CPU (each power up, each transition to STOP, each transition to RUN)

To access the diagnostics buffer (Page 793), you must be online. From the "Online & diagnostics" view, locate the diagnostics buffer under "Diagnostics > Diagnostics buffer".

4.1.7 Time of day clock

The CPU supports a time-of-day clock. A super-capacitor supplies the energy required to keep the clock running during times when the CPU is powered down. The super-capacitor charges while the CPU has power. After the CPU has been powered up at least 24 hours, then the super-capacitor has sufficient charge to keep the clock running for typically 20 days.

STEP 7 sets the time-of-day clock to system time, which has a default value out of the box or following a factory reset. To utilize the time-of-day clock, you must set it. Timestamps such as those for diagnostic buffer entries, data log files, and data log entries are based on the system time. You set the time of day from the "Set time of day" function (Page 789) in the "Online & diagnostics" view of the online CPU. STEP 7 then calculates the system time from the time you set plus or minus the Windows operating system offset from UTC (Coordinated Universal Time). Setting the time of day to the current local time produces a system time of UTC if your Windows operating system settings for time zone and daylight savings time correspond to your locale.

STEP 7 includes instructions (Page 286) to read and write the system time (RD_SYS_T and WR_SYS_T), to read the local time (RD_LOC_T), and to set the time zone (SET_TIMEZONE). The RD_LOC_T instruction calculates local time using the time zone and daylight saving time offsets that you set in the "Time of day" configuration in the general properties of the CPU (Page 142). These settings enable you to set your time zone for local time, optionally enable daylight saving time, and specify the start and end dates and times for daylight saving time. You can also use the SET_TIMEZONE instructions to configure these settings.

4.1.8 Configuring the outputs on a RUN-to-STOP transition

You can configure the behavior of the digital and analog outputs when the CPU is in STOP mode. For any output of a CPU, SB or SM, you can set the outputs to either freeze the value or use a substitute value:

- Substituting a specified output value (default): You enter a substitute value for each output (channel) of that CPU, SB, or SM device.

The default substitute value for digital output channels is OFF, and the default substitute value for analog output channels is 0.

- Freezing the outputs to remain in last state: The outputs retain their current value at the time of the transition from RUN to STOP. After power up, the outputs are set to the default substitute value.

You configure the behavior of the outputs in Device Configuration. Select the individual devices and use the "Properties" tab to configure the outputs for each device.

When the CPU changes from RUN to STOP, the CPU retains the process image and writes the appropriate values for both the digital and analog outputs, based upon the configuration.

4.2 Data storage, memory areas, I/O and addressing

4.2.1 Accessing the data of the S7-1200

STEP 7 facilitates symbolic programming. You create symbolic names or "tags" for the addresses of the data, whether as PLC tags relating to memory addresses and I/O points or as local variables used within a code block. To use these tags in your user program, simply enter the tag name for the instruction parameter.

For a better understanding of how the CPU structures and addresses the memory areas, the following paragraphs explain the "absolute" addressing that is referenced by the PLC tags. The CPU provides several options for storing data during the execution of the user program:

- **Global memory:** The CPU provides a variety of specialized memory areas, including inputs (I), outputs (Q) and bit memory (M). This memory is accessible by all code blocks without restriction.
- **PLC tag table:** You can enter symbolic names in the STEP 7 PLC tag table for specific memory locations. These tags are global to the STEP 7 program and allow programming with names that are meaningful for your application.
- **Data block (DB):** You can include DBs in your user program to store data for the code blocks. The data stored persists when the execution of the associated code block comes to an end. A "global" DB stores data that can be used by all code blocks, while an instance DB stores data for a specific FB and is structured by the parameters for the FB.
- **Temp memory:** Whenever a code block is called, the operating system of the CPU allocates the temporary, or local, memory (L) to be used during the execution of the block. When the execution of the code block finishes, the CPU reallocates the local memory for the execution of other code blocks.

Each different memory location has a unique address. Your user program uses these addresses to access the information in the memory location. References to the input (I) or output (Q) memory areas, such as I0.3 or Q1.7, access the process image. To immediately access the physical input or output, append the reference with ":P" (such as I0.3:P, Q1.7:P, or "Stop:P").

Table 4- 18 Memory areas

| Memory area | Description | Force | Retentive |
|-----------------------------|--|-------|-------------------|
| I Process image input | Copied from physical inputs at the beginning of the scan cycle | No | No |
| I_:P 1 (Physical input) | Immediate read of the physical input points on the CPU, SB, and SM | Yes | No |
| Q Process image output | Copied to physical outputs at the beginning of the scan cycle | No | No |
| Q_:P 1 (Physical output) | Immediate write to the physical output points on the CPU, SB, and SM | Yes | No |
| M Bit memory | Control and data memory | No | Yes (optional) |

| Memory area | Description | Force | Retentive |
|------------------|--|-------|----------------|
| L Temp memory | Temporary data for a block local to that block | No | No |
| DB Data block | Data memory and also parameter memory for FBs | No | Yes (optional) |

¹ To immediately access (read or write) the physical inputs and physical outputs, append a ":P" to the address or tag (such as I0.3:P, Q1.7:P, or "Stop:P").

Each different memory location has a unique address. Your user program uses these addresses to access the information in the memory location. The absolute address consists of the following elements:

- Memory area identifier (such as I, Q, or M)
- Size of the data to be accessed ("B" for Byte, "W" for Word, or "D" for DWord)
- Starting address of the data (such as byte 3 or word 3)

When accessing a bit in the address for a Boolean value, you do not enter a mnemonic for the size. You enter only the memory area, the byte location, and the bit location for the data (such as I0.0, Q0.1, or M3.4).

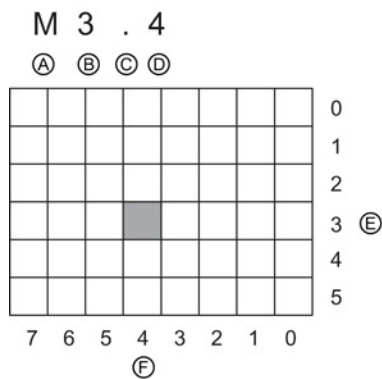

- | | | | |
|---|---------------------------------------|---|---------------------------|
| A | Memory area identifier | E | Bytes of the memory area |
| B | Byte address: byte 3 | F | Bits of the selected byte |
| C | Separator ("byte.bit") | | |
| D | Bit location of the byte (bit 4 of 8) | | |

In the example, the memory area and byte address (M = bit memory area, and 3 = Byte 3) are followed by a period (".") to separate the bit address (bit 4).

Accessing the data in the memory areas of the CPU

STEP 7 facilitates symbolic programming. Typically, tags are created either in PLC tags, a data block, or in the interface at the top of an OB, FC, or FB. These tags include a name, data type, offset, and comment. Additionally, in a data block, a start value can be specified. You can use these tags when programming by entering the tag name at the instruction parameter. Optionally you can enter the absolute operand (memory area, size and offset) at the instruction parameter. The examples in the following sections show how to enter absolute operands. The % character is inserted automatically in front of the absolute operand by the program editor. You can toggle the view in the program editor to one of these: symbolic, symbolic and absolute, or absolute.

I (process image input): The CPU samples the peripheral (physical) input points just prior to the cyclic OB execution of each scan cycle and writes these values to the input process image. You can access the input process image as bits, bytes, words, or double words. Both read and write access is permitted, but typically, process image inputs are only read.

Table 4- 19 Absolute addressing for I memory

| | | |
|----------------------------|--------------------------------|-------------------|
| Bit | I[byte address].[bit address] | I0.1 |
| Byte, Word, or Double Word | I[size][starting byte address] | IB4, IW5, or ID12 |

By appending a ":P" to the address, you can immediately read the digital and analog inputs of the CPU, SB or SM. The difference between an access using I_:P instead of I is that the data comes directly from the points being accessed rather than from the input process image. This I_:P access is referred to as an "immediate read" access because the data is retrieved immediately from the source instead of from a copy that was made the last time the input process image was updated.

Because the physical input points receive their values directly from the field devices connected to these points, writing to these points is prohibited. That is, I_:P accesses are read-only, as opposed to I accesses which can be read or write.

I_:P accesses are also restricted to the size of inputs supported by a single CPU, SB, or SM, rounded up to the nearest byte. For example, if the inputs of a 2 DI / 2 DQ SB are configured to start at I4.0, then the input points can be accessed as I4.0:P and I4.1:P or as IB4:P. Accesses to I4.2:P through I4.7:P are not rejected, but make no sense since these points are not used. Accesses to IW4:P and ID4:P are prohibited since they exceed the byte offset associated with the SB.

Accesses using I_:P do not affect the corresponding value stored in the input process image.

Table 4- 20 Absolute addressing for I memory (immediate)

| | | |
|----------------------------|----------------------------------|-------------------------|
| Bit | I[byte address].[bit address]:P | I0.1:P |
| Byte, Word, or Double word | I[size][starting byte address]:P | IB4:P, IW5:P, or ID12:P |

Q (process image output): The CPU copies the values stored in the output process image to the physical output points. You can access the output process image in bits, bytes, words, or double words. Both read and write access is permitted for process image outputs.

Table 4- 21 Absolute addressing for Q memory

| | | |
|----------------------------|--------------------------------|-----------------|
| Bit | Q[byte address].[bit address] | Q1.1 |
| Byte, Word, or Double word | Q[size][starting byte address] | QB5, QW10, QD40 |

By appending a ":P" to the address, you can immediately write to the physical digital and analog outputs of the CPU, SB or SM. The difference between an access using Q_:P instead of Q is that the data goes directly to the points being accessed in addition to the output process image (writes to both places). This Q_:P access is sometimes referred to as an "immediate write" access because the data is sent immediately to the target point; the target point does not have to wait for the next update from the output process image.

Because the physical output points directly control field devices that are connected to these points, reading from these points is prohibited. That is, Q_:P accesses are write-only, as opposed to Q accesses which can be read or write.

Q_:P accesses are also restricted to the size of outputs supported by a single CPU, SB, or SM, rounded up to the nearest byte. For example, if the outputs of a 2 DI / 2 DQ SB are configured to start at Q4.0, then the output points can be accessed as Q4.0:P and Q4.1:P or as QB4:P. Accesses to Q4.2:P through Q4.7:P are not rejected, but make no sense since these points are not used. Accesses to QW4:P and QD4:P are prohibited since they exceed the byte offset associated with the SB.

Accesses using Q_:P affect both the physical output as well as the corresponding value stored in the output process image.

Table 4- 22 Absolute addressing for Q memory (immediate)

| | | |
|----------------------------|----------------------------------|-------------------------|
| Bit | Q[byte address].[bit address]:P | Q1.1:P |
| Byte, Word, or Double word | Q[size][starting byte address]:P | QB5:P, QW10:P or QD40:P |

M (bit memory area): Use the bit memory area (M memory) for both control relays and data to store the intermediate status of an operation or other control information. You can access the bit memory area in bits, bytes, words, or double words. Both read and write access is permitted for M memory.

Table 4- 23 Absolute addressing for M memory

| | | |
|----------------------------|--------------------------------|------------------|
| Bit | M[byte address].[bit address] | M26.7 |
| Byte, Word, or Double Word | M[size][starting byte address] | MB20, MW30, MD50 |

Temp (temporary memory): The CPU allocates the temp memory on an as-needed basis. The CPU allocates the temp memory for the code block and initializes the memory locations to 0 at the time when it starts the code block (for an OB) or calls the code block (for an FC or FB).

Temp memory is similar to M memory with one major exception: M memory has a "global" scope, and temp memory has a "local" scope:

- M memory: Any OB, FC, or FB can access the data in M memory, meaning that the data is available globally for all of the elements of the user program.
- Temp memory: The CPU restricts access to the data in temp memory to the OB, FC, or FB that created or declared the temp memory location. Temp memory locations remain local and different code blocks do not share temp memory, even when the code block calls another code block. For example: When an OB calls an FC, the FC cannot access the temp memory of the OB that called it.

The CPU provides temp (local) memory for each OB priority level:

- 16 Kbytes for startup and program cycle, including associated FBs and FCs
- 6 Kbytes for each additional interrupt event thread, including associated FBs and FCs

You access temp memory by symbolic addressing only.

DB (data block): Use the DB memory for storing various types of data, including intermediate status of an operation or other control information parameters for FBs, and data structures required for many instructions such as timers and counters. You can access data block memory in bits, bytes, words, or double words. Both read and write access is permitted for read/write data blocks. Only read access is permitted for read-only data blocks.

Table 4- 24 Absolute addressing for DB memory

| | | |
|----------------------------|--|--------------------------------|
| Bit | DB[data block number].DBX[byte address].[bit address] | DB1.DBX2.3 |
| Byte, Word, or Double Word | DB[data block number].DB [size][starting byte address] | DB1.DBB4, DB10.DBW2, DB20.DBD8 |

Note

When you specify an absolute address in LAD or FBD, STEP 7 precedes this address with a "%" character to indicate that it is an absolute address. While programming, you can enter an absolute address either with or without the "%" character (for example %I0.0 or I.0). If omitted, STEP 7 supplies the "%" character.

In SCL, you must enter the "%" before the address to indicate that it is an absolute address. Without the "%", STEP 7 generates an undefined tag error at compile time

Configuring the I/O in the CPU and I/O modules



| Module | Slot | I address | Q address | Type | Order |
|---------------|------|-----------|-----------|---------------------|-------|
| | 103 | | | | |
| | 102 | | | | |
| RS485_1 | 101 | | | CM 1241 (RS485) | 6ES7 |
| PLC_1 | 1 | | | CPU 1214C DC/DC | 6ES7 |
| DI14/DO10 | 1.1 | 0..1 | 0..1 | DI14/DO10 | |
| AI2 | 1.2 | 64..67 | | AI2 | |
| AO1 x 12bit | 1.3 | | 80..81 | AO1 signal board | 6ES7 |
| HSC_1 | 1.16 | 1000..... | | High speed counts | |
| HSC_2 | 1.17 | | | High speed counts | |
| HSC_3 | 1.18 | | | High speed counts | |
| HSC_4 | 1.19 | | | High speed counts | |
| HSC_5 | 1.20 | | | High speed counts | |
| HSC_6 | 1.21 | | | High speed counts | |
| Pulse_1 | 1.32 | | | Pulse generator (P) | |
| Pulse_2 | 1.33 | | | Pulse generator (P) | |
| PROFINET L X1 | | | | PROFINET interface | |
| DI8 x 24VDC | 2 | 8 | | SM 1221 DI8 x 24V | 6ES7 |

When you add a CPU and I/O modules to your configuration screen, I and Q addresses are automatically assigned. You can change the default addressing by selecting the address field in the device configuration and typing new numbers.

- Digital inputs and outputs are assigned in groups of 8 points (1 byte), whether the module uses all the points or not.
- Analog inputs and outputs are assigned in groups of 2 points (4 bytes).

The figure shows an example of a CPU 1214C with two SMs and one SB. In this example, you could change the address of the DI8 module to 2 instead of 8. The tool assists you by changing address ranges that are the wrong size or conflict with other addresses.

4.3 Processing of analog values

Analog signal modules provide input signals or expect output values that represent either a voltage range or a current range. These ranges are ± 10 V, ± 5 V, ± 2.5 V, or 0 - 20 mA. The values returned by the modules are integer values where 0 to 27648 represents the rated range for current, and -27648 to 27648 for voltage. Anything outside the range represents either an overflow or underflow. See the tables for analog input representation (Page 916) and analog output representation (Page 917) for details.

In your control program, you probably need to use these values in engineering units, for example to represent a volume, temperature, weight or other quantitative value. To do this for an analog input, you must first normalize the analog value to a real (floating point) value from 0.0 to 1.0. Then you must scale it to the minimum and maximum values of the engineering units that it represents. For values that are in engineering units that you need to convert to an analog output value, you first normalize the value in engineering units to a value between 0.0 and 1.0, and then scale it between 0 and 27648 or -27648 to 27648, depending on the range of the analog module. STEP 7 provides the NORM_X and SCALE_X instructions (Page 251) for this purpose. You can also use the CALCULATE instruction (Page 229) to scale the analog values (Page 39).

4.4 Data types

Data types are used to specify both the size of a data element as well as how the data are to be interpreted. Each instruction parameter supports at least one data type, and some parameters support multiple data types. Hold the cursor over the parameter field of an instruction to see which data types are supported for a given parameter.

A formal parameter is the identifier on an instruction that marks the location of data to be used by that instruction (example: the IN1 input of an ADD instruction). An actual parameter is the memory location (preceded by a "%" character) or constant containing the data to be used by the instruction (example %MD400 "Number_of_Widgets"). The data type of the actual parameter specified by you must match one of the supported data types of the formal parameter specified by the instruction.

When specifying an actual parameter, you must specify either a tag (symbol) or an absolute (direct) memory address. Tags associate a symbolic name (tag name) with a data type, memory area, memory offset, and comment, and can be created either in the PLC tags editor or in the Interface editor for a block (OB, FC, FB and DB). If you enter an absolute address that has no associated tag, you must use an appropriate size that matches a supported data type, and a default tag will be created upon entry.

All data types except String, Struct, Array, and DTL are available in the PLC tags editor and the block Interface editors. String, Struct, Array, and DTL are available only in the block Interface editors. You can also enter a constant value for many of the input parameters.

- Bit and Bit sequences (Page 111): Bool (Boolean or bit value), Byte (8-bit byte value), Word (16-bit value), DWord (32-bit double-word value)
- Integer (Page 112)
 - USInt (unsigned 8-bit integer), SInt (signed 8-bit integer),
 - UInt (unsigned 16-bit integer), Int (signed 16-bit integer)
 - UDInt (unsigned 32-bit integer), DInt (signed 32-bit integer)

- Floating-point Real (Page 112): Real (32-bit Real or floating-point value), LReal (64-bit Real or floating-point value)
- Time and Date (Page 113): Time (32-bit IEC time value), Date (16-bit date value), TOD (32-bit time-of-day value), DTL (12-byte date-and-time structure)
- Character and String (Page 114): Char (8-bit single character), String (variable-length string of up to 254 characters)
- Array (Page 116)
- Data structure (Page 117): Struct
- PLC Data type (Page 117)
- Pointers (Page 118): Pointer, Any, Variant

Although not available as data types, the following BCD numeric format is supported by the conversion instructions.

Table 4- 25 Size and range of the BCD format

| Format | Size (bits) | Numeric Range | Constant Entry Examples |
|--------|-------------|---------------------|-------------------------|
| BCD16 | 16 | -999 to 999 | 123, -123 |
| BCD32 | 32 | -9999999 to 9999999 | 1234567, -1234567 |

4.4.1 Bool, Byte, Word, and DWord data types

Table 4- 26 Bit and bit sequence data types

| Data type | Bit size | Number type | Number range | Constant examples | Address examples |
|-----------|----------|------------------|--|----------------------------|---|
| Bool | 1 | Boolean | FALSE or TRUE | TRUE, 1, | I1.0 Q0.1 M50.7 DB1.DBX2.3 Tag_name |
| | | Binary | 0 or 1 | 0, 2#0 | |
| | | Octal | 8#0 or 8#1 | 8#1 | |
| | | Hexadecimal | 16#0 or 16#1 | 16#1 | |
| Byte | 8 | Binary | 2#0 to 2#11111111 | 2#00001111 | IB2 MB10 DB1.DBB4 Tag_name |
| | | Unsigned integer | 0 to 255 | 15 | |
| | | Octal | 8#0 to 8#377 | 8#17 | |
| | | Hexadecimal | B#16#0 to B#16#FF | B#16#F, 16#F | |
| Word | 16 | Binary | 2#0 to 2#1111111111111111 | 2#1111000011110000 | MW10 DB1.DBW2 Tag_name |
| | | Unsigned integer | 0 to 65535 | 61680 | |
| | | Octal | 8#0 to 8#177777 | 8#170360 | |
| | | Hexadecimal | W#16#0 to W#16#FFFF, 16#0 to 16#FFFF | W#16#F0F0, 16#F0F0 | |
| DWord | 32 | Binary | 2#0 to 2#11111111111111111111111111111111 | 2#111100001111111100001111 | MD10 DB1.DBD8 Tag_name |
| | | Unsigned integer | 0 to 4294967295 | 15793935 | |

| Data type | Bit size | Number type | Number range | Constant examples | Address examples |
|-----------|----------|-------------|--|-------------------------|------------------|
| | | Octal | 8#0 to 8#3777777777 | 8#74177417 | |
| | | Hexadecimal | DW#16#0000_0000 to DW#16#FFFF_FFFF, 16#0000_0000 to 16#FFFF_FFFF | DW#16#F0FF0F, 16#F0FF0F | |

4.4.2 Integer data types

Table 4- 27 Integer data types (U = unsigned, S = short, D= double)

| Data type | Bit size | Number Range | Constant examples | Address examples |
|-----------|----------|---------------------------------|-------------------|-------------------------|
| USInt | 8 | 0 to 255 | 78, 2#01001110 | MB0, DB1.DBB4, Tag_name |
| SInt | 8 | -128 to 127 | +50, 16#50 | |
| UInt | 16 | 0 to 65,535 | 65295, 0 | MW2, DB1.DBW2, Tag_name |
| Int | 16 | -32,768 to 32,767 | 30000, +30000 | |
| UDInt | 32 | 0 to 4,294,967,295 | 4042322160 | MD6, DB1.DBD8, Tag_name |
| DInt | 32 | -2,147,483,648 to 2,147,483,647 | -2131754992 | |

4.4.3 Floating-point real data types

Real (or floating-point) numbers are represented as 32-bit single-precision numbers (Real), or 64-bit double-precision numbers (LReal) as described in the ANSI/IEEE 754-1985 standard. Single-precision floating-point numbers are accurate up to 6 significant digits and double-precision floating point numbers are accurate up to 15 significant digits. You can specify a maximum of 6 significant digits (Real) or 15 (LReal) when entering a floating-point constant to maintain precision.

Table 4- 28 Floating-point real data types (L=Long)

| Data type | Bit size | Number range | Constant Examples | Address examples |
|-----------|----------|--|-----------------------------|---|
| Real | 32 | -3.402823e+38 to -1.175 495e-38, ±0, +1.175 495e-38 to +3.402823e+38 | 123.456, -3.4, 1.0e-5 | MD100, DB1.DBD8, Tag_name |
| LReal | 64 | -1.7976931348623158e+308 to -2.2250738585072014e-308, ±0, +2.2250738585072014e-308 to +1.7976931348623158e+308 | 12345.123456789e40, 1.2E+40 | DB_name.var_name Rules: <ul style="list-style-type: none"> No direct addressing support Can be assigned in an OB, FB, or FC block interface table |

Calculations that involve a long series of values including very large and very small numbers can produce inaccurate results. This can occur if the numbers differ by 10 to the power of x , where $x > 6$ (Real), or 15 (LReal). For example (Real): $100\,000\,000 + 1 = 100\,000\,000$.

4.4.4 Time and Date data types

Table 4- 29 Time and date data types

| Data type | Size | Range | Constant Entry Examples |
|-----------------------------|----------|---|--|
| Time | 32 bits | T#-24d_20h_31m_23s_648ms to T#24d_20h_31m_23s_647ms Stored as: -2,147,483,648 ms to +2,147,483,647 ms | T#5m_30s T#1d_2h_15m_30s_45ms TIME#10d20h30m20s630ms 500h10000ms 10d20h30m20s630ms |
| Date | 16 bits | D#1990-1-1 to D#2168-12-31 | D#2009-12-31 DATE#2009-12-31 2009-12-31 |
| Time_of_Day | 32 bits | TOD#0:0:0.0 to TOD#23:59:59.999 | TOD#10:20:30.400 TIME_OF_DAY#10:20:30.400 23:10:1 |
| DTL (Date and Time Long) | 12 bytes | Min.: DTL#1970-01-01-00:00:00.0 Max.: DTL#2554-12-31-23:59:59.999 999 999 | DTL#2008-12-16-20:30:20.250 |

Time

TIME data is stored as a signed double integer interpreted as milliseconds. The editor format can use information for day (d), hours (h), minutes (m), seconds (s) and milliseconds (ms).

It is not necessary to specify all units of time. For example T#5h10s and 500h are valid.

The combined value of all specified unit values cannot exceed the upper or lower limits in milliseconds for the Time data type (-2,147,483,648 ms to +2,147,483,647 ms).

Date

DATE data is stored as an unsigned integer value which is interpreted as the number of days added to the base date 01/01/1990, to obtain the specified date. The editor format must specify a year, month and day.

TOD

TOD (TIME_OF_DAY) data is stored as an unsigned double integer which is interpreted as the number of milliseconds since midnight for the specified time of day (Midnight = 0 ms). The hour (24hr/day), minute, and second must be specified. The fractional second specification is optional.

DTL

DTL (Date and Time Long) data type uses a 12 byte structure that saves information on date and time. You can define DTL data in either the Temp memory of a block or in a DB. A value for all components must be entered in the "Start value" column of the DB editor.

Table 4- 30 Size and range for DTL

| Length (bytes) | Format | Value range | Example of value input |
|----------------|---|---|-----------------------------|
| 12 | Clock and calendar Year-Month-Day:Hour:Minute: Second.Nanoseconds | Min.: DTL#1970-01-01-00:00:00.0 Max.: DTL#2554-12-31-23:59:59.999 999 999 | DTL#2008-12-16-20:30:20.250 |

Each component of the DTL contains a different data type and range of values. The data type of a specified value must match the data type of the corresponding components.

Table 4- 31 Elements of the DTL structure

| Byte | Component | Data type | Value range |
|------|----------------------|-----------|---------------------------------------|
| 0 | Year | UINT | 1970 to 2554 |
| 1 | | | |
| 2 | Month | USINT | 1 to 12 |
| 3 | Day | USINT | 1 to 31 |
| 4 | Weekday ¹ | USINT | 1(Sunday) to 7(Saturday) ¹ |
| 5 | Hour | USINT | 0 to 23 |
| 6 | Minute | USINT | 0 to 59 |
| 7 | Second | USINT | 0 to 59 |
| 8 | Nanoseconds | UDINT | 0 to 999 999 999 |
| 9 | | | |
| 10 | | | |
| 11 | | | |

¹ The weekday is not considered in the value entry.

4.4.5 Character and String data types

Table 4- 32 Character and String data types

| Data type | Size | Range | Constant Entry Examples |
|-----------|------------|---------------------------------------|-------------------------|
| Char | 8 bits | ASCII character codes: 16#00 to 16#FF | 'A', 't', '@' |
| String | n+ 2 bytes | n = (0 to 254 character bytes) | 'ABC' |

Char

Char data occupies one byte in memory and stores a single character coded in ASCII format. The editor syntax uses a single quote character before and after the ASCII character. Visible characters and control characters can be used. A table of valid control characters is shown in the description of the String data type.

String

The CPU supports the String data type for storing a sequence of single-byte characters. The String data type contains a total character count (number of characters in the string) and the current character count. The String type provides up to 256 bytes for storing the maximum total character count (1 byte), the current character count (1 byte), and up to 254 characters, with each character stored in 1 byte.

You can use literal strings (constants) for instruction parameters of type IN using single quotes. For example, 'ABC' is a three-character string that could be used as input for parameter IN of the S_CONV instruction. You can also create string variables by selecting data type "String" in the block interface editors for OB, FC, FB, and DB. You cannot create a string in the PLC tags editor.

You can specify the maximum string size in bytes by entering square brackets after the keyword "String" (once the data type "String" is selected from a data type drop-list). For example, "MyString String[10]" would specify a 10-byte maximum size for MyString. If you do not include the square brackets with a maximum size, then 254 is assumed.

The following example defines a String with maximum character count of 10 and current character count of 3. This means the String currently contains 3 one-byte characters, but could be expanded to contain up to 10 one-byte characters.

Table 4- 33 Example of a String data type

| Total Character Count | Current Character Count | Character 1 | Character 2 | Character 3 | ... | Character 10 |
|-----------------------|-------------------------|-------------|-------------|-------------|-----|--------------|
| 10 | 3 | 'C' (16#43) | 'A' (16#41) | 'T' (16#54) | ... | - |
| Byte 0 | Byte 1 | Byte 2 | Byte 3 | Byte 4 | ... | Byte 11 |

ASCII control characters can be used in Char and String data. The following table shows examples of control character syntax.

Table 4- 34 Valid ASCII control characters

| Control characters | ASCII Hex value | Control function | Examples |
|--------------------|-----------------|--|-----------------------------|
| \$L or \$l | 0A | Line feed | '\$LText', '\$0AText' |
| \$N or \$n | 0A and 0D | Line break The new line shows two characters in the string. | '\$NText', '\$0A\$0DText' |
| \$P or \$p | 0C | Form feed | '\$PText', '\$0CText' |
| \$R or \$r | 0D | Carriage return (CR) | '\$RText', '\$0DText' |
| \$T or \$t | 09 | Tab | '\$TText', '\$09Text' |
| \$\$ | 24 | Dollar sign | '100\$\$', '100\$24' |
| \$' | 27 | Single quote | '\$'Text\$', '\$27Text\$27' |

4.4.6 Array data type

Arrays

You can create an array that contains multiple elements of the same data type. Arrays can be created in the block interface editors for OB, FC, FB, and DB. You cannot create an array in the PLC tags editor.

To create an array from the block interface editor, name the array and choose data type "Array [lo .. hi] of type", then edit "lo", "hi", and "type" as follows:

- lo - the starting (lowest) index for your array
- hi - the ending (highest) index for your array
- type - one of the data types, such as BOOL, SINT, UDINT

Table 4- 35 ARRAY data type rules

| Data Type | Array syntax | | |
|-----------|--|-------------------------------------|--|
| ARRAY | Name [index1_min..index1_max, index2_min..index2_max] of <data type> | | |
| | <ul style="list-style-type: none"> • All array elements must be the same data type. • The index can be negative, but the lower limit must be less than or equal to the upper limit. • Arrays can have one to six dimensions. • Multi-dimensional index min..max declarations are separated by comma characters. • Nested arrays, or arrays of arrays, are not allowed. • The memory size of an array = (size of one element * total number of elements in array) | | |
| | Array index | Valid index data types | Array index rules |
| | Constant or variable | USInt, SInt, UInt, Int, UDInt, DInt | <ul style="list-style-type: none"> • Value limits: -32768 to +32767 • Valid: Mixed constants and variables • Valid: Constant expressions • Not valid: Variable expressions |

| | | |
|------------------------------------|---------------------------|--|
| Example: array declarations | ARRAY[1..20] of REAL | One dimension, 20 elements |
| | ARRAY[-5..5] of INT | One dimension, 11 elements |
| | ARRAY[1..2, 3..4] of CHAR | Two dimensions, 4 elements |
| Example: array addresses | ARRAY1[0] | ARRAY1 element 0 |
| | ARRAY2[1,2] | ARRAY2 element [1,2] |
| | ARRAY3[i,j] | If i =3 and j=4, then ARRAY3 element [3, 4] is addressed |

4.4.7 Data structure data type

You can use the data type "Struct" to define a structure of data consisting of other data types. The struct data type can be used to handle a group of related process data as a single data unit. A Struct data type is named and the internal data structure declared in the data block editor or a block interface editor.

Arrays and structures can also be assembled into a larger structure. A structure can be nested up to eight levels deep. For example, you can create a structure of structures that contain arrays.

4.4.8 PLC data type

The PLC data type editor lets you define data structures that you can use multiple times in your program. You create a PLC data type by opening the "PLC data types" branch of the project tree and double-clicking the "Add new data type" item. On the newly created PLC data type item, use two single-clicks to rename the default name and double-click to open the PLC data type editor.

You create a custom PLC data type structure using the same editing methods that are used in the data block editor. Add new rows for any data types that are necessary to create the data structure that you want.

If a new PLC data type is created, then the new PLC type name will appear in the data type selector drop drop-lists in the DB editor and code block interface editor.

Potential uses of PLC data types:

- PLC data types can be used directly as a data type in a code block interface or in data blocks.
- PLC data types can be used as a template for the creation of multiple global data blocks that use the same data structure.

For example, a PLC data type could be a recipe for mixing colors. You can then assign this PLC data type to multiple data blocks. Each data block can then have the variables adjusted to create a specific color.

4.4.9 Pointer data types

The pointer data types (Pointer, Any, and Variant) can be used in the block interface tables for FB and FC code blocks. You can select a pointer data type from the block interface data type drop-lists.

The Variant data type is also used for instruction parameters.

4.4.9.1 "Pointer" pointer data type

The data type Pointer points to a particular variable. It occupies 6 bytes (48 bits) in memory and can include the following information:

- DB number or 0 if the data is not stored in a DB
- Storage area in the CPU
- Variable address

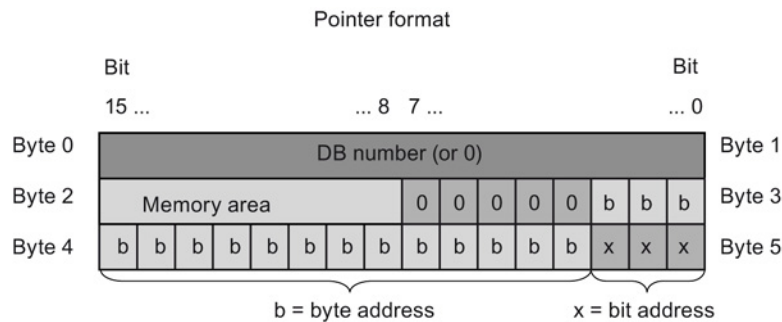

Depending on the instruction, you can declare the following three types of pointers:

- Area-internal pointer: contains data on the address of a variable
- Area-crossing pointer: contains data on the memory area and the address of a variable
- DB-pointer: contains a data block number and the address of a variable

Table 4- 36 Pointer types:

| Type | Format | Example entry |
|-----------------------|---------------------------|----------------|
| Area-internal pointer | P#Byte.Bit | P#20.0 |
| Area-crossing pointer | P#Memory_area_Byte.Bit | P#M20.0 |
| DB-pointer | P#Data_block.Data_element | P#DB10.DBX20.0 |

You can enter a parameter of type Pointer without the prefix (P #). Your entry will be automatically converted to the pointer format.

Table 4- 37 Memory area encoding in the Pointer data:

| Hexadecimal code | Data type | Description |
|------------------|-----------|---------------------|
| b#16#81 | I | Input memory area |
| b#16#82 | Q | Output memory area |
| b#16#83 | M | Marker memory area |
| b#16#84 | DBX | Data block |
| b#16#85 | DIX | Instance data block |
| b#16#86 | L | Local data |
| b#16#87 | V | Previous local data |

4.4.9.2 "Any" pointer data type

The pointer data type ANY ("Any") points to the beginning of a data area and specifies its length. The ANY pointer uses 10 bytes in memory and can include the following information:

- Data type: Data type of the data elements
- Repeat factor: Number of data elements
- DB Number: Data block in which data elements are stored
- Storage area: Memory area of the CPU, in which the data elements are stored
- Start address: "Byte.Bit" starting address of the data

The following image shows the structure of the ANY pointer:

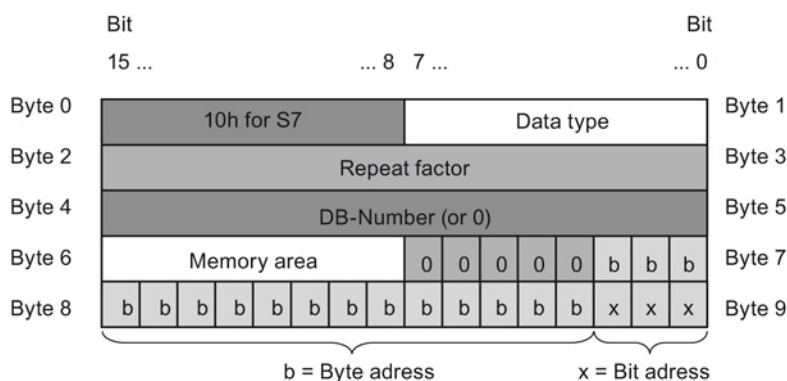

A pointer can not detect ANY structures. It can only be assigned to local variables.

Table 4- 38 Format and examples of the ANY pointer:

| Format | Entry example | Description |
|--|------------------------------------|--|
| P#Data_block.Memory_area Data_address Type Number | P#DB 11.DBX 20.0 INT 10 | 10 words in global DB 11 starting from DBB 20.0 |
| P#Memory_area Data_address Type Number | P#M 20.0 BYTE 10 P#I 1.0 BOOL 1 | 10 bytes starting from MB 20.0 Input I1.0 |

Table 4- 39 Data type encoding in the ANY pointer

| Hexadecimal code | Data type | Description |
|------------------|-----------|--------------------------------|
| b#16#00 | Null | Null pointer |
| b#16#01 | Bool | Bits |
| b#16#02 | Byte | Bytes, 8 Bits |
| b#16#03 | Char | 8-bit character |
| b#16#04 | Word | 16-bit-word |
| b#16#05 | Int | 16-bit-integer |
| b#16#37 | SInt | 8-bit-integer |
| b#16#35 | UInt | 16-bit unsigned integer |
| b#16#34 | USInt | 8-bit unsigned integer |
| b#16#06 | DWord | 32-bit double word |
| b#16#07 | DInt | 32-bit double integer |
| b#16#36 | UDInt | 32-bit-unsigned double integer |
| b#16#08 | Real | 32-Bit floating point |
| b#16#0B | Time | Time |
| b#16#13 | String | Character string |

Table 4- 40 Memory area encoding in the ANY pointer:

| Hexadecimal code | Memory area | Description |
|------------------|-------------|---------------------|
| b#16#81 | I | Input memory area |
| b#16#82 | Q | Output memory area |
| b#16#83 | M | Marker memory area |
| b#16#84 | DBX | Data block |
| b#16#85 | DIX | Instance data block |
| b#16#86 | L | Local data |
| b#16#87 | V | Previous local data |

4.4.9.3 "Variant" pointer data type

The data type Variant can point to variables of different data types or parameters. The Variant pointer can point to structures and individual structural components. The Variant pointer does not occupy any space in memory.

Table 4- 41 Properties of the Variant pointer

| Length (Byte) | Representation | Format | Example entry |
|---------------|----------------|----------------------------------|------------------------|
| 0 | Symbolic | Operand | MyTag |
| | | DB_name.Struct_name.element_name | MyDB.Struct1.pressure1 |
| | Absolute | Operand | %MW10 |
| | | DB_number.Operand Type Length | P#DB10.DBX10.0 INT 12 |

4.4.10 Accessing a "slice" of a tagged data type

PLC tags and data block tags can be accessed at the bit, byte, or word level depending on their size. The syntax for accessing such a data slice is as follows:

- "<PLC tag name>".xn (bit access)
- "<PLC tag name>".bn (byte access)
- "<PLC tag name>".wn (word access)
- "<Data block name>".<tag name>.xn (bit access)
- "<Data block name>".<tag name>.bn (byte access)
- "<Data block name>".<tag name>.wn (word access)

A double word-sized tag can be accessed by bits 0 - 31, bytes 0 - 3, or word 0 - 1. A word-sized tag can be accessed by bits 0 - 15, bytes 0 - 1, or word 0. A byte-sized tag can be accessed by bits 0 - 7, or byte 0. Bit, byte, and word slices can be used anywhere that bits, bytes, or words are expected operands.

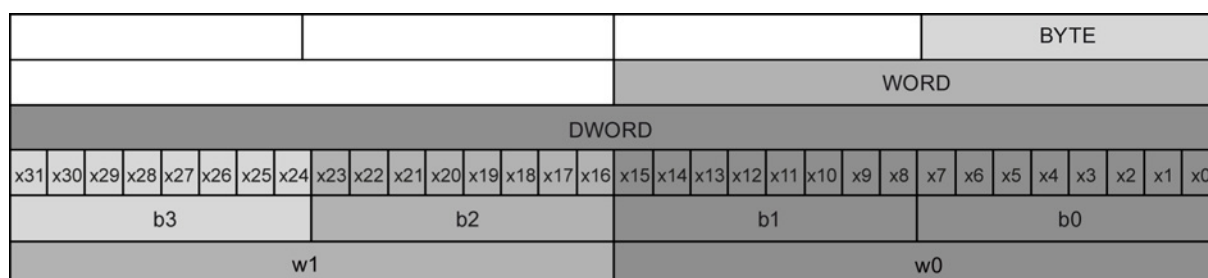

Note

Valid data types that can be accessed by slice are Byte, Char, Conn_Any, Date, DInt, DWord, Event_Any, Event_Att, Hw_Any, Hw_Device, HW_Interface, Hw_Io, Hw_Pwm, Hw_SubModule, Int, OB_Any, OB_Att, OB_Cyclic, OB_Delay, OB_WHINT, OB_PCYCLE, OB_STARTUP, OB_TIMEERROR, OB_Tod, Port, Rtm, SInt, Time, Time_Of_Day, UDInt, UInt, USInt, and Word. PLC Tags of type Real can be accessed by slice, but data block tags of type Real cannot.

Examples

In the PLC tag table, "DW" is a declared tag of type DWORD. The examples show bit, byte, and word slice access:

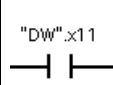
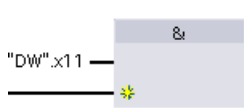
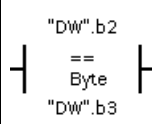
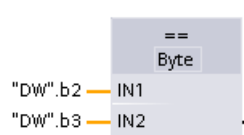
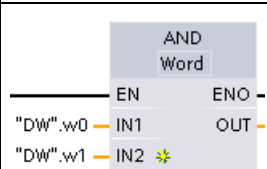
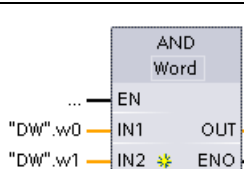
| | LAD | FBD | SCL |
|--------------------|---|--|--|
| Bit access |  |  | <pre>IF "DW".x11 THEN ... END_IF;</pre> |
| Byte access |  |  | <pre>IF "DW".b2 = "DW".b3 THEN ... END_IF;</pre> |
| Word access |  |  | <pre>out:= "DW".w0 AND "DW".w1;</pre> |

4.4.11 Accessing a tag with an AT overlay

The AT tag overlay allows you to access an already-declared tag of a standard access block with an overlaid declaration of a different data type. You can, for example, address the individual bits of a tag of a Byte, Word, or DWord data type with an Array of Bool.

Declaration

To overlay a parameter, declare an additional parameter directly after the parameter that is to be overlaid and select the data type "AT". The editor creates the overlay, and you can then choose the data type, struct, or array that you wish to use for the overlay.

Example

This example shows the input parameters of a standard-access FB. The byte tag B1 is overlaid with an array of Booleans:

| | | |
|---|-------|------------------------------|
| ■ | B1 | Byte |
| ▼ | AT | AT "B1" Array [0..7] of Bool |
| ■ | AT[0] | Bool |
| ■ | AT[1] | Bool |
| ■ | AT[2] | Bool |
| ■ | AT[3] | Bool |
| ■ | AT[4] | Bool |
| ■ | AT[5] | Bool |
| ■ | AT[6] | Bool |
| ■ | AT[7] | Bool |

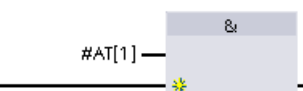
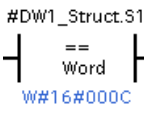
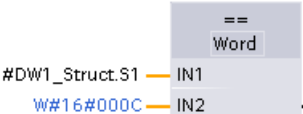

Table 4- 42 Overlay of a byte with a Boolean array

| | | | | | | | |
|-------|-------|-------|-------|-------|-------|-------|-------|
| 7 | 6 | 5 | 4 | 3 | 2 | 1 | 0 |
| AT[0] | AT[1] | AT[2] | AT[3] | AT[4] | AT[5] | AT[6] | AT[7] |

Another example is a DWord tag overlaid with a Struct:

| | |
|--------------|-----------------|
| ■ DW1 | DWord |
| ▼ DW1_Struct | AT "DW1" Struct |
| ■ S1 | Word |
| ■ S2 | Byte |
| ■ S3 | Byte |

The overlay types can be addressed directly in the program logic:

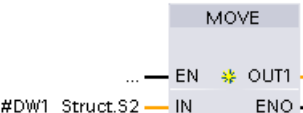
| LAD | FBD | SCL |
|---|---|---|
|  |  | <pre>IF #AT[1] THEN ... END_IF;</pre> |
|  |  | <pre>IF (#DW1_Struct.S1 = W#16#000C) THEN ... END_IF;</pre> |
|  |  | <pre>out1 := #DW1_Struct.S2;</pre> |

Rules

- Overlaying of tags is only possible in FB and FC blocks with standard access.
- You can overlay parameters for all block types and all declaration sections.
- An overlaid parameter can be used like any other block parameter.
- You cannot overlay parameters of type VARIANT.
- The size of the overlaying parameter must be less than or equal to the size of the overlaid parameter.
- The overlaying variable must be declared immediately after the variable that it overlays and identified with the keyword "AT".

4.5 Using a memory card

Note

The CPU supports only the pre-formatted SIMATIC memory cards (Page 978).

Before you copy any program to the formatted memory card, delete any previously saved program from the memory card.

Use the memory card either as a transfer card or as a program card. Any program that you copy to the memory card contains all of the code blocks and data blocks, any technology objects, and the device configuration. A copied program does **not** contain force values.

- Use a transfer card (Page 127) to copy a program to the internal load memory of the CPU without using STEP 7. After you insert the transfer card, the CPU first erases the user program and any force values from the internal load memory, and then copies the program from the transfer card to the internal load memory. When the transfer process is complete, you must remove the transfer card.

You can use an empty transfer card to access a password-protected CPU when the password has been lost or forgotten (Page 136). Inserting the empty transfer card deletes the password-protected program in the internal load memory of the CPU. You can then download a new program to the CPU.

- Use a program card (Page 130) as external load memory for the CPU. Inserting a program card in the CPU erases all of the CPU internal load memory (the user program and any force values). The CPU then executes the program in external load memory (the program card). Downloading to a CPU that has a program card updates only the external load memory (the program card).

Because the internal load memory of the CPU was erased when you inserted the program card, the program card **must** remain in the CPU. If you remove the program card, the CPU goes to STOP mode. (The error LED flashes to indicate that program card has been removed.)

The copied program on a memory card includes the code blocks, the data blocks, the technology objects, and the device configuration. The memory card does **not** contain any force values. The force values are not part of the program, but are stored in the load memory, whether the internal load memory of the CPU, or the external load memory (a program card). If a program card is inserted in the CPU, STEP 7 then applies the force values only to the external load memory on the program card.

You also use a memory card when downloading firmware updates (Page 133).

4.5.1 Inserting a memory card in the CPU

NOTICE

Protect memory card and receptacle from electrostatic discharge

Electrostatic discharge can damage the memory card or the receptacle on the CPU.

Make contact with a grounded conductive pad and/or wear a grounded wrist strap when you handle the memory card. Store the memory card in a conductive container.



Check that the memory card is not write-protected. Slide the protection switch away from the "Lock" position.

⚠ WARNING

Verify that the CPU is not running a process before inserting the memory card.

If you insert a memory card (whether configured as a program card, transfer card, or firmware update card) into a running CPU, the CPU goes immediately to STOP mode, which might cause process disruption that could result in death or severe personal injury.

Before inserting or removing a memory card, always ensure that the CPU is not actively controlling a machine or process. Always install an emergency stop circuit for your application or process.

Note

Do not insert V3.0 program transfer cards into S7-1200 V4.0 CPUs.

Version 3.0 program transfer cards are not compatible with version S7-1200 V4.0 CPUs. Inserting a memory card that contains a V3.0 program causes a CPU error.

If you do insert an invalid version program transfer card (Page 127), you should remove the card, and perform a STOP to RUN transition, a memory reset (MRES), or cycle power. After you recover the CPU from the error condition, you can download a valid V4.0 CPU program.

To transfer a V3.0 program to a V4.0 program, you must use the TIA Portal to Change Device in the Hardware Configuration.

Note

If you insert a memory card with the CPU in STOP mode, the diagnostic buffer displays a message that the memory card evaluation has been initiated. The CPU will evaluate the memory card the next time you either change the CPU to RUN mode, reset the CPU memory with an MRES, or power-cycle the CPU.

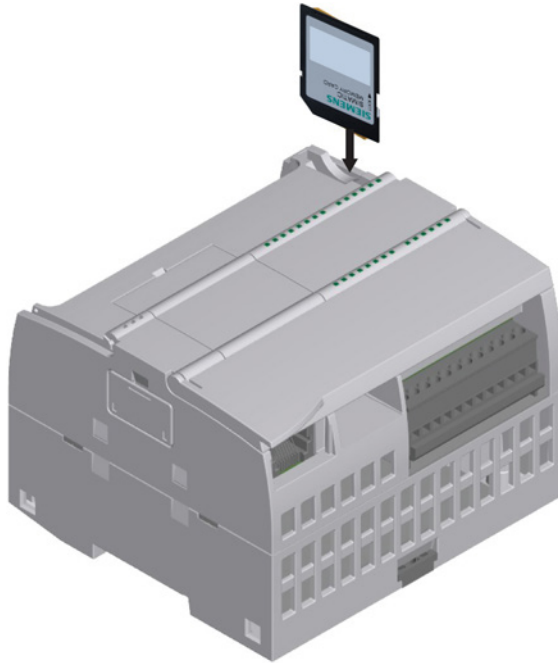

To insert a memory card, open the top CPU door and insert the memory card in the slot. A push-push type connector allows for easy insertion and removal. The memory card is keyed for proper installation.

4.5.2 Configuring the startup parameter of the CPU before copying the project to the memory card

When you copy a program to a transfer card or a program card, the program includes the startup parameter for the CPU. Before copying the program to the memory card, always ensure that you have configured the operating mode for the CPU following a power-cycle. Select whether the CPU starts in STOP mode, RUN mode, or in the previous mode (prior to the power cycle).

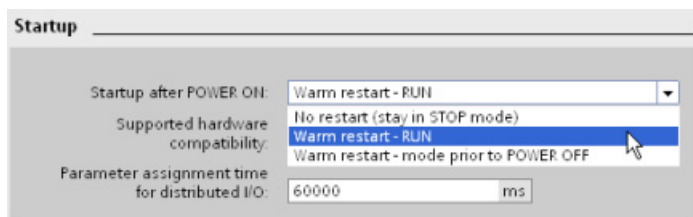

4.5.3 Transfer card

NOTICE

Protect memory card and receptacle from electrostatic discharge

Electrostatic discharge can damage the memory card or the receptacle on the CPU.

Make contact with a grounded conductive pad and/or wear a grounded wrist strap whenever you handle the memory card. Store the memory card in a conductive container.

Creating a transfer card

Always remember to configure the startup parameter of the CPU (Page 127) before copying a program to the transfer card. To create a transfer card, follow these steps:

1. Insert a blank SIMATIC memory card that is not write-protected into an SD card reader/writer attached to your computer. (If the card is write-protected, slide the protection switch away from the "Lock" position.)

If you are reusing a SIMATIC memory card that contains a user program or a firmware update, you **must** delete the program files before reusing the card. Use Windows Explorer to display the contents of the memory card and delete the "S7_JOB.S7S" file and also delete any existing "Data Logs" folders and directory folder (such as "SIMATIC.S7S" or "FWUPDATE.S7S").

NOTICE

Do NOT delete the hidden files "__LOG__" and "crdinfo.bin" from the memory card.

The "__LOG__" and "crdinfo.bin" files are required for the memory card. If you delete these files, you cannot use the memory card with the CPU.

2. In the Project tree (Project view), expand the "SIMATIC Card Reader" folder and select your card reader.
3. Display the "Memory card" dialog by right-clicking the drive letter corresponding to the memory card in the card reader and selecting "Properties" from the context menu.
4. In the "Memory card" dialog, select "Transfer" from the "Card type" drop-down menu.

At this point, STEP 7 creates the empty transfer card. If you are creating an empty transfer card, such as to recover from a lost CPU password (Page 136), remove the transfer card from the card reader.

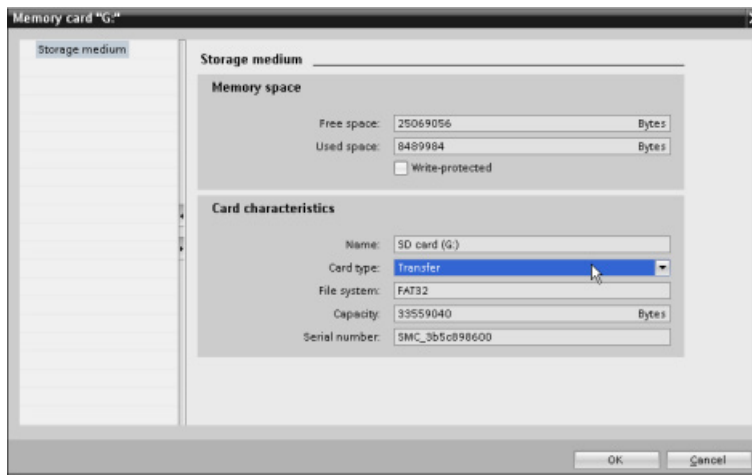

5. Add the program by selecting the CPU device (such as PLC_1 [CPU 1214 DC/DC/DC]) in the Project tree and dragging the CPU device to the memory card. (Another method is to copy the CPU device and paste it to the memory card.) Copying the CPU device to the memory card opens the "Load preview" dialog.

6. In the "Load preview" dialog, click the "Load" button to copy the CPU device to the memory card.
7. When the dialog displays a message that the CPU device (program) has been loaded without errors, click the "Finish" button.

Using a transfer card

WARNING

Verify that the CPU is not actively running a process before inserting the memory card.

Inserting a memory card will cause the CPU to go to STOP mode, which could affect the operation of an online process or machine. Unexpected operation of a process or machine could result in death or injury to personnel and/or property damage.

Before inserting a transfer card, always ensure that the CPU is in STOP mode and your process is in a safe state.

Note

Do not insert V3.0 program transfer cards into S7-1200 V4.0 CPUs.

Version 3.0 program transfer cards are not compatible with version S7-1200 V4.0 CPUs. Inserting a memory card that contains a V3.0 program causes a CPU error.

If you do insert an invalid version program transfer card, then remove the card, perform a STOP to RUN transition, a memory reset (MRES), or cycle power. After you recover the CPU from the error condition, you can download a valid V4.0 CPU program

To transfer the program to a CPU, follow these steps:

1. Insert the transfer card into the CPU (Page 125). If the CPU is in RUN, the CPU will go to STOP mode. The maintenance (MAINT) LED flashes to indicate that the memory card needs to be evaluated.
2. Power-cycle the CPU to evaluate the memory card. Alternative methods for rebooting the CPU are to perform either a STOP-to-RUN transition or a memory reset (MRES) from STEP 7.
3. After the rebooting and evaluating the memory card, the CPU copies the program to the internal load memory of the CPU.

The RUN/STOP LED alternately flashes green and yellow to indicate that the program is being copied. When the RUN/STOP LED turns on (solid yellow) and the MAINT LED flashes, the copy process has finished. You can then remove the memory card.

4. Reboot the CPU (either by restoring power or by the alternative methods for rebooting) to evaluate the new program that was transferred to internal load memory.

The CPU then goes to the start-up mode (RUN or STOP) that you configured for the project.

Note

You must remove the transfer card before setting the CPU to RUN mode.

4.5.4 Program card

| |
|---|
| NOTICE |
| Electrostatic discharge can damage the memory card or the receptacle on the CPU. Make contact with a grounded conductive pad and/or wear a grounded wrist strap when you handle the memory card. Store the memory card in a conductive container. |



Check that the memory card is not write-protected. Slide the protection switch away from the "Lock" position.

Before you copy any program elements to the program card, delete any previously saved programs from the memory card.

Creating a program card

When used as a program card, the memory card is the external load memory of the CPU. If you remove the program card, the internal load memory of the CPU is empty.

Note

If you insert a blank memory card into the CPU and perform a memory card evaluation by either power cycling the CPU, performing a STOP to RUN transition, or performing a memory reset (MRES), the program and force values in internal load memory of the CPU are copied to the memory card. (The memory card is now a program card.) After the copy has been completed, the program in internal load memory of the CPU is then erased. The CPU then goes to the configured startup mode (RUN or STOP).

Always remember to configure the startup parameter of the CPU (Page 127) before copying a project to the program card. To create a program card, follow these steps:

1. Insert a blank SIMATIC memory card that is not write-protected into an SD card reader/writer attached to your computer. (If the card is write-protected, slide the protection switch away from the "Lock" position.)

If you are reusing a SIMATIC memory card that contains a user program or a firmware update, you **must** delete the program files before reusing the card. Use Windows Explorer to display the contents of the memory card and delete the "S7_JOB.S7S" file and also delete any existing "Data Logs" folders and any directory folder (such as "SIMATIC.S7S" or "FWUPDATE.S7S").

NOTICE

Do NOT delete the hidden files "__LOG__" and "crdinfo.bin" from the memory card.

The "__LOG__" and "crdinfo.bin" files are required for the memory card. If you delete these files, you cannot use the memory card with the CPU.

2. In the Project tree (Project view), expand the "SIMATIC Card Reader" folder and select your card reader.
3. Display the "Memory card" dialog by right-clicking the drive letter corresponding to the memory card in the card reader and selecting "Properties" from the context menu.
4. In the "Memory card" dialog, select "Program" from the drop-down menu.

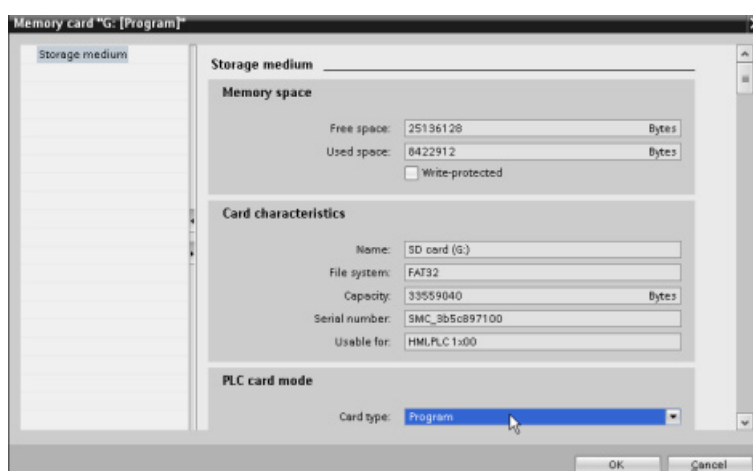

5. Add the program by selecting the CPU device (such as PLC_1 [CPU 1214 DC/DC/DC]) in the Project tree and dragging the CPU device to the memory card. (Another method is to copy the CPU device and paste it to the memory card.) Copying the CPU device to the memory card opens the "Load preview" dialog.
6. In the "Load preview" dialog, click the "Load" button to copy the CPU device to the memory card.
7. When the dialog displays a message that the CPU device (program) has been loaded without errors, click the "Finish" button.

Using a program card as the load memory for your CPU

| |
|--|
|  WARNING |
| Risks associated with inserting a program card |
| Verify that the CPU is not actively running a process before inserting the memory card. |
| Inserting a memory card will cause the CPU to go to STOP mode, which could affect the operation of an online process or machine. Unexpected operation of a process or machine could result in death or injury to personnel and/or property damage. |
| Before inserting a memory card, always ensure that the CPU is offline and in a safe state. |

To use a program card with your CPU, follow these steps:

1. Insert the program card into the CPU. If the CPU is in RUN mode, the CPU goes to STOP mode. The maintenance (MAINT) LED flashes to indicate that the memory card needs to be evaluated.
2. Power-cycle the CPU to evaluate the memory card. Alternative methods for rebooting the CPU are to perform either a STOP-to-RUN transition or a memory reset (MRES) from STEP 7.
3. After the CPU reboots and evaluates the program card, the CPU erases the internal load memory of the CPU.

The CPU then goes to the start-up mode (RUN or STOP) that you configured for the CPU.

The program card must remain in the CPU. Removing the program card leaves the CPU with no program in internal load memory.

| |
|--|
|  WARNING |
| Risks associated with removing a program card |
| If you remove the program card, the CPU loses its external load memory and generates an error. The CPU goes to STOP mode and flashes the error LED. |
| Control devices can fail in an unsafe condition, resulting in unexpected operation of controlled equipment. Such unexpected operations could result in death or serious injury to personnel, and/or damage to equipment. |
| Do not remove the program card without understanding that you are removing the program from CPU. |

4.5.5 Firmware update

You can use a memory card for performing a firmware update. Alternative methods include using the module information page (Page 616) of the Web server to perform a firmware update, or using the online and diagnostic functions of STEP 7 to perform a firmware update (Page 791). This chapter explains the method that uses a memory card.

NOTICE

Protect memory card and receptacle from electrostatic discharge

Electrostatic discharge can damage the memory card or the receptacle on the CPU.

Make contact with a grounded conductive pad and/or wear a grounded wrist strap whenever you handle the memory card. Store the memory card in a conductive container.

You use a memory card when downloading firmware updates from customer support (<http://www.siemens.com/automation/>). From this Web site, navigate to **Automation Technology > Automation Systems > SIMATIC Industrial Automation Systems > PLC > Modular controllers SIMATIC S7 > SIMATIC S7-1200**. From there continue navigating to the specific type of module that you need to update. Under "Support", click the link for "Software Downloads" to proceed.

Alternatively, you can access the S7-1200 downloads Web page (<http://support.automation.siemens.com/WW/view/en/34612486/133100>) directly.

Note

You cannot update an S7-1200 CPU V3.0 or earlier to S7-1200 V4.0 by firmware update.

NOTICE

Do not use the Windows formatter utility or any other formatting utility to reformat the memory card.

If a Siemens memory card is reformatted using the Microsoft Windows formatter utility, then the memory card will no longer be usable by a S7-1200 CPU.

To download the firmware update to your memory card, follow these steps:

1. Insert a blank SIMATIC memory card that is not write-protected into an SD card reader/writer attached to your computer. (If the card is write-protected, slide the protection switch away from the "Lock" position.)

You can reuse a SIMATIC memory card that contains a user program or another firmware update, but you must delete some of the files on the memory card.

To reuse a memory card, you **must** delete the "S7_JOB.S7S" file and any existing "Data Logs" folders or any folder (such as "SIMATIC.S7S" or "FWUPDATE.S7S") before downloading the firmware update. Use Windows Explorer to display the contents of the memory card and to delete the file and folders.

NOTICE

Do NOT delete the hidden files "__LOG__" and "crdinfo.bin" from the memory card.

The "__LOG__" and "crdinfo.bin" files are required for the memory card. If you delete these files, you cannot use the memory card with the CPU.

2. Select the self-extracting file (.exe) for the firmware update that corresponds to your module, and download it to your computer. Double-click the update file, set the file destination path to be the root directory of the SIMATIC memory card, and start the extraction process. After the extraction is complete, the root directory (folder) of the memory card will contain a "FWUPDATE.S7S" directory and the "S7_JOB.S7S" file.
3. Safely eject the card from the card reader/writer.

To install the firmware update, follow these steps:

 **WARNING**

Verify that the CPU is not actively running a process before installing the firmware update.

Installing the firmware update will cause the CPU to go to STOP mode, which could affect the operation of an online process or machine. Unexpected operation of a process or machine could result in death or injury to personnel and/or property damage.

Before inserting the memory card, always ensure that the CPU is offline and in a safe state.

1. Insert the memory card into the CPU. If the CPU is in RUN mode, the CPU then goes to STOP mode. The maintenance (MAINT) LED flashes to indicate that the memory card needs to be evaluated.
2. Power-cycle the CPU to start the firmware update. Alternative methods for rebooting the CPU are to perform either a STOP-to-RUN transition or a memory reset (MRES) from STEP 7.

Note

To complete the firmware upgrade for the module, you must ensure that the external 24 VDC power to the module remains on.

After the CPU reboots, the firmware update starts. The RUN/STOP LED alternately flashes green and yellow to indicate that the update is being copied. When the RUN/STOP LED turns on (solid yellow) and the MAINT LED flashes, the copy process has finished. You must then remove the memory card.

3. After removing the memory card, reboot the CPU again (either by restoring power or by the alternative methods for rebooting) to load the new firmware.

The user program and hardware configuration are not affected by the firmware update. When the CPU is powered up, the CPU enters the configured start-up state. (If the startup mode for your CPU was configured to "Warm restart - mode before POWER OFF", the CPU will be in STOP mode because the last state of the CPU was STOP.)

Note**Updating multiple modules connected to CPU**

If your hardware configuration contains multiple modules that correspond to a single firmware update file on the memory card, the CPU applies the updates to all applicable modules (CM, SM, and SB) in configuration order, that is, by increasing order of the module position in Device Configuration in STEP 7.

If you have downloaded multiple firmware updates to the memory card for multiple modules, the CPU applies the updates in the order in which you downloaded them to the memory card.

4.6 Recovery from a lost password

If you have lost the password for a password-protected CPU, use an empty transfer card to delete the password-protected program. The empty transfer card erases the internal load memory of the CPU. You can then download a new user program from STEP 7 to the CPU.

For information about the creation and use of an empty transfer card, see the section of transfer cards (Page 127).

 **WARNING**

Verify that the CPU is not actively running a process before inserting the memory card

If you insert a transfer card in a running CPU, the CPU goes to STOP. Control devices can fail in an unsafe condition, resulting in unexpected operation of controlled equipment. Such unexpected operations could result in death or serious injury to personnel, and/or damage to equipment.

Before inserting a transfer card, always ensure that the CPU is in STOP mode and your process is in a safe state.

You must remove the transfer card before setting the CPU to RUN mode.

Device configuration

You create the device configuration for your PLC by adding a CPU and additional modules to your project.

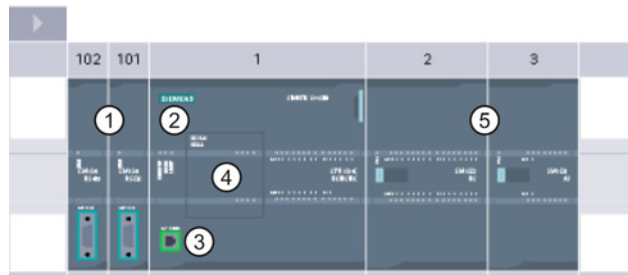

- ① Communication module (CM) or communication processor (CP): Up to 3, inserted in slots 101, 102, and 103
- ② CPU: Slot 1
- ③ Ethernet port of CPU
- ④ Signal board (SB), communication board (CB) or battery board (BB): up to 1, inserted in the CPU
- ⑤ Signal module (SM) for digital or analog I/O: up to 8, inserted in slots 2 through 9 (CPU 1214C, CPU 1215C and CPU 1217C allow 8, CPU 1212C allows 2, CPU 1211C does not allow any)

To create the device configuration, add a device to your project.

- In the Portal view, select "Devices & Networks" and click "Add new device".
- In the Project view, under the project name, double-click "Add new device".

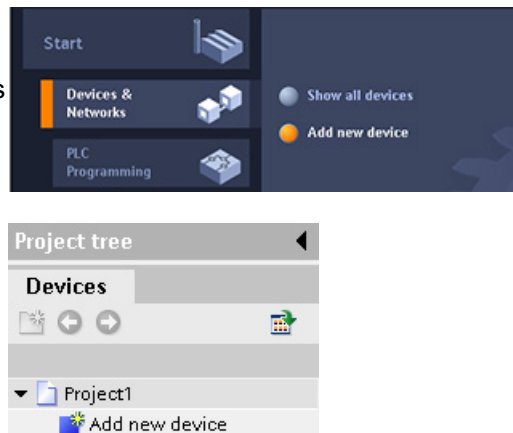

5.1 Inserting a CPU

You create your device configuration by inserting a CPU into your project. Be sure you insert the correct model and firmware version from the list. Selecting the CPU from the "Add new device" dialog creates the rack and CPU.

"Add new device" dialog

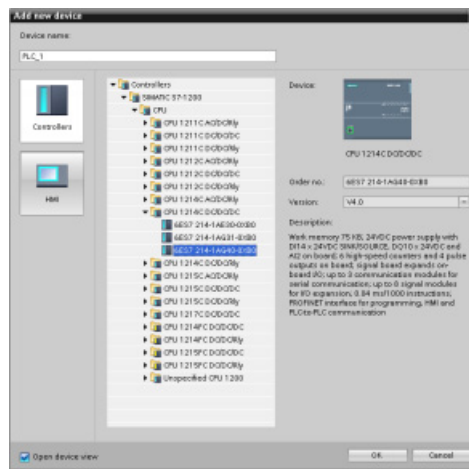

Device view of the hardware configuration

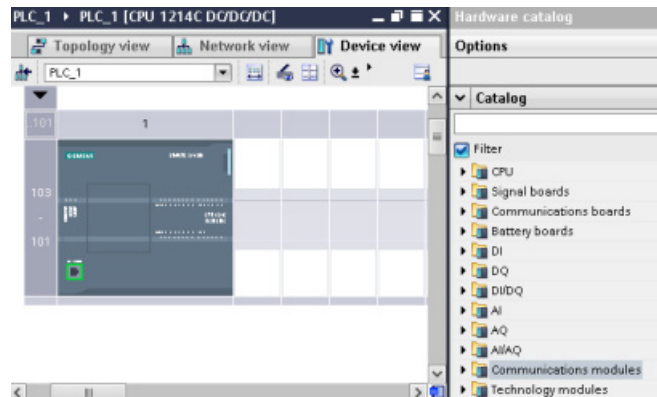

Selecting the CPU in the Device view displays the CPU properties in the inspector window.

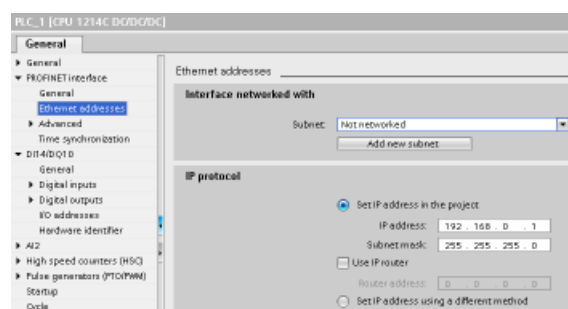

Note

The CPU does not have a pre-configured IP address. You must manually assign an IP address for the CPU during the device configuration. If your CPU is connected to a router on the network, you also enter the IP address for a router.

5.2 Detecting the configuration for an unspecified CPU

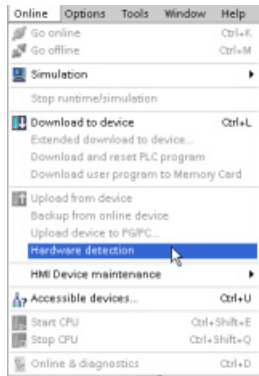

If you are connected to a CPU, you can upload the configuration of that CPU, including any modules, to your project. Simply create a new project and select the "unspecified CPU" instead of selecting a specific CPU. (You can also skip the device configuration entirely by selecting the "Create a PLC program" from the "First steps". STEP 7 then automatically creates an unspecified CPU.)

From the program editor, you select the "Hardware detection" command from the "Online" menu.

From the device configuration editor, you select the option for detecting the configuration of the connected device.

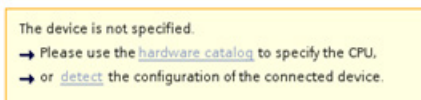
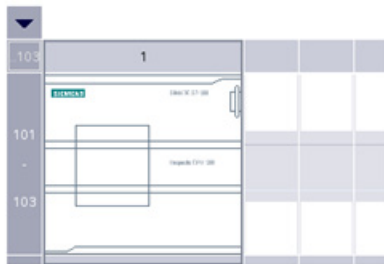

After you select the CPU from the online dialog and click the Load button, STEP 7 uploads the hardware configuration from the CPU, including any modules (SM, SB, or CM). You can then configure the parameters for the CPU and the modules.

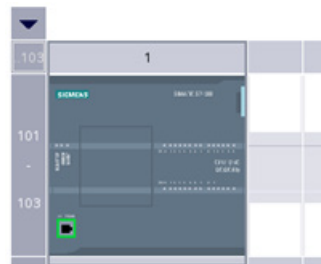
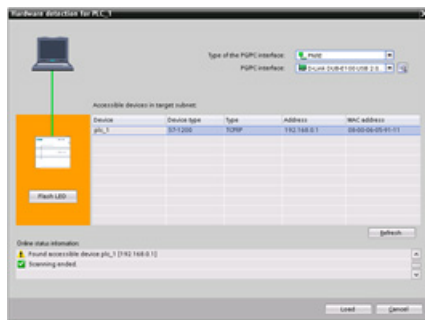





5.3 Adding modules to the configuration

Use the hardware catalog to add modules to the CPU:

- Signal module (SM) provides additional digital or analog I/O points. These modules are connected to the right side of the CPU.
- Signal board (SB) provides just a few additional I/O points for the CPU. The SB is installed on the front of the CPU.
- Battery Board 1297 (BB) provides long-term backup of the realtime clock. The BB is installed on the front of the CPU.
- Communication board (CB) provides an additional communication port (such as RS485). The CB is installed on the front of the CPU.
- Communication module (CM) and communication processor (CP) provide an additional communication port, such as for PROFIBUS or GPRS. These modules are connected to the left side of the CPU.

To insert a module into the device configuration, select the module in the hardware catalog and either double-click or drag the module to the highlighted slot. You must add the modules to the device configuration and download the hardware configuration to the CPU for the modules to be functional.

Table 5- 1 Adding a module to the device configuration

| Module | Select the module | Insert the module | Result |
|--------------|---|--|---|
| SM |  |  |  |
| SB, BB or CB |  |  |  |
| CM or CP |  |  |  |

5.4 Changing a device

You can change the device type of a configured CPU or module. From Device configuration, right-click the device and select "Change device" from the context menu. From the dialog, navigate to and select the CPU or module that you want to replace. The Change device dialog shows you compatibility information between the two devices.

Note

Device exchange: replacing a V3.0 CPU with a V4.0 CPU

You can open a STEP 7 V12 project in STEP 7 V13 and replace V3.0 CPUs with V4.0 CPUs. You cannot replace CPUs that are from versions prior to V3.0. When you replace a V3.0 CPU with a V4.0 CPU, consider the differences (Page 995) in features and behavior between the two versions, and actions you must take.

If you have a project for a CPU version older than V3.0, you can upgrade that project first to V3.0 and then upgrade the V3.0 project to V4.0.

5.5 Configuring the operation of the CPU

5.5.1 Overview

To configure the operational parameters for the CPU, select the CPU in the Device view (blue outline around whole CPU), and use the "Properties" tab of the inspector window.

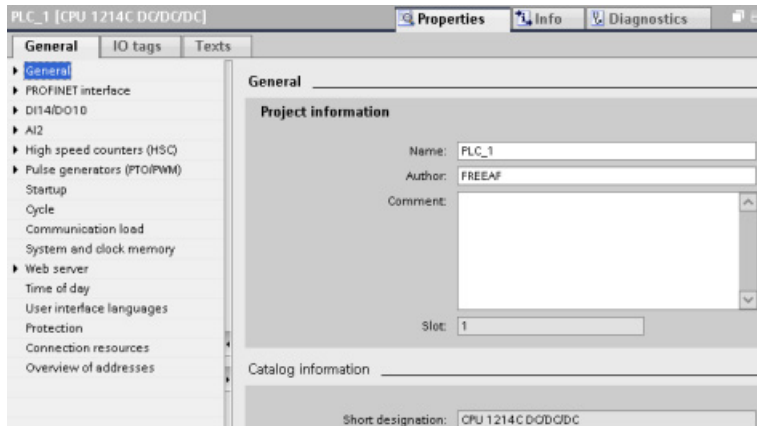

Table 5-2 CPU properties

| Property | Description |
|--|---|
| PROFINET interface | Sets the IP address for the CPU and time synchronization |
| DI, DO, and AI | Configures the behavior of the local (on-board) digital and analog I/O (for example, digital input filter times and digital output reaction to a CPU stop). |
| High-speed counters (Page 409) and pulse generators (Page 365) | Enables and configures the high-speed counters (HSC) and the pulse generators used for pulse-train operations (PTO) and pulse-width modulation (PWM) When you configure the outputs of the CPU or signal board as pulse generators (for use with the PWM or motion control instructions), the corresponding output addresses are removed from the Q memory and cannot be used for other purposes in your user program. If your user program writes a value to an output used as a pulse generator, the CPU does not write that value to the physical output. |
| Startup (Page 81) | <p>Startup after POWER ON: Selects the behavior of the CPU following an off-to-on transition, such as to start in STOP mode or to go to RUN mode after a warm restart</p> <p>Supported hardware compatibility: Configures the substitution strategy for all system components (SM, SB, CM, CP and CPU):</p> <ul style="list-style-type: none"> • Allow acceptable substitute • Allow any substitute (default) <p>Each module internally contains substitution compatibility requirements based on the number of I/O, electrical compatibility, and other corresponding points of comparison. For example, a 16-channel SM could be an acceptable substitute for an 8-channel SM, but an 8-channel SM could not be an acceptable substitute for a 16-channel SM. If you select "Allow acceptable substitute", STEP 7 enforces the substitution rules; otherwise, STEP 7 allows any substitution.</p> <p>Parameter assignment time for distributed I/O: Configures a maximum amount of time (default: 60000 ms) for the distributed I/O to be brought online. (The CMs and CPs receive power and communication parameters from the CPU during startup. This assignment time allows time for the I/O connected to the CM or CP to be brought online.)</p> <p>The CPU goes to RUN as soon as the distributed I/O is online, regardless of the assignment time. If the distributed I/O has not been brought online within this time, the CPU still goes to RUN--without the distributed I/O.</p> <p>Note: If your configuration uses a CM 1243-5 (PROFIBUS master), do not set this parameter below 15 seconds (15000 ms) to ensure that the module can be brought online.</p> |
| Cycle (Page 97) | Defines a maximum cycle time or a fixed minimum cycle time |
| Communication load | Allocates a percentage of the CPU time to be dedicated to communication tasks |
| System and clock memory (Page 101) | Enables a byte for "system memory" functions and enables a byte for "clock memory" functions (where each bit toggles on and off at a predefined frequency). |
| Web server (Page 601) | Enables and configures the Web server feature. |
| Time of day | Selects the time zone and configures daylight saving time |
| User interface languages | Selects a language for Web server and CPU display corresponding to the project language. For up to two project languages, you can assign a corresponding user interface language for Web server and CPU display. |
| Protection (Page 190) | Sets the read/write protection and passwords for accessing the CPU |
| Connection resources (Page 511) | Provides a summary of the communication connection resources that are available for the CPU and the number of connection resources that have been configured. |
| Overview of addresses | Provides a summary of the I/O addresses that have been configured for the CPU. |

5.5.2 Configuring digital input filter times

The digital input filters protect your program from responding to unwanted fast changes in the input signals, as may result from switch contact bounce or electrical noise. The default filter time of 6.4 ms blocks unwanted transitions from typical mechanical contacts. Different points in your application can require shorter filter times to detect and respond to inputs from fast sensors, or longer filter times to block slow contact bounce or longer impulse noise.

An input filter time of 6.4 ms means that a single signal change, from '0' to '1' or from '1' to '0', must continue for approximately 6.4 ms to be detected, and a single high or low pulse shorter than approximately 6.4 ms is not detected. If an input signal switches between '0' and '1' more rapidly than the filter time, the input point value can change in the user program when the accumulated duration of new value pulses over old value pulses exceeds the filter time.

The digital input filter works this way:

- When a "1" is input, it counts up, stopping at the filter time. The image register point changes from "0" to "1" when the count reaches the filter time.
- When a "0" is input, it counts down, stopping at "0". The image register point changes from "1" to "0" when the count reaches "0".
- If the input is changing back and forth, the counter will count up some and count down some. The image register will change when the net accumulation of counts reaches either the filter time or "0".
- A rapidly, changing signal with more "0's" than "1's" will eventually go to "0", and if there are more "1's" than "0's", the image register will eventually change to "1".

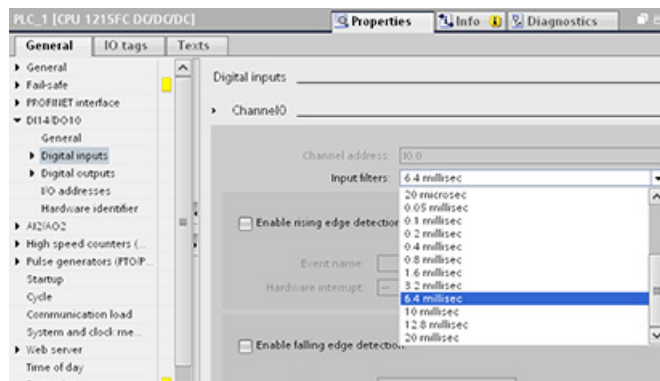

Each input point has a single filter configuration that applies to all uses: process inputs, interrupts, pulse catch, and HSC inputs. To configure input filter times, select "Digital Inputs".

The default filter time for the digital inputs is 6.4 ms. You can choose any of the following filter time values:

- 0.1 us
- 0.2 us
- 0.4 us
- 0.8 us
- 1.6 us
- 3.2 us
- 6.4 us
- 10.0 us
- 12.8 us
- 20.0 us
- 0.05 ms
- 0.1 ms
- 0.2 ms
- 0.4 ms
- 0.8 ms
- 1.6 ms
- 3.2 ms
- 6.4 ms
- 10.0 ms
- 12.8 ms
- 20.0 ms

 **WARNING**

Risks with changes to filter time for digital input channel

If the filter time for a digital input channel is changed from a previous setting, a new "0" level input value may need to be presented for up to 20.0 ms accumulated duration before the filter becomes fully responsive to new inputs. During this time, short "0" pulse events of duration less than 20.0 ms may not be detected or counted.

This changing of filter times can result in unexpected machine or process operation, which may cause death or serious injury to personnel, and/or damage to equipment.

To ensure that a new filter time goes immediately into effect, a power cycle of the CPU must be applied.

5.5.3 Pulse catch

The S7-1200 CPU provides a pulse catch feature for digital input points. The pulse catch feature allows you to capture high-going pulses or low-going pulses that are of such a short duration that they would not always be seen when the CPU reads the digital inputs at the beginning of the scan cycle.

When pulse catch is enabled for an input, a change in state of the input is latched and held until the next input cycle update. This ensures that a pulse which lasts for a short period of time will be caught and held until the CPU reads the inputs.

The figure below shows the basic operation of the S7-1200 CPU with and without pulse catch enabled:

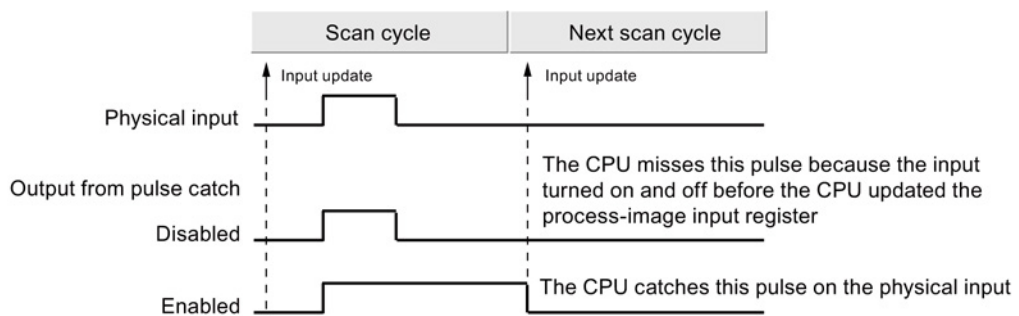

Because the pulse catch function operates on the input after it passes through the input filter, you must adjust the input filter time so that the pulse is not removed by the filter. The figure below shows a block diagram of the digital input circuit:

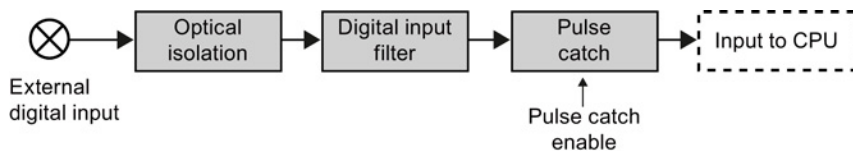

The figure below shows the response of an enabled pulse catch function to various input conditions. If you have more than one pulse in a given scan, only the first pulse is read. If you have multiple pulses in a given scan, you should use the rising/falling edge interrupt events:

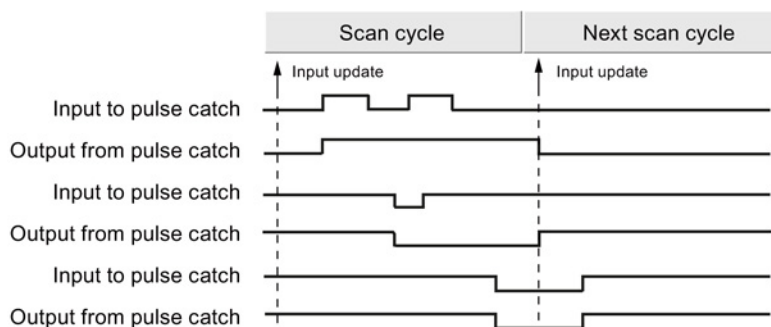

5.6 Configuring the parameters of the modules

To configure the operational parameters for the modules, select the module in the Device view and use the "Properties" tab of the inspector window to configure the parameters for the module.

Configuring a signal module (SM) or a signal board (SB)

The device configuration for signal modules and signal boards provides the means to configure the following:

- Digital I/O: You can configure inputs for rising-edge detection or falling-edge detection (associating each with an event and hardware interrupt) or for "pulse catch" (to stay on after a momentary pulse) through the next update of the input process image. Outputs can use a freeze or substitute value.
- Analog I/O: For individual inputs, configure parameters, such as measurement type (voltage or current), range and smoothing, and to enable underflow or overflow diagnostics. Analog outputs provide parameters such as output type (voltage or current) and for diagnostics, such as short circuit (for voltage outputs) or upper/lower limit diagnostics. You do not configure ranges of analog inputs and outputs in engineering units on the Properties dialog. You must handle this in your program logic as described in the topic "Processing of analog values (Page 110)".
- I/O addresses: You configure the start address for the set of inputs and outputs of the module. You can also assign the inputs and outputs to a process image partition (PIP0, PIP1, PIP2, PIP3, PIP4) or to automatically update, or to use no process image partition. See "Execution of the user program" (Page 77) for an explanation of the process image and process image partitions.

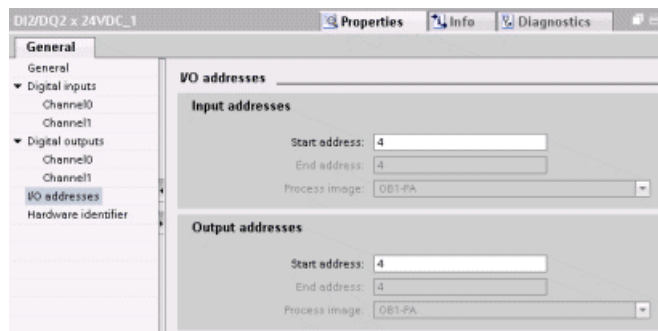

Configuring a communication interface (CM, CP or CB)

Depending on the type of communication interface, you configure the parameters for the network.

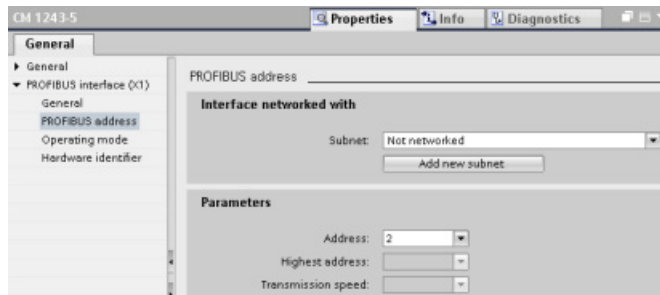

5.7 Configuring the CPU for communication

5.7.1 Creating a network connection

Use the "Network view" of Device configuration to create the network connections between the devices in your project. After creating the network connection, use the "Properties" tab of the inspector window to configure the parameters of the network.

Table 5- 3 Creating a network connection

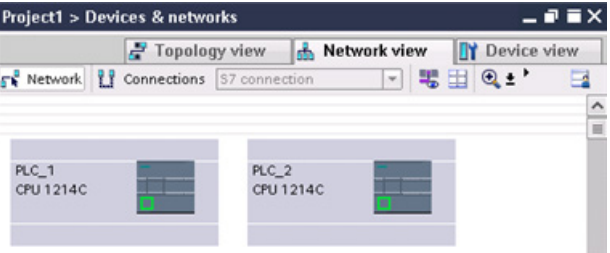
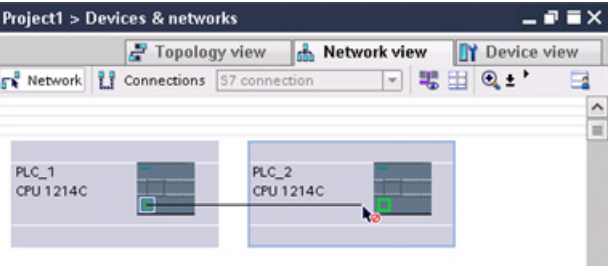
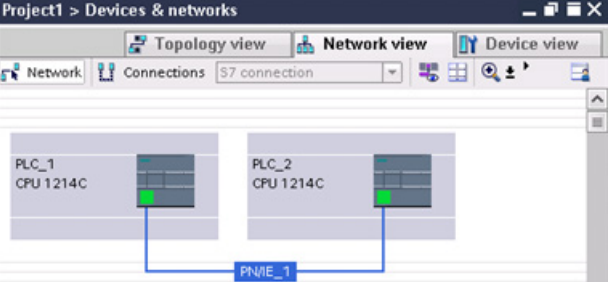
| Action | Result |
|---|--|
| Select "Network view" to display the devices to be connected. |  |
| Select the port on one device and drag the connection to the port on the second device. |  |
| Release the mouse button to create the network connection. |  |

5.7.2 Configuring the Local/Partner connection path

After inserting a TSEND_C, TRCV_C or TCON instruction into the user program, the inspector window displays the properties of the connection whenever you have selected any part of the instruction. Specify the communication parameters in the "Configuration" tab of the "Properties" for the communication instruction.

Table 5- 4 Configuring the connection path (using the properties of the instruction)

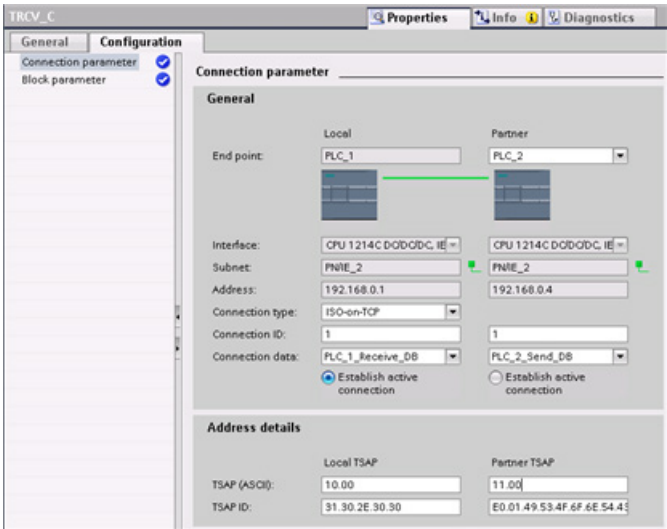
| TCP, ISO-on-TCP, and UDP | Connection properties |
|---|---|
| <p>For the TCP, ISO-on-TCP, and UDP Ethernet protocols, use the "Properties" of the instruction (TSEND_C, TRCV_C, or TCON) to configure the "Local/Partner" connections.</p> <p>The illustration shows the "Connection properties" of the "Configuration tab" for an ISO-on-TCP connection.</p> |  |

Note

When you configure the connection properties for one CPU, STEP 7 allows you either to select a specific connection DB in the partner CPU (if one exists), or to create the connection DB for the partner CPU. The partner CPU must already have been created for the project and cannot be an "unspecified" CPU.

You must still insert a TSEND_C, TRCV_C or TCON instruction into the user program of the partner CPU. When you insert the instruction, select the connection DB that was created by the configuration.

Table 5- 5 Configuring the connection path for S7 communication (Device configuration)

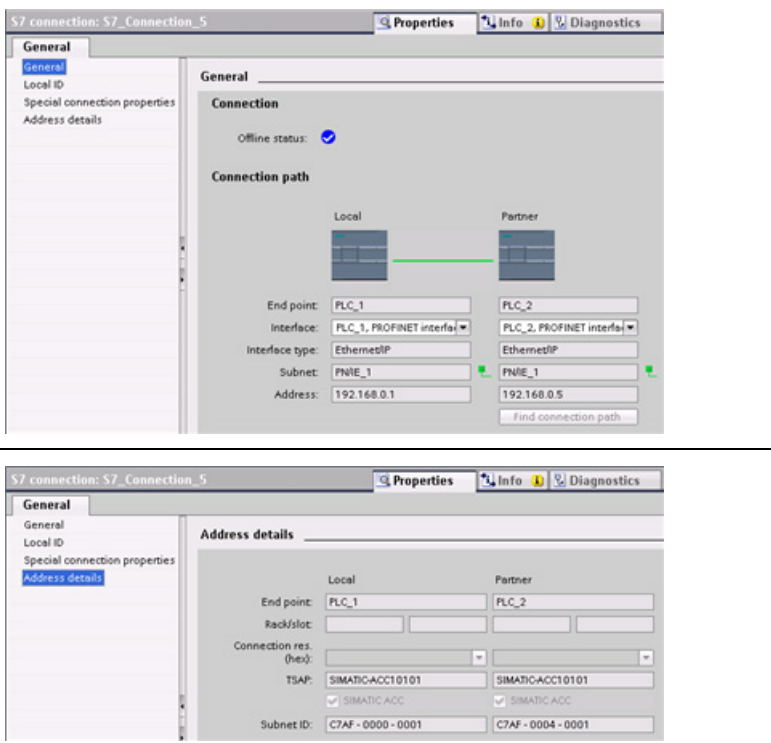
| S7 communication (GET and PUT) | Connection properties |
|--|---|
| <p>For S7 communication, use the "Devices & networks" editor of the network to configure the Local/Partner connections. You can click the "Highlighted: Connection" button to access the "Properties".</p> <p>The "General" tab provides several properties:</p> <ul style="list-style-type: none"> • "General" (shown) • "Local ID" • "Special connection properties" • "Address details" (shown) |  <p>The top screenshot displays the 'Connection' configuration window. It includes a 'General' tab and a 'Connection' section. The 'Offline status' is checked. The 'Connection path' section shows a diagram with 'Local' and 'Partner' PLCs connected by a green line. Below the diagram are input fields for 'End point', 'Interface', 'Interface type', 'Subnet', and 'Address' for both PLCs. The bottom screenshot displays the 'Address details' configuration window. It includes a 'General' tab and an 'Address details' section. It shows input fields for 'End point', 'Rack/slot', 'Connection res. (hex)', 'TSAP', 'SIMATIC ACC', and 'Subnet ID' for both 'Local' and 'Partner' PLCs.</p> |

Refer to "Protocols" (Page 517) in the "PROFINET" section or to "Creating an S7 connection" (Page 591) in the "S7 communication" section for more information and a list of available communication instructions.

Table 5- 6 Parameters for the multiple CPU connection

| Parameter | | Definition |
|-----------------|----------------------------------|---|
| Address | | Assigned IP addresses |
| General | End point | Name assigned to the partner (receiving) CPU |
| | Interface | Name assigned to the interfaces |
| | Subnet | Name assigned to the subnets |
| | Interface type | <i>S7 communication only.</i> Type of interface |
| | Connection type | Type of Ethernet protocol |
| | Connection ID | ID number |
| | Connection data | Local and Partner CPU data storage location |
| | Establish active connection | Radio button to select Local or Partner CPU as the active connection |
| Address details | End point | <i>S7 communication only.</i> Name assigned to the partner (receiving) CPU |
| | Rack/slot | <i>S7 communication only.</i> Rack and slot location |
| | Connection resource | <i>S7 communication only.</i> Component of the TSAP used when configuring an S7 connection with an S7-300 or S7-400 CPU |
| | Port (decimal): | TCP and UPD: Partner CPU port in decimal format |
| | TSAP ¹ and Subnet ID: | ISO on TCP (RFC 1006) and S7 communication: Local and partner CPU TSAPs in ASCII and hexadecimal formats |

¹ When configuring a connection with an S7-1200 CPU for ISO-on-TCP, use only ASCII characters in the TSAP extension for the passive communication partners.

Transport Service Access Points (TSAPs)

Using TSAPs, ISO on TCP protocol and S7 communication allows multiple connections to a single IP address (up to 64K connections). TSAPs uniquely identify these communication end point connections to an IP address.

In the "Address Details" section of the Connection Parameters dialog, you define the TSAPs to be used. The TSAP of a connection in the CPU is entered in the "Local TSAP" field. The TSAP assigned for the connection in your partner CPU is entered under the "Partner TSAP" field.

Port Numbers

With TCP and UDP protocols, the connection parameter configuration of the Local (active) connection CPU must specify the remote IP address and port number of the Partner (passive) connection CPU.

In the "Address Details" section of the Connection Parameters dialog, you define the ports to be used. The port of a connection in the CPU is entered in the "Local Port" field. The port assigned for the connection in your partner CPU is entered under the "Partner Port" field.

5.7.3 Parameters for the PROFINET connection

The TSEND_C, TRCV_C and TCON instructions require that connection-related parameters be specified in order to connect to the partner device. These parameters are assigned by the TCON_Param structure for the TCP, ISO-on-TCP, and UDP protocols. Typically, you use the "Configuration" tab of the "Properties" of the instruction to specify these parameters. If the "Configuration" tab is not accessible, then you must specify the TCON_Param structure programmatically.

TCON_Param

Table 5-7 Structure of the connection description (TCON_Param)

| Byte | Parameter and data type | | Description |
|---------|-------------------------|--------------------|--|
| 0 ... 1 | block_length | UInt | Length: 64 bytes (fixed) |
| 2 ... 3 | id | CONN_OUC (Word) | Reference to this connection: Range of values: 1 (default) to 4095. Specify the value of this parameter for the TSEND_C, TRCV_C or TCON instruction under ID. |
| 4 | connection_type | USInt | Connection type: <ul style="list-style-type: none"> • 17: TCP (default) • 18: ISO-on-TCP • 19: UDP |
| 5 | active_est | Bool | ID for the type of connection: <ul style="list-style-type: none"> • TCP and ISO-on-TCP: <ul style="list-style-type: none"> – FALSE: Passive connection – TRUE: Active connection (default) • UDP: FALSE |
| 6 | local_device_id | USInt | ID for the local PROFINET or Industrial Ethernet interface: 1 (default) |
| 7 | local_tsap_id_len | USInt | Length of parameter local_tsap_id used, in bytes; possible values: <ul style="list-style-type: none"> • TCP: 0 (active, default) or 2 (passive) • ISO-on-TCP: 2 to 16 • UDP: 2 |
| 8 | rem_subnet_id_len | USInt | This parameter is not used. |
| 9 | rem_staddr_len | USInt | Length of address of partner end point, in bytes: <ul style="list-style-type: none"> • 0: unspecified (parameter rem_staddr is irrelevant) • 4 (default): Valid IP address in parameter rem_staddr (only for TCP and ISO-on-TCP) |
| 10 | rem_tsap_id_len | USInt | Length of parameter rem_tsap_id used, in bytes; possible values: <ul style="list-style-type: none"> • TCP: 0 (passive) or 2 (active, default) • ISO-on-TCP: 2 to 16 • UDP: 0 |
| 11 | next_staddr_len | USInt | This parameter is not used. |

| Byte | Parameter and data type | | Description |
|-----------|-------------------------|-----------------------|---|
| 12 ... 27 | local_tsap_id | Array [1..16] of Byte | <p>Local address component of connection:</p> <ul style="list-style-type: none"> • TCP and ISO-on-TCP: local port no. (possible values: 1 to 49151; recommended values: 2000...5000): <ul style="list-style-type: none"> – local_tsap_id[1] = high byte of port number in hexadecimal notation; – local_tsap_id[2] = low byte of port number in hexadecimal notation; – local_tsap_id[3-16] = irrelevant • ISO-on-TCP: local TSAP-ID: <ul style="list-style-type: none"> – local_tsap_id[1] = B#16#E0; – local_tsap_id[2] = rack and slot of local end points (bits 0 to 4: slot number, bits 5 to 7: rack number); – local_tsap_id[3-16] = TSAP extension, optional • UDP: This parameter is not used. <p>Note: Make sure that every value of local_tsap_id is unique within the CPU.</p> |
| 28 ... 33 | rem_subnet_id | Array [1..6] of USInt | This parameter is not used. |
| 34 ... 39 | rem_staddr | Array [1..6] of USInt | <p>TCP and ISO-on-TCP only: IP address of the partner end point. (Not relevant for passive connections.) For example, IP address 192.168.002.003 is stored in the following elements of the array:</p> <p>rem_staddr[1] = 192 rem_staddr[2] = 168 rem_staddr[3] = 002 rem_staddr[4] = 003 rem_staddr[5-6]= irrelevant</p> |
| 40 ... 55 | rem_tsap_id | Array [1..16] of Byte | <p>Partner address component of connection</p> <ul style="list-style-type: none"> • TCP: partner port number. Range: 1 to 49151; Recommended values: 2000 to 5000): <ul style="list-style-type: none"> – rem_tsap_id[1] = high byte of the port number in hexadecimal notation – rem_tsap_id[2] = low byte of the port number in hexadecimal notation; – rem_tsap_id[3-16] = irrelevant • ISO-on-TCP: partner TSAP-ID: <ul style="list-style-type: none"> – rem_tsap_id[1] = B#16#E0 – rem_tsap_id[2] = rack and slot of partner end point (bits 0 to 4: Slot number, bits 5 to 7: rack number) – rem_tsap_id[3-16] = TSAP extension, optional • UDP: This parameter is not used. |
| 56 ... 61 | next_staddr | Array [1..6] of Byte | This parameter is not used. |
| 62 ... 63 | spare | Word | Reserved: W#16#0000 |

See also

Configuring the Local/Partner connection path (Page 150)

5.7.4 Assigning Internet Protocol (IP) addresses**5.7.4.1 Assigning IP addresses to programming and network devices**

If your programming device is using an on-board adapter card connected to your plant LAN (and possibly the world-wide web), the IP Address Network ID and subnet mask of your CPU and the programming device's on-board adapter card must be exactly the same. The Network ID is the first part of the IP address (first three octets) (for example, **211.154.184**.16) that determines what IP network you are on. The subnet mask normally has a value of **255.255.255.0**; however, since your computer is on a plant LAN, the subnet mask may have various values (for example, **255.255.254.0**) in order to set up unique subnets. The subnet mask, when combined with the device IP address in a mathematical AND operation, defines the boundaries of an IP subnet.

Note

In a World Wide Web scenario, where your programming devices, network devices, and IP routers communicate with the world, you must assign unique IP addresses to avoid conflict with other network users. Contact your company IT department personnel, who are familiar with your plant networks, for assignment of your IP addresses.

 WARNING**Unauthorized access to the CPU through the Web server**

Unauthorized access to the CPU or changing PLC variables to invalid values could disrupt process operation and could result in death, severe personal injury and/or property damage.

Enabling the Web server allows authorized users to perform operating mode changes, writes to PLC data, and firmware updates, Siemens recommends that you observe the following security practices:

- Enable access to the Web server only with the HTTPS protocol.
- Password-protect Web server user IDs (Page 604) with a strong password. Strong passwords are at least eight characters in length, mix letters, numbers, and special characters, are not words that can be found in a dictionary, and are not names or identifiers that can be derived from personal information. Keep the password secret and change it frequently.
- Do not extend the default minimum privileges of the "Everybody" user.
- Perform error-checking and range-checking on your variables in your program logic because Web page users can change PLC variables to invalid values.

If your programming device is using an Ethernet-to-USB adapter card connected to an isolated network, the IP Address Network ID and subnet mask of your CPU and the programming device's Ethernet-to-USB adapter card must be exactly the same. The Network ID is the first part of the IP address (first three octets) (for example, **211.154.184.16**) that determines what IP network you are on. The subnet mask normally has a value of **255.255.255.0**. The subnet mask, when combined with the device IP address in a mathematical AND operation, defines the boundaries of an IP subnet.

Note

An Ethernet-to-USB adapter card is useful when you do not want your programming device on your company LAN. During initial testing or commissioning tests, this arrangement is particularly useful.

Table 5- 8 Assigning Ethernet addresses

| Programming Device Adapter Card | Network Type | Internet Protocol (IP) Address | Subnet Mask |
|---------------------------------|---|---|--|
| On-board adapter card | Connected to your plant LAN (and possibly the world-wide web) | Network ID of your CPU and the programming device's on-board adapter card must be exactly the same. ¹ | The subnet mask of your CPU and the on-board adapter card must be exactly the same. The subnet mask normally has a value of 255.255.255.0 ; however, since your computer is on a plant LAN, the subnet mask may have various values (for example, 255.255.254.0) in order to set up unique subnets. ² |
| Ethernet-to-USB adapter card | Connected to an isolated network | Network ID of your CPU and the programming device's Ethernet-to-USB adapter card must be exactly the same. ¹ | The subnet mask of your CPU and the Ethernet-to-USB adapter card must be exactly the same. The subnet mask normally has a value of 255.255.255.0 . ² |

- ¹ The Network ID is the first part of the IP address (first three octets) (for example, **211.154.184.16**) that determines what IP network you are on.)
- ² The subnet mask, when combined with the device IP address in a mathematical AND operation, defines the boundaries of an IP subnet.

Assigning or checking the IP address of your programming device using "My Network Places" (on your desktop)

You can assign or check your programming device's IP address with the following menu selections:

- (Right-click) "My Network Places"
- "Properties"
- (Right-click) "Local Area Connection"
- "Properties"

In the "Local Area Connection Properties" dialog, in the "This connection uses the following items:" field, scroll down to "Internet Protocol (TCP/IP)". Click "Internet Protocol (TCP/IP)", and click the "Properties" button. Select "Obtain an IP address automatically (DHCP)" or "Use the following IP address" (to enter a static IP address).

Note

Dynamic Host Configuration Protocol (DHCP) automatically assigns an IP address to your programming device upon power up from the DHCP server.

5.7.4.2 Checking the IP address of your programming device

You can check the MAC and IP addresses of your programming device with the following menu selections:

1. In the "Project tree", expand "Online access".
2. Right-click the required network, and select "Properties".
3. In the network dialog, expand "Configurations", and select "Industrial Ethernet".

The MAC and IP addresses of the programming device are displayed.

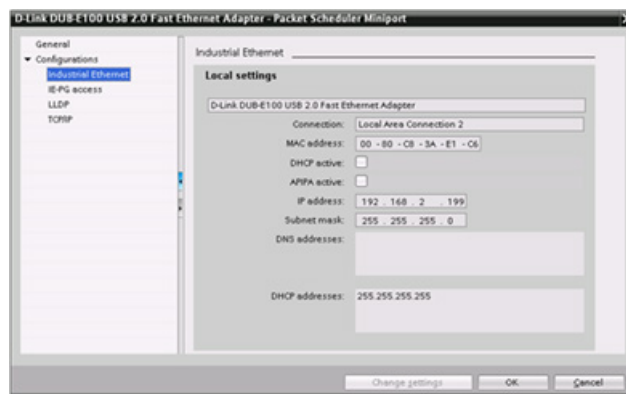

5.7.4.3 Assigning an IP address to a CPU online

You can assign an IP address to a network device online. This is particularly useful in an initial device configuration.

1. In the "Project tree," verify that no IP address is assigned to the CPU, with the following menu selections:

- "Online access"
- <Adapter card for the network in which the device is located>
- "Update accessible devices"

NOTE: If STEP 7 displays a MAC address instead of an IP address, then no IP address has been assigned.

2. Under the required accessible device, double-click "Online & diagnostics".

3. In the "Online & diagnostics" dialog, make the following menu selections:

- "Functions"
- "Assign IP address"

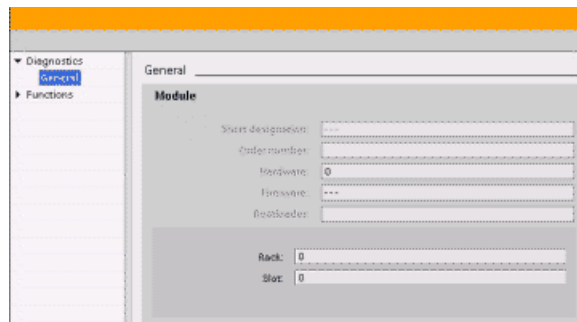
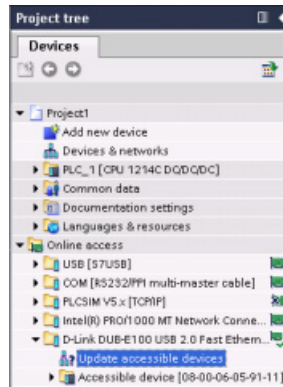

4. In the "IP address" field, enter your new IP address, and click the "Assign IP address" button.

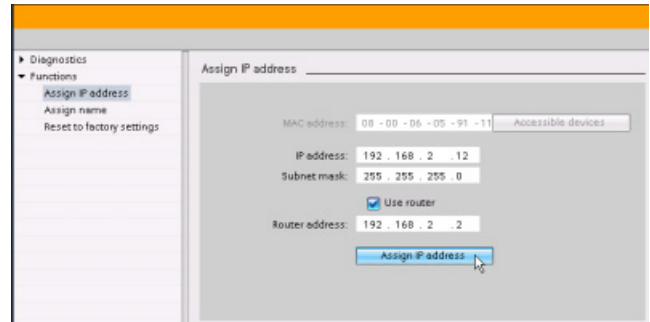

5. In the "Project tree," verify that your new IP address has been assigned to the CPU, with the following menu selections:

- "Online access"
- <Adapter for the network in which the device is located>
- "Update accessible devices"

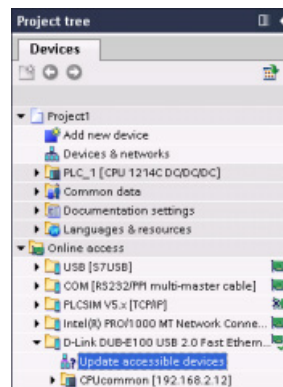

5.7.4.4 Configuring an IP address for a CPU in your project

Configuring the PROFINET interface

To configure parameters for the PROFINET interface, select the green PROFINET port box on the CPU. The "Properties" tab in the inspector window displays the PROFINET port.

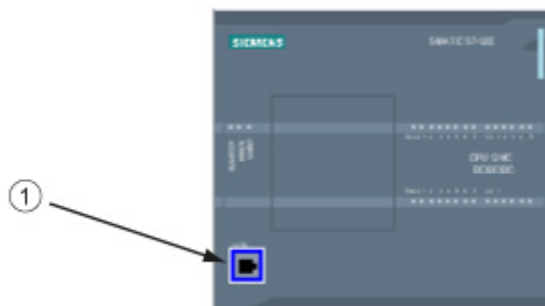

① PROFINET port

Configuring the IP address

Ethernet (MAC) address: In a PROFINET network, each device is assigned a Media Access Control address (MAC address) by the manufacturer for identification. A MAC address consists of six groups of two hexadecimal digits, separated by hyphens (-) or colons (:), in transmission order, (for example, 01-23-45-67-89-AB or 01:23:45:67:89:AB).

IP address: Each device must also have an Internet Protocol (IP) address. This address allows the device to deliver data on a more complex, routed network.

Each IP address is divided into four 8-bit segments and is expressed in a dotted, decimal format (for example, 211.154.184.16). The first part of the IP address is used for the Network ID (What network are you on?), and the second part of the address is for the Host ID (unique for each device on the network). An IP address of 192.168.x.y is a standard designation recognized as part of a private network that is not routed on the Internet.

Subnet mask: A subnet is a logical grouping of connected network devices. Nodes on a subnet tend to be located in close physical proximity to each other on a Local Area Network (LAN). A mask (known as the subnet mask or network mask) defines the boundaries of an IP subnet.

A subnet mask of 255.255.255.0 is generally suitable for a small local network. This means that all IP addresses on this network should have the same first 3 octets, and the various devices on this network are identified by the last octet (8-bit field). An example of this is to assign a subnet mask of 255.255.255.0 and an IP addresses of 192.168.2.0 through 192.168.2.255 to the devices on a small local network.

The only connection between different subnets is via a router. If subnets are used, an IP router must be employed.

IP router: Routers are the link between LANs. Using a router, a computer in a LAN can send messages to any other networks, which might have other LANs behind them. If the destination of the data is not within the LAN, the router forwards the data to another network or group of networks where it can be delivered to its destination.

Routers rely on IP addresses to deliver and receive data packets.

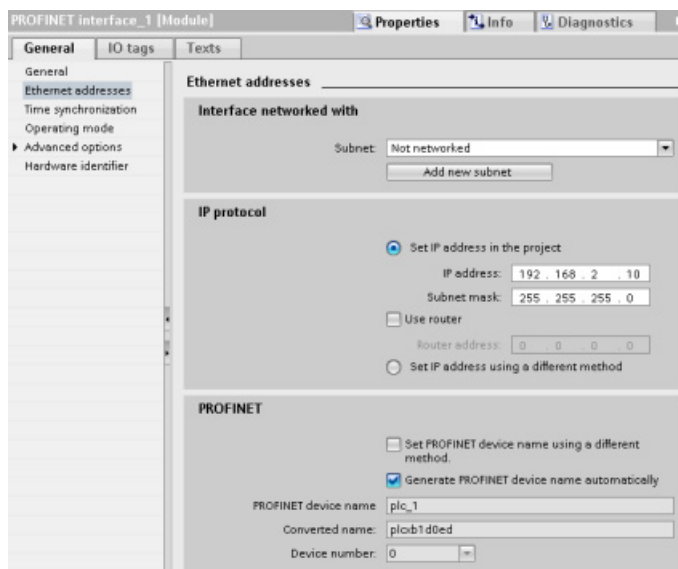

IP addresses properties: In the Properties window, select the "Ethernet addresses" configuration entry. STEP 7 displays the Ethernet address configuration dialog, which associates the software project with the IP address of the CPU that will receive that project.

Table 5- 9 Parameters for the IP address

| Parameter | Description | |
|-------------|---|--|
| Subnet | Name of the Subnet to which the device is connected. Click the "Add new subnet" button to create a new subnet. "Not connected" is the default. Two connection types are possible: <ul style="list-style-type: none"> • The "Not connected" default provides a local connection. • A subnet is required when your network has two or more devices. | |
| IP protocol | IP address | Assigned IP address for the CPU |
| | Subnet mask | Assigned subnet mask |
| | Use IP router | Click the checkbox to indicate the use of an IP router |
| | Router address | Assigned IP address for the router, if applicable |

Note

All IP addresses are configured when you download the project. If the CPU does not have a pre-configured IP address, you must associate the project with the MAC address of the target device. If your CPU is connected to a router on a network, you must also enter the IP address of the router.

The "Set IP address using a different method" radio button allows you to change the IP address online or by using the "T_CONFIG (Page 541)" instruction after the program is downloaded. This IP address assignment method is for the CPU only.

 **WARNING**
Downloading a hardware configuration with "Set IP address using different method"

After downloading a hardware configuration with the "Set IP address using a different method" option enabled, it is not possible to transition the CPU operating mode from RUN to STOP or from STOP to RUN.

User equipment continues to run under these conditions and can result in unexpected machine or process operations, which could cause death, severe personal injury, or property damage if proper precautions are not taken.

Ensure that your CPU IP address(es) are set before using the CPU in an actual automation environment. This can be done by using your STEP 7 programming package, the S7-1200 Tool, or an attached HMI device in conjunction with the T_CONFIG instruction.

WARNING

Condition in which PROFINET network might stop

When changing the IP address of a CPU online or from the user program, it is possible to create a condition in which the PROFINET network might stop.

If the IP address of a CPU is changed to an IP address outside the subnet, the PROFINET network will lose communication, and all data exchange will stop. User equipment may be configured to keep running under these conditions. Loss of PROFINET communication may result in unexpected machine or process operations, causing death, severe personal injury, or property damage if proper precautions are not taken.

If an IP address must be changed manually, ensure that the new IP address lies within the subnet.

5.7.5 Testing the PROFINET network

After completing the configuration, download the project (Page 196) to the CPU. All IP addresses are configured when you download the project.

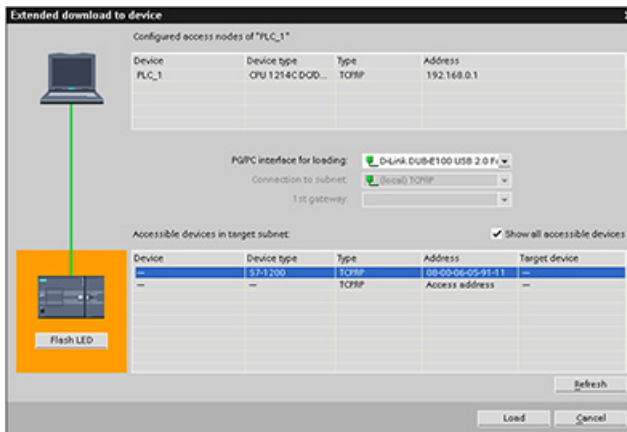

Assigning an IP address to a device online

The S7-1200 CPU does not have a pre-configured IP address. You must manually assign an IP address for the CPU:

- To assign an IP address to a device online, refer to "Device configuration: Assigning an IP address to a CPU online" (Page 158) for this step-by-step procedure.
- To assign an IP address in your project, you must configure the IP address in the Device configuration, save the configuration, and download it to the PLC. Refer to "Device configuration: Configuring an IP address for a CPU in your project" (Page 159) for more information.

Using the "Extended download to device" dialog to test for connected network devices

The S7-1200 CPU "Download to device" function and its "Extended download to device" dialog can show all accessible network devices and whether or not unique IP addresses have been assigned to all devices. To display all accessible and available devices with their assigned MAC or IP addresses, check the "Show all accessible devices" checkbox.

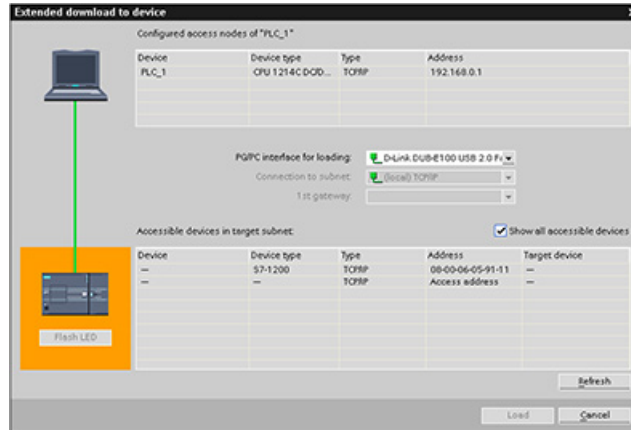

If the required network device is not in this list, communications to that device have been interrupted for some reason. The device and network must be investigated for hardware and/or configuration errors.

5.7.6 Locating the Ethernet (MAC) address on the CPU

In PROFINET networking, a Media Access Control address (MAC address) is an identifier assigned to the network interface by the manufacturer for identification. A MAC address usually encodes the manufacturer's registered identification number.

The standard (IEEE 802.3) format for printing MAC addresses in human-friendly form is six groups of two hexadecimal digits, separated by hyphens (-) or colons (:), in transmission order, (for example, 01-23-45-67-89-ab or 01:23:45:67:89:ab).

Note

Each CPU is loaded at the factory with a permanent, unique MAC address. You cannot change the MAC address of a CPU.

The MAC address is printed on the front, lower-left corner of the CPU. Note that you have to lift the lower door to see the MAC address information.

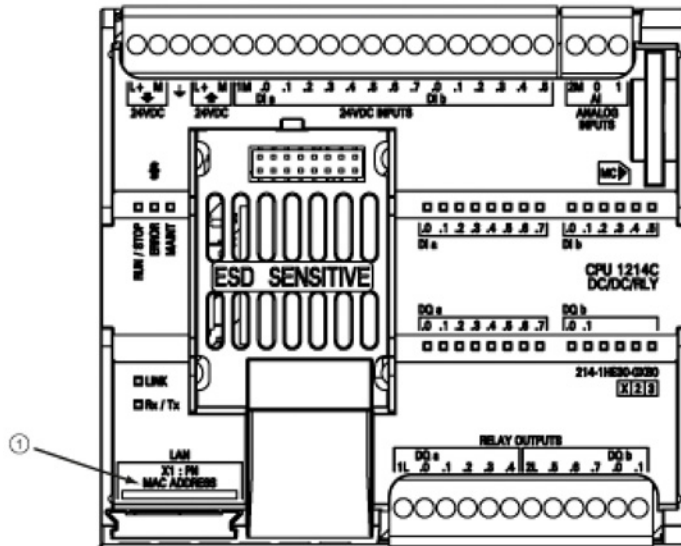

① MAC address

Initially, the CPU has no IP address, only a factory-installed MAC address. PROFINET communications requires that all devices be assigned a unique IP address.

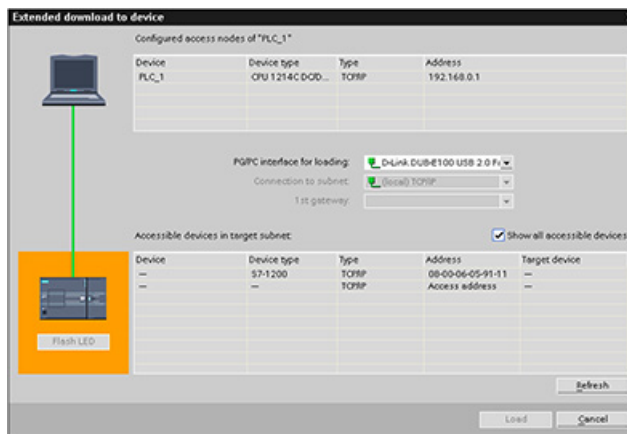

Use the CPU "Download to device" function and the "Extended download to device" dialog to show all accessible network devices and ensure that unique IP addresses have been assigned to all devices. This dialog displays all accessible and available devices with their assigned MAC or IP addresses. MAC addresses are all-important in identifying devices that are missing the required unique IP address.

5.7.7 Configuring Network Time Protocol synchronization

WARNING

If an attacker can access your networks through Network Time Protocol (NTP) synchronization, the attacker can possibly take limited control of your process by shifting the CPU system time.

The NTP client feature of the S7-1200 CPU is disabled by default, and, when enabled, only allows configured IP addresses to act as an NTP server. The CPU disables this feature by default, and you must configure this feature to allow remotely-controlled CPU system time corrections.

The S7-1200 CPU supports "time of day" interrupts and clock instructions that depend upon accurate CPU system time. If you configure NTP and accept time synchronization from a server, you must ensure that the server is a trusted source. Failure to do so can cause a security breach that allows an unknown user to take limited control of your process by shifting the CPU system time.

For security information and recommendations, please see our "Operational Guidelines for Industrial Security" (http://www.industry.siemens.com/topics/global/en/industrial-security/Documents/operational_guidelines_industrial_security_en.pdf) on the Siemens Service and Support site.

The Network Time Protocol (NTP) is widely used to synchronize the clocks of computer systems to Internet time servers. In NTP mode, the CPU sends time-of-day queries at regular intervals (in the client mode) to the NTP server in the subnet (LAN). Based on the replies from the server, the most reliable and most accurate time is calculated and the time of day on the station is synchronized.

The advantage of this mode is that it allows the time to be synchronized across subnets.

The IP addresses of up to four NTP servers need to be configured. The update interval defines the interval between the time queries (in seconds). The value of the interval ranges between 10 seconds and one day.

In NTP mode, it is generally UTC (Universal Time Coordinated) that is transferred; this corresponds to GMT (Greenwich Mean Time).

In the Properties window, select the "Time synchronization" configuration entry. STEP 7 displays the Time synchronization configuration dialog:

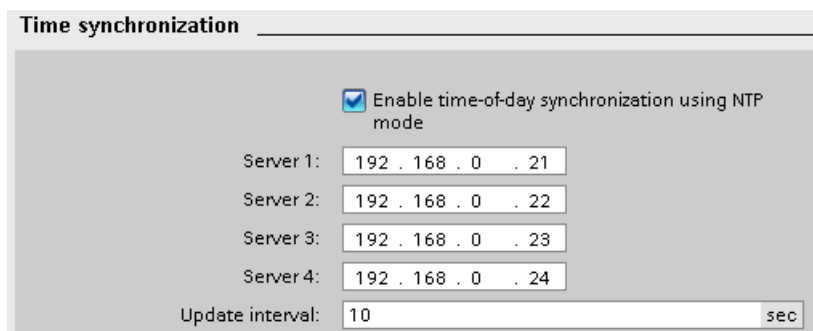

Time synchronization

Enable time-of-day synchronization using NTP mode

Server 1: 192 . 168 . 0 . 21

Server 2: 192 . 168 . 0 . 22

Server 3: 192 . 168 . 0 . 23

Server 4: 192 . 168 . 0 . 24

Update interval: 10 sec

Note

All IP addresses are configured when you download the project.

Table 5- 10 Parameters for time synchronization

| Parameter | Definition |
|--|---|
| Enable time-of-day synchronization using Network Time Protocol (NTP) servers | Click the checkbox to enable time-of-day synchronization using NTP servers. |
| Server 1 | Assigned IP Address for network time server 1 |
| Server 2 | Assigned IP Address for network time server 2 |
| Server 3 | Assigned IP Address for network time server 3 |
| Server 4 | Assigned IP Address for network time server 4 |
| Time synchronization interval | Interval value (sec) |

5.7.8 PROFINET device start-up time, naming, and address assignment

PROFINET IO can extend the start-up time for your system (configurable time-out). More devices and slow devices impact the amount of time it takes to switch to RUN.

In V4.0, you can have a maximum of 16 PROFINET IO devices on your S7-1200 PROFINET network.

Each station (or IO device) starts up independently on start-up, and this affects the overall CPU start-up time. If you set the configurable time-out too low, there may not be a sufficient overall CPU start-up time for all stations to complete start-up. If this situation occurs, false station errors will result.

In the CPU Properties under "Startup", you can find the "Parameter assignment time for distributed I/O" (time-out). The default configurable time-out is 60,000 ms (1 minute); the user can configure this time.

PROFINET device naming and addressing in STEP 7

All PROFINET devices **must** have a Device Name and an IP Address. Use STEP 7 to define the Device Names and to configure the IP addresses. Device names are downloaded to the IO devices using PROFINET DCP (Discovery and Configuration Protocol).

PROFINET address assignment at system start-up

The controller broadcasts the names of the devices to the network, and the devices respond with their MAC addresses. The controller then assigns an IP address to the device using PROFINET DCP protocol:

- If the MAC address has a configured IP address, then the station performs start-up.
- If the MAC address does not have a configured IP address, STEP 7 assigns the address that is configured in the project, and the station then performs start-up.
- If there is a problem with this process, a station error occurs and no start-up takes place. This situation causes the configurable time-out value to be exceeded.

Programming concepts

6.1 Guidelines for designing a PLC system

When designing a PLC system, you can choose from a variety of methods and criteria. The following general guidelines can apply to many design projects. Of course, you must follow the directives of your own company's procedures and the accepted practices of your own training and location.

Table 6- 1 Guidelines for designing a PLC system

| Recommended steps | Tasks |
|--------------------------------------|--|
| Partition your process or machine | Divide your process or machine into sections that have a level of independence from each other. These partitions determine the boundaries between controllers and influence the functional description specifications and the assignment of resources. |
| Create the functional specifications | Write the descriptions of operation for each section of the process or machine, such as the I/O points, the functional description of the operation, the states that must be achieved before allowing action for each actuator (such as a solenoid, a motor, or a drive), a description of the operator interface, and any interfaces with other sections of the process or machine. |
| Design the safety circuits | <p>Identify any equipment that might require hard-wired logic for safety. Remember that control devices can fail in an unsafe manner, which can produce unexpected startup or change in the operation of machinery. Where unexpected or incorrect operation of the machinery could result in physical injury to people or significant property damage, consider the implementation of electromechanical overrides (which operate independently of the PLC) to prevent unsafe operations. The following tasks should be included in the design of safety circuits:</p> <ul style="list-style-type: none"> • Identify any improper or unexpected operation of actuators that could be hazardous. • Identify the conditions that would assure the operation is not hazardous, and determine how to detect these conditions independently of the PLC. • Identify how the PLC affects the process when power is applied and removed, and also identify how and when errors are detected. Use this information only for designing the normal and expected abnormal operation. You should not rely on this "best case" scenario for safety purposes. • Design the manual or electromechanical safety overrides that block the hazardous operation independent of the PLC. • Provide the appropriate status information from the independent circuits to the PLC so that the program and any operator interfaces have necessary information. • Identify any other safety-related requirements for safe operation of the process. |
| Plan system security | Determine what level of protection (Page 190) you require for access to your process. You can password-protect CPUs and program blocks from unauthorized access. |

| Recommended steps | Tasks |
|-----------------------------------|--|
| Specify the operator stations | Based on the requirements of the functional specifications, create the following drawings of the operator stations: <ul style="list-style-type: none"> • Overview drawing that shows the location of each operator station in relation to the process or machine. • Mechanical layout drawing of the devices for the operator station, such as display, switches, and lights. • Electrical drawings with the associated I/O of the PLC and signal modules. |
| Create the configuration drawings | Based on the requirements of the functional specification, create configuration drawings of the control equipment: <ul style="list-style-type: none"> • Overview drawing that shows the location of each PLC in relation to the process or machine. • Mechanical layout drawing of each PLC and any I/O modules, including any cabinets and other equipment. • Electrical drawings for each PLC and any I/O modules, including the device model numbers, communications addresses, and I/O addresses. |
| Create a list of symbolic names | Create a list of symbolic names for the absolute addresses. Include not only the physical I/O signals, but also the other elements (such as tag names) to be used in your program. |

6.2 Structuring your user program

When you create a user program for the automation tasks, you insert the instructions for the program into code blocks:

- An organization block (OB) responds to a specific event in the CPU and can interrupt the execution of the user program. The default for the cyclic execution of the user program (OB 1) provides the base structure for your user program. If you include other OBs in your program, these OBs interrupt the execution of OB 1. The other OBs perform specific functions, such as for startup tasks, for handling interrupts and errors, or for executing specific program code at specific time intervals.
- A function block (FB) is a subroutine that is executed when called from another code block (OB, FB, or FC). The calling block passes parameters to the FB and also identifies a specific data block (DB) that stores the data for the specific call or instance of that FB. Changing the instance DB allows a generic FB to control the operation of a set of devices. For example, one FB can control several pumps or valves, with different instance DBs containing the specific operational parameters for each pump or valve.
- A function (FC) is a subroutine that is executed when called from another code block (OB, FB, or FC). The FC does not have an associated instance DB. The calling block passes parameters to the FC. The output values from the FC must be written to a memory address or to a global DB.

Choosing the type of structure for your user program

Based on the requirements of your application, you can choose either a linear structure or a modular structure for creating your user program:

- A linear program executes all of the instructions for your automation tasks in sequence, one after the other. Typically, the linear program puts all of the program instructions into the OB for the cyclic execution of the program (OB 1).
- A modular program calls specific code blocks that perform specific tasks. To create a modular structure, you divide the complex automation task into smaller subordinate tasks that correspond to the technological functions of the process. Each code block provides the program segment for each subordinate task. You structure your program by calling one of the code blocks from another block.

Linear structure:

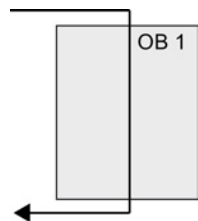

Modular structure:

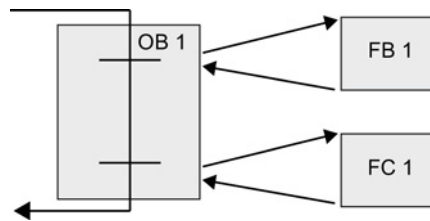

By creating generic code blocks that can be reused within the user program, you can simplify the design and implementation of the user program. Using generic code blocks has a number of benefits:

- You can create reusable blocks of code for standard tasks, such as for controlling a pump or a motor. You can also store these generic code blocks in a library that can be used by different applications or solutions.
- When you structure the user program into modular components that relate to functional tasks, the design of your program can be easier to understand and to manage. The modular components not only help to standardize the program design, but can also help to make updating or modifying the program code quicker and easier.
- Creating modular components simplifies the debugging of your program. By structuring the complete program as a set of modular program segments, you can test the functionality of each code block as it is developed.
- Creating modular components that relate to specific technological functions can help to simplify and reduce the time involved with commissioning the completed application.

6.3 Using blocks to structure your program

By designing FBs and FCs to perform generic tasks, you create modular code blocks. You then structure your program by having other code blocks call these reusable modules. The calling block passes device-specific parameters to the called block.

When a code block calls another code block, the CPU executes the program code in the called block. After execution of the called block is complete, the CPU resumes the execution of the calling block. Processing continues with execution of the instruction that follows after the block call.

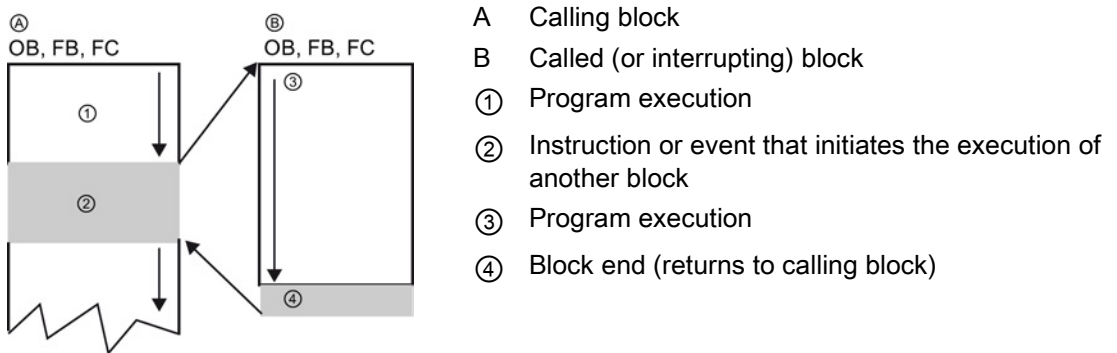

You can nest the block calls for a more modular structure. In the following example, the nesting depth is 3: the program cycle OB plus 3 layers of calls to code blocks.

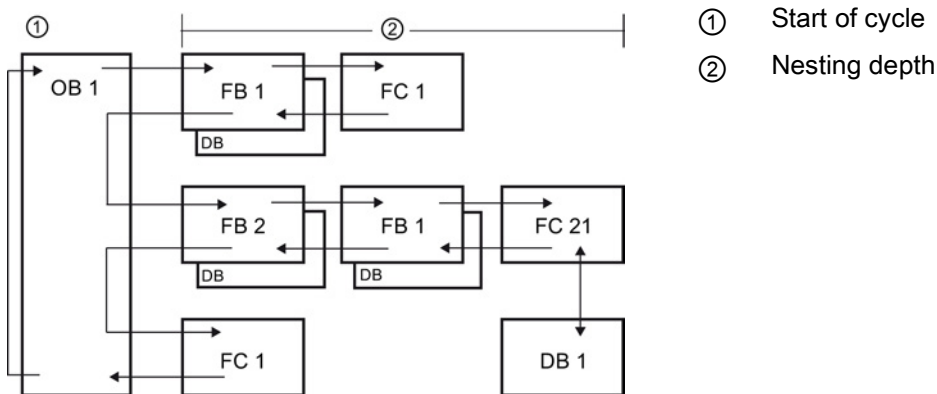

6.3.1 Organization block (OB)

Organization blocks provide structure for your program. They serve as the interface between the operating system and the user program. OBs are event driven. An event, such as a diagnostic interrupt or a time interval, causes the CPU to execute an OB. Some OBs have predefined start events and behavior.

The program cycle OB contains your main program. You can include more than one program cycle OB in your user program. During RUN mode, the program cycle OBs execute at the lowest priority level and can be interrupted by all other event types. The startup OB does not interrupt the program cycle OB because the CPU executes the startup OB before going to RUN mode.

After finishing the processing of the program cycle OBs, the CPU immediately executes the program cycle OBs again. This cyclic processing is the "normal" type of processing used for programmable logic controllers. For many applications, the entire user program is located in a single program cycle OB.

You can create other OBs to perform specific functions, such as for handling interrupts and errors, or for executing specific program code at specific time intervals. These OBs interrupt the execution of the program cycle OBs.

Use the "Add new block" dialog to create new OBs in your user program.

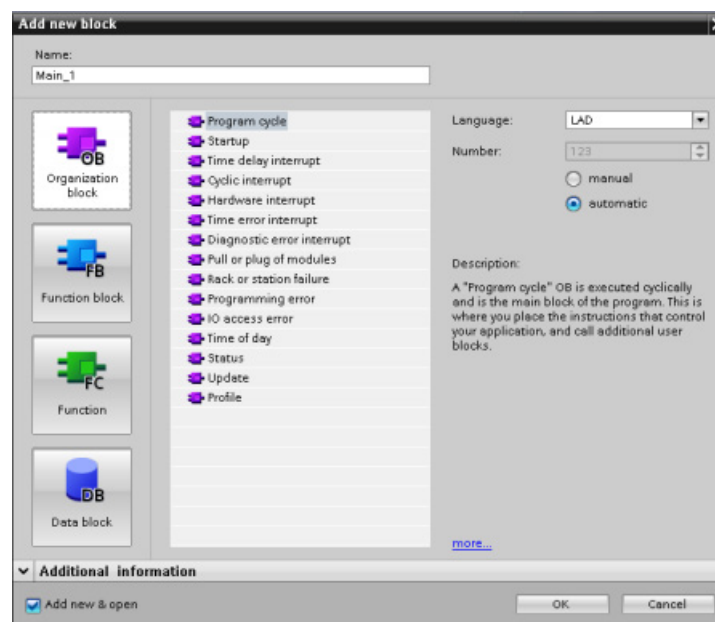

Interrupt handling is always event-driven. When such an event occurs, the CPU interrupts the execution of the user program and calls the OB that was configured to handle that event. After finishing the execution of the interrupting OB, the CPU resumes the execution of the user program at the point of interruption.

The CPU determines the order for handling interrupt events by priority. You can assign multiple interrupt events to the same priority class. For more information, refer to the topics on organization blocks (Page 85) and execution of the user program (Page 77).

Creating additional OBs

You can create multiple OBs for your user program, even for the program cycle and startup OB events. Use the "Add new block" dialog to create an OB and enter a name for your OB.

If you create multiple program cycle OBs for your user program, the CPU executes each program cycle OB in numerical sequence, starting with the program cycle OB with the lowest number (such as OB 1). For example: after the first program cycle OB (such as OB 1) finishes, the CPU executes the program cycle OB with the next higher number.

Configuring the properties of an OB

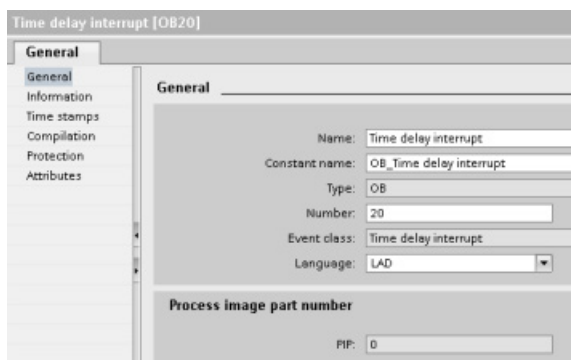

You can modify the properties of an OB. For example, you can configure the OB number or programming language.

Note

Note that you can assign a process image part number to an OB that corresponds to PIP0, PIP1, PIP2, PIP3, or PIP4. If you enter a number for the process image part number, the CPU creates that process image partition. See the topic "Execution of the user program (Page 77)" for an explanation of the process image partitions.

6.3.2 Function (FC)

A function (FC) is a code block that typically performs a specific operation on a set of input values. The FC stores the results of this operation in memory locations. For example, use FCs to perform standard and reusable operations (such as for mathematical calculations) or technological functions (such as for individual controls using bit logic operations). An FC can also be called several times at different points in a program. This reuse simplifies the programming of frequently recurring tasks.

An FC does not have an associated instance data block (DB). The FC uses the local data stack for the temporary data used to calculate the operation. The temporary data is not saved. To store data permanently, assign the output value to a global memory location, such as M memory or to a global DB.

6.3.3 Function block (FB)

A function block (FB) is a code block that uses an instance data block for its parameters and static data. FBs have variable memory that is located in a data block (DB), or "instance" DB. The instance DB provides a block of memory that is associated with that instance (or call) of the FB and stores data after the FB finishes. You can associate different instance DBs with different calls of the FB. The instance DBs allow you to use one generic FB to control multiple devices. You structure your program by having one code block make a call to an FB and an instance DB. The CPU then executes the program code in that FB, and stores the block parameters and the static local data in the instance DB. When the execution of the FB finishes, the CPU returns to the code block that called the FB. The instance DB retains the values for that instance of the FB. These values are available to subsequent calls to the function block either in the same scan cycle or other scan cycles.

Reusable code blocks with associated memory

You typically use an FB to control the operation for tasks or devices that do not finish their operation within one scan cycle. To store the operating parameters so that they can be quickly accessed from one scan to the next, each FB in your user program has one or more instance DBs. When you call an FB, you also specify an instance DB that contains the block parameters and the static local data for that call or "instance" of the FB. The instance DB maintains these values after the FB finishes execution.

By designing the FB for generic control tasks, you can reuse the FB for multiple devices by selecting different instance DBs for different calls of the FB.

An FB stores the Input, Output, and InOut, and Static parameters in an instance DB.

You can also modify and download the function block interface in RUN mode.

Assigning the start value in the instance DB

The instance DB stores both a default value and a start value for each parameter. The start value provides the value to be used when the FB is executed. The start value can then be modified during the execution of your user program.

The FB interface also provides a "Default value" column that allows you to assign a new start value for the parameter as you are writing the program code. This default value in the FB is then transferred to the start value in the associated instance DB. If you do not assign a new start value for a parameter in the FB interface, the default value from instance DB is copied to start value.

Using a single FB with DBs

The following figure shows an OB that calls one FB three times, using a different data block for each call. This structure allows one generic FB to control several similar devices, such as motors, by assigning a different instance data block for each call for the different devices. Each instance DB stores the data (such as speed, ramp-up time, and total operating time) for an individual device.

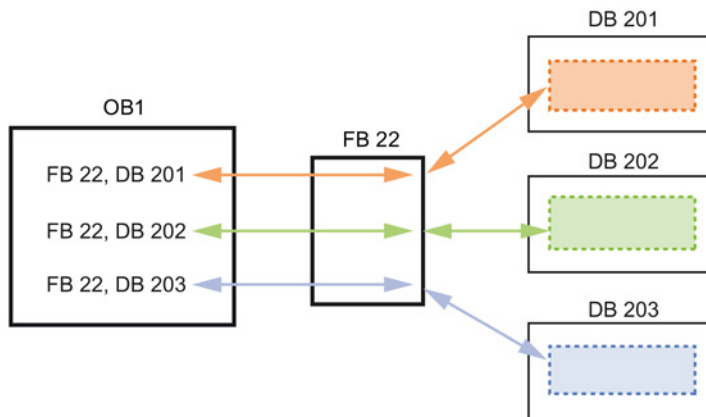

In this example, FB 22 controls three separate devices, with DB 201 storing the operational data for the first device, DB 202 storing the operational data for the second device, and DB 203 storing the operational data for the third device.

6.3.4 Data block (DB)

You create data blocks (DB) in your user program to store data for the code blocks. All of the program blocks in the user program can access the data in a global DB, but an instance DB stores data for a specific function block (FB).

The data stored in a DB is not deleted when the execution of the associated code block comes to an end. There are two types of DBs:

- A global DB stores data for the code blocks in your program. Any OB, FB, or FC can access the data in a global DB.
- An instance DB stores the data for a specific FB. The structure of the data in an instance DB reflects the parameters (Input, Output, and InOut) and the static data for the FB. (The Temp memory for the FB is not stored in the instance DB.)

Note

Although the instance DB reflects the data for a specific FB, any code block can access the data in an instance DB.

You can also modify and download data blocks in RUN mode (Page 808).

Read-only data blocks

You can configure a DB as being read-only:

1. Right-click the DB in the project navigator and select "Properties" from the context menu.
2. In the "Properties" dialog, select "Attributes".
3. Select the "Data block write-protected in the device" option and click "OK".

Optimized and standard data blocks

You can also configure a data block to be either standard or optimized. A standard DB is compatible with STEP 7 Classic programming tools and the classic S7-300 and S7-400 CPUs. Data blocks with optimized access have no fixed defined structure. The data elements contain only a symbolic name in the declaration and no fixed address within the block. The CPU stores the elements automatically in the available memory area of the block so that there are no gaps in the memory. This makes for optimal use of the memory capacity.

To set optimized access for a data block, follow these steps:

1. Expand the program blocks folder in the STEP 7 project tree.
2. Right-click the data block and select "Properties" from the context menu.
3. For the attributes, select "Optimized block access".

Note that optimized block access is the default for new data blocks. If you deselect "Optimized block access", the block uses standard access.

6.3.5 Creating reusable code blocks

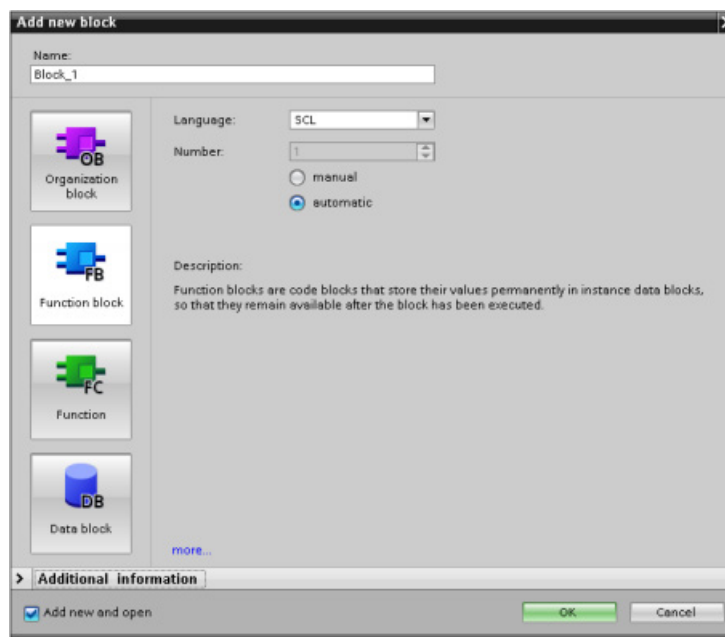

Use the "Add new block" dialog under "Program blocks" in the Project navigator to create OBs, FBs, FCs, and global DBs. When you create a code block, you select the programming language for the block. You do not select a language for a DB because it only stores data. Selecting the "Add new and open" check box (default) opens the code block in the Project view.

You can store objects you want to reuse in libraries. For each project, there is a project library that is connected to the project. In addition to the project library, you can create any number of global libraries that can be used over several projects. Since the libraries are compatible with each other, library elements can be copied and moved from one library to another.

Libraries are used, for example, to create templates for blocks that you first paste into the project library and then further develop there. Finally, you copy the blocks from the project library to a global library. You make the global library available to other colleagues working on your project. They use the blocks and further adapt them to their individual requirements, where necessary.

For details about library operations, refer to the STEP 7 online Help library topics.

6.4 Understanding data consistency

The CPU maintains the data consistency for all of the elementary data types (such as Words or DWords) and all of the system-defined structures (for example, IEC_TIMERS or DTL). The reading or writing of the value cannot be interrupted. (For example, the CPU protects the access to a DWord value until the four bytes of the DWord have been read or written.) To ensure that the program cycle OBs and the interrupt OBs cannot write to the same memory location at the same time, the CPU does not execute an interrupt OB until the read or write operation in the program cycle OB has been completed.

If your user program shares multiple values in memory between a program cycle OB and an interrupt OB, your user program must also ensure that these values are modified or read consistently. You can use the DIS_AIRT (disable alarm interrupt) and EN_AIRT (enable alarm interrupt) instructions in your program cycle OB to protect any access to the shared values.

- Insert a DIS_AIRT instruction in the code block to ensure that an interrupt OB cannot be executed during the read or write operation.
- Insert the instructions that read or write the values that could be altered by an interrupt OB.
- Insert an EN_AIRT instruction at the end of the sequence to cancel the DIS_AIRT and allow the execution of the interrupt OB.

A communication request from an HMI device or another CPU can also interrupt execution of the program cycle OB. The communication requests can also cause issues with data consistency. The CPU ensures that the elementary data types are always read and written consistently by the user program instructions. Because the user program is interrupted periodically by communications, it is not possible to guarantee that multiple values in the CPU will all be updated at the same time by the HMI. For example, the values displayed on a given HMI screen could be from different scan cycles of the CPU.

The PtP (Point-to-Point) instructions, PROFINET instructions (such as TSEND_C and TRCV_C), PROFINET Distributed I/O instructions, and PROFIBUS Distributed I/O Instructions (Page 314) transfer buffers of data that could be interrupted. Ensure the data consistency for the buffers of data by avoiding any read or write operation to the buffers in both the program cycle OB and an interrupt OB. If it is necessary to modify the buffer values for these instructions in an interrupt OB, use a DIS_AIRT instruction to delay any interruption (an interrupt OB or a communication interrupt from an HMI or another CPU) until an EN_AIRT instruction is executed.

Note

The use of the DIS_AIRT instruction delays the processing of interrupt OBs until the EN_AIRT instruction is executed, affecting the interrupt latency (time from an event to the time when the interrupt OB is executed) of your user program.

6.5 Programming language

STEP 7 provides the following standard programming languages for S7-1200:

- LAD (ladder logic) is a graphical programming language. The representation is based on circuit diagrams (Page 180).
- FBD (Function Block Diagram) is a programming language that is based on the graphical logic symbols used in Boolean algebra (Page 181).
- SCL (structured control language) is a text-based, high-level programming language (Page 181).

When you create a code block, you select the programming language to be used by that block.

Your user program can utilize code blocks created in any or all of the programming languages.

6.5.1 Ladder logic (LAD)

The elements of a circuit diagram, such as normally closed and normally open contacts, and coils are linked to form networks.

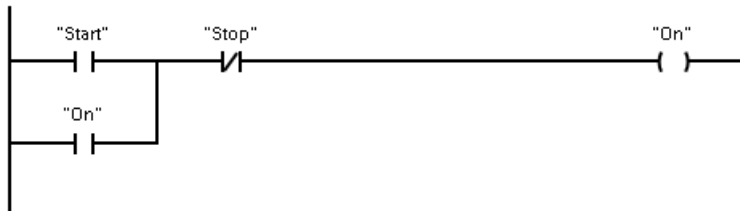

To create the logic for complex operations, you can insert branches to create the logic for parallel circuits. Parallel branches are opened downwards or are connected directly to the power rail. You terminate the branches upwards.

LAD provides "box" instructions for a variety of functions, such as math, timer, counter, and move.

STEP 7 does not limit the number of instructions (rows and columns) in a LAD network.

Note

Every LAD network must terminate with a coil or a box instruction.

Consider the following rules when creating a LAD network:

- You cannot create a branch that could result in a power flow in the reverse direction.

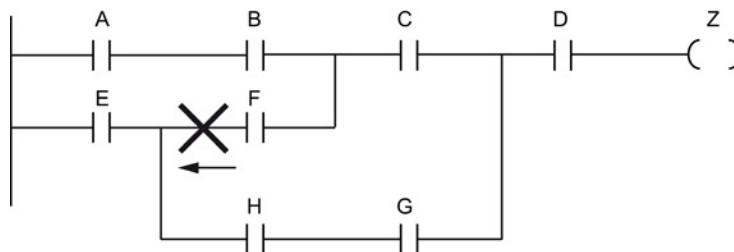

- You cannot create a branch that would cause a short circuit.

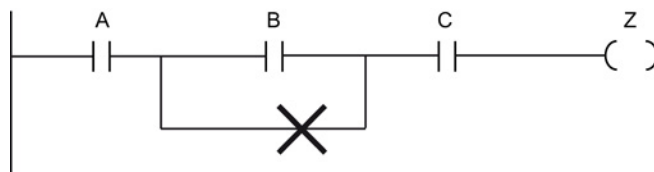

6.5.2 Function Block Diagram (FBD)

Like LAD, FBD is also a graphical programming language. The representation of the logic is based on the graphical logic symbols used in Boolean algebra.

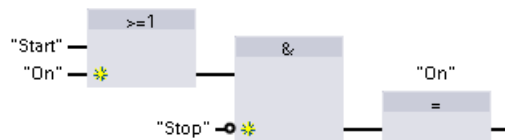

To create the logic for complex operations, insert parallel branches between the boxes.

Mathematical functions and other complex functions can be represented directly in conjunction with the logic boxes.

STEP 7 does not limit the number of instructions (rows and columns) in an FBD network.

6.5.3 SCL

Structured Control Language (SCL) is a high-level, PASCAL-based programming language for the SIMATIC S7 CPUs. SCL supports the block structure of STEP 7 (Page 172). Your project can include program blocks in any of the three programming languages: SCL, LAD, and FBD.

SCL instructions use standard programming operators, such as for assignment (`:=`), mathematical functions (+ for addition, - for subtraction, * for multiplication, and / for division). SCL also uses standard PASCAL program control operations, such as IF-THEN-ELSE, CASE, REPEAT-UNTIL, GOTO and RETURN. You can use any PASCAL reference for syntactical elements of the SCL programming language. Many of the other instructions for SCL, such as timers and counters, match the LAD and FBD instructions. For more information about specific instructions, refer to the specific instructions in the chapters for Basic instructions (Page 203) and Extended instructions (Page 283).

You can designate any type of block (OB, FB, or FC) to use the SCL programming language at the time you create the block. STEP 7 provides an SCL program editor that includes the following elements:

- Interface section for defining the parameters of the code block
- Code section for the program code
- Instruction tree that contains the SCL instructions supported by the CPU

You enter the SCL code for your instruction directly in the code section. The editor includes buttons for common code constructs and comments. For more complex instructions, simply drag the SCL instructions from the instruction tree and drop them into your program. You can also use any text editor to create an SCL program and then import that file into STEP 7.

| Interface | | | |
|-----------|-------------------|-----------|---------|
| | Name | Data type | Comment |
| 1 | ▼ Input | | |
| 2 | ■ StartStopSwitch | Bool | |
| 3 | ▼ Output | | |
| 4 | ■ RunYesNo | Bool | |
| 5 | ▼ InOut | | |
| 6 | ■ <Add new> | | |
| 7 | ▼ Temp | | |
| 8 | ■ <Add new> | | |
| 9 | ▼ Return | | |
| 10 | ■ Ret_Val | Void | |

| IF... | CASE... OF... | FOR... TO DO... | WHILE... DO... | (*...*) |
|-------|------------------|-------------------------|-------------------|---------|
| 1 | IF | condition | THEN | |
| 2 | | // Statement section IF | | |
| 3 | | ; | | |
| 4 | END_IF; | | | |

In the Interface section of the SCL code block you can declare the following types of parameters:

- Input, Output, InOut, and Ret_Val: These parameters define the input tags, output tags, and return value for the code block. The tag name that you enter here is used locally during the execution of the code block. You typically would not use the global tag name in the tag table.
- Static (FBs only; the illustration above is for an FC): The code block uses static tags for storage of static intermediate results in the instance data block. The block retains static data until overwritten, which can be after several cycles. The names of the blocks, which this block calls as multi-instance, are also stored in the static local data.
- Temp: These parameters are the temporary tags that are used during the execution of the code block.

If you call the SCL code block from another code block, the parameters of the SCL code block appear as inputs or outputs.

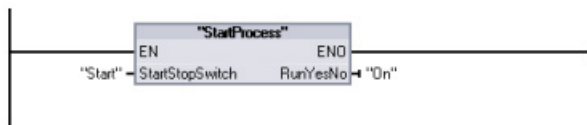

In this example, the tags for "Start" and "On" (from the project tag table) correspond to "StartStopSwitch" and "RunYesNo" in the declaration table of the SCL program.

Constructing an SCL expression

An SCL expression is a formula for calculating a value. The expression consists of operands and operators (such as *, /, + or -). The operands can be tags, constants, or expressions.

The evaluation of the expression occurs in a certain order, which is defined by the following factors:

- Every operator has a pre-defined priority, with the highest-priority operation performed first.
- For operators with equal priority, the operators are processed in a left-to-right sequence.
- You use parentheses to designate a series of operators to be evaluated together.

The result of an expression can be used either for assigning a value to a tag used by your program, as a condition to be used by a control statement, or as parameters for another SCL instruction or for calling a code block.

Table 6- 2 Operators in SCL

| Type | Operation | Operator | Priority |
|-------------|------------------------------|----------|----------|
| Parentheses | (<i>Expression</i>) | (,) | 1 |
| Math | Power | ** | 2 |
| | Sign (unary plus) | + | 3 |
| | Sign (unary minus) | - | 3 |
| | Multiplication | * | 4 |
| | Division | / | 4 |
| | Modulo | MOD | 4 |
| | Addition | + | 5 |
| | Subtraction | - | 5 |
| Comparison | Less than | < | 6 |
| | Less than or equal to | <= | 6 |
| | Greater than | > | 6 |
| | Greater than or equal to | >= | 6 |
| | Equal to | = | 7 |
| | Not equal to | <> | 7 |
| Bit logic | Negation (unary) | NOT | 3 |
| | AND logic operation | AND or & | 8 |
| | Exclusive OR logic operation | XOR | 9 |
| | OR logic operation | OR | 10 |
| Assignment | Assignment | := | 11 |

As a high-level programming language, SCL uses standard statements for basic tasks:

- Assignment statement: :=
- Mathematical functions: +, -, *, and /
- Addressing of global variables (tags): "<tag name>" (Tag name or data block name enclosed in double quotes)
- Addressing of local variables: #<variable name> (Variable name preceded by "#" symbol)

The following examples show different expressions for different uses.

| | |
|--|---|
| <code>"C" := #A+#B;</code> | Assigns the sum of two local variables to a tag |
| <code>"Data_block_1".Tag := #A;</code> | Assignment to a data block tag |
| <code>IF #A > #B THEN "C" := #A;</code> | Condition for the IF-THEN statement |
| <code>"C" := SQR (SQR (#A) + SQR (#B));</code> | Parameters for the SQR instruction |

Arithmetic operators can process various numeric data types. The data type of the result is determined by the data type of the most-significant operands. For example, a multiplication operation that uses an INT operand and a REAL operand yields a REAL value for the result.

Control statements

A control statement is a specialized type of SCL expression that performs the following tasks:

- Program branching
- Repeating sections of the SCL program code
- Jumping to other parts of the SCL program
- Conditional execution

The SCL control statements include IF-THEN, CASE-OF, FOR-TO-DO, WHILE-DO, REPEAT-UNTIL, CONTINUE, GOTO, and RETURN.

A single statement typically occupies one line of code. You can enter multiple statements on one line, or you can break a statement into several lines of code to make the code easier to read. Separators (such as tabs, line breaks and extra spaces) are ignored during the syntax check. An END statement terminates the control statement.

The following examples show a FOR-TO-DO control statement. (Both forms of coding are syntactically valid.)

```
FOR x := 0 TO max DO sum := sum + value(x); END_FOR;
FOR x := 0 TO max DO
    sum := sum + value(x);
END_FOR;
```

A control statement can also be provided with a label. A label is set off by a colon at the beginning of the statement:

```
Label: <Statement>;
```

The STEP 7 online help provides a complete SCL programming language reference.

Conditions

A condition is a comparison expression or a logical expression whose result is of type BOOL (with the value of either TRUE or FALSE). The following example shows conditions of various types.

| | |
|---|-----------------------------------|
| <code>#Temperature > 50</code> | Relational expression |
| <code>#Counter <= 100</code> | |
| <code>#CHAR1 < 'S'</code> | |
| <code>(#Alpha <> 12) AND NOT #Beta</code> | Comparison and logical expression |
| <code>5 + #Alpha</code> | Arithmetic expression |

A condition can use arithmetic expressions:

- The condition of the expression is TRUE if the result is any value other than zero.
- The condition of the expression is FALSE if the result equals zero.

Addressing

As with LAD and FBD, SCL allows you to use either tags (symbolic addressing) or absolute addresses in your user program. SCL also allows you to use a variable as an array index.

Absolute addressing

| | |
|---------------------|---|
| <code>%I0.0</code> | Precede absolute addresses with the "%" symbol. Without the "%", STEP 7 generates an undefined tag error at compile time. |
| <code>%MB100</code> | |

Symbolic addressing

| | |
|---|-------------------------------------|
| <code>"PLC_Tag_1"</code> | Tag in PLC tag table |
| <code>"Data_block_1".Tag_1</code> | Tag in a data block |
| <code>"Data_block_1".MyArray[#i]</code> | Array element in a data block array |

Indexed addressing with PEEK and POKE instructions

SCL provides PEEK and POKE instructions that allow you to read from or write to data blocks, I/O, or memory. You provide parameters for specific byte offsets or bit offsets for the operation.

Note

To use the PEEK and POKE instructions with data blocks, you must use standard (not optimized) data blocks. Also note that the PEEK and POKE instructions merely transfer data. They have no knowledge of data types at the addresses.

```
PEEK(area:=_in_,
      dbNumber:=_in_,
      byteOffset:=_in_);
```

Reads the byte referenced by byteOffset of the referenced data block, I/O or memory area.

Example referencing data block:

```
%MB100 := PEEK(area:=16#84,
               dbNumber:=1, byteOffset:=#i);
```

Example referencing IB3 input:

```
%MB100 := PEEK(area:=16#81,
               dbNumber:=0, byteOffset:=#i); // when
#i = 3
```

```
PEEK_WORD(area:=_in_,
           dbNumber:=_in_,
           byteOffset:=_in_);
```

Reads the word referenced by byteOffset of the referenced data block, I/O or memory area.

Example:

```
%MW200 := PEEK_WORD(area:=16#84,
                    dbNumber:=1, byteOffset:=#i);
```

Reads the double word referenced by byteOffset of the referenced data block, I/O or memory area.

Example:

```
%MD300 := PEEK_DWORD(area:=16#84,
                     dbNumber:=1, byteOffset:=#i);
```

```
PEEK_DWORD(area:=_in_,
            dbNumber:=_in_,
            byteOffset:=_in_);
```

Reads a Boolean referenced by the bitOffset and byteOffset of the referenced data block, I/O or memory area

Example:

```
%MB100.0 := PEEK_BOOL(area:=16#84,
                      dbNumber:=1, byteOffset:=#ii,
                      bitOffset:=#j);
```

```
PEEK_BOOL(area:=_in_,
           dbNumber:=_in_,
           byteOffset:=_in_,
           bitOffset:=_in_);
```

Writes the value (Byte, Word, or DWord) to the referenced byteOffset of the referenced data block, I/O or memory area

Example referencing data block:

```
POKE(area:=16#84, dbNumber:=2,
      byteOffset:=3, value:="Tag_1");
```

Example referencing QB3 output:

```
POKE(area:=16#82, dbNumber:=0,
      byteOffset:=3, value:="Tag_1");
```

```
POKE(area:=_in_,
      dbNumber:=_in_,
      byteOffset:=_in_,
      value:=_in_);
```

```
POKE_BOOL(area:=_in_,
           dbNumber:=_in_,
           byteOffset:=_in_,
           bitOffset:=_in_,
           value:=_in_);
```

Writes the Boolean value to the referenced bitOffset and byteOffset of the referenced data block, I/O or memory area

Example:

```
POKE_BOOL(area:=16#84, dbNumber:=2,
           byteOffset:=3, bitOffset:=5,
           value:=0);
```

```
POKE_BLK(area_src:=_in_,
          dbNumber_src:=_in_,
          byteOffset_src:=_in_,
          area_dest:=_in_,
          dbNumber_dest:=_in_,
          byteOffset_dest:=_in_,
          count:=_in_);
```

Writes "count" number of bytes starting at the referenced byte Offset of the referenced source data block, I/O or memory area to the referenced byteOffset of the referenced destination data block, I/O or memory area

Example:

```
POKE_BLK(area_src:=16#84,
          dbNumber_src:=#src_db,
          byteOffset_src:=#src_byte,
          area_dest:=16#84,
          dbNumber_dest:=#src_db,
          byteOffset_dest:=#src_byte,
          count:=10);
```

For PEEK and POKE instructions, the following values for the "area", "area_src" and "area_dest" parameters are applicable. For areas other than data blocks, the dbNumber parameter must be 0.

| | |
|-------|----|
| 16#81 | I |
| 16#82 | Q |
| 16#83 | M |
| 16#84 | DB |

Calling other code blocks from your SCL program

To call another code block in your user program, simply enter the name (or absolute address) of the FB or FC with the parameters. For an FB, you must provide the instance DB to be called with the FB.

| | |
|---|---------------------------|
| <DB name> (Parameter list) | Call as a single instance |
| <#Instance name> (Parameter list) | Call as multi-instance |
| "MyDB" (MyInput:=10, MyInOut:="Tag1"); | |
| <FC name> (Parameter list) | Standard call |
| <Operand>:=<FC name> (Parameter list) | Call in an expression |
| "MyFC" (MyInput:=10, MyInOut:="Tag1"); | |

You can also drag blocks from the navigation tree to the SCL program editor, and complete the parameter assignment.

Adding block comments to SCL code

You can include a block comment in your SCL code by including the comment text between (* and *). You can have any number of comment lines between the (* and the *). Your SCL program block can include many block comments. For programming convenience, the SCL editor includes a block comment button along with common control statements:



6.5.4 EN and ENO for LAD, FBD and SCL

Determining "power flow" (EN and ENO) for an instruction

Certain instructions (such as the Math and the Move instructions) provide parameters for EN and ENO. These parameters relate to power flow in LAD or FBD and determine whether the instruction is executed during that scan. SCL also allows you to set the ENO parameter for a code block.

- EN (Enable In) is a Boolean input. Power flow (EN = 1) must be present at this input for the box instruction to be executed. If the EN input of a LAD box is connected directly to the left power rail, the instruction will always be executed.
- ENO (Enable Out) is a Boolean output. If the box has power flow at the EN input and the box executes its function without error, then the ENO output passes power flow (ENO = 1) to the next element. If an error is detected in the execution of the box instruction, then power flow is terminated (ENO = 0) at the box instruction that generated the error.

Table 6- 3 Operands for EN and ENO

| Program editor | Inputs/outputs | Operands | Data type |
|----------------|------------------|------------------------------------|-----------|
| LAD | EN, ENO | Power flow | Bool |
| FBD | EN | I, I:P, Q, M, DB, Temp, Power Flow | Bool |
| | ENO | Power Flow | Bool |
| SCL | EN ¹ | TRUE, FALSE | Bool |
| | ENO ² | TRUE, FALSE | Bool |

¹ The use of EN is only available for FBs.

² The use of ENO with the SCL code block is optional. You must configure the SCL compiler to set ENO when the code block finishes.

Configuring SCL to set ENO

To configure the SCL compiler for setting ENO, follow these steps:

1. Select the "Settings" command from the "Options" menu.
2. Expand the "PLC programming" properties and select "SCL (Structured Control Language)".
3. Select the "Set ENO automatically" option.

Using ENO in program code

You can also use ENO in your program code, for example by assigning ENO to a PLC tag, or by evaluating ENO in a local block.

Examples:

```
"MyFunction"  
  ( IN1 := ... ,  
    IN2 := ... ,  
    OUT1 => #myOut,  
    ENO => #statusFlag ); // PLC tag statusFlag holds the value of E  
NO  
  
"MyFunction"  
  ( IN1 := ...  
    IN2 := ... ,  
    OUT1 => #myOut,  
    ENO => ENO ); // block status flag of "MyFunction"  
                // is stored in the local block  
  
IF ENO = TRUE THEN  
  // execute code only if MyFunction returns true ENO
```

Effect of Ret_Val or Status parameters on ENO

Some instructions, such as the communication instructions or the string conversion instructions, provide an output parameter that contains information about the processing of the instruction. For example, some instructions provide a Ret_Val (return value) parameter, which is typically an Int data type that contains status information in a range from -32768 to +32767. Other instructions provide a Status parameter, which is typically a Word data type that stores status information in a range of hexadecimal values from 16#0000 to 16#FFFF. The numerical value stored in a Ret_Val or a Status parameter determines the state of ENO for that instruction.

- Ret_Val: A value from 0 to 32767 typically sets ENO = 1 (or TRUE). A value from -32768 to -1 typically sets ENO = 0 (or FALSE). To evaluate Ret_Val, change the representation to hexadecimal.
- Status: A value from 16#0000 to 16#7FFF typically sets ENO = 1 (or TRUE). A value from 16#8000 to 16#FFFF typically sets ENO = 0 (or FALSE).

6.6 Protection

Instructions that take more than one scan to execute often provide a Busy parameter (Bool) to signal that the instruction is active but has not completed execution. These instructions often also provide a Done parameter (Bool) and an Error parameter (Bool). Done signals that the instruction was completed without error, and Error signals that the instruction was completed with an error condition.

- When Busy = 1 (or TRUE), ENO = 1 (or TRUE).
- When Done = 1 (or TRUE), ENO = 1 (or TRUE).
- When Error = 1 (or TRUE), ENO = 0 (or FALSE).

See also

OK (Check validity) and NOT_OK (Check invalidity) instructions (Page 228)

6.6 Protection

6.6.1 Access protection for the CPU

The CPU provides four levels of security for restricting access to specific functions. When you configure the security level and password for a CPU, you limit the functions and memory areas that can be accessed without entering a password.

Each level allows certain functions to be accessible without a password. The default condition for the CPU is to have no restriction and no password-protection. To restrict access to a CPU, you configure the properties of the CPU and enter the password.

Entering the password over a network does not compromise the password protection for the CPU. Password protection does not apply to the execution of user program instructions including communication functions. Entering the correct password provides access to all of the functions at that level.

PLC-to-PLC communications (using communication instructions in the code blocks) are not restricted by the security level in the CPU.

Table 6- 4 Security levels for the CPU

| Security level | Access restrictions |
|-----------------------------|---|
| Full access (no protection) | Allows full access without password protection. |
| Read access | Allows HMI access and all forms of PLC-to-PLC communications without password protection. Password is required for modifying (writing to) the CPU and for changing the CPU mode (RUN/STOP). |

| Security level | Access restrictions |
|---------------------------------|--|
| HMI access | Allows HMI access and all forms of PLC-to-PLC communications without password protection. Password is required for reading the data in the CPU, for modifying (writing to) the CPU, and for changing the CPU mode (RUN/STOP). |
| No access (complete protection) | Allows no access without password protection. Password is required for HMI access, reading the data in the CPU, for modifying (writing to) the CPU, and for changing the CPU mode (RUN/STOP) |

Passwords are case-sensitive. To configure the protection level and passwords, follow these steps:

1. In the "Device configuration", select the CPU.
2. In the inspector window, select the "Properties" tab.
3. Select the "Protection" property to select the protection level and to enter passwords.

Protection

Select the access level for the PLC.

| Access level | Access | | | Access permission | |
|---|--------|------|-------|-------------------|--------------|
| | HMI | Read | Write | Password | Confirmation |
| <input type="radio"/> Full access (no protection) | ✓ | ✓ | ✓ | ***** | ***** |
| <input type="radio"/> Read access | ✓ | ✓ | | ***** | ***** |
| <input checked="" type="radio"/> HMI access | ✓ | | | | |
| <input type="radio"/> No access (complete protection) | | | | | |

When you download this configuration to the CPU, the user has HMI access and can access HMI functions without a password. To read data, the user must enter the configured password for "Read access" or the password for "Full access (no protection)". To write data, the user must enter the configured password for "Full access (no protection)".

 **WARNING**

Unauthorized access to a protected CPU

Users with CPU full access privileges have privileges to read and write PLC variables. Regardless of the access level for the CPU, Web server users can have privileges to read and write PLC variables. Unauthorized access to the CPU or changing PLC variables to invalid values could disrupt process operation and could result in death, severe personal injury and/or property damage.

Authorized users can perform operating mode changes, writes to PLC data, and firmware updates. Siemens recommends that you observe the following security practices:

- Password protect CPU access levels and Web server user IDs (Page 604) with strong passwords. Strong passwords are at least eight characters in length, mix letters, numbers, and special characters, are not words that can be found in a dictionary, and are not names or identifiers that can be derived from personal information. Keep the password secret and change it frequently.
- Enable access to the Web server only with the HTTPS protocol.
- Do not extend the default minimum privileges of the Web server "Everybody" user.
- Perform error-checking and range-checking on your variables in your program logic because Web page users can change PLC variables to invalid values.

Connection mechanisms

To access remote connection partners with PUT/GET instructions, the user must also have permission.

By default, the "Permit access with PUT/GET communication" option is not enabled. In this case, read and write access to CPU data is only possible for communication connections that require configuration or programming both for the local CPU and for the communication partner. Access through BSEND/BRCV instructions is possible, for example.

Connections for which the local CPU is only a server (meaning that no configuration/programming of the communication with the communication partner exists at the local CPU), are therefore not possible during operation of the CPU, for example:

- PUT/GET, FETCH/WRITE or FTP access through communication modules
- PUT/GET access from other S7 CPUs
- HMI access through PUT/GET communication

If you want to allow access to CPU data from the client side, that is, you do not want to restrict the communication services of the CPU, follow these steps:

1. Configure the protection access level to be any level other than "No access (complete protection)".
2. Select the "Permit access with PUT/GET communication" check box.



When you download this configuration to the CPU, the CPU permits PUT/GET communication from remote partners

6.6.2 Know-how protection

Know-how protection allows you to prevent one or more code blocks (OB, FB, FC, or DB) in your program from unauthorized access. You create a password to limit access to the code block. The password-protection prevents unauthorized reading or modification of the code block. Without the password, you can read only the following information about the code block:

- Block title, block comment, and block properties
- Transfer parameters (IN, OUT, IN_OUT, Return)
- Call structure of the program
- Global tags in the cross references (without information on the point of use), but local tags are hidden

When you configure a block for "know-how" protection, the code within the block cannot be accessed except after entering the password.

Use the "Properties" task card of the code block to configure the know-how protection for that block. After opening the code block, select "Protection" from Properties.



1. In the Properties for the code block, click the "Protection" button to display the "Know-how protection" dialog.
2. Click the "Define" button to enter the password.



After entering and confirming the password, click "OK".

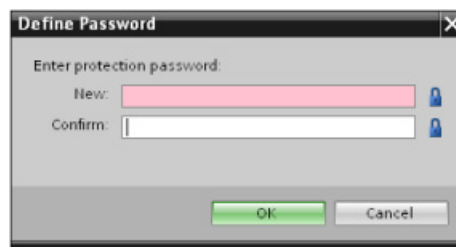

6.6.3 Copy protection

An additional security feature allows you to bind program blocks for use with a specific memory card or CPU. This feature is especially useful for protecting your intellectual property. When you bind a program block to a specific device, you restrict the program or code block for use only with a specific memory card or CPU. This feature allows you to distribute a program or code block electronically (such as over the Internet or through email) or by sending a memory cartridge. Copy protection is available for OBs (Page 172), FBs (Page 175), and FCs (Page 174).

Use the "Properties" task card of the code block to bind the block to a specific CPU or memory card.

1. After opening the code block, select "Protection".



2. From the drop-down list under "Copy protection" task, select the option to bind the code block either to a memory card or to a specific CPU.

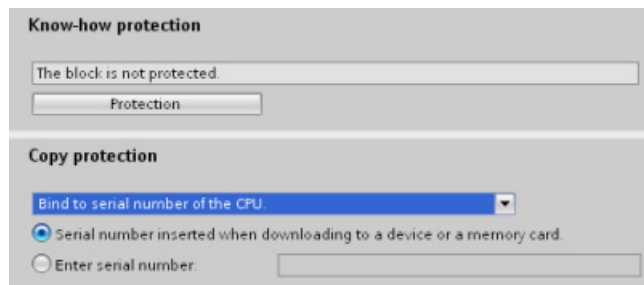

3. Select the type of copy protection and enter the serial number for the memory card or CPU.

Note

The serial number is case-sensitive.

6.7 Downloading the elements of your program

You can download the elements of your project from the programming device to the CPU. When you download a project, the CPU stores the user program (OBs, FCs, FBs and DBs) in permanent memory.

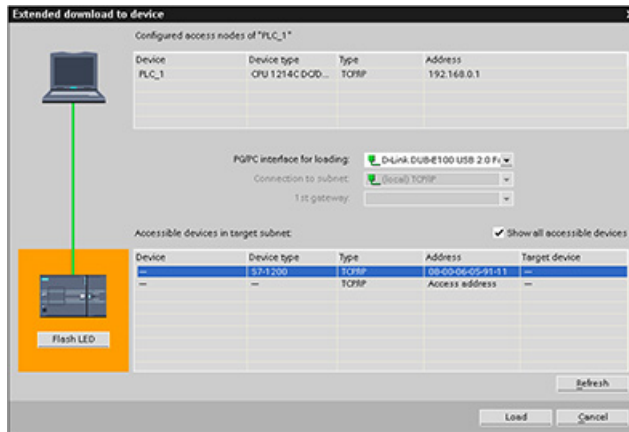

You can download your project from the programming device to your CPU from any of the following locations:

- "Project tree": Right-click the program element, and then click the context-sensitive "Download" selection.
- "Online" menu: Click the "Download to device" selection.
- Toolbar: Click the "Download to device" icon.

Note

Downloading a program does not clear or make any changes to existing values in retentive memory. If you want to clear retentive memory before a download, then reset your CPU to factory settings prior to downloading the program.

You can also download a panel project for the Basic HMI panels (Page 32) from the TIA Portal to a memory card in the S7-1200 CPU.

6.8 Uploading from the CPU

6.8.1 Copying elements of the project

You can also copy the program blocks from an online CPU or a memory card attached to your programming device.

Prepare the offline project for the copied program blocks:

1. Add a CPU device that matches the online CPU.
2. Expand the CPU node once so that the "Program blocks" folder is visible.

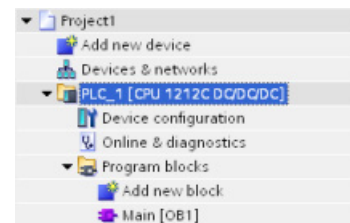

To upload the program blocks from the online CPU to the offline project, follow these steps:

1. Click the "Program blocks" folder in the offline project.
2. Click the "Go online" button.
3. Click the "Upload" button.
4. Confirm your decision from the Upload dialog (Page 786).

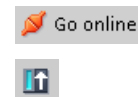

As an alternative to the previous method, follow these steps:

1. From the project navigator, expand the node for "Online access" to select the program blocks in the online CPU:
2. Expand the node for the network, and double click "Update accessible devices".
3. Expand the node for the CPU.
4. Drag the "Program blocks" folder from the online CPU and drop the folder into the "Program blocks" folder of your offline project.
5. In the "Upload preview" dialog, select the box for "Continue", and then click the "Upload from device" button.

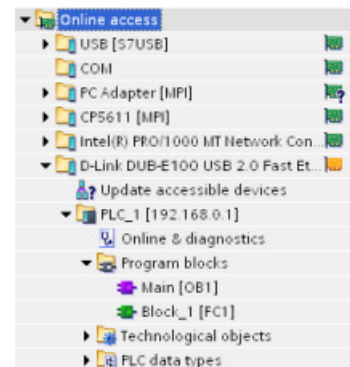

When the upload is complete, all of the program blocks, technology blocks, and tags will be displayed in the offline area.

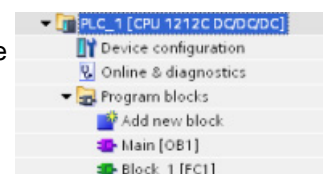

Note

You can copy the program blocks from the online CPU to an existing program. The "Program-blocks" folder of the offline project does not have to be empty. However, the existing program will be deleted and replaced by the user program from the online CPU.

6.8.2 Using the compare function

You can use the "Compare" editor (Page 794) in STEP 7 to find differences between the online and offline projects. You might find this useful prior to uploading from the CPU.

6.9 Debugging and testing the program

6.9.1 Monitor and modify data in the CPU

As shown in the following table, you can monitor and modify values in the online CPU.

Table 6- 5 Monitoring and modifying data with STEP 7

| Editor | Monitor | Modify | Force |
|----------------|---------|--------|-------|
| Watch table | Yes | Yes | No |
| Force table | Yes | No | Yes |
| Program editor | Yes | Yes | No |
| Tag table | Yes | No | No |
| DB editor | Yes | No | No |

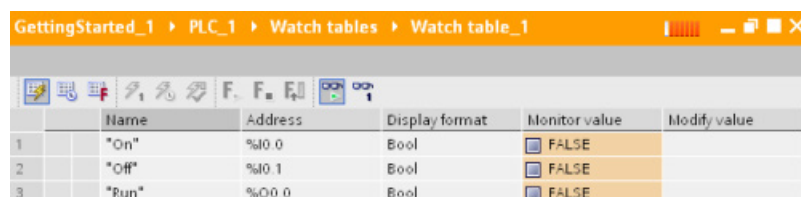

Monitoring with a watch table

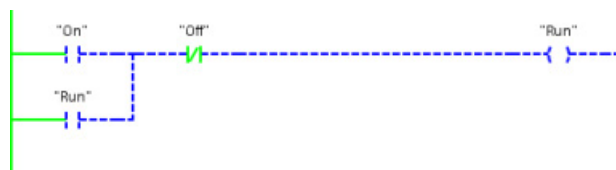

Monitoring with the LAD editor

Refer to the "Online and diagnostics" chapter for more information about monitoring and modifying data in the CPU (Page 795).

6.9.2 Watch tables and force tables

You use "watch tables" for monitoring and modifying the values of a user program being executed by the online CPU. You can create and save different watch tables in your project to support a variety of test environments. This allows you to reproduce tests during commissioning or for service and maintenance purposes.

With a watch table, you can monitor and interact with the CPU as it executes the user program. You can display or change values not only for the tags of the code blocks and data blocks, but also for the memory areas of the CPU, including the inputs and outputs (I and Q), peripheral inputs (I:P), bit memory (M), and data blocks (DB).

With the watch table, you can enable the physical outputs (Q:P) of a CPU in STOP mode. For example, you can assign specific values to the outputs when testing the wiring for the CPU.

STEP 7 also provides a force table for "forcing" a tag to a specific value. For more information about forcing, see the section on forcing values in the CPU (Page 802) in the "Online and Diagnostics" chapter.

Note

The force values are stored in the CPU and not in the watch table.

You cannot force an input (or "I" address). However, you can force a peripheral input. To force a peripheral input, append a ":P" to the address (for example: "On:P").

STEP 7 also provides the capability of tracing and recording program variables based on trigger conditions (Page 813).

6.9.3 Cross reference to show usage

The Inspector window displays cross-reference information about how a selected object is used throughout the complete project, such as the user program, the CPU and any HMI devices. The "Cross-reference" tab displays the instances where a selected object is being used and the other objects using it. The Inspector window also includes blocks which are only available online in the cross-references. To display the cross-references, select the "Show cross-references" command. (In the Project view, find the cross references in the "Tools" menu.)

Note

You do not have to close the editor to see the cross-reference information.

You can sort the entries in the cross-reference. The cross-reference list provides an overview of the use of memory addresses and tags within the user program.

- When creating and changing a program, you retain an overview of the operands, tags and block calls you have used.
- From the cross-references, you can jump directly to the point of use of operands and tags.
- During a program test or when troubleshooting, you are notified about which memory location is being processed by which command in which block, which tag is being used in which screen, and which block is called by which other block.

Table 6- 6 Elements of the cross reference

| Column | Description |
|----------|---|
| Object | Name of the object that uses the lower-level objects or that is being used by the lower-level objects |
| Quantity | Number of uses |
| Location | Each location of use, for example, network |
| Property | Special properties of referenced objects, for example, the tag names in multi-instance declarations |
| as | Shows additional information about the object, such as whether an instance DB is used as template or as a multiple instance |
| Access | Type of access, whether access to the operand is read access (R) and/or write access (W) |
| Address | Address of the operand |
| Type | Information on the type and language used to create the object |
| Path | Path of object in project tree |

6.9.4 Call structure to examine the calling hierarchy

The call structure describes the call hierarchy of the block within your user program. It provides an overview of the blocks used, calls to other blocks, the relationships between blocks, the data requirements for each block, and the status of the blocks. You can open the program editor and edit blocks from the call structure.

Displaying the call structure provides you with a list of the blocks used in the user program. STEP 7 highlights the first level of the call structure and displays any blocks that are not called by any other block in the program. The first level of the call structure displays the OBs and any FCs, FBs, and DBs that are not called by an OB. If a code block calls another block, the called block is shown as an indentation under the calling block. The call structure only displays those blocks that are called by a code block.

You can selectively display only the blocks causing conflicts within the call structure. The following conditions cause conflicts:

- Blocks that execute any calls with older or newer code time stamps
- Blocks that call a block with modified interface
- Blocks that use a tag with modified address and/or data type
- Blocks that are called neither directly nor indirectly by an OB
- Blocks that call a non-existent or missing block

You can group several block calls and data blocks as a group. You use a drop-down list to see the links to the various call locations.

You can also perform a consistency check to show time stamp conflicts. Changing the time stamp of a block during or after the program is generated can lead to time stamp conflicts, which in turn cause inconsistencies among the blocks that are calling and being called.

- Most time stamp and interface conflicts can be corrected by recompiling the code blocks.
- If compilation fails to clear up inconsistencies, use the link in the "Details" column to go to the source of the problem in the program editor. You can then manually eliminate any inconsistencies.
- Any blocks marked in red must be recompiled.

Basic instructions

7.1 Bit logic operations

7.1.1 Bit logic instructions

LAD and FBD are very effective for handling Boolean logic. While SCL is especially effective for complex mathematical computation and for project control structures, you can use SCL for Boolean logic.

LAD contacts

Table 7- 1 Normally open and normally closed contacts



| LAD | SCL | Description |
|---|--|---|
| "IN"  | <pre>IF in THEN Statement; ELSE Statement; END_IF;</pre> | Normally open and normally closed contacts: You can connect contacts to other contacts and create your own combination logic. If the input bit you specify uses memory identifier I (input) or Q (output), then the bit value is read from the process-image register. The physical contact signals in your control process are wired to I terminals on the PLC. The CPU scans the wired input signals and continuously updates the corresponding state values in the process-image input register. |
| "IN"  | <pre>IF NOT (in) THEN Statement; ELSE Statement; END_IF;</pre> | You can perform an immediate read of a physical input using ":P" following the I offset (example: "%I3.4:P"). For an immediate read, the bit data values are read directly from the physical input instead of the process image. An immediate read does not update the process image. |

Table 7- 2 Data types for the parameters

| Parameter | Data type | Description |
|-----------|-----------|--------------|
| IN | Bool | Assigned bit |

- The Normally Open contact is closed (ON) when the assigned bit value is equal to 1.
- The Normally Closed contact is closed (ON) when the assigned bit value is equal to 0.
- Contacts connected in series create AND logic networks.
- Contacts connected in parallel create OR logic networks.

FBD AND, OR, and XOR boxes

In FBD programming, LAD contact networks are transformed into AND (&), OR (>=1), and exclusive OR (x) box networks where you can specify bit values for the box inputs and outputs. You may also connect to other logic boxes and create your own logic combinations. After the box is placed in your network, you can drag the "Insert input" tool from the "Favorites" toolbar or instruction tree and then drop it onto the input side of the box to add more inputs. You can also right-click on the box input connector and select "Insert input".

Box inputs and outputs can be connected to another logic box, or you can enter a bit address or bit symbol name for an unconnected input. When the box instruction is executed, the current input states are applied to the binary box logic and, if true, the box output will be true.

Table 7- 3 AND, OR, and XOR boxes

| FBD | SCL ¹ | Description |
|-----|--------------------------------|---|
| | <pre>out := in1 AND in2;</pre> | All inputs of an AND box must be TRUE for the output to be TRUE. |
| | <pre>out := in1 OR in2;</pre> | Any input of an OR box must be TRUE for the output to be TRUE. |
| | <pre>out := in1 XOR in2;</pre> | An odd number of the inputs of an XOR box must be TRUE for the output to be TRUE. |

¹ For SCL: You must assign the result of the operation to a variable to be used for another statement.

Table 7- 4 Data types for the parameters

| Parameter | Data type | Description |
|-----------|-----------|-------------|
| IN1, IN2 | Bool | Input bit |

NOT logic inverter

Table 7- 5 Invert RLO (Result of Logic Operation)

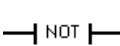
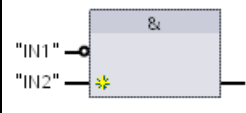
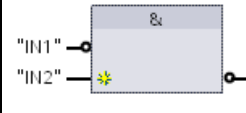
| LAD | FBD | SCL | Description |
|---|--|------------|--|
|  |   | NOT | <p>For FBD programming, you can drag the "Negate binary input" tool from the "Favorites" toolbar or instruction tree and then drop it on an input or output to create a logic inverter on that box connector.</p> <p>The LAD NOT contact inverts the logical state of power flow input.</p> <ul style="list-style-type: none"> • If there is no power flow into the NOT contact, then there is power flow out. • If there is power flow into the NOT contact, then there is no power flow out. |

Output coil and assignment box

The coil output instruction writes a value for an output bit. If the output bit you specify uses memory identifier Q, then the CPU turns the output bit in the process-image register on or off, setting the specified bit equal to power flow status. The output signals for your control actuators are wired to the Q terminals of the CPU. In RUN mode, the CPU system continuously scans your input signals, processes the input states according to your program logic, and then reacts by setting new output state values in the process-image output register. The CPU system transfers the new output state reaction that is stored in the process-image register, to the wired output terminals.

Table 7- 6 Assignment and negate assignment

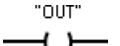
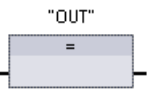
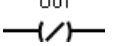
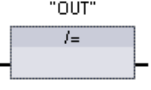
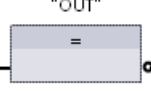
| LAD | FBD | SCL | Description |
|---|---|---|--|
|  |  | <pre>out := <Boolean expression>;</pre> | <p>In FBD programming, LAD coils are transformed into assignment (= and /=) boxes where you specify a bit address for the box output. Box inputs and outputs can be connected to other box logic or you can enter a bit address.</p> <p>You can specify an immediate write of a physical output using ":P" following the Q offset (example: "%Q3.4:P"). For an immediate write, the bit data values are written to the process image output and directly to physical output.</p> |
|  |  | <pre>out := NOT <Boolean expression>;</pre> | |
| |  | | |

7.1 Bit logic operations

Table 7- 7 Data types for the parameters

| Parameter | Data type | Description |
|-----------|-----------|--------------|
| OUT | Bool | Assigned bit |

- If there is power flow through an output coil or an FBD "=" box is enabled, then the output bit is set to 1.
- If there is no power flow through an output coil or an FBD "=" assignment box is not enabled, then the output bit is set to 0.
- If there is power flow through an inverted output coil or an FBD "/=" box is enabled, then the output bit is set to 0.
- If there is no power flow through an inverted output coil or an FBD "/=" box is not enabled, then the output bit is set to 1.

7.1.2 Set and reset instructions

Set and Reset 1 bit

Table 7- 8 S and R instructions

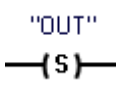
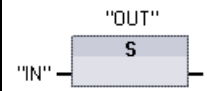
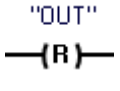
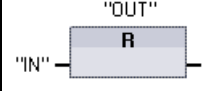
| LAD | FBD | SCL | Description |
|---|---|---------------|--|
|  |  | Not available | Set output: When S (Set) is activated, then the data value at the OUT address is set to 1. When S is not activated, OUT is not changed. |
|  |  | Not available | Reset output: When R (Reset) is activated, then the data value at the OUT address is set to 0. When R is not activated, OUT is not changed. |



- 1 For LAD and FBD: These instructions can be placed anywhere in the network.
- 2 For SCL: You must write code to replicate this function within your application.

Table 7- 9 Data types for the parameters

| Parameter | Data type | Description |
|---------------------------------------|-----------|--|
| IN (or connect to contact/gate logic) | Bool | Bit tag of location to be monitored |
| OUT | Bool | Bit tag of location to be set or reset |

Set and Reset Bit Field

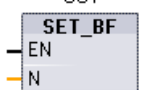
Table 7- 10 SET_BF and RESET_BF instructions

| LAD ¹ | FBD | SCL | Description |
|---|---|---------------|--|
|  |  | Not available | Set bit field: When SET_BF is activated, a data value of 1 is assigned to "n" bits starting at address tag OUT. When SET_BF is not activated, OUT is not changed. |
|  |  | Not available | Reset bit field: RESET_BF writes a data value of 0 to "n" bits starting at address tag OUT. When RESET_BF is not activated, OUT is not changed. |

- 1 For LAD and FBD: These instructions must be the right-most instruction in a branch.
- 2 For SCL: You must write code to replicate this function within your application.

Table 7- 11 Data types for the parameters

| Parameter | Data type | Description |
|-----------|-----------------|---|
| OUT | Bool | Starting element of a bit field to be set or reset (Example: #MyArray[3]) |
| n | Constant (UInt) | Number of bits to write |

Set-dominant and Reset-dominant flip-flops

Table 7- 12 RS and SR instructions

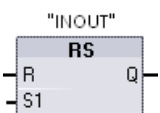
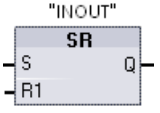
| LAD / FBD | SCL | Description |
|---|---------------|--|
|  | Not available | Reset/set flip-flop: RS is a set dominant latch where the set dominates. If the set (S1) and reset (R) signals are both true, the value at address INOUT will be 1. |
|  | Not available | Set/reset flip-flop: SR is a reset dominant latch where the reset dominates. If the set (S) and reset (R1) signals are both true, the value at address INOUT will be 0. |

- 1 For LAD and FBD: These instructions must be the right-most instruction in a branch.
- 2 For SCL: You must write code to replicate this function within your application.

Table 7- 13 Data types for the parameters

| Parameter | Data type | Description |
|-----------|-----------|------------------------------------|
| S, S1 | Bool | Set input; 1 indicates dominance |
| R, R1 | Bool | Reset input; 1 indicates dominance |
| INOUT | Bool | Assigned bit tag "INOUT" |
| Q | Bool | Follows state of "INOUT" bit |

The "INOUT" tag assigns the bit address that is set or reset. The optional output Q follows the signal state of the "INOUT" address.

| Instruction | S1 | R | "INOUT" bit |
|-------------|----------|-----------|----------------|
| RS | 0 | 0 | Previous state |
| | 0 | 1 | 0 |
| | 1 | 0 | 1 |
| | 1 | 1 | 1 |
| SR | S | R1 | |
| | 0 | 0 | Previous state |
| | 0 | 1 | 0 |
| | 1 | 0 | 1 |
| | 1 | 1 | 0 |

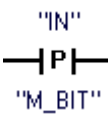
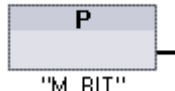
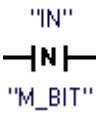
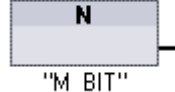
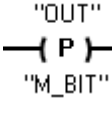
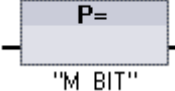
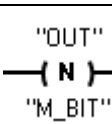
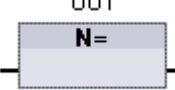

7.1.3 Positive and negative edge instructions

Table 7- 14 Positive and negative transition detection

| LAD | FBD | SCL | Description |
|---|---|----------------------------|--|
|  |  | Not available ¹ | <p>Scan operand for positive signal edge.</p> <p>LAD: The state of this contact is TRUE when a positive transition (OFF-to-ON) is detected on the assigned "IN" bit. The contact logic state is then combined with the power flow in state to set the power flow out state. The P contact can be located anywhere in the network except the end of a branch.</p> <p>FBD: The output logic state is TRUE when a positive transition (OFF-to-ON) is detected on the assigned input bit. The P box can only be located at the beginning of a branch.</p> |
|  |  | Not available ¹ | <p>Scan operand for negative signal edge.</p> <p>LAD: The state of this contact is TRUE when a negative transition (ON-to-OFF) is detected on the assigned input bit. The contact logic state is then combined with the power flow in state to set the power flow out state. The N contact can be located anywhere in the network except the end of a branch.</p> <p>FBD: The output logic state is TRUE when a negative transition (ON-to-OFF) is detected on the assigned input bit. The N box can only be located at the beginning of a branch.</p> |
|  |  | Not available ¹ | <p>Set operand on positive signal edge.</p> <p>LAD: The assigned bit "OUT" is TRUE when a positive transition (OFF-to-ON) is detected on the power flow entering the coil. The power flow in state always passes through the coil as the power flow out state. The P coil can be located anywhere in the network.</p> <p>FBD: The assigned bit "OUT" is TRUE when a positive transition (OFF-to-ON) is detected on the logic state at the box input connection or on the input bit assignment if the box is located at the start of a branch. The input logic state always passes through the box as the output logic state. The P= box can be located anywhere in the branch.</p> |
|  |  | Not available ¹ | <p>Set operand on negative signal edge.</p> <p>LAD: The assigned bit "OUT" is TRUE when a negative transition (ON-to-OFF) is detected on the power flow entering the coil. The power flow in state always passes through the coil as the power flow out state. The N coil can be located anywhere in the network.</p> <p>FBD: The assigned bit "OUT" is TRUE when a negative transition (ON-to-OFF) is detected on the logic state at the box input connection or on the input bit assignment if the box is located at the start of a branch. The input logic state always passes through the box as the output logic state. The N= box can be located anywhere in the branch.</p> |

¹ For SCL: You must write code to replicate this function within your application.

Table 7- 15 P_TRIG and N_TRIG

| LAD / FBD | SCL | Description |
|---|----------------------------|--|
|  | Not available ¹ | <p>Scan RLO (result of logic operation) for positive signal edge.</p> <p>The Q output power flow or logic state is TRUE when a positive transition (OFF-to-ON) is detected on the CLK input state (FBD) or CLK power flow in (LAD).</p> <p>In LAD, the P_TRIG instruction cannot be located at the beginning or end of a network. In FBD, the P_TRIG instruction can be located anywhere except the end of a branch.</p> |
|  | Not available ¹ | <p>Scan RLO for negative signal edge.</p> <p>The Q output power flow or logic state is TRUE when a negative transition (ON-to-OFF) is detected on the CLK input state (FBD) or CLK power flow in (LAD).</p> <p>In LAD, the N_TRIG instruction cannot be located at the beginning or end of a network. In FBD, the N_TRIG instruction can be located anywhere except the end of a branch.</p> |

¹ For SCL: You must write code to replicate this function within your application.

Table 7- 16 R_TRIG and F_TRIG instructions

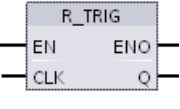
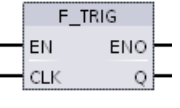
| LAD / FBD | SCL | Description |
|--|---------------------------------------|---|
| <p>"R_TRIG_DB"</p>  | "R_TRIG_DB" (CLK:= _in_, Q=> _out_ | <p>Set tag on positive signal edge.</p> <p>The assigned instance DB is used to store the previous state of the CLK input. The Q output power flow or logic state is TRUE when a positive transition (OFF-to-ON) is detected on the CLK input state (FBD) or CLK power flow in (LAD).</p> <p>In LAD, the R_TRIG instruction cannot be located at the beginning or end of a network. In FBD, the R_TRIG instruction can be located anywhere except the end of a branch.</p> |
| <p>"F_TRIG_DB_1"</p>  | "F_TRIG_DB" (CLK:= _in_, Q=> _out_ | <p>Set tag on negative signal edge.</p> <p>The assigned instance DB is used to store the previous state of the CLK input. The Q output power flow or logic state is TRUE when a negative transition (ON-to-OFF) is detected on the CLK input state (FBD) or CLK power flow in (LAD).</p> <p>In LAD, the F_TRIG instruction cannot be located at the beginning or end of a network. In FBD, the F_TRIG instruction can be located anywhere except the end of a branch.</p> |

For R_TRIG and F_TRIG, when you insert the instruction in the program, the "Call options" dialog opens automatically. In this dialog you can assign whether the edge memory bit is stored in its own data block (single instance) or as a local tag (multiple instance) in the block interface. If you create a separate data block, you will find it in the project tree in the "Program resources" folder under "Program blocks > System blocks".

Table 7- 17 Data types for the parameters (P and N contacts/coils, P=, N=, P_TRIG and N_TRIG)

| Parameter | Data type | Description |
|-----------|-----------|--|
| M_BIT | Bool | Memory bit in which the previous state of the input is saved |
| IN | Bool | Input bit whose transition edge is detected |
| OUT | Bool | Output bit which indicates a transition edge was detected |
| CLK | Bool | Power flow or input bit whose transition edge is detected |
| Q | Bool | Output which indicates an edge was detected |

All edge instructions use a memory bit (M_BIT: P/N contacts/coils, P_TRIG/N_TRIG) or (instance DB bit: R_TRIG, F_TRIG) to store the previous state of the monitored input signal. An edge is detected by comparing the state of the input with the previous state. If the states indicate a change of the input in the direction of interest, then an edge is reported by writing the output TRUE. Otherwise, the output is written to FALSE.

Note

Edge instructions evaluate the input and memory-bit values each time they are executed, including the first execution. You must account for the initial states of the input and memory bit in your program design either to allow or to avoid edge detection on the first scan.

Because the memory bit must be maintained from one execution to the next, you should use a unique bit for each edge instruction, and you should not use this bit any other place in your program. You should also avoid temporary memory and memory that can be affected by other system functions, such as an I/O update. Use only M, global DB, or Static memory (in an instance DB) for M_BIT memory assignments.

7.2 Timer operations

You use the timer instructions to create programmed time delays. The number of timers that you can use in your user program is limited only by the amount of memory in the CPU. Each timer uses a 16 byte IEC_Timer data type DB structure to store timer data that is specified at the top of the box or coil instruction. STEP 7 automatically creates the DB when you insert the instruction.

Table 7- 18 Timer instructions

| LAD / FBD boxes | LAD coils | SCL | Description |
|---|--|--|---|
| <p>IEC_Timer_0 TP Time IN Q PT ET</p> | <p>TP_DB (TP) "PRESET_Tag"</p> | <pre>"IEC_Timer_0_DB".TP (IN:=_bool_in_, PT:=_time_in_, Q=>_bool_out_, ET=>_time_out_);</pre> | The TP timer generates a pulse with a preset width time. |
| <p>IEC_Timer_1 TON Time IN Q PT ET</p> | <p>TON_DB (TON) "PRESET_Tag"</p> | <pre>"IEC_Timer_0_DB".TON (IN:=_bool_in_, PT:=_time_in_, Q=>_bool_out_, ET=>_time_out_);</pre> | The TON timer sets output Q to ON after a preset time delay. |
| <p>IEC_Timer_2 TOF Time IN Q PT ET</p> | <p>TOF_DB (TOF) "PRESET_Tag"</p> | <pre>"IEC_Timer_0_DB".TOF (IN:=_bool_in_, PT:=_time_in_, Q=>_bool_out_, ET=>_time_out_);</pre> | The TOF timer resets output Q to OFF after a preset time delay. |
| <p>IEC_Timer_3 TONR Time IN Q R ET PT</p> | <p>TONR_DB (TONR) "PRESET_Tag"</p> | <pre>"IEC_Timer_0_DB".TONR (IN:=_bool_in_, R:=_bool_in_, PT:=_time_in_, Q=>_bool_out_, ET=>_time_out_);</pre> | The TONR timer sets output Q to ON after a preset time delay. Elapsed time is accumulated over multiple timing periods until the R input is used to reset the elapsed time. |
| <p>FBD only:</p> <p>PT PT</p> | <p>TON_DB (PT) "PRESET_Tag"</p> | (No SCL equivalent) | The PT (Preset timer) coil loads a new PRESET time value in the specified IEC_Timer. |
| <p>FBD only:</p> <p>RT</p> | <p>TON_DB (RT)</p> | (No SCL equivalent) | The RT (Reset timer) coil resets the specified IEC_Timer. |

¹ STEP 7 automatically creates the DB when you insert the instruction.

² In the SCL examples, "IEC_Timer_0_DB" is the name of the instance DB.

Table 7- 19 Data types for the parameters

| Parameter | Data type | Description |
|-------------------------------|-----------|--|
| Box: IN Coil: Power flow | Bool | TP, TON, and TONR: Box: 0=Disable timer, 1=Enable timer Coil: No power flow=Disable timer, Power flow=Enable timer TOF: Box: 0=Enable timer, 1=Disable timer Coil: No power flow=Enable timer, Power flow=Disable timer |
| R | Bool | TONR box only: 0=No reset 1= Reset elapsed time and Q bit to 0 |
| Box: PT Coil: "PRESET_Tag" | Time | Timer box or coil: Preset time input |
| Box: Q Coil: DBdata.Q | Bool | Timer box: Q box output or Q bit in the timer DB data Timer coil: you can only address the Q bit in the timer DB data |
| Box: ET Coil: DBdata.ET | Time | Timer box: ET (elapsed time) box output or ET time value in the timer DB data Timer coil: you can only address the ET time value in the timer DB data. |

Table 7- 20 Effect of value changes in the PT and IN parameters

| Timer | Changes in the PT and IN box parameters and the corresponding coil parameters |
|-------|---|
| TP | <ul style="list-style-type: none"> Changing PT has no effect while the timer runs. Changing IN has no effect while the timer runs. |
| TON | <ul style="list-style-type: none"> Changing PT has no effect while the timer runs. Changing IN to FALSE, while the timer runs, resets and stops the timer. |
| TOF | <ul style="list-style-type: none"> Changing PT has no effect while the timer runs. Changing IN to TRUE, while the timer runs, resets and stops the timer. |
| TONR | <ul style="list-style-type: none"> Changing PT has no effect while the timer runs, but has an effect when the timer resumes. Changing IN to FALSE, while the timer runs, stops the timer but does not reset the timer. Changing IN back to TRUE will cause the timer to start timing from the accumulated time value. |

PT (preset time) and ET (elapsed time) values are stored in the specified IEC_TIMER DB data as signed double integers that represent milliseconds of time. TIME data uses the T# identifier and can be entered as a simple time unit (T#200ms or 200) and as compound time units like T#2s_200ms.

Table 7- 21 Size and range of the TIME data type

| Data type | Size | Valid number ranges ¹ |
|-----------|------------------------------|---|
| TIME | 32 bits, stored as DInt data | T#-24d_20h_31m_23s_648ms to T#24d_20h_31m_23s_647ms Stored as -2,147,483,648 ms to +2,147,483,647 ms |

¹ The negative range of the TIME data type shown above cannot be used with the timer instructions. Negative PT (preset time) values are set to zero when the timer instruction is executed. ET (elapsed time) is always a positive value.

Timer coil example

The -(TP)-, -(TON)-, -(TOF)-, and -(TONR)- timer coils must be the last instruction in a LAD network. As shown in the timer example, a contact instruction in a subsequent network evaluates the Q bit in a timer coil's IEC_Timer DB data. Likewise, you must address the ELAPSED element in the IEC_timer DB data if you want to use the elapsed time value in your program.

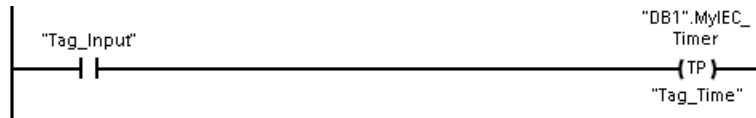

The pulse timer is started on a 0 to 1 transition of the Tag_Input bit value. The timer runs for the time specified by Tag_Time time value.

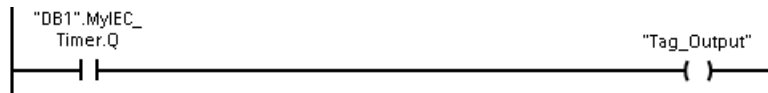

As long as the timer runs, the state of DB1.MyIEC_Timer.Q=1 and the Tag_Output value=1. When the Tag_Time value has elapsed, then DB1.MyIEC_Timer.Q=0 and the Tag_Output value=0.

Reset timer -(RT)- and Preset timer -(PT)- coils

These coil instructions can be used with box or coil timers and can be placed in a mid-line position. The coil output power flow status is always the same as the coil input status. When the -(RT)- coil is activated, the ELAPSED time element of the specified IEC_Timer DB data is reset to 0. When the -(PT)- coil is activated, the PRESET time element of the specified IEC_Timer DB data is loaded with the assigned time-duration value..

Note

When you place timer instructions in an FB, you can select the "Multi-instance data block" option. The timer structure names can be different with separate data structures, but the timer data is contained in a single data block and does not require a separate data block for each timer. This reduces the processing time and data storage necessary for handling the timers. There is no interaction between the timer data structures in the shared multi-instance DB.

Operation of the timers

Table 7- 22 Types of IEC timers

| Timer | Timing diagram |
|---|----------------|
| <p>TP: Generate pulse</p> <p>The TP timer generates a pulse with a preset width time.</p> | |
| <p>TON: Generate ON-delay</p> <p>The TON timer sets output Q to ON after a preset time delay.</p> | |
| <p>TOF: Generate OFF-delay</p> <p>The TOF timer resets output Q to OFF after a preset time delay.</p> | |
| <p>TONR: Time accumulator</p> <p>The TONR timer sets output Q to ON after a preset time delay. Elapsed time is accumulated over multiple timing periods until the R input is used to reset the elapsed time.</p> | |

Note

In the CPU, no dedicated resource is allocated to any specific timer instruction. Instead, each timer utilizes its own timer structure in DB memory and a continuously-running internal CPU timer to perform timing.

When a timer is started due to an edge change on the input of a TP, TON, TOF, or TONR instruction, the value of the continuously-running internal CPU timer is copied into the START member of the DB structure allocated for this timer instruction. This start value remains unchanged while the timer continues to run, and is used later each time the timer is updated. Each time the timer is started, a new start value is loaded into the timer structure from the internal CPU timer.

When a timer is updated, the start value described above is subtracted from the current value of the internal CPU timer to determine the elapsed time. The elapsed time is then compared with the preset to determine the state of the timer Q bit. The ELAPSED and Q members are then updated in the DB structure allocated for this timer. Note that the elapsed time is clamped at the preset value (the timer does not continue to accumulate elapsed time after the preset is reached).

A timer update is performed when and only when:

- A timer instruction (TP, TON, TOF, or TONR) is executed
- The "ELAPSED" member of the timer structure in DB is referenced directly by an instruction
- The "Q" member of the timer structure in DB is referenced directly by an instruction

Timer programming

The following consequences of timer operation should be considered when planning and creating your user program:

- You can have multiple updates of a timer in the same scan. The timer is updated each time the timer instruction (TP, TON, TOF, TONR) is executed and each time the ELAPSED or Q member of the timer structure is used as a parameter of another executed instruction. This is an advantage if you want the latest time data (essentially an immediate read of the timer). However, if you desire to have consistent values throughout a program scan, then place your timer instruction prior to all other instructions that need these values, and use tags from the Q and ET outputs of the timer instruction instead of the ELAPSED and Q members of the timer DB structure.
- You can have scans during which no update of a timer occurs. It is possible to start your timer in a function, and then cease to call that function again for one or more scans. If no other instructions are executed which reference the ELAPSED or Q members of the timer structure, then the timer will not be updated. A new update will not occur until either the timer instruction is executed again or some other instruction is executed using ELAPSED or Q from the timer structure as a parameter.
- Although not typical, you can assign the same DB timer structure to multiple timer instructions. In general, to avoid unexpected interaction, you should only use one timer instruction (TP, TON, TOF, TONR) per DB timer structure.
- Self-resetting timers are useful to trigger actions that need to occur periodically. Typically, self-resetting timers are created by placing a normally-closed contact which references the timer bit in front of the timer instruction. This timer network is typically located above one or more dependent networks that use the timer bit to trigger actions. When the timer expires (elapsed time reaches preset value), the timer bit is ON for one scan, allowing the dependent network logic controlled by the timer bit to execute. Upon the next execution of the timer network, the normally closed contact is OFF, thus resetting the timer and clearing the timer bit. The next scan, the normally closed contact is ON, thus restarting the timer. When creating self-resetting timers such as this, do not use the "Q" member of the timer DB structure as the parameter for the normally-closed contact in front of the timer instruction. Instead, use the tag connected to the "Q" output of the timer instruction for this purpose. The reason to avoid accessing the Q member of the timer DB structure is because this causes an update to the timer and if the timer is updated due to the normally closed contact, then the contact will reset the timer instruction immediately. The Q output of the timer instruction will not be ON for the one scan and the dependent networks will not execute.

Time data retention after a RUN-STOP-RUN transition or a CPU power cycle

If a run mode session is ended with stop mode or a CPU power cycle and a new run mode session is started, then the timer data stored in the previous run mode session is lost, unless the timer data structure is specified as retentive (TP, TON, TOF, and TONR timers).

When you accept the defaults in the call options dialog after you place a timer instruction in the program editor, you are automatically assigned an instance DB which **cannot be made retentive**. To make your timer data retentive, you must either use a global DB or a Multi-instance DB.

Assign a global DB to store timer data as retentive data

This option works regardless of where the timer is placed (OB, FC, or FB).

1. Create a global DB:
 - Double-click "Add new block" from the Project tree
 - Click the data block (DB) icon
 - For the Type, choose global DB
 - If you want to be able to select individual data elements in this DB as retentive, be sure the DB type "Optimized" box is checked. The other DB type option "Standard - compatible with S7-300/400" only allows setting all DB data elements retentive or none retentive.
 - Click OK
2. Add timer structure(s) to the DB:
 - In the new global DB, add a new static tag using data type IEC_Timer.
 - In the "Retain" column, check the box so that this structure will be retentive.
 - Repeat this process to create structures for all the timers that you want to store in this DB. You can either place each timer structure in a unique global DB, or you can place multiple timer structures into the same global DB. You can also place other static tags besides timers in this global DB. Placing multiple timer structures into the same global DB allows you to reduce your overall number of blocks.
 - Rename the timer structures if desired.
3. Open the program block for editing where you want to place a retentive timer (OB, FC, or FB).
4. Place the timer instruction at the desired location.
5. When the call options dialog appears, click the cancel button.
6. On the top of the new timer instruction, type the name (do not use the helper to browse) of the global DB and timer structure that you created above (example: "Data_block_3.Static_1").

Assign a multi-instance DB to store timer data as retentive data

This option only works if you place the timer in an FB.

This option depends upon whether the FB properties specify "Optimized block access" (allows symbolic access only). To verify how the access attribute is configured for an existing FB, right-click on the FB in the Project tree, choose properties, and then choose Attributes.

If the FB specifies "Optimized block access" (allows symbolic access only):

1. Open the FB for edit.
2. Place the timer instruction at the desired location in the FB.
3. When the Call options dialog appears, click the Multi instance icon. The Multi Instance option is only available if the instruction is being placed into an FB.
4. In the Call options dialog, rename the timer if desired.
5. Click OK. The timer instruction appears in the editor, and the IEC_TIMER structure appears in the FB Interface under Static.
6. If necessary, open the FB interface editor (may have to click on the small arrow to expand the view).
7. Under Static, locate the timer structure that was just created for you.
8. In the Retain column for this timer structure, change the selection to "Retain". Whenever this FB is called later from another program block, an instance DB will be created with this interface definition which contains the timer structure marked as retentive.

If the FB does not specify "Optimized block access", then the block access type is standard, which is compatible with S7-300/400 classic configurations and allows symbolic and direct access. To assign a multi-instance to a standard block access FB, follow these steps:

1. Open the FB for edit.
2. Place the timer instruction at the desired location in the FB.
3. When the Call options dialog appears, click on the multi instance icon. The multi instance option is only available if the instruction is being placed into an FB.
4. In the Call options dialog, rename the timer if desired.
5. Click OK. The timer instruction appears in the editor, and the IEC_TIMER structure appears in the FB Interface under Static.
6. Open the block that will use this FB.
7. Place this FB at the desired location. Doing so results in the creation of an instance data block for this FB.
8. Open the instance data block created when you placed the FB in the editor.
9. Under Static, locate the timer structure of interest. In the Retain column for this timer structure, check the box to make this structure retentive.

7.3 Counter operations

Table 7- 23 Counter instructions

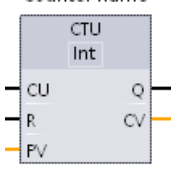
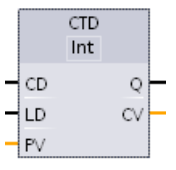
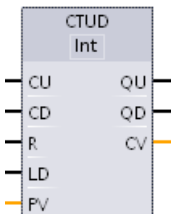
| LAD / FBD | SCL | Description |
|--|--|--|
| <p>"Counter name"</p>  | <pre>"IEC_Counter_0_DB".CTU (CU:=_bool_in, R:=_bool_in, PV:=_int_in, Q=>_bool_out, CV=>_int_out);</pre> | <p>Use the counter instructions to count internal program events and external process events. Each counter uses a structure stored in a data block to maintain counter data. You assign the data block when the counter instruction is placed in the editor.</p> <ul style="list-style-type: none"> • CTU is a count-up counter • CTD is a count-down counter • CTUD is a count-up-and-down counter |
| <p>"Counter name"</p>  | <pre>"IEC_Counter_0_DB".CTD (CD:=_bool_in, LD:=_bool_in, PV:=_int_in, Q=>_bool_out, CV=>_int_out);</pre> | |
| <p>"Counter name"</p>  | <pre>"IEC_Counter_0_DB".CTUD (CU:=_bool_in, CD:=_bool_in, R:=_bool_in, LD:=_bool_in, PV:=_int_in, QU=>_bool_out, QD=>_bool_out, CV=>_int_out);</pre> | |

- 1 For LAD and FBD: Select the count value data type from the drop-down list below the instruction name.
- 2 STEP 7 automatically creates the DB when you insert the instruction.
- 3 In the SCL examples, "IEC_Counter_0_DB" is the name of the instance DB.

Table 7- 24 Data types for the parameters

| Parameter | Data type ¹ | Description |
|----------------|--------------------------------------|--------------------------------------|
| CU, CD | Bool | Count up or count down, by one count |
| R (CTU, CTUD) | Bool | Reset count value to zero |
| LD (CTD, CTUD) | Bool | Load control for preset value |
| PV | SInt, Int, DInt, USInt, UInt, UDIInt | Preset count value |
| Q, QU | Bool | True if CV >= PV |
| QD | Bool | True if CV <= 0 |
| CV | SInt, Int, DInt, USInt, UInt, UDIInt | Current count value |

¹ The numerical range of count values depends on the data type you select. If the count value is an unsigned integer type, you can count down to zero or count up to the range limit. If the count value is a signed integer, you can count down to the negative integer limit and count up to the positive integer limit.

The number of counters that you can use in your user program is limited only by the amount of memory in the CPU. Counters use the following amount of memory:

- For SInt or USInt data types, the counter instruction uses 3 bytes.
- For Int or UInt data types, the counter instruction uses 6 bytes.
- For DInt or UDInt data types, the counter instruction uses 12 bytes.

These instructions use software counters whose maximum counting rate is limited by the execution rate of the OB in which they are placed. The OB that the instructions are placed in must be executed often enough to detect all transitions of the CU or CD inputs. For faster counting operations, see the CTRL_HSC instruction (Page 409).

Note

When you place counter instructions in an FB, you can select the multi-instance DB option, the counter structure names can be different with separate data structures, but the counter data is contained in a single DB and does not require a separate DB for each counter. This reduces the processing time and data storage necessary for the counters. There is no interaction between the counter data structures in the shared multi-instance DB.

Operation of the counters

Table 7- 25 Operation of CTU (count up)

| Counter | Operation |
|--|---|
| <p>The CTU counter counts up by 1 when the value of parameter CU changes from 0 to 1. The CTU timing diagram shows the operation for an unsigned integer count value (where PV = 3).</p> <ul style="list-style-type: none"> • If the value of parameter CV (current count value) is greater than or equal to the value of parameter PV (preset count value), then the counter output parameter Q = 1. • If the value of the reset parameter R changes from 0 to 1, then the current count value is reset to 0. | <p>The timing diagram shows four signals: CU, R, CV, and Q. CU is a square wave with four pulses. R is a single pulse that occurs after the fourth CU pulse. CV starts at 0 and increments by 1 for each rising edge of CU. It reaches 1, 2, 3, and 4. Q is 0 until CV reaches 3, then becomes 1. When R becomes 1, CV resets to 0 and Q becomes 0.</p> |

7.3 Counter operations

Table 7- 26 Operation of CTD (count down)

| Counter | Operation |
|---|-----------|
| <p>The CTD counter counts down by 1 when the value of parameter CD changes from 0 to 1. The CTD timing diagram shows the operation for an unsigned integer count value (where PV = 3).</p> <ul style="list-style-type: none"> • If the value of parameter CV (current count value) is equal to or less than 0, the counter output parameter Q = 1. • If the value of parameter LOAD changes from 0 to 1, the value at parameter PV (preset value) is loaded to the counter as the new CV (current count value). | |

Table 7- 27 Operation of CTUD (count up and down)

| Counter | Operation |
|--|-----------|
| <p>The CTUD counter counts up or down by 1 on the 0 to 1 transition of the count up (CU) or count down (CD) inputs. The CTUD timing diagram shows the operation for an unsigned integer count value (where PV = 4).</p> <ul style="list-style-type: none"> • If the value of parameter CV is equal to or greater than the value of parameter PV, then the counter output parameter QU = 1. • If the value of parameter CV is less than or equal to zero, then the counter output parameter QD = 1. • If the value of parameter LOAD changes from 0 to 1, then the value at parameter PV is loaded to the counter as the new CV. • If the value of the reset parameter R is changes from 0 to 1, the current count value is reset to 0. | |

Counter data retention after a RUN-STOP-RUN transition or a CPU power cycle

If a run mode session is ended with stop mode or a CPU power cycle and a new run mode session is started, then the counter data stored in the previous run mode session is lost, unless the counter data structure is specified as retentive (CTU, CTD, and CTUD counters).

When you accept the defaults in the call options dialog after you place a counter instruction in the program editor, you are automatically assigned an instance DB which **cannot be made retentive**. To make your counter data retentive, you must either use a global DB or a Multi-instance DB.

Assign a global DB to store counter data as retentive data

This option works regardless of where the counter is placed (OB, FC, or FB).

1. Create a global DB:
 - Double-click "Add new block" from the Project tree
 - Click the data block (DB) icon
 - For the Type, choose global DB
 - If you want to be able to select individual items in this DB as retentive, be sure the symbolic-access-only box is checked.
 - Click OK
2. Add counter structure(s) to the DB:
 - In the new global DB, add a new static tag using one of the counter data types. Be sure to consider the Type you want to use for your Preset and Count values.
 - In the "Retain" column, check the box so that this structure will be retentive.
 - Repeat this process to create structures for all the counters that you want to store in this DB. You can either place each counter structure in a unique global DB, or you can place multiple counter structures into the same global DB. You can also place other static tags besides counters in this global DB. Placing multiple counter structures into the same global DB allows you to reduce your overall number of blocks.
 - Rename the counter structures if desired.
3. Open the program block for editing where you want to place a retentive counter (OB, FC, or FB).
4. Place the counter instruction at the desired location.
5. When the call options dialog appears, click the cancel button. You should now see a new counter instruction which has "???" both just above and just below the instruction name.
6. On the top of the new counter instruction, type the name (do not use the helper to browse) of the global DB and counter structure that you created above (example: "Data_block_3.Static_1"). This causes the corresponding preset and count value type to be filled in (example: UInt for an IEC_UCounter structure).

| Counter Data Type | Corresponding Type for the Preset and Count Values |
|-------------------|--|
| IEC_Counter | INT |
| IEC_SCounter | SINT |
| IEC_DCounter | DINT |
| IEC_UCounter | UINT |
| IEC_USCounter | USINT |
| IEC_UDCounter | UDINT |

Assign a multi-instance DB to store counter data as retentive data

This option only works if you place the counter in an FB.

This option depends upon whether the FB properties specify "Optimized block access" (allows symbolic access only). To verify how the access attribute is configured for an existing FB, right-click on the FB in the Project tree, choose properties, and then choose Attributes.

If the FB specifies "Optimized block access" (allows symbolic access only):

1. Open the FB for edit.
2. Place the counter instruction at the desired location in the FB.
3. When the Call options dialog appears, click on the Multi instance icon. The Multi Instance option is only available if the instruction is being placed into an FB.
4. In the Call options dialog, rename the counter if desired.
5. Click OK. The counter instruction appears in the editor with type INT for the preset and count values, and the IEC_COUNTER structure appears in the FB Interface under Static.
6. If desired, change the type in the counter instruction from INT to one of the other types. The counter structure will change correspondingly.
7. If necessary, open the FB interface editor (may have to click on the small arrow to expand the view).
8. Under Static, locate the counter structure that was just created for you.
9. In the Retain column for this counter structure, change the selection to "Retain". Whenever this FB is called later from another program block, an instance DB will be created with this interface definition which contains the counter structure marked as retentive.

If the FB does not specify "Optimized block access", then the block access type is standard, which is compatible with S7-300/400 classic configurations and allows symbolic and direct access. To assign a multi-instance to a standard block access FB, follow these steps:

1. Open the FB for edit.
2. Place the counter instruction at the desired location in the FB.
3. When the Call options dialog appears, click on the multi instance icon. The multi instance option is only available if the instruction is being placed into an FB.
4. In the Call options dialog, rename the counter if desired.

5. Click OK. The counter instruction appears in the editor with type INT for the preset and count value, and the IEC_COUNTER structure appears in the FB Interface under Static.
6. If desired, change the type in the counter instruction from INT to one of the other types. The counter structure will change correspondingly.
7. Open the block that will use this FB.
8. Place this FB at the desired location. Doing so results in the creation of an instance data block for this FB.
9. Open the instance data block created when you placed the FB in the editor.
10. Under Static, locate the counter structure of interest. In the Retain column for this counter structure, check the box to make this structure retentive.

| Type shown in counter instruction (for preset and count values) | Corresponding structure | Type shown in FB interface |
|---|-------------------------|----------------------------|
| INT | IEC_Counter | |
| SINT | IEC_SCounter | |
| DINT | IEC_DCounter | |
| UINT | IEC_UCounter | |
| USINT | IEC_USCounter | |
| UDINT | IEC_UDCounter | |

7.4 Comparator operations

7.4.1 Compare values instructions

Table 7- 28 Compare instructions

| LAD | FBD | SCL | Description |
|--|-----|--|---|
| <pre> "IN1" == Byte "IN2" </pre> | | <pre> out := in1 = in2; or IF in1 = in2 THEN out := 1; ELSE out := 0; END IF; </pre> | <p>Compares two values of the same data type. When the LAD contact comparison is TRUE, then the contact is activated. When the FBD box comparison is TRUE, then the box output is TRUE.</p> |

- For LAD and FBD: Click the instruction name (such as "==") to change the comparison type from the drop-down list. Click the "???" and select data type from the drop-down list.

Table 7- 29 Data types for the parameters

| Parameter | Data type | Description |
|-----------|---|-------------------|
| IN1, IN2 | SInt, Int, DInt, USInt, UInt, UDInt, Real, LReal, String, Char, Time, DTL, Constant | Values to compare |

Table 7- 30 Comparison descriptions

| Relation type | The comparison is true if ... |
|---------------|-------------------------------------|
| = | IN1 is equal to IN2 |
| <> | IN1 is not equal to IN2 |
| >= | IN1 is greater than or equal to IN2 |
| <= | IN1 is less than or equal to IN2 |
| > | IN1 is greater than IN2 |
| < | IN1 is less than IN2 |

7.4.2 IN_Range (Value within range) and OUT_Range (Value outside range) instructions

Table 7- 31 Value within Range and value outside range instructions

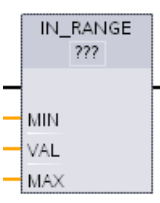
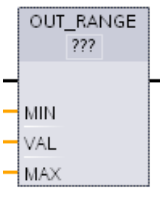
| LAD / FBD | SCL | Description |
|---|---|--|
|  | <pre>out := IN_RANGE(min, val, max);</pre> | Tests whether an input value is in or out of a specified value range. If the comparison is TRUE, then the box output is TRUE. |
|  | <pre>out := OUT_RANGE(min, val, max);</pre> | |

¹ For LAD and FBD: Click the "???" and select the data type from the drop-down list.

Table 7- 32 Data types for the parameters

| Parameter | Data type ¹ | Description |
|---------------|--|-------------------|
| MIN, VAL, MAX | SInt, Int, DInt, USInt, UInt, UDInt, Real, LReal, Constant | Comparator inputs |

- ¹ The input parameters MIN, VAL, and MAX must be the same data type.
- The IN_RANGE comparison is true if: MIN <= VAL <= MAX
 - The OUT_RANGE comparison is true if: VAL < MIN or VAL > MAX

7.4.3 OK (Check validity) and NOT_OK (Check invalidity) instructions

Table 7- 33 OK (check validity) and Not OK (check invalidity) instructions

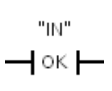
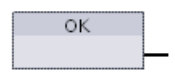
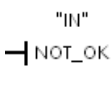
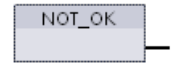
| LAD | FBD | SCL | Description |
|---|---|---------------|---|
|  |  | Not available | Tests whether an input data reference is a valid real number according to IEEE specification 754. |
|  |  | Not available | |

¹ For LAD and FBD: When the LAD contact is TRUE, the contact is activated and passes power flow. When the FBD box is TRUE, then the box output is TRUE.

Table 7- 34 Data types for the parameter

| Parameter | Data type | Description |
|-----------|-------------|-------------|
| IN | Real, LReal | Input data |

Table 7- 35 Operation

| Instruction | The Real number test is TRUE if: |
|-------------|---|
| OK | The input value is a valid real number ¹ |
| NOT_OK | The input value is not a valid real number ¹ |

¹ A Real or LReal value is invalid if it is +/- INF (infinity), NaN (Not a Number), or if it is a denormalized value. A denormalized value is a number very close to zero. The CPU substitutes a zero for a denormalized value in calculations.

7.5 Math functions

7.5.1 CALCULATE (Calculate) instruction

Table 7- 36 CALCULATE instruction

| LAD / FBD | SCL | Description |
|---|--|---|
|  | <p>Use the standard SCL math expressions to create the equation.</p> | <p>The CALCULATE instruction lets you create a math function that operates on inputs (IN1, IN2, .. INn) and produces the result at OUT, according to the equation that you define.</p> <ul style="list-style-type: none"> • Select a data type first. All inputs and the output must be the same data type. • To add another input, click the icon at the last input. |

Table 7- 37 Data types for the parameters

| Parameter | Data type ¹ |
|-----------------|---|
| IN1, IN2, ..INn | SInt, Int, DInt, USInt, UInt, UDInt, Real, LReal, Byte, Word, DWord |
| OUT | SInt, Int, DInt, USInt, UInt, UDInt, Real, LReal, Byte, Word, DWord |

¹ The IN and OUT parameters must be the same data type (with implicit conversions of the input parameters). For example: A SINT value for an input would be converted to an INT or a REAL value if OUT is an INT or REAL

Click the calculator icon to open the dialog and define your math function. You enter your equation as inputs (such as IN1 and IN2) and operations. When you click "OK" to save the function, the dialog automatically creates the inputs for the CALCULATE instruction.

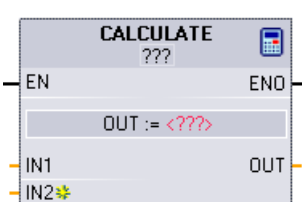
An example and a list of possible math operations you can include is shown at the bottom of the editor.

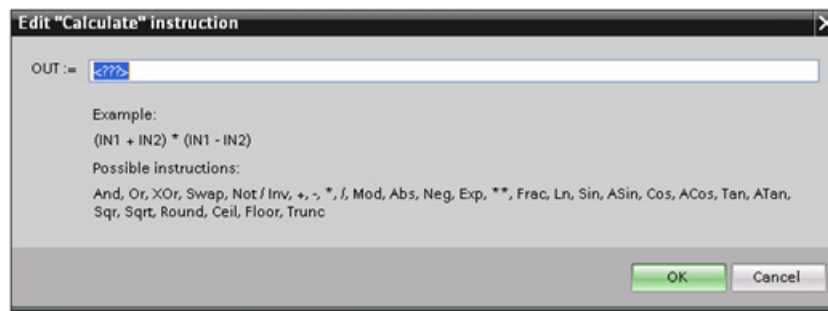

Note

You also must create an input for any constants in your function. The constant value would then be entered in the associated input for the CALCULATE instruction.

By entering constants as inputs, you can copy the CALCULATE instruction to other locations in your user program without having to change the function. You then can change the values or tags of the inputs for the instruction without modifying the function.

When CALCULATE is executed and all the individual operations in the calculation complete successfully, then the ENO = 1. Otherwise, ENO = 0.

7.5.2 Add, subtract, multiply and divide instructions

Table 7- 38 Add, subtract, multiply and divide instructions

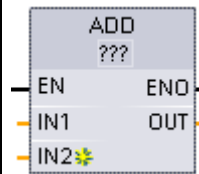
| LAD / FBD | SCL | Description |
|--|--|--|
|  | <pre> out := in1 + in2; out := in1 - in2; out := in1 * in2; out := in1 / in2; </pre> | <ul style="list-style-type: none"> • ADD: Addition (IN1 + IN2 = OUT) • SUB: Subtraction (IN1 - IN2 = OUT) • MUL: Multiplication (IN1 * IN2 = OUT) • DIV: Division (IN1 / IN2 = OUT) <p>An Integer division operation truncates the fractional part of the quotient to produce an integer output.</p> |

¹ For LAD and FBD: Click the "???" and select a data type from the drop-down menu.

Table 7- 39 Data types for the parameters (LAD and FBD)

| Parameter | Data type ¹ | Description |
|-----------|---|-----------------------|
| IN1, IN2 | SInt, Int, DInt, USInt, UInt, UDIInt, Real, LReal, Constant | Math operation inputs |
| OUT | SInt, Int, DInt, USInt, UInt, UDIInt, Real, LReal | Math operation output |

¹ Parameters IN1, IN2, and OUT must be the same data type.



To add an ADD or MUL input, click the "Create" icon or right-click on an input stub for one of the existing IN parameters and select the "Insert input" command.

To remove an input, right-click on an input stub for one of the existing IN parameters (when there are more than the original two inputs) and select the "Delete" command.

When enabled (EN = 1), the math instruction performs the specified operation on the input values (IN1 and IN2) and stores the result in the memory address specified by the output parameter (OUT). After the successful completion of the operation, the instruction sets ENO = 1.

Table 7- 40 ENO status

| ENO | Description |
|-----|--|
| 1 | No error |
| 0 | The Math operation result value would be outside the valid number range of the data type selected. The least significant part of the result that fits in the destination size is returned. |
| 0 | Division by 0 (IN2 = 0): The result is undefined and zero is returned. |
| 0 | Real/LReal: If one of the input values is NaN (not a number) then NaN is returned. |
| 0 | ADD Real/LReal: If both IN values are INF with different signs, this is an illegal operation and NaN is returned. |
| 0 | SUB Real/LReal: If both IN values are INF with the same sign, this is an illegal operation and NaN is returned. |
| 0 | MUL Real/LReal: If one IN value is zero and the other is INF, this is an illegal operation and NaN is returned. |
| 0 | DIV Real/LReal: If both IN values are zero or INF, this is an illegal operation and NaN is returned. |

7.5.3 MOD (return remainder of division) instruction

Table 7- 41 Modulo (return remainder of division) instruction

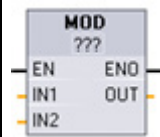
| LAD / FBD | SCL | Description |
|---|--------------------------------|---|
|  | <pre>out := in1 MOD in2;</pre> | <p>You can use the MOD instruction to return the remainder of an integer division operation. The value at the IN1 input is divided by the value at the IN2 input and the remainder is returned at the OUT output.</p> |

¹ For LAD and FBD: Click the "???" and select a data type from the drop-down menu.

Table 7- 42 Data types for parameters

| Parameter | Data type ¹ | Description |
|-------------|--|---------------|
| IN1 and IN2 | SInt, Int, DInt, USInt, UInt, UDIInt, Constant | Modulo inputs |
| OUT | SInt, Int, DInt, USInt, UInt, UDIInt | Modulo output |

¹ The IN1, IN2, and OUT parameters must be the same data type.

Table 7- 43 ENO values

| ENO | Description |
|-----|---|
| 1 | No error |
| 0 | Value IN2 = 0, OUT is assigned the value zero |

7.5.4 NEG (Create twos complement) instruction

Table 7- 44 NEG (create twos complement) instruction

| LAD / FBD | SCL | Description |
|-----------|-----------------------|--|
| | <code>- (in) ;</code> | The NEG instruction inverts the arithmetic sign of the value at parameter IN and stores the result in parameter OUT. |

¹ For LAD and FBD: Click the "???" and select a data type from the drop-down menu.

Table 7- 45 Data types for parameters

| Parameter | Data type ¹ | Description |
|-----------|--|-----------------------|
| IN | SInt, Int, DInt, Real, LReal, Constant | Math operation input |
| OUT | SInt, Int, DInt, Real, LReal | Math operation output |

¹ The IN and OUT parameters must be the same data type.

Table 7- 46 ENO status

| ENO | Description |
|-----|---|
| 1 | No error |
| 0 | The resulting value is outside the valid number range of the selected data type. Example for SInt: NEG (-128) results in +128 which exceeds the data type maximum. |

7.5.5 INC (Increment) and DEC (Decrement) instructions

Table 7- 47 INC and DEC instructions

| LAD / FBD | SCL | Description |
|-----------|------------------------------------|--|
| | <code>in_out := in_out + 1;</code> | Increments a signed or unsigned integer number value: IN_OUT value +1 = IN_OUT value |
| | <code>in_out := in_out - 1;</code> | Decrements a signed or unsigned integer number value: IN_OUT value - 1 = IN_OUT value |

¹ For LAD and FBD: Click the "???" and select a data type from the drop-down menu.

Table 7- 48 Data types for parameters

| Parameter | Data type | Description |
|-----------|-------------------------------------|---------------------------------|
| IN/OUT | SInt, Int, DInt, USInt, UInt, UDInt | Math operation input and output |

Table 7- 49 ENO status

| ENO | Description |
|-----|--|
| 1 | No error |
| 0 | The resulting value is outside the valid number range of the selected data type. Example for SInt: INC (+127) results in +128, which exceeds the data type maximum. |

7.5.6 ABS (Form absolute value) instruction

Table 7- 50 ABS (absolute value) instruction

| LAD / FBD | SCL | Description |
|-----------|----------------------------|--|
| | <pre>out := ABS(in);</pre> | Calculates the absolute value of a signed integer or real number at parameter IN and stores the result in parameter OUT. |

¹ For LAD and FBD: Click the "???" and select a data type from the drop-down menu.

Table 7- 51 Data types for parameters

| Parameter | Data type ¹ | Description |
|-----------|------------------------------|-----------------------|
| IN | SInt, Int, DInt, Real, LReal | Math operation input |
| OUT | SInt, Int, DInt, Real, LReal | Math operation output |

¹ The IN and OUT parameters must be the same data type.

Table 7- 52 ENO status

| ENO | Description |
|-----|---|
| 1 | No error |
| 0 | The math operation result value is outside the valid number range of the selected data type. Example for SInt: ABS (-128) results in +128 which exceeds the data type maximum. |

7.5.7 MIN (Get minimum) and MAX (Get maximum) instructions

Table 7- 53 MIN (get minimum) and MAX (get maximum) instructions

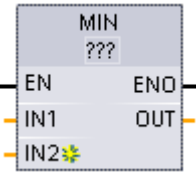
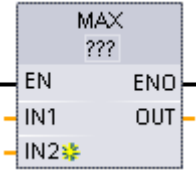
| LAD / FBD | SCL | Description |
|---|---|---|
|  | <pre>out := MIN(in1 := _variant_in_, in2 := _variant_in_ [, ...in32]);</pre> | <p>The MIN instruction compares the value of two parameters IN1 and IN2 and assigns the minimum (lesser) value to parameter OUT.</p> |
|  | <pre>out := MAX(in1 := _variant_in_, in2 := _variant_in_ [, ...in32]);</pre> | <p>The MAX instruction compares the value of two parameters IN1 and IN2 and assigns the maximum (greater) value to parameter OUT.</p> |

¹ For LAD and FBD: Click the "???" and select a data type from the drop-down menu.

Table 7- 54 Data types for the parameters

| Parameter | Data type ¹ | Description |
|-----------------------|--|---|
| IN1, IN2 [...IN32] | SInt, Int, DInt, USInt, UInt, UDInt, Real, LReal, Constant | Math operation inputs (up to 32 inputs) |
| OUT | SInt, Int, DInt, USInt, UInt, UDInt, Real, LReal | Math operation output |

¹ The IN1, IN2, and OUT parameters must be the same data type.



To add an input, click the "Create" icon or right-click on an input stub for one of the existing IN parameters and select the "Insert input" command.

To remove an input, right-click on an input stub for one of the existing IN parameters (when there are more than the original two inputs) and select the "Delete" command.

Table 7- 55 ENO status

| ENO | Description |
|-----|---|
| 1 | No error |
| 0 | For Real data type only: <ul style="list-style-type: none"> At least one input is not a real number (NaN). The resulting OUT is +/- INF (infinity). |

7.5.8 LIMIT (Set limit value) instruction

Table 7- 56 LIMIT (set limit value) instruction

| LAD / FBD | SCL | Description |
|---|---|---|
|  | <pre>LIMIT(MN:=_variant_in_, IN:=_variant_in_, MX:=_variant_in_, OUT:=_variant_out_);</pre> | <p>The Limit instruction tests if the value of parameter IN is inside the value range specified by parameters MIN and MAX and if not, clamps the value at MIN or MAX.</p> |

¹ For LAD and FBD: Click the "???" and select a data type from the drop-down menu.

Table 7- 57 Data types for the parameters

| Parameter | Data type ¹ | Description |
|----------------|--|-----------------------|
| MN, IN, and MX | SInt, Int, DInt, USInt, UInt, UDInt, Real, LReal, Constant | Math operation inputs |
| OUT | SInt, Int, DInt, USInt, UInt, UDInt, Real, LReal | Math operation output |

¹ The MN, IN, MX, and OUT parameters must be the same data type.

If the value of parameter IN is within the specified range, then the value of IN is stored in parameter OUT. If the value of parameter IN is outside of the specified range, then the OUT value is the value of parameter MIN (if the IN value is less than the MIN value) or the value of parameter MAX (if the IN value is greater than the MAX value).

Table 7- 58 ENO status

| ENO | Description |
|-----|---|
| 1 | No error |
| 0 | Real: If one or more of the values for MIN, IN and MAX is NaN (Not a Number), then NaN is returned. |
| 0 | If MIN is greater than MAX, the value IN is assigned to OUT. |

SCL examples:

- MyVal := LIMIT(MN:=10,IN:=53, MX:=40); //Result: MyVal = 40
- MyVal := LIMIT(MN:=10,IN:=37, MX:=40); //Result: MyVal = 37
- MyVal := LIMIT(MN:=10,IN:=8, MX:=40); //Result: MyVal = 10

7.5.9 Exponent, logarithm, and trigonometry instructions



You use the floating point instructions to program mathematical operations using a Real or LReal data type:

- SQR: Form square ($IN^2 = OUT$)
- SQRT: Form square root ($\sqrt{IN} = OUT$)
- LN: Form natural logarithm ($LN(IN) = OUT$)
- EXP: Form exponential value ($e^{IN} = OUT$), where base $e = 2.71828182845904523536$
- EXPT: exponentiate ($IN1^{IN2} = OUT$)

EXPT parameters IN1 and OUT are always the same data type, for which you must select Real or LReal. You can select the data type for the exponent parameter IN2 from among many data types.

- FRAC: Return fraction (fractional part of floating point number $IN = OUT$)
- SIN: Form sine value ($\sin(IN \text{ radians}) = OUT$)
- ASIN: Form arcsine value ($\arcsin(IN) = OUT \text{ radians}$), where the $\sin(OUT \text{ radians}) = IN$
- COS: Form cosine ($\cos(IN \text{ radians}) = OUT$)
- ACOS: Form arccosine value ($\arccos(IN) = OUT \text{ radians}$), where the $\cos(OUT \text{ radians}) = IN$
- TAN: Form tangent value ($\tan(IN \text{ radians}) = OUT$)
- ATAN: Form arctangent value ($\arctan(IN) = OUT \text{ radians}$), where the $\tan(OUT \text{ radians}) = IN$

Table 7- 59 Examples of floating-point math instructions

| LAD / FBD | SCL | Description |
|---|---|---|
|  | <pre>out := SQR(in);</pre> <p>or</p> <pre>out := in * in;</pre> | <p>Square: $IN^2 = OUT$ For example: If $IN = 9$, then $OUT = 81$.</p> |
|  | <pre>out := in1 ** in2;</pre> | <p>General exponential: $IN1^{IN2} = OUT$ For example: If $IN1 = 3$ and $IN2 = 2$, then $OUT = 9$.</p> |

1 For LAD and FBD: Click the "???" (by the instruction name) and select a data type from the drop-down menu.
 2 For SCL: You can also use the basic SCL math operators to create the mathematical expressions.

Table 7- 60 Data types for parameters

| Parameter | Data type | Description |
|-----------|---|---------------------|
| IN, IN1 | Real, LReal, Constant | Inputs |
| IN2 | SInt, Int, DInt, USInt, UInt,UDInt, Real, LReal, Constant | EXPT exponent input |
| OUT | Real, LReal | Outputs |

Table 7- 61 ENO status

| ENO | Instruction | Condition | Result (OUT) |
|---|---------------|--|--------------------|
| 1 | All | No error | Valid result |
| 0 | SQR | Result exceeds valid Real/LReal range | +INF |
| | | IN is +/- NaN (not a number) | +NaN |
| | SQRT | IN is negative | -NaN |
| | | IN is +/- INF (infinity) or +/- NaN | +/- INF or +/- NaN |
| | LN | IN is 0.0, negative, -INF, or -NaN | -NaN |
| | | IN is +INF or +NaN | +INF or +NaN |
| | EXP | Result exceeds valid Real/LReal range | +INF |
| | | IN is +/- NaN | +/- NaN |
| | SIN, COS, TAN | IN is +/- INF or +/- NaN | +/- INF or +/- NaN |
| | ASIN, ACOS | IN is outside valid range of -1.0 to +1.0 | +NaN |
| | | IN is +/- NaN | +/- NaN |
| | ATAN | IN is +/- NaN | +/- NaN |
| | FRAC | IN is +/- INF or +/- NaN | +NaN |
| | EXPT | IN1 is +INF and IN2 is not -INF | +INF |
| IN1 is negative or -INF | | +NaN if IN2 is Real/LReal, -INF otherwise | |
| IN1 or IN2 is +/- NaN | | +NaN | |
| IN1 is 0.0 and IN2 is Real/LReal (only) | | +NaN | |

7.6 Move operations

7.6.1 MOVE (Move value), MOVE_BLK (Move block), and UMOVE_BLK (Move block uninterruptible) instructions

Use the Move instructions to copy data elements to a new memory address and convert from one data type to another. The source data is not changed by the move process.

- The MOVE instruction copies a single data element from the source address specified by the IN parameter to the destination addresses specified by the OUT parameter.
- The MOVE_BLK and UMOVE_BLK instructions have an additional COUNT parameter. The COUNT specifies how many data elements are copied. The number of bytes per element copied depends on the data type assigned to the IN and OUT parameter tag names in the PLC tag table.

Table 7- 62 MOVE, MOVE_BLK and UMOVE_BLK instructions

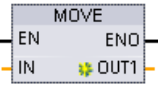
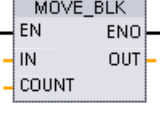
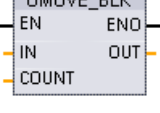
| LAD / FBD | SCL | Description |
|---|--|--|
|  | <pre>out1 := in;</pre> | Copies a data element stored at a specified address to a new address or multiple addresses. ¹ |
|  | <pre>MOVE_BLK(in:=_variant_in, count:=_uint_in, out=>_variant_out);</pre> | Interruptible move that copies a block of data elements to a new address. |
|  | <pre>UMOVE_BLK(in:=_variant_in, count:=_uint_in, out=>_variant_out);</pre> | Uninterruptible move that copies a block of data elements to a new address. |

¹ MOVE instruction: To add another output in LAD or FBD, click the "Create" icon by the output parameter. For SCL, use multiple assignment statements. You might also use one of the loop constructions.

Table 7- 63 Data types for the MOVE instruction

| Parameter | Data type | Description |
|-----------|---|---------------------|
| IN | SInt, Int, DInt, USInt, UInt, UDInt, Real, LReal, Byte, Word, DWord, Char, Array, Struct, DTL, Time | Source address |
| OUT | SInt, Int, DInt, USInt, UInt, UDInt, Real, LReal, Byte, Word, DWord, Char, Array, Struct, DTL, Time | Destination address |



To add MOVE outputs, click the "Create" icon or right-click on an output stub for one of the existing OUT parameters and select the "Insert output" command.

To remove an output, right-click on an output stub for one of the existing OUT parameters (when there are more than the original two outputs) and select the "Delete" command.

Table 7- 64 Data types for the MOVE_BLK and UMOVE_BLK instructions

| Parameter | Data type | Description |
|-----------|--|---------------------------------|
| IN | SInt, Int, DInt, USInt, UInt, UDIInt, Real, LReal, Byte, Word, DWord | Source start address |
| COUNT | UInt | Number of data elements to copy |
| OUT | SInt, Int, DInt, USInt, UInt, UDIInt, Real, LReal, Byte, Word, DWord | Destination start address |

Note

Rules for data copy operations

- To copy the Bool data type, use SET_BF, RESET_BF, R, S, or output coil (LAD) (Page 206)
- To copy a single elementary data type, use MOVE
- To copy an array of an elementary data type, use MOVE_BLK or UMOVE_BLK
- To copy a structure, use MOVE
- To copy a string, use S_MOVE (Page 293)
- To copy a single character in a string, use MOVE
- The MOVE_BLK and UMOVE_BLK instructions cannot be used to copy arrays or structures to the I, Q, or M memory areas.

MOVE_BLK and UMOVE_BLK instructions differ in how interrupts are handled:

- Interrupt events are **queued and processed** during MOVE_BLK execution. Use the MOVE_BLK instruction when the data at the move destination address is not used within an interrupt OB subprogram or, if used, the destination data does not have to be consistent. If a MOVE_BLK operation is interrupted, then the last data element moved is complete and consistent at the destination address. The MOVE_BLK operation is resumed after the interrupt OB execution is complete.
- Interrupt events are **queued but not processed** until UMOVE_BLK execution is complete. Use the UMOVE_BLK instruction when the move operation must be completed and the destination data consistent, before the execution of an interrupt OB subprogram. For more information, see the section on data consistency (Page 178).

ENO is always true following execution of the MOVE instruction.

Table 7- 65 ENO status



| ENO | Condition | Result |
|-----|--|---|
| 1 | No error | All COUNT elements were successfully copied. |
| 0 | Either the source (IN) range or the destination (OUT) range exceeds the available memory area. | Elements that fit are copied. No partial elements are copied. |

7.6.2 FieldRead (Read field) and FieldWrite (Write field) instructions

Note

STEP 7 V10.5 **did not support** a variable reference as an array index or multi-dimensional arrays. The FieldRead and FieldWrite instructions were used to provide variable array index operations for a one-dimensional array. STEP 7 V11 and greater **do support** a variable as an array index and multi-dimensional arrays. FieldRead and FieldWrite are included in STEP 7 V11 and greater for backward compatibility with programs that have used these instructions.

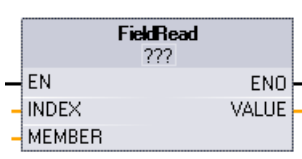
Table 7- 66 FieldRead and FieldWrite instructions

| LAD / FBD | SCL | Description |
|---|------------------------------------|---|
|  | <pre>value := member[index];</pre> | FieldRead reads the array element with the index value INDEX from the array whose first element is specified by the MEMBER parameter. The value of the array element is transferred to the location specified at the VALUE parameter. |
|  | <pre>member[index] := value;</pre> | WriteField transfers the value at the location specified by the VALUE parameter to the array whose first element is specified by the MEMBER parameter. The value is transferred to the array element whose array index is specified by the INDEX parameter. |

¹ For LAD and FBD: Click the "???" and select a data type from the drop-down menu.

Table 7- 67 Data types for parameters

| Parameter and type | | Data type | Description |
|---------------------|-------|---|---|
| Index | Input | DInt | The index number of the array element to be read or written to |
| Member ¹ | Input | Array element types: Bool, Byte, Word, DWord, Char, SInt, Int, DInt, USInt, UInt, UDInt, Real, LReal | Location of the first element in a one- dimension array defined in a global data block or block interface. For example: If the array index is specified as [-2..4], then the index of the first element is -2 and not 0. |
| Value ¹ | Out | Bool, Byte, Word, DWord, Char, SInt, Int, DInt, USInt, UInt, UDInt, Real, LReal | Location to which the specified array element is copied (FieldRead) Location of the value that is copied to the specified array element (FieldWrite) |

¹ The data type of the array element specified by the MEMBER parameter and the VALUE parameter must have the same data type.

The enable output ENO = 0, if one of the following conditions applies:

- The EN input has signal state "0"
- The array element specified at the INDEX parameter is not defined in the array referenced at MEMBER parameter
- Errors such as an overflow occur during processing

Accessing data by array indexing

To access elements of an array with a variable, simply use the variable as an array index in your program logic. For example, the network below sets an output based on the Boolean value of an array of Booleans in "Data_block_1" referenced by the PLC tag "Index".

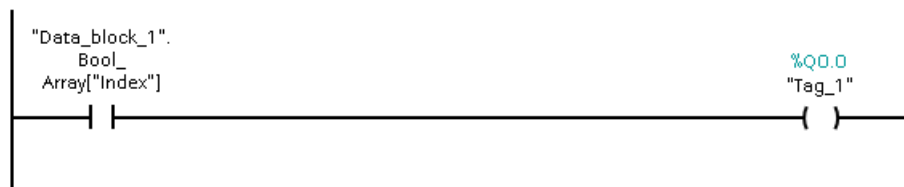

The logic with the variable array index is equivalent to the former method using the FieldRead instruction:

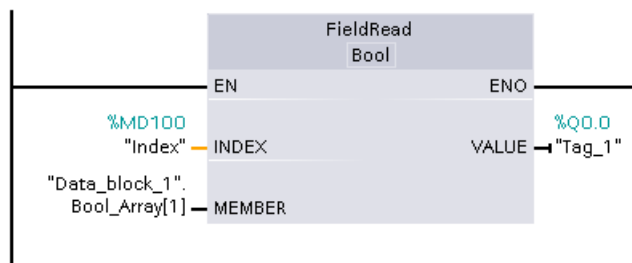

FieldWrite and FieldRead instructions can be replaced with variable array indexing logic.

SCL has no FieldRead or FieldWrite instructions, but supports indirect addressing of an array with a variable:

```
#Tag_1 := "Data_block_1".Bool_Array[#Index];
```

7.6.3 FILL_BLK (Fill block) and UFILL_BLK (Fill block uninterruptible) instructions

Table 7- 68 FILL_BLK and UFILL_BLK instructions



| LAD / FBD | SCL | Description |
|---|--|--|
|  | <pre>FILL_BLK(in:=_variant_in, count:=int, out=>_variant_out);</pre> | Interruptible fill instruction: Fills an address range with copies of a specified data element |
|  | <pre>UFILL_BLK(in:=_variant_in, count:=int out=>_variant_out);</pre> | Uninterruptible fill instruction: Fills an address range with copies of a specified data element |

Table 7- 69 Data types for parameters

| Parameter | Data type | Description |
|-----------|--|---------------------------------|
| IN | SInt, Int, DInt, USInt, UInt, UDIInt, Real, LReal, Byte, Word, DWord | Data source address |
| COUNT | USInt, UInt | Number of data elements to copy |
| OUT | SInt, Int, DInt, USInt, UInt, UDIInt, Real, LReal, Byte, Word, DWord | Data destination address |

Note

Rules for data fill operations

- To fill with the BOOL data type, use SET_BF, RESET_BF, R, S, or output coil (LAD)
- To fill with a single elementary data type, use MOVE
- To fill an array with an elementary data type, use FILL_BLK or UFILL_BLK
- To fill a single character in a string, use MOVE
- The FILL_BLK and UFILL_BLK instructions cannot be used to fill arrays in the I, Q, or M memory areas.

The FILL_BLK and UFILL_BLK instructions copy the source data element IN to the destination where the initial address is specified by the parameter OUT. The copy process repeats and a block of adjacent addresses is filled until the number of copies is equal to the COUNT parameter.

FILL_BLK and UFILL_BLK instructions differ in how interrupts are handled:

- Interrupt events are **queued and processed** during FILL_BLK execution. Use the FILL_BLK instruction when the data at the move destination address is not used within an interrupt OB subprogram or, if used, the destination data does not have to be consistent.
- Interrupt events are **queued but not processed** until UFILL_BLK execution is complete. Use the UFILL_BLK instruction when the move operation must be completed and the destination data consistent, before the execution of an interrupt OB subprogram.

Table 7- 70 ENO status

| ENO | Condition | Result |
|-----|---|---|
| 1 | No error | The IN element was successfully copied to all COUNT destinations. |
| 0 | The destination (OUT) range exceeds the available memory area | Elements that fit are copied. No partial elements are copied. |

7.6.4 SWAP (Swap bytes) instruction

Table 7- 71 SWAP instruction

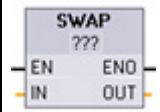
| LAD / FBD | SCL | Description |
|---|-----------------------------|--|
|  | <pre>out := SWAP(in);</pre> | Reverses the byte order for two-byte and four-byte data elements. No change is made to the bit order within each byte. ENO is always TRUE following execution of the SWAP instruction. |

¹ For LAD and FBD: Click the "???" and select a data type from the drop-down menu.

Table 7- 74 Data types for the parameters

| Parameter | Data type | Description |
|-----------|--|--|
| IN | Bit string ¹ , SInt, USInt, Int, UInt, DInt, UDInt, Real, LReal, BCD16, BCD32 | Input value |
| OUT | Bit string ¹ , SInt, USInt, Int, UInt, DInt, UDInt, Real, LReal, BCD16, BCD32 | Input value converted to a new data type |

¹ The instruction does not allow you to select Bit strings (Byte, Word, DWord). To enter an operand of data type Byte, Word, or DWord for a parameter of the instruction, select an unsigned integer with the same bit length. For example, select USInt for a Byte, UInt for a Word, or UDInt for a DWord.

After you select the (convert from) data type, a list of possible conversions is shown in the (convert to) dropdown list. Conversions from and to BCD16 are restricted to the Int data type. Conversions from and to BCD32 are restricted to the DInt data type.

Table 7- 75 ENO status

| ENO | Description | Result OUT |
|-----|--|----------------------------|
| 1 | No error | Valid result |
| 0 | IN is +/- INF or +/- NaN | +/- INF or +/- NaN |
| 0 | Result exceeds valid range for OUT data type | OUT is set to the IN value |

7.7.2 Conversion instructions for SCL

Conversion instructions for SCL

Table 7- 76 Conversion from a Bool, Byte, Word, or DWord

| Data type | Instruction | Result |
|-----------|--|---|
| Bool | BOOL_TO_BYTE, BOOL_TO_WORD, BOOL_TO_DWORD, BOOL_TO_INT, BOOL_TO_DINT | The value is transferred to the least significant bit of the target data type. |
| Byte | BYTE_TO_BOOL | The least significant bit is transferred into the destination data type. |
| | BYTE_TO_WORD, BYTE_TO_DWORD | The value is transferred to the least significant byte of the target data type. |
| | BYTE_TO_SINT, BYTE_TO_USINT | The value is transferred to the target data type. |
| | BYTE_TO_INT, BYTE_TO_UINT, BYTE_TO_DINT, BYTE_TO_UDINT | The value is transferred to the least significant byte of the target data type. |
| Word | WORD_TO_BOOL | The least significant bit is transferred into the destination data type. |
| | WORD_TO_BYTE | The least significant byte of the source value is transferred to the target data type |
| | WORD_TO_DWORD | The value is transferred to the least significant word of the target data type. |

7.7 Conversion operations

| Data type | Instruction | Result |
|-----------|--|--|
| | WORD_TO_SINT, WORD_TO_USINT | The least significant byte of the source value is transferred to the target data type. |
| | WORD_TO_INT, WORD_TO_UINT | The value is transferred to the target data type. |
| | WORD_TO_DINT, WORD_TO_UDINT | The value is transferred to the least significant word of the target data type. |
| DWord | DWORD_TO_BOOL | The least significant bit is transferred into the destination data type. |
| | DWORD_TO_BYTE, DWORD_TO_WORD, DWORD_TO_SINT | The least significant byte of the source value is transferred to the target data type. |
| | DWORD_TO_USINT, DWORD_TO_INT, DWORD_TO_UINT | The least significant word of the source value is transferred to the target data type. |
| | DWORD_TO_DINT, DWORD_TO_UDINT, DWORD_TO_REAL | The value is transferred to the target data type. |

Table 7- 77 Conversion from a short integer (SInt or USInt)

| Data type | Instruction | Result |
|-----------|--|---|
| SInt | SINT_TO_BOOL | The least significant bit is transferred into the destination data type. |
| | SINT_TO_BYTE | The value is transferred to the target data type |
| | SINT_TO_WORD, SINT_TO_DWORD | The value is transferred to the least significant byte of the target data type. |
| | SINT_TO_INT, SINT_TO_DINT, SINT_TO_USINT, SINT_TO_UINT, SINT_TO_UDINT, SINT_TO_REAL, SINT_TO_LREAL, SINT_TO_CHAR, SINT_TO_STRING | The value is converted. |
| USInt | USINT_TO_BOOL | The least significant bit is transferred into the destination data type. |
| | USINT_TO_BYTE | The value is transferred to the target data type |
| | USINT_TO_WORD, USINT_TO_DWORD, USINT_TO_INT, USINT_TO_UINT, USINT_TO_DINT, USINT_TO_UDINT | The value is transferred to the least significant byte of the target data type. |
| | USINT_TO_SINT, USINT_TO_REAL, USINT_TO_LREAL, USINT_TO_CHAR, USINT_TO_STRING | The value is converted. |

Table 7- 78 Conversion from an integer (Int or UInt)

| Data type | instruction | Result |
|-----------|--|---|
| Int | INT_TO_BOOL | The least significant bit is transferred into the destination data type. |
| | INT_TO_BYTE, INT_TO_DWORD, INT_TO_SINT, INT_TO_USINT, INT_TO_UINT, INT_TO_UDINT, INT_TO_REAL, INT_TO_LREAL, INT_TO_CHAR, INT_TO_STRING | The value is converted. |
| | INT_TO_WORD | The value is transferred to the target data type. |
| | INT_TO_DINT | The value is transferred to the least significant byte of the target data type. |
| UInt | UINT_TO_BOOL | The least significant bit is transferred into the destination data type. |
| | UINT_TO_BYTE, UINT_TO_SINT, UINT_TO_USINT, UINT_TO_INT, UINT_TO_REAL, UINT_TO_LREAL, UINT_TO_CHAR, UINT_TO_STRING | The value is converted. |
| | UINT_TO_WORD, UINT_TO_DATE | The value is transferred to the target data type. |
| | UINT_TO_DWORD, UINT_TO_DINT, UINT_TO_UDINT | The value is transferred to the least significant byte of the target data type. |

Table 7- 79 Conversion from a double integer (Dint or UDInt)

| Data type | Instruction | Result |
|-----------|---|--|
| DInt | DINT_TO_BOOL | The least significant bit is transferred into the destination data type. |
| | DINT_TO_BYTE, DINT_TO_WORD, DINT_TO_SINT, DINT_TO_USINT, DINT_TO_INT, DINT_TO_UINT, DINT_TO_UDINT, DINT_TO_REAL, DINT_TO_LREAL, DINT_TO_CHAR, DINT_TO_STRING | The value is converted. |
| | DINT_TO_DWORD, DINT_TO_TIME | The value is transferred to the target data type. |
| UDInt | UDINT_TO_BOOL | The least significant bit is transferred into the destination data type. |
| | UDINT_TO_BYTE, UDINT_TO_WORD, UDINT_TO_SINT, UDINT_TO_USINT, UDINT_TO_INT, UDINT_TO_UINT, UDINT_TO_DINT, UDINT_TO_REAL, UDINT_TO_LREAL, UDINT_TO_CHAR, UDINT_TO_STRING | The value is converted. |
| | UDINT_TO_DWORD, UDINT_TO_TOD | The value is transferred to the target data type. |

7.7 Conversion operations

Table 7- 80 Conversion from a Real number (Real or LReal)

| Data type | Instruction | Result |
|-----------|---|---|
| Real | REAL_TO_DWORD, REAL_TO_LREAL | The value is transferred to the target data type. |
| | REAL_TO_SINT, REAL_TO_USINT, REAL_TO_INT, REAL_TO_UINT, REAL_TO_DINT, REAL_TO_UDINT, REAL_TO_STRING | The value is converted. |
| LReal | LREAL_TO_SINT, LREAL_TO_USINT, LREAL_TO_INT, LREAL_TO_UINT, LREAL_TO_DINT, LREAL_TO_UDINT, LREAL_TO_REAL, LREAL_TO_STRING | The value is converted. |

Table 7- 81 Conversion from Time, DTL, TOD or Date



| Data type | Instruction | Result |
|-----------|-------------------------|---|
| Time | TIME_TO_DINT | The value is transferred to the target data type. |
| DTL | DTL_TO_DATE, DTL_TO_TOD | The value is converted. |
| TOD | TOD_TO_UDINT | The value is converted. |
| Date | DATE_TO_UINT | The value is converted. |

Table 7- 82 Conversion from a Char or String

| Data type | Instruction | Result |
|-----------|--|--|
| Char | CHAR_TO_SINT, CHAR_TO_USINT, CHAR_TO_INT, CHAR_TO_UINT, CHAR_TO_DINT, CHAR_TO_UDINT | The value is converted. |
| | CHAR_TO_STRING | The value is transferred to the first character of the string. |
| String | STRING_TO_SINT, STRING_TO_USINT, STRING_TO_INT, STRING_TO_UINT, STRING_TO_DINT, STRING_TO_UDINT, STRING_TO_REAL, STRING_TO_LREAL | The value is converted. |
| | STRING_TO_CHAR | The first character of the string is copied to the Char. |

7.7.3 ROUND (Round numerical value) and TRUNC (Truncate numerical value) instructions

Table 7- 83 ROUND and TRUNC instructions

| LAD / FBD | SCL | Description |
|--|-------------------------------|--|
|  | <pre>out := ROUND (in);</pre> | <p>Converts a real number to an integer. For LAD/FBD, you click the "???" in the instruction box to select the data type for the output, for example "DInt". For SCL, the default data type for the output of the ROUND instruction is DINT. To round to another output data type, enter the instruction name with the explicit name of the data type, for example, ROUND_REAL or ROUND_LREAL.</p> <p>The real number fraction is rounded to the nearest integer value (IEEE - round to nearest). If the number is exactly one-half the span between two integers (for example, 10.5), then the number is rounded to the even integer. For example:</p> <ul style="list-style-type: none"> • ROUND (10.5) = 10 • ROUND (11.5) = 12 |
|  | <pre>out := TRUNC (in);</pre> | <p>TRUNC converts a real number to an integer. The fractional part of the real number is truncated to zero (IEEE - round to zero).</p> |

1 For LAD and FBD: Click the "???" (by the instruction name) and select a data type from the drop-down menu.

Table 7- 84 Data types for the parameters



| Parameter | Data type | Description |
|-----------|---|-----------------------------|
| IN | Real, LReal | Floating point input |
| OUT | SInt, Int, DInt, USInt, UInt, UDIInt, Real, LReal | Rounded or truncated output |

Table 7- 85 ENO status

| ENO | Description | Result OUT |
|-----|--------------------------|--------------------|
| 1 | No error | Valid result |
| 0 | IN is +/- INF or +/- NaN | +/- INF or +/- NaN |

7.7.4 CEIL and FLOOR (Generate next higher and lower integer from floating-point number) instructions

Table 7- 86 CEIL and FLOOR instructions

| LAD / FBD | SCL | Description |
|---|------------------------------|--|
|  | <pre>out := CEIL(in);</pre> | Converts a real number (Real or LReal) to the closest integer greater than or equal to the selected real number (IEEE "round to +infinity"). |
|  | <pre>out := FLOOR(in);</pre> | Converts a real number (Real or LReal) to the closest integer smaller than or equal to the selected real number (IEEE "round to -infinity"). |

¹ For LAD and FBD: Click the "???" (by the instruction name) and select a data type from the drop-down menu.

Table 7- 87 Data types for the parameters

| Parameter | Data type | Description |
|-----------|---|----------------------|
| IN | Real, LReal | Floating point input |
| OUT | SInt, Int, DInt, USInt, UInt, UDIInt, Real, LReal | Converted output |

Table 7- 88 ENO status

| ENO | Description | Result OUT |
|-----|--------------------------|--------------------|
| 1 | No error | Valid result |
| 0 | IN is +/- INF or +/- NaN | +/- INF or +/- NaN |

7.7.5 SCALE_X (Scale) and NORM_X (Normalize) instructions

Table 7- 89 SCALE_X and NORM_X instructions

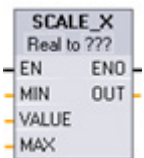
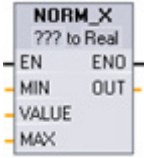
| LAD / FBD | SCL | Description |
|---|--|---|
|  | <pre>out :=SCALE_X(min:=_in_, value:=_in_, max:=_in_);</pre> | <p>Scales the normalized real parameter VALUE where (0.0 <= VALUE <= 1.0) in the data type and value range specified by the MIN and MAX parameters:</p> $OUT = VALUE (MAX - MIN) + MIN$ |
|  | <pre>out :=NORM_X(min:=_in_, value:=_in_, max:=_in_);</pre> | <p>Normalizes the parameter VALUE inside the value range specified by the MIN and MAX parameters:</p> $OUT = (VALUE - MIN) / (MAX - MIN),$ <p>where (0.0 <= OUT <= 1.0)</p> |

¹ For LAD and FBD: Click the "???" and select a data type from the drop-down menu.

Table 7- 90 Data types for the parameters

| Parameter | Data type ¹ | Description |
|-----------|--|-----------------------------------|
| MIN | SInt, Int, DInt, USInt, UInt, UDInt, Real, LReal | Input minimum value for range |
| VALUE | SCALE_X: Real, LReal NORM_X: SInt, Int, DInt, USInt, UInt, UDInt, Real, LReal | Input value to scale or normalize |
| MAX | SInt, Int, DInt, USInt, UInt, UDInt, Real, LReal | Input maximum value for range |
| OUT | SCALE_X: SInt, Int, DInt, USInt, UInt, UDInt, Real, LReal NORM_X: Real, LReal | Scaled or normalized output value |

¹ For SCALE_X: Parameters MIN, MAX, and OUT must be the same data type.
For NORM_X: Parameters MIN, VALUE, and MAX must be the same data type.

Note

SCALE_X parameter VALUE should be restricted to (0.0 <= VALUE <= 1.0)

If parameter VALUE is less than 0.0 or greater than 1.0:

- The linear scaling operation can produce OUT values that are less than the parameter MIN value or above the parameter MAX value for OUT values that fit within the value range of the OUT data type. SCALE_X execution sets ENO = TRUE for these cases.
- It is possible to generate scaled numbers that are not within the range of the OUT data type. For these cases, the parameter OUT value is set to an intermediate value equal to the least-significant portion of the scaled real number prior to final conversion to the OUT data type. SCALE_X execution sets ENO = FALSE in this case.

NORM_X parameter VALUE should be restricted to (MIN <= VALUE <= MAX)

If parameter VALUE is less than MIN or greater than MAX, the linear scaling operation can produce normalized OUT values that are less than 0.0 or greater than 1.0. NORM_X execution sets ENO = TRUE in this case.

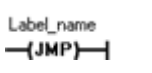

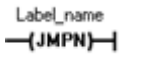



Table 7- 91 ENO status

| ENO | Condition | Result OUT |
|-----|--|---|
| 1 | No error | Valid result |
| 0 | Result exceeds valid range for the OUT data type | Intermediate result: The least-significant portion of a real number prior to final conversion to the OUT data type. |
| 0 | Parameters MAX <= MIN | SCALE_X: The least-significant portion of the Real number VALUE to fill up the OUT size. NORM_X: VALUE in VALUE data type extended to fill a double word size. |
| 0 | Parameter VALUE = +/- INF or +/- NaN | VALUE is written to OUT |

7.8 Program control operations

7.8.1 JMP (Jump if RLO = 1), JMPN (Jump if RLO = 0), and Label (Jump label) instructions

Table 7- 92 JMP, JMPN, and LABEL instruction

| LAD | FBD | SCL | Description |
|--|--|------------------------------------|---|
|  |  | See the GOTO (Page 274) statement. | Jump if RLO (result of logic operation) = 1: If there is power flow to a JMP coil (LAD), or if the JMP box input is true (FBD), then program execution continues with the first instruction following the specified label. |
|  |  | | Jump if RLO = 0: If there is no power flow to a JMPN coil (LAD), or if the JMPN box input is false (FBD), then program execution continues with the first instruction following the specified label. |
|  |  | | Destination label for a JMP or JMPN jump instruction. |

¹ You create your label names by typing in the LABEL instruction directly. Use the parameter helper icon to select the available label names for the JMP and JMPN label name field. You can also type a label name directly into the JMP or JMPN instruction.

Table 7- 93 Data types for the parameters

| Parameter | Data type | Description |
|------------|------------------|---|
| Label_name | Label identifier | Identifier for Jump instructions and the corresponding jump destination program label |

- Each label must be unique within a code block.
- You can jump within a code block, but you cannot jump from one code block to another code block.
- You can jump forward or backward.
- You can jump to the same label from more than one place in the same code block.

7.8.2 JMP_LIST (Define jump list) instruction

Table 7- 94 JMP_LIST instruction

| LAD / FBD | SCL | Description |
|---|--|---|
|  | <pre> CASE k OF 0: GOTO dest0; 1: GOTO dest1; 2: GOTO dest2; [n: GOTO destn;] END_CASE; </pre> | <p>The JMP_LIST instruction acts as a program jump distributor to control the execution of program sections. Depending on the value of the K input, a jump occurs to the corresponding program label. Program execution continues with the program instructions that follow the destination jump label. If the value of the K input exceeds the number of labels - 1, then no jump occurs and processing continues with the next program network.</p> |

Table 7- 95 Data types for parameters

| Parameter | Data type | Description |
|---------------------------|----------------|--|
| K | UInt | Jump distributor control value |
| DEST0, DEST1, ..., DESTn. | Program Labels | Jump destination labels corresponding to specific K parameter values: If the value of K equals 0, then a jump occurs to the program label assigned to the DEST0 output. If the value of K equals 1, then a jump occurs to the program label assigned to the DEST1 output, and so on. If the value of the K input exceeds the (number of labels - 1), then no jump occurs and processing continues with the next program network. |

For LAD and FBD: When the JMP_LIST box is first placed in your program, there are two jump label outputs. You can add or delete jump destinations.

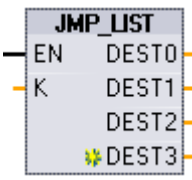

Click the create icon inside the box (on the left of the last DEST parameter) to add new outputs for jump labels.



- Right-click on an output stub and select the "Insert output" command.
- Right-click on an output stub and select the "Delete" command.

7.8.3 SWITCH (Jump distributor) instruction

Table 7- 96 SWITCH instruction

| LAD / FBD | SCL | Description |
|-----------|---------------|--|
| | Not available | The SWITCH instruction acts as a program jump distributor to control the execution of program sections. Depending on the result of comparisons between the value of the K input and the values assigned to the specified comparison inputs, a jump occurs to the program label that corresponds to the first comparison test that is true. If none of the comparisons is true, then a jump to the label assigned to ELSE occurs. Program execution continues with the program instructions that follow the destination jump label. |

- 1 For LAD and FBD: Click below the box name and select a data type from the drop-down menu.
- 2 For SCL: Use an IF-THEN set of comparisons.

Table 7- 97 Data types for parameters

| Parameter | Data type ¹ | Description |
|--------------------------------|--|---|
| K | SInt, Int, DInt, USInt, UInt, UDInt, Real, LReal, Byte, Word, DWord, Time, TOD, Date | Common comparison value input |
| ==, <>, <, <=, >, >= | SInt, Int, DInt, USInt, UInt, UDInt, Real, LReal, Byte, Word, DWord, Time, TOD, Date | Separate comparison value inputs for specific comparison types |
| DEST0, DEST1, ..., DESTn. ELSE | Program Labels | Jump destination labels corresponding to specific comparisons: The comparison input below and next to the K input is processed first and causes a jump to the label assigned to DEST0, if the comparison between the K value and this input is true. The next comparison test uses the next input below and causes a jump to the label assigned to DEST1, if the comparison is true. The remaining comparisons are processed similarly and if none of the comparisons are true, then a jump to the label assigned to the ELSE output occurs. |

¹ The K input and comparison inputs (==, <>, <, <=, >, >=) must be the same data type.

Adding inputs, deleting inputs, and specifying comparison types

When the LAD or FBD SWITCH box is first placed in your program there are two comparison inputs. You can assign comparison types and add inputs/jump destinations, as shown below.

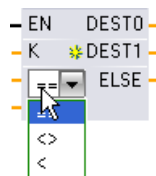

Click a comparison operator inside the box and select a new operator from the drop-down list.



Click the create icon inside the box (to the left of the last DEST parameter) to add new comparison-destination parameters.

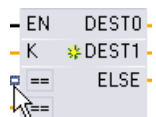

- Right-click on an input stub and select the "Insert input" command.
- Right-click on an input stub and select the "Delete" command.

Table 7- 98 SWITCH box data type selection and allowed comparison operations

| Data type | Comparison | Operator syntax |
|---|-----------------------|-----------------|
| Byte, Word, DWord | Equal | == |
| | Not equal | <> |
| SInt, Int, DInt, USInt, UInt, UDInt, Real, LReal, Time, TOD, Date | Equal | == |
| | Not equal | <> |
| | Greater than or equal | >= |
| | Less than or equal | <= |
| | Greater than | > |
| | Less than | < |

SWITCH box placement rules

- No LAD/FBD instruction connection in front of the compare input is allowed.
- There is no ENO output, so only one SWITCH instruction is allowed in a network and the SWITCH instruction must be the last operation in a network.

7.8.4 RET (Return) instruction

The optional RET instruction is used to terminate the execution of the current block. If and only if there is power flow to the RET coil (LAD) or if the RET box input is true (FBD), then program execution of the current block will end at that point and instructions beyond the RET instruction will not be executed. If the current block is an OB, the "Return_Value" parameter is ignored. If the current block is a FC or FB, the value of the "Return_Value " parameter is passed back to the calling routine as the ENO value of the called box.

You are not required to use a RET instruction as the last instruction in a block; this is done automatically for you. You can have multiple RET instructions within a single block.

For SCL, see the RETURN (Page 274) statement.

Table 7- 99 Return_Value (RET) execution control instruction



| LAD | FBD | SCL | Description |
|---|---|-----------------|--|
|  |  | <p>RETURN ;</p> | <p>Terminates the execution of the current block</p> |

Table 7- 100 Data types for the parameters

| Parameter | Data type | Description |
|--------------|-----------|---|
| Return_Value | Bool | The "Return_value" parameter of the RET instruction is assigned to the ENO output of the block call box in the calling block. |

Sample steps for using the RET instruction inside an FC code block:

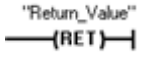
1. Create a new project and add an FC:
2. Edit the FC:
 - Add instructions from the instruction tree.
 - Add a RET instruction, including one of the following for the "Return_Value" parameter:
TRUE, FALSE, or a memory location that specifies the required return value.
 - Add more instructions.
3. Call the FC from MAIN [OB1].

The EN input on the FC box in the MAIN code block must be true to begin execution of the FC.

The value specified by the RET instruction in the FC will be present on the ENO output of the FC box in the MAIN code block following execution of the FC for which power flow to the RET instruction is true.

7.8.5 ENDIS_PW (Enable/disable CPU passwords) instruction

Table 7- 101 ENDIS_PW instruction

| LAD / FBD | SCL | Description |
|---|--|--|
|  | <pre> ENDIS_PW(req:=_bool_in_, f_pwd:=_bool_in_, full_pwd:=_bool_in_, r_pwd:=_bool_in_, hmi_pwd:=_bool_in_, f_pwd_on=>_bool_out_, full_pwd_on=>_bool_out_, r_pwd_on=>_bool_out_, hmi_pwd_on=>_bool_out_, </pre> | <p>The ENDIS_PW instruction can allow and disallow client connections to a S7-1200 CPU, even when the client can provide the correct password.</p> <p>This instruction does not disallow Web server passwords.</p> |

Table 7- 102 Data types for the parameters

| Parameter and type | Data type | Description | |
|--------------------|-----------|-------------|--|
| REQ | IN | Bool | Perform function if REQ=1 |
| F_PWD | IN | Bool | Failsafe password: Allow (=1) or disallow (=0) |
| FULL_PWD | IN | Bool | Full access password: Allow (=1) or disallow (=0) full access password |
| R_PWD | IN | Bool | Read access password: Allow (=1) or disallow (=0) |
| HMI_PWD | IN | Bool | HMI password: Allow (=1) or disallow (=0) |
| F_PWD_ON | OUT | Bool | Failsafe password status: Allowed (=1) or disallowed (=0) |
| FULL_PWD_ON | OUT | Bool | Full access password status: Allowed (=1) or disallowed (=0) |

| Parameter and type | | Data type | Description |
|--------------------|-----|-----------|--|
| R_PWD_ON | OUT | Bool | Read only password status: Allowed (=1) or disallowed (=0) |
| HMI_PWD_ON | OUT | Bool | HMI password status: Allowed (=1) or disallowed (=0) |
| Ret_Val | OUT | Word | Function result |

Calling `ENDIS_PW` with `REQ=1` disallows password types where the corresponding password input parameter is `FALSE`. Each password type can be allowed or disallowed independently. For example, if the fail-safe password is allowed and all other passwords disallowed, then you can restrict CPU access to a small group of employees.

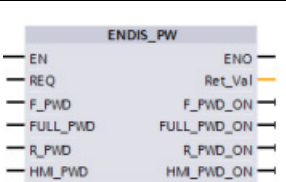
`ENDIS_PW` is executed synchronously in a program scan and the password output parameters always show the current state of password allowance independent of the input parameter `REQ`. All passwords that you set to allow must be changeable to disallowed/allowed. Otherwise, an error is returned and all passwords are allowed that were allowed before `ENDIS_PW` execution. This means that in a standard CPU (where the failsafe password is not configured) `F_PWD` must always be set to 1, to result in a return value of 0. In this case, `F_PWD_ON` is always 1.

Note

- `ENDIS_PW` execution can block the access of HMI devices, if the HMI password is disallowed.
- Client sessions that were authorized prior to `ENDIS_PW` execution remain unchanged by `ENDIS_PW` execution.

After a power-up, CPU access is restricted by passwords previously defined in the regular CPU protection configuration. The ability to disallow a valid password must be re-established with a new `ENDIS_PW` execution. However, if `ENDIS_PW` is immediately executed and necessary passwords are disallowed, then TIA portal access can be locked out. You can use a timer instruction to delay `ENDIS_PW` execution and allow time to enter passwords, before the passwords become disallowed.

Note

Restoring a CPU that locks out TIA portal communication

Refer to the "Recovery from a lost password (Page 136)" topic for details about how to erase the internal load memory of a PLC using a memory card.

An operating mode change to `STOP` caused by errors, `STP` execution or `STEP 7` does not abolish the protection. The protection is valid until the CPU is power cycled. See the following table for details.

| Action | Operating mode | ENDIS_PW password control |
|--|-------------------|---|
| After memory reset from <code>STEP 7</code> | <code>STOP</code> | Active: Disallowed passwords remain disallowed. |
| After powering on, or changing a memory card | <code>STOP</code> | Off: No passwords are disallowed. |

| Action | Operating mode | ENDIS_PW password control |
|--|----------------|---|
| After ENDIS_PW execution in a program cycle or startup OB | STARTUP, RUN | Active: Passwords are disallowed according to ENDIS_PW parameters |
| After change of the operating mode from RUN or STARTUP to STOP through STP instruction, error, or STEP 7 | STOP | Active: Disallowed passwords remain disallowed |

Note

Password protect CPU access levels with strong passwords. Strong passwords are at least eight characters in length, mix letters, numbers, and special characters, are not words that can be found in a dictionary, and are not names or identifiers that can be derived from personal information. Keep the password secret and change it frequently.

Table 7- 103 Condition codes

| RET_VAL (W#16#...) | Description |
|-----------------------|---|
| 0000 | No error |
| 80D0 | The password for fail-safe is not configured. |
| 80D1 | The password for read/write access is not configured. |
| 80D2 | The password for read access is not configured. |
| 80D3 | The password for HMI access is not configured. |

7.8.6 RE_TRIGR (Restart cycle monitoring time) instruction

Table 7- 104 RE_TRIGR instruction

| LAD / FBD | SCL | Description |
|---|----------------|--|
|  | RE_TRIGR () ; | RE_TRIGR (Re-trigger scan time watchdog) is used to extend the maximum time allowed before the scan cycle watchdog timer generates an error. |

Use the RE_TRIGR instruction to restart the scan cycle monitoring timer during a single scan cycle. This has the effect of extending the allowed maximum scan cycle time by one maximum cycle time period, from the last execution of the RE_TRIGR function.

Note

Prior to S7-1200 CPU firmware version 2.2, RE_TRIGR was restricted to execution from a program cycle OB and could be used to extend the PLC scan time indefinitely. ENO = FALSE and the watchdog timer is not reset when RE_TRIGR was executed from a start up OB, an interrupt OB, or an error OB.

For firmware version 2.2 and later, RE_TRIGR can be executed from any OB (including start up, interrupt, and error OBs). However, the PLC scan can only be extended by a maximum of 10x the configured maximum cycle time.

Setting the PLC maximum cycle time

Configure the value for maximum scan cycle time in the Device configuration for "Cycle time".

Table 7- 105 Cycle time values

| Cycle time monitor | Minimum value | Maximum value | Default value |
|--------------------|---------------|---------------|---------------|
| Maximum cycle time | 1 ms | 6000 ms | 150 ms |

Watchdog timeout

If the maximum scan cycle timer expires before the scan cycle has been completed, an error is generated. If the user program includes a time error interrupt OB (OB 80), the CPU executes the time error interrupt OB, which can include program logic to create a special reaction.

If the user program does not include a time error interrupt OB, the first timeout condition is ignored and the CPU remains in RUN mode. If a second maximum scan time timeout occurs in the same program scan (2 times the maximum cycle time value), then an error is triggered that causes a transition to STOP mode.

In STOP mode, your program execution stops while CPU system communications and system diagnostics continue.

7.8.7 STP (Exit program) instruction

Table 7- 106 STP instruction

| LAD / FBD | SCL | Description |
|---|----------------------|---|
|  | <pre>STP () ;</pre> | STP puts the CPU in STOP mode. When the CPU is in STOP mode, the execution of your program and physical updates from the process image are stopped. |

For more information see: Configuring the outputs on a RUN-to-STOP transition (Page 104).

If EN = TRUE, then the CPU goes to STOP mode, the program execution stops, and the ENO state is meaningless. Otherwise, EN = ENO = 0.

7.8.8 GET_ERROR and GET_ERROR_ID (Get error and error ID locally) instructions

The get error instructions provide information about program block execution errors. If you add a GET_ERROR or GET_ERROR_ID instruction to your code block, you can handle program errors within your program block.

GET_ERROR

Table 7- 107 GET_ERROR instruction

| LAD / FBD | SCL | Description |
|---|---------------------------------|--|
|  | <pre>GET_ERROR(_out_) ;</pre> | Indicates that a local program block execution error has occurred and fills a predefined error data structure with detailed error information. |

Table 7- 108 Data types for the parameters

| Parameter | Data type | Description |
|-----------|-------------|---|
| ERROR | ErrorStruct | Error data structure: You can rename the structure, but not the members within the structure. |

Table 7- 109 Elements of the ErrorStruct data structure

| Structure components | | Data type | Description | | | | | | | | | | | | | | | | | | | | | | | | | | | | | | | | | | | | | | | | | | | | | | | | | | | | | | |
|-------------------------|--------------|------------------|--|--------|--------|-----|-----|-----|-----|---|--|--|--|--|--|---|--|--|--|--|--------|---|--|--|------|--|--|---|----------|-------|--|--------|--|---|--|--|------|--|--------|---|--|--|------|--------|--------|---|--------------|--|------|--------|--------|---|--------------|------------------|------|--------|--------|
| ERROR_ID | | Word | Error ID | | | | | | | | | | | | | | | | | | | | | | | | | | | | | | | | | | | | | | | | | | | | | | | | | | | | | | |
| FLAGS | | Byte | Shows if an error occurred during a block call. <ul style="list-style-type: none"> • 16#01: Error during a block call. • 16#00: No error during a block call. | | | | | | | | | | | | | | | | | | | | | | | | | | | | | | | | | | | | | | | | | | | | | | | | | | | | | | |
| REACTION | | Byte | Default reaction: <ul style="list-style-type: none"> • 0: Ignore (write error), • 1: Continue with substitute value "0" (read error), • 2: Skip instruction (system error) | | | | | | | | | | | | | | | | | | | | | | | | | | | | | | | | | | | | | | | | | | | | | | | | | | | | | | |
| CODE_ADDRESS | | CREF | Information about the address and type of block | | | | | | | | | | | | | | | | | | | | | | | | | | | | | | | | | | | | | | | | | | | | | | | | | | | | | | |
| | BLOCK_TYPE | Byte | Type of block where the error occurred: <ul style="list-style-type: none"> • 1: OB • 2: FC • 3: FB | | | | | | | | | | | | | | | | | | | | | | | | | | | | | | | | | | | | | | | | | | | | | | | | | | | | | | |
| | CB_NUMBER | UInt | Number of the code block | | | | | | | | | | | | | | | | | | | | | | | | | | | | | | | | | | | | | | | | | | | | | | | | | | | | | | |
| | OFFSET | UDInt | Reference to the internal memory | | | | | | | | | | | | | | | | | | | | | | | | | | | | | | | | | | | | | | | | | | | | | | | | | | | | | | |
| MODE | | Byte | Access mode: Depending on the type of access, the following information can be output: | | | | | | | | | | | | | | | | | | | | | | | | | | | | | | | | | | | | | | | | | | | | | | | | | | | | | | |
| | | | <table border="1"> <thead> <tr> <th>Mode</th> <th>(A)</th> <th>(B)</th> <th>(C)</th> <th>(D)</th> <th>(E)</th> </tr> </thead> <tbody> <tr> <td>0</td> <td></td> <td></td> <td></td> <td></td> <td></td> </tr> <tr> <td>1</td> <td></td> <td></td> <td></td> <td></td> <td>Offset</td> </tr> <tr> <td>2</td> <td></td> <td></td> <td>Area</td> <td></td> <td></td> </tr> <tr> <td>3</td> <td>Location</td> <td>Scope</td> <td></td> <td>Number</td> <td></td> </tr> <tr> <td>4</td> <td></td> <td></td> <td>Area</td> <td></td> <td>Offset</td> </tr> <tr> <td>5</td> <td></td> <td></td> <td>Area</td> <td>DB no.</td> <td>Offset</td> </tr> <tr> <td>6</td> <td>PtrNo. / Acc</td> <td></td> <td>Area</td> <td>DB no.</td> <td>Offset</td> </tr> <tr> <td>7</td> <td>PtrNo. / Acc</td> <td>Slot No. / Scope</td> <td>Area</td> <td>DB no.</td> <td>Offset</td> </tr> </tbody> </table> | Mode | (A) | (B) | (C) | (D) | (E) | 0 | | | | | | 1 | | | | | Offset | 2 | | | Area | | | 3 | Location | Scope | | Number | | 4 | | | Area | | Offset | 5 | | | Area | DB no. | Offset | 6 | PtrNo. / Acc | | Area | DB no. | Offset | 7 | PtrNo. / Acc | Slot No. / Scope | Area | DB no. | Offset |
| Mode | (A) | (B) | (C) | (D) | (E) | | | | | | | | | | | | | | | | | | | | | | | | | | | | | | | | | | | | | | | | | | | | | | | | | | | | |
| 0 | | | | | | | | | | | | | | | | | | | | | | | | | | | | | | | | | | | | | | | | | | | | | | | | | | | | | | | | | |
| 1 | | | | | Offset | | | | | | | | | | | | | | | | | | | | | | | | | | | | | | | | | | | | | | | | | | | | | | | | | | | | |
| 2 | | | Area | | | | | | | | | | | | | | | | | | | | | | | | | | | | | | | | | | | | | | | | | | | | | | | | | | | | | | |
| 3 | Location | Scope | | Number | | | | | | | | | | | | | | | | | | | | | | | | | | | | | | | | | | | | | | | | | | | | | | | | | | | | | |
| 4 | | | Area | | Offset | | | | | | | | | | | | | | | | | | | | | | | | | | | | | | | | | | | | | | | | | | | | | | | | | | | | |
| 5 | | | Area | DB no. | Offset | | | | | | | | | | | | | | | | | | | | | | | | | | | | | | | | | | | | | | | | | | | | | | | | | | | | |
| 6 | PtrNo. / Acc | | Area | DB no. | Offset | | | | | | | | | | | | | | | | | | | | | | | | | | | | | | | | | | | | | | | | | | | | | | | | | | | | |
| 7 | PtrNo. / Acc | Slot No. / Scope | Area | DB no. | Offset | | | | | | | | | | | | | | | | | | | | | | | | | | | | | | | | | | | | | | | | | | | | | | | | | | | | |
| OPERAND_NUMBER | | UInt | Operand number of the machine command | | | | | | | | | | | | | | | | | | | | | | | | | | | | | | | | | | | | | | | | | | | | | | | | | | | | | | |
| POINTER_NUMBER_LOCATION | | UInt | (A) Internal pointer | | | | | | | | | | | | | | | | | | | | | | | | | | | | | | | | | | | | | | | | | | | | | | | | | | | | | | |
| SLOT_NUMBER_SCOPE | | UInt | (B) Storage area in internal memory | | | | | | | | | | | | | | | | | | | | | | | | | | | | | | | | | | | | | | | | | | | | | | | | | | | | | | |
| DATA_ADDRESS | | NREF | Information about the address of an operand | | | | | | | | | | | | | | | | | | | | | | | | | | | | | | | | | | | | | | | | | | | | | | | | | | | | | | |
| | AREA | Byte | (C) Memory area: <ul style="list-style-type: none"> • L: 16#40 – 4E, 86, 87, 8E, 8F, C0 – CE • I: 16#81 • Q: 16#82 • M: 16#83 • DB: 16#84, 85, 8A, 8B | | | | | | | | | | | | | | | | | | | | | | | | | | | | | | | | | | | | | | | | | | | | | | | | | | | | | | |

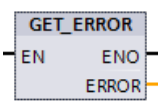
| Structure components | | Data type | Description |
|----------------------|-----------|-----------|-------------------------------------|
| | DB_NUMBER | UInt | (D) Number of the data block |
| | OFFSET | UDInt | (E) Relative address of the operand |

GET_ERROR_ID

Table 7- 110 GetErrorID instruction

| LAD / FBD | SCL | Description |
|---|---------------------------|--|
|  | <pre>GET_ERR_ID ();</pre> | Indicates that a program block execution error has occurred and reports the ID (identifier code) of the error. |

Table 7- 111 Data types for the parameters

| Parameter | Data type | Description |
|-----------|-----------|---|
| ID | Word | Error identifier values for the ErrorStruct ERROR_ID member |

Table 7- 112 Error_ID values

| ERROR_ID hexadecimal | ERROR_ID decimal | Program block execution error |
|----------------------|------------------|--|
| 0 | 0 | No error |
| 2520 | 9504 | Corrupted string |
| 2522 | 9506 | Operand out of range read error |
| 2523 | 9507 | Operand out of range write error |
| 2524 | 9508 | Invalid area read error |
| 2525 | 9509 | Invalid area write error |
| 2528 | 9512 | Data alignment read error (incorrect bit alignment) |
| 2529 | 9513 | Data alignment write error (incorrect bit alignment) |
| 252C | 9516 | Uninitialized pointer error |
| 2530 | 9520 | DB write protected |
| 253A | 9530 | Global DB does not exist |
| 253C | 9532 | Wrong version or FC does not exist |
| 253D | 9533 | Instruction does not exist |
| 253E | 9534 | Wrong version or FB does not exist |
| 253F | 9535 | Instruction does not exist |
| 2575 | 9589 | Program nesting depth error |
| 2576 | 9590 | Local data allocation error |
| 2942 | 10562 | Physical input point does not exist |
| 2943 | 10563 | Physical output point does not exist |

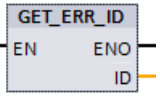
Operation

By default, the CPU responds to a block execution error by logging an error in the diagnostics buffer. However, if you place one or more `GET_ERROR` or `GET_ERROR_ID` instructions within a code block, this block is now set to handle errors within the block. In this case, the CPU does not log an error in the diagnostics buffer. Instead, the error information is reported in the output of the `GET_ERROR` or `GET_ERROR_ID` instruction. You can read the detailed error information with the `GET_ERROR` instruction, or read just the error identifier with `GET_ERROR_ID` instruction. Normally the first error is the most important, with the following errors only consequences of the first error.

The first execution of a `GET_ERROR` or `GET_ERROR_ID` instruction within a block returns the first error detected during block execution. This error could have occurred anywhere between the start of the block and the execution of either `GET_ERROR` or `GET_ERROR_ID`. Subsequent executions of either `GET_ERROR` or `GET_ERROR_ID` return the first error since the previous execution of `GET_ERROR` or `GET_ERROR_ID`. The history of errors is not saved, and execution of either instruction will re-arm the PLC system to catch the next error.

The `ErrorStruct` data type used by the `GET_ERROR` instruction can be added in the data block editor and block interface editors, so your program logic can access these values. Select `ErrorStruct` from the data type drop-down list to add this structure. You can create multiple `ErrorStruct` elements by using unique names. The members of an `ErrorStruct` cannot be renamed.

Error condition indicated by ENO

If `EN = TRUE` and `GET_ERROR` or `GET_ERROR_ID` executes, then:

- `ENO = TRUE` indicates a code block execution error occurred and error data is present
- `ENO = FALSE` indicates no code block execution error occurred

You can connect error reaction program logic to `ENO` which activates after an error occurs. If an error exists, then the output parameter stores the error data where your program has access to it.

`GET_ERROR` and `GET_ERROR_ID` can be used to send error information from the currently executing block (called block) to a calling block. Place the instruction in the last network of the called block program to report the final execution status of the called block.

7.8.9 SCL program control statements

7.8.9.1 Overview of SCL program control statements

Structured Control Language (SCL) provides three types of program control statements for structuring your user program:

- Selective statements: A selective statement enables you to direct program execution into alternative sequences of statements.
- Loops: You can control loop execution using iteration statements. An iteration statement specifies which parts of a program should be iterated depending on certain conditions.
- Program jumps: A program jump means an immediate jump to a specified jump destination and therefore to a different statement within the same block.

These program control statements use the syntax of the PASCAL programming language.

Table 7- 113 Types of SCL program control statements

| Program control statement | | Description |
|---------------------------|--------------------------------------|--|
| Selective | IF-THEN statement (Page 268) | Enables you to direct program execution into one of two alternative branches, depending on a condition being TRUE or FALSE |
| | CASE statement (Page 269) | Enables the selective execution into 1 of n alternative branches, based on the value of a variable |
| Loop | FOR statement (Page 270) | Repeats a sequence of statements for as long as the control variable remains within the specified value range |
| | WHILE-DO statement (Page 271) | Repeats a sequence of statements while an execution condition continues to be satisfied |
| | REPEAT-UNTIL statement (Page 272) | Repeats a sequence of statements until a terminate condition is met |
| Program jump | CONTINUE statement (Page 273) | Stops the execution of the current loop iteration |
| | EXIT statement (Page 273) | Exits a loop at any point regardless of whether the terminate condition is satisfied or not |
| | GOTO statement (Page 274) | Causes the program to jump immediately to a specified label |
| | RETURN statement (Page 274) | Causes the program to exit the block currently being executed and to return to the calling block |

7.8.9.2 IF-THEN statement

The IF-THEN statement is a conditional statement that controls program flow by executing a group of statements, based on the evaluation of a Bool value of a logical expression. You can also use brackets to nest or structure the execution of multiple IF-THEN statements.

Table 7- 114 Elements of the IF-THEN statement

| SCL | Description |
|---|---|
| <pre>IF "condition" THEN statement_A; statement_B; statement_C; ;</pre> | <p>If "condition" is TRUE or 1, then execute the following statements until encountering the END_IF statement.</p> <p>If "condition" is FALSE or 0, then skip to END_IF statement (unless the program includes optional ELSIF or ELSE statements).</p> |
| <pre>[ELSIF "condition-n" THEN statement_N; ;]</pre> | <p>The optional ELSEIF¹ statement provides additional conditions to be evaluated. For example: If "condition" in the IF-THEN statement is FALSE, then the program evaluates "condition-n". If "condition-n" is TRUE, then execute "statement_N".</p> |
| <pre>[ELSE statement_X; ;]</pre> | <p>The optional ELSE statement provides statements to be executed when the "condition" of the IF-THEN statement is FALSE.</p> |
| <pre>END_IF;</pre> | <p>The END_IF statement terminates the IF-THEN instruction.</p> |

¹ You can include multiple ELSIF statements within one IF-THEN statement.

Table 7- 115 Variables for the IF-THEN statement

| Variables | Description |
|---------------|---|
| "condition" | Required. The logical expression is either TRUE (1) or FALSE (0). |
| "statement_A" | Optional. One or more statements to be executed when "condition" is TRUE. |
| "condition-n" | Optional. The logical expression to be evaluated by the optional ELSIF statement. |
| "statement_N" | Optional. One or more statements to be executed when "condition-n" of the ELSIF statement is TRUE. |
| "statement_X" | Optional. One or more statements to be executed when "condition" of the IF-THEN statement is FALSE. |

An IF statement is executed according to the following rules:

- The first sequence of statements whose logical expression = TRUE is executed. The remaining sequences of statements are not executed.
- If no Boolean expression = TRUE, the sequence of statements introduced by ELSE is executed (or no sequence of statements if the ELSE branch does not exist).
- Any number of ELSIF statements can exist.

Note

Using one or more ELSIF branches has the advantage that the logical expressions following a valid expression are no longer evaluated in contrast to a sequence of IF statements. The runtime of a program can therefore be reduced.

7.8.9.3 CASE statement

Table 7- 116 Elements of the CASE statement

| SCL | Description |
|---|---|
| <pre> CASE "Test_Value" OF "ValueList": Statement[; Statement, ...] "ValueList": Statement[; Statement, ...] [ELSE Else-statement[; Else-statement, ...]] END CASE;</pre> | The CASE statement executes one of several groups of statements, depending on the value of an expression. |

Table 7- 117 Parameters

| Parameter | Description |
|----------------|---|
| "Test_Value" | Required. Any numeric expression of data type Int |
| "ValueList" | Required. A single value or a comma-separated list of values or ranges of values. (Use two periods to define a range of values: 2..8) The following example illustrates the different variants of the value list: 1: Statement_A; 2, 4: Statement_B; 3, 5..7,9: Statement_C; |
| Statement | Required. One or more statements that are executed when "Test_Value" matches any value in the value list |
| Else-statement | Optional. One or more statements that are executed if no match with a value of the "ValueList" stated matches |

The CASE statement is executed according to the following rules:

- The Test_value expression must return a value of the type Int.
- When a CASE statement is processed, the program checks whether the value of the Test_value expression is contained within a specified list of values. If a match is found, the statement component assigned to the list is executed.
- If no match is found, the program section following ELSE is executed or no statement is executed if the ELSE branch does not exist.

CASE statements can be nested. Each nested case statement must have an associated END_CASE statement.

```

CASE "var1" OF
    1 : #var2 := 'A';
    2 : #var2 := 'B';
ELSE
    CASE "var3" OF

        65..90: #var2 := 'UpperCase';
        97..122: #var2 := 'LowerCase';

    ELSE

        #var2:= 'SpecialCharacter';

    END_CASE;
END_CASE;
    
```

7.8.9.4 FOR statement

Table 7- 118 Elements of the FOR statement

| SCL | Description |
|---|--|
| <pre> FOR "control_variable" := "begin" TO "end" [BY "increment"] DO statement; ; END_FOR; </pre> | <p>A FOR statement is used to repeat a sequence of statements as long as a control variable is within the specified range of values. The definition of a loop with FOR includes the specification of an initial and an end value. Both values must be the same type as the control variable.</p> <p>You can nest FOR loops. The END_FOR statement refers to the last executed FOR instruction.</p> |

Table 7- 119 Parameters

| Parameter | Description |
|--------------------|---|
| "control_variable" | Required. An integer (Int or DInt) that serves as a loop counter |
| "begin" | Required. Simple expression that specifies the initial value of the control variables |
| "end" | Required. Simple expression that determines the final value of the control variables |
| "increment" | Optional. Amount by which a "control variable" is changed after each loop. The "increment" has the same data type as "control variable". If the "increment" value is not specified, then the value of the run tags will be increased by 1 after each loop. You cannot change "increment" during the execution of the FOR statement. |

The FOR statement executes as follows:

- At the start of the loop, the control variable is set to the initial value (initial assignment) and each time the loop iterates, it is incremented by the specified increment (positive increment) or decremented (negative increment) until the final value is reached.
- Following each run through of the loop, the condition is checked (final value reached) to establish whether or not it is satisfied. If the end condition is not satisfied, the sequence of statements is executed again, otherwise the loop terminates and execution continues with the statement immediately following the loop.

Rules for formulating FOR statements:

- The control variable may only be of the data type Int or DInt.
- You can omit the statement BY [increment]. If no increment is specified, it is automatically assumed to be +1.

To end the loop regardless of the state of the "condition" expression, use the EXIT statement (Page 273). The EXIT statement executes the statement immediately following the END_FOR statement.

Use the CONTINUE statement (Page 273) to skip the subsequent statements of a FOR loop and to continue the loop with the examination of whether the condition is met for termination.

7.8.9.5 WHILE-DO statement

Table 7- 120 WHILE statement

| SCL | Description |
|--|---|
| <pre>WHILE "condition" DO Statement; Statement; . . . ; END WHILE;</pre> | <p>The WHILE statement performs a series of statements until a given condition is TRUE.</p> <p>You can nest WHILE loops. The END_WHILE statement refers to the last executed WHILE instruction.</p> |

Table 7- 121 Parameters

| Parameter | Description |
|-------------|---|
| "condition" | Required. A logical expression that evaluates to TRUE or FALSE. (A "null" condition is interpreted as FALSE.) |
| Statement | Optional. One or more statements that are executed until the condition evaluates to TRUE. |

Note

The WHILE statement evaluates the state of "condition" before executing any of the statements. To execute the statements at least one time regardless of the state of "condition", use the REPEAT statement (Page 272).

The WHILE statement executes according to the following rules:

- Prior to each iteration of the loop body, the execution condition is evaluated.
- The loop body following DO iterates as long as the execution condition has the value TRUE.
- Once the value FALSE occurs, the loop is skipped and the statement following the loop is executed.

To end the loop regardless of the state of the "condition" expression, use the EXIT statement (Page 273). The EXIT statement executes the statement immediately following the END_WHILE statement

Use the CONTINUE statement to skip the subsequent statements of a WHILE loop and to continue the loop with the examination of whether the condition is met for termination.

7.8.9.6 REPEAT-UNTIL statement

Table 7- 122 REPEAT instruction

| SCL | Description |
|---|---|
| <pre> REPEAT Statement; ; UNTIL "condition" END_REPEAT;</pre> | <p>The REPEAT statement executes a group of statements until a given condition is TRUE.</p> <p>You can nest REPEAT loops. The END_REPEAT statement always refers to the last executed Repeat instruction.</p> |

Table 7- 123 Parameters

| Parameter | Description |
|-------------|---|
| Statement | Optional. One or more statements that are executed until the condition is TRUE. |
| "condition" | Required. One or more expressions of the two following ways: A numeric expression or string expression that evaluates to TRUE or FALSE. A "null" condition is interpreted as FALSE. |

Note

Before evaluating the state of "condition", the REPEAT statement executes the statements during the first iteration of the loop (even if "condition" is FALSE). To review the state of "condition" before executing the statements, use the WHILE statement (Page 271).

To end the loop regardless of the state of the "condition" expression, use the EXIT statement (Page 273). The EXIT statement executes the statement immediately following the END_REPEAT statement

Use the CONTINUE statement (Page 273) to skip the subsequent statements of a REPEAT loop and to continue the loop with the examination of whether the condition is met for termination.

7.8.9.7 CONTINUE statement

Table 7- 124 CONTINUE statement

| SCL | Description |
|------------------------------------|---|
| CONTINUE Statement; ; | The CONTINUE statement skips the subsequent statements of a program loop (FOR, WHILE, REPEAT) and continues the loop with the examination of whether the condition is met for termination. If this is not the case, the loop continues. |

The CONTINUE statement executes according to the following rules:

- This statement immediately terminates execution of a loop body.
- Depending on whether the condition for repeating the loop is satisfied or not the body is executed again or the iteration statement is exited and the statement immediately following is executed.
- In a FOR statement, the control variable is incremented by the specified increment immediately after a CONTINUE statement.

Use the CONTINUE statement only within a loop. In nested loops CONTINUE always refers to the loop that includes it immediately. CONTINUE is typically used in conjunction with an IF statement.

If the loop is to exit regardless of the termination test, use the EXIT statement.

The following example shows the use of the CONTINUE statement to avoid a division-by-0 error when calculating the percentage of a value:

```
FOR i := 0 TO 10 DO
  IF value[i] = 0 THEN CONTINUE; END_IF;
  p := part / value[i] * 100;
  s := INT_TO_STRING(p);
  percent := CONCAT(IN1:=s, IN2:="%");
END_FOR;
```

7.8.9.8 EXIT statement

Table 7- 125 EXIT instruction

| SCL | Description |
|--------------|---|
| EXIT; | An EXIT statement is used to exit a loop (FOR, WHILE or REPEAT) at any point, regardless of whether the terminate condition is satisfied. |

The EXIT statement executes according to the following rules:

- This statement causes the repetition statement immediately surrounding the exit statement to be exited immediately.
- Execution of the program is continued after the end of the loop (for example after END_FOR).

Use the EXIT statement within a loop. In nested loops, the EXIT statement returns the processing to the next higher nesting level.

```
FOR i := 0 TO 10 DO
CASE value[i, 0] OF
  1..10: value [i, 1]:="A";
  11..40: value [i, 1]:="B";
  41..100: value [i, 1]:="C";
ELSE
EXIT;
END_CASE;
END_FOR;
```

7.8.9.9 GOTO statement

Table 7- 126 GOTO statement

| SCL | Description |
|---|---|
| <pre>GOTO JumpLabel; Statement; ... ; JumpLabel: Statement;</pre> | <p>The GOTO statement skips over statements by jumping to a label in the same block.</p> <p>The jump label ("JumpLabel") and the GOTO statement must be in the same block. The name of a jump label can only be assigned once within a block. Each jump label can be the target of several GOTO statements.</p> |

It is not possible to jump to a loop section (FOR, WHILE or REPEAT). It is possible to jump from within a loop.

In the following example: Depending on the value of the "Tag_value" operand, the execution of the program resumes at the point defined by the corresponding jump label. If "Tag_value" equals 2, the program execution resumes at the jump label "MyLabel2" and skips "MyLabel1".

```
CASE "Tag_value" OF
  1 : GOTO MyLabel1;
  2 : GOTO MyLabel2;
ELSE GOTO MyLabel3;
END_CASE;
MyLabel1: "Tag_1" := 1;
MyLabel2: "Tag_2" := 1;
MyLabel3: "Tag_4" := 1;
```

7.8.9.10 RETURN statement

Table 7- 127 RETURN instruction

| SCL | Description |
|--------------------|---|
| <pre>RETURN;</pre> | <p>The Return instruction exits the code block being executed without conditions. Program execution returns to the calling block or to the operating system (when exiting an OB).</p> |

Example of a RETURN instruction:

```
IF "Error" <> 0 THEN
RETURN;
END_IF;
```

Note

After executing the last instruction, the code block automatically returns to the calling block. Do not insert a RETURN instruction at the end of the code block.

7.9 Word logic operations

7.9.1 AND, OR, and XOR logic operation instructions

Table 7- 128 AND, OR, and XOR logic operation instructions

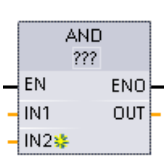
| LAD / FBD | SCL | Description |
|--|----------------------------------|---------------------------|
|  | <code>out := in1 AND in2;</code> | AND: Logical AND |
| | <code>out := in1 OR in2;</code> | OR: Logical OR |
| | <code>out := in1 XOR in2;</code> | XOR: Logical exclusive OR |

¹ For LAD and FBD: Click the "???" and select a data type from the drop-down menu.



To add an input, click the "Create" icon or right-click on an input stub for one of the existing IN parameters and select the "Insert input" command.

To remove an input, right-click on an input stub for one of the existing IN parameters (when there are more than the original two inputs) and select the "Delete" command.

Table 7- 129 Data types for the parameters

| Parameter | Data type | Description |
|-----------|-------------------|----------------|
| IN1, IN2 | Byte, Word, DWord | Logical inputs |
| OUT | Byte, Word, DWord | Logical output |

¹ The data type selection sets parameters IN1, IN2, and OUT to the same data type.

The corresponding bit values of IN1 and IN2 are combined to produce a binary logic result at parameter OUT. ENO is always TRUE following the execution of these instructions.

7.9.2 INV (Create ones complement) instruction

Table 7- 130 INV instruction

| LAD / FBD | SCL | Description |
|-----------|---------------|--|
| | Not available | Calculates the binary one's complement of the parameter IN. The one's complement is formed by inverting each bit value of the IN parameter (changing each 0 to 1 and each 1 to 0). ENO is always TRUE following the execution of this instruction. |

¹ For LAD and FBD: Click the "???" and select a data type from the drop-down menu.

Table 7- 131 Data types for the parameters

| Parameter | Data type | Description |
|-----------|--|------------------------|
| IN | SInt, Int, DInt, USInt, UInt, UDInt, Byte, Word, DWord | Data element to invert |
| OUT | SInt, Int, DInt, USInt, UInt, UDInt, Byte, Word, DWord | Inverted output |

7.9.3 DECO (Decode) and ENCO (Encode) instructions

Table 7- 132 ENCO and DECO instruction

| LAD / FBD | SCL | Description |
|-----------|---------------------------------|--|
| | <code>out := ENCO(_in_);</code> | <p>Encodes a bit pattern to a binary number</p> <p>The ENCO instruction converts parameter IN to the binary number corresponding to the bit position of the least-significant set bit of parameter IN and returns the result to parameter OUT. If parameter IN is either 0000 0001 or 0000 0000, then a value of 0 is returned to parameter OUT. If the parameter IN value is 0000 0000, then ENO is set to FALSE.</p> |
| | <code>out := DECO(_in_);</code> | <p>Decodes a binary number to a bit pattern</p> <p>The DECO instruction decodes a binary number from parameter IN, by setting the corresponding bit position in parameter OUT to a 1 (all other bits are set to 0). ENO is always TRUE following execution of the DECO instruction.</p> <p>Note: The default data type for the DECO instruction is DWORD. In SCL, change the instruction name to DECO_BYTE or DECO_WORD to decode a byte or word value, and assign to a byte or word tag or address.</p> |

¹ For LAD and FBD: Click the "???" and select a data type from the drop-down menu.

Table 7- 133 Data types for the parameters

| Parameter | Data type | Description |
|-----------|---------------------------------------|--|
| IN | ENCO: Byte, Word, DWord DECO: UInt | ENCO: Bit pattern to encode DECO: Value to decode |
| OUT | ENCO: Int DECO: Byte, Word, DWord | ENCO: Encoded value DECO: Decoded bit pattern |

Table 7- 134 ENO status

| ENO | Condition | Result (OUT) |
|-----|------------|--------------------|
| 1 | No error | Valid bit number |
| 0 | IN is zero | OUT is set to zero |

The DECO parameter OUT data type selection of a Byte, Word, or DWord restricts the useful range of parameter IN. If the value of parameter IN exceeds the useful range, then a modulo operation is performed to extract the least significant bits shown below.

DECO parameter IN range:

- 3 bits (values 0-7) IN are used to set 1 bit position in a Byte OUT
- 4-bits (values 0-15) IN are used to set 1 bit position in a Word OUT
- 5 bits (values 0-31) IN are used to set 1 bit position in a DWord OUT

Table 7- 135 Examples

| DECO IN value | | | DECO OUT value (Decode single bit position) |
|----------------------|---------|----|--|
| Byte OUT 8 bits | Min. IN | 0 | 00000001 |
| | Max. IN | 7 | 10000000 |
| Word OUT 16 bits | Min. IN | 0 | 0000000000000001 |
| | Max. IN | 15 | 1000000000000000 |
| DWord OUT 32 bits | Min. IN | 0 | 00000000000000000000000000000001 |
| | Max. IN | 31 | 10000000000000000000000000000000 |

7.9.4 SEL (Select), MUX (Multiplex), and DEMUX (Demultiplex) instructions

Table 7- 136 SEL (select) instruction

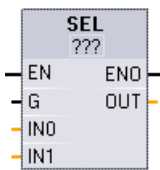
| LAD / FBD | SCL | Description |
|---|--|---|
|  | <pre>out := SEL(g:=_bool_in, in0:=_variant_in, in1:=_variant_in);</pre> | SEL assigns one of two input values to parameter OUT, depending on the parameter G value. |

¹ For LAD and FBD: Click the "???" and select a data type from the drop-down menu.

Table 7- 137 Data types for the SEL instruction

| Parameter | Data type ¹ | Description |
|-----------|---|--|
| G | Bool | <ul style="list-style-type: none"> • 0 selects IN0 • 1 selects IN1 |
| IN0, IN1 | SInt, Int, DInt, USInt, UInt, UDInt, Real, LReal, Byte, Word, DWord, Time, Char | Inputs |
| OUT | SInt, Int, DInt, USInt, UInt, UDInt, Real, LReal, Byte, Word, DWord, Time, Char | Output |

¹ Input variables and the output variable must be of the same data type.

Condition codes: ENO is always TRUE following execution of the SEL instruction.

Table 7- 138 MUX (multiplex) instruction

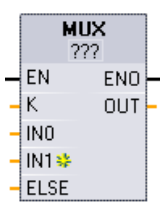
| LAD / FBD | SCL | Description |
|---|---|---|
|  | <pre>out := MUX(k:=_unit_in, in1:=variant_in, in2:=variant_in, [...in32:=variant_in,] inelse:=variant_in);</pre> | MUX copies one of many input values to parameter OUT, depending on the parameter K value. If the parameter K value exceeds (INn - 1), then the parameter ELSE value is copied to parameter OUT. |

¹ For LAD and FBD: Click the "???" and select a data type from the drop-down menu.



To add an input, click the "Create" icon or right-click on an input stub for one of the existing IN parameters and select the "Insert input" command.

To remove an input, right-click on an input stub for one of the existing IN parameters (when there are more than the original two inputs) and select the "Delete" command.

Table 7- 139 Data types for the MUX instruction

| Parameter | Data type | Description |
|------------------|--|---|
| K | UInt | <ul style="list-style-type: none"> • 0 selects IN1 • 1 selects IN2 • <i>n</i> selects IN<i>n</i> |
| IN0, IN1, .. INn | SInt, Int, DInt, USInt, UInt, UDIInt, Real, LReal, Byte, Word, DWord, Time, Char | Inputs |
| ELSE | SInt, Int, DInt, USInt, UInt, UDIInt, Real, LReal, Byte, Word, DWord, Time, Char | Input substitute value (optional) |
| OUT | SInt, Int, DInt, USInt, UInt, UDIInt, Real, LReal, Byte, Word, DWord, Time, Char | Output |

¹ Input variables and the output variable must be of the same data type.

Table 7- 140 DEMUX (Demultiplex) instruction

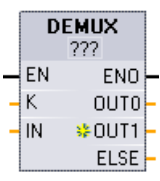
| LAD / FBD | SCL | Description |
|--|---|--|
|  | <pre> DEMUX (k:=_unit_in, in:=variant_in, out1:=variant_in, out2:=variant_in, [...out32:=variant_in,] outelse:=variant_in); </pre> | DEMUX copies the value of the location assigned to parameter IN to one of many outputs. The value of the K parameter selects which output selected as the destination of the IN value. If the value of K is greater than the number (OUT <i>n</i> - 1) then the IN value is copied to location assigned to the ELSE parameter. |

¹ For LAD and FBD: Click the "???" and select a data type from the drop-down menu.



To add an output, click the "Create" icon or right-click on an output stub for one of the existing OUT parameters and select the "Insert output" command.

To remove an output, right-click on an output stub for one of the existing OUT parameters (when there are more than the original two outputs) and select the "Delete" command.

Table 7- 141 Data types for the DEMUX instruction

| Parameter | Data type ¹ | Description |
|---------------------|--|--|
| K | UInt | Selector value: <ul style="list-style-type: none"> • 0 selects OUT1 • 1 selects OUT2 • n selects OUTn |
| IN | SInt, Int, DInt, USInt, UInt, UDIInt, Real, LReal, Byte, Word, DWord, Time, Char | Input |
| OUT0, OUT1, .. OUTn | SInt, Int, DInt, USInt, UInt, UDIInt, Real, LReal, Byte, Word, DWord, Time, Char | Outputs |
| ELSE | SInt, Int, DInt, USInt, UInt, UDIInt, Real, LReal, Byte, Word, DWord, Time, Char | Substitute output when K is greater than (OUTn - 1) |

¹ The input variable and the output variables must be of the same data type.

Table 7- 142 ENO status for the MUX and DEMUX instructions

| ENO | Condition | Result OUT |
|-----|---|--|
| 1 | No error | MUX: Selected IN value is copied to OUT DEMUX: IN value is copied to selected OUT |
| 0 | MUX: K is greater than the number of inputs -1 | <ul style="list-style-type: none"> • No ELSE provided: OUT is unchanged, • ELSE provided, ELSE value assigned to OUT |
| | DEMUX: K is greater than the number of outputs -1 | <ul style="list-style-type: none"> • No ELSE provided: outputs are unchanged, • ELSE provided, IN value copied to ELSE |

7.10 Shift and rotate

7.10.1 SHR (Shift right) and SHL (Shift left) instructions

Table 7- 143 SHR and SHL instructions

| LAD / FBD | SCL | Description |
|---|--|--|
|  | <pre> out := SHR (in:=_variant_in_, n:=_uint_in_); out := SHL (in:=_variant_in_, n:=_uint_in_); </pre> | Use the shift instructions (SHL and SHR) to shift the bit pattern of parameter IN. The result is assigned to parameter OUT. Parameter N specifies the number of bit positions shifted: <ul style="list-style-type: none"> • SHR: Shift bit pattern right • SHL: Shift bit pattern left |

1 For LAD and FBD: Click the "???" and select the data types from the drop-down menu.

Table 7- 144 Data types for the parameters

| Parameter | Data type | Description |
|-----------|-------------------|-----------------------------------|
| IN | Byte, Word, DWord | Bit pattern to shift |
| N | UInt | Number of bit positions to shift |
| OUT | Byte, Word, DWord | Bit pattern after shift operation |

- For N=0, no shift occurs. The IN value is assigned to OUT.
- Zeros are shifted into the bit positions emptied by the shift operation.
- If the number of positions to shift (N) exceeds the number of bits in the target value (8 for Byte, 16 for Word, 32 for DWord), then all original bit values will be shifted out and replaced with zeros (zero is assigned to OUT).
- ENO is always TRUE for the shift operations.

Table 7- 145 SHL example for Word data

| Shift the bits of a Word to the left by inserting zeroes from the right (N = 1) | | | |
|---|---------------------|-------------------------------|---------------------|
| IN | 1110 0010 1010 1101 | OUT value before first shift: | 1110 0010 1010 1101 |
| | | After first shift left: | 1100 0101 0101 1010 |
| | | After second shift left: | 1000 1010 1011 0100 |
| | | After third shift left: | 0001 0101 0110 1000 |

7.10.2 ROR (Rotate right) and ROL (Rotate left) instructions

Table 7- 146 ROR and ROL instructions

| LAD / FBD | SCL | Description |
|-----------|--|---|
| | <pre> out := ROL(in:=_variant_in_, n:=_uint_in_); out := ROR(in:=_variant_in_, n:=_uint_in_); </pre> | <p>Use the rotate instructions (ROR and ROL) to rotate the bit pattern of parameter IN. The result is assigned to parameter OUT. Parameter N defines the number of bit positions rotated.</p> <ul style="list-style-type: none"> • ROR: Rotate bit pattern right • ROL: Rotate bit pattern left |

1 For LAD and FBD: Click the "???" and select the data types from the drop-down menu.

Table 7- 147 Data types for the parameters

| Parameter | Data type | Description |
|-----------|-------------------|------------------------------------|
| IN | Byte, Word, DWord | Bit pattern to rotate |
| N | UInt | Number of bit positions to rotate |
| OUT | Byte, Word, DWord | Bit pattern after rotate operation |

- For N=0, no rotate occurs. The IN value is assigned to OUT.
- Bit data rotated out one side of the target value is rotated into the other side of the target value, so no original bit values are lost.
- If the number of bit positions to rotate (N) exceeds the number of bits in the target value (8 for Byte, 16 for Word, 32 for DWord), then the rotation is still performed.
- ENO is always TRUE following execution of the rotate instructions.

Table 7- 148 ROR example for Word data

| Rotate bits out the right -side into the left -side (N = 1) | | | |
|---|---------------------|--------------------------------|---------------------|
| IN | 0100 0000 0000 0001 | OUT value before first rotate: | 0100 0000 0000 0001 |
| | | After first rotate right: | 1010 0000 0000 0000 |
| | | After second rotate right: | 0101 0000 0000 0000 |

Extended instructions

8.1 Date, time-of-day, and clock functions

8.1.1 Date and time-of-day instructions

Use the date and time instructions for calendar and time calculations.

- T_CONV converts a value to or from (date and time data types) and (byte, word, and dword size data types)
- T_ADD adds Time and DTL values: (Time + Time = Time) or (DTL + Time = DTL)
- T_SUB subtracts Time and DTL values: (Time - Time = Time) or (DTL - Time = DTL)
- T_DIFF provides the difference between two DTL values as a Time value: DTL - DTL = Time
- T_COMBINE combines a Date value and a Time_and_Date value to create a DTL value

For information about the format of DTL and Time data, refer to the section on the Time and Date data types (Page 113).

Table 8- 1 T_CONV (Convert times and extract) instruction

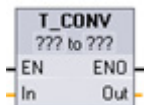
| LAD / FBD | SCL example | Description |
|---|---|--|
|  | <pre>out := DINT_TO_TIME (in:= _variant_in); out := TIME_TO_DINT (in:= _variant_in);</pre> | T_CONV converts a value to or from (date and time data types) and (byte, word, and dword size data types). |

- 1 For LAD and FBD boxes: Click "???" and select the source/target data types from the drop-down menu.
- 2 For SCL: Drag T_CONV from instruction tree and drop into the program editor, then select the source/target data types.

Table 8- 2 Valid data types for T_CONV conversions

| Data type IN (or OUT) | Data types OUT (or IN) |
|---|---|
| TIME (milliseconds) | DInt, Int, SInt, UDInt, UInt, USInt, TOD SCL only: Byte, Word, Dword |
| DATE (number of days since Jan. 1 1990) | DInt, Int, SInt, UDInt, UInt, USInt, DTL SCL only: Byte, Word, Dword |
| TOD (milliseconds since midnight- 24:00:00.000) | DInt, Int, SInt, UDInt, UInt, USInt, TIME, DTL SCL only: Byte, Word, Dword |

Note

Using T_CONV to convert a larger data size to a smaller data size

Data values can be truncated when you convert a larger data type with more bytes to a smaller data type with less bytes. If this error occurs, then ENO is set to 0.

Conversion to/from DTL data type

DTL (Date and Time Long) contains year, month, date, and time data. DTL data can be converted to/from DATE and TOD data types.

However, DTL conversion with DATE data only affects the year, month, and day values. DTL conversion with TOD data only affects the hour, minutes, and seconds values.

When T_CONV converts to DTL, the unaffected data elements in the DTL format are left unchanged.

Table 8-3 T_ADD (Add times) and T_SUB (Subtract times) instructions

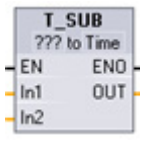
| LAD / FBD | SCL | Description |
|---|--|--|
|  | <pre>out := T_ADD(in1:=_variant_in, in2:=_time_in);</pre> | <p>T_ADD adds the input IN1 value (DTL or Time data types) with the input IN2 Time value. Parameter OUT provides the DTL or Time value result. Two data type operations are possible:</p> <ul style="list-style-type: none"> • Time + Time = Time • DTL + Time = DTL |
|  | <pre>out := T_SUB(in1:=_variant_in, in2:=_time_in);</pre> | <p>T_SUB subtracts the IN2 Time value from IN1 (DTL or Time value). Parameter OUT provides the difference value as a DTL or Time data type. Two data type operations are possible:</p> <ul style="list-style-type: none"> • Time - Time = Time • DTL - Time = DTL |

¹ For LAD and FBD: Click the "???" and select the data types from the drop-down menu.

Table 8-4 Data types for the T_ADD and T_SUB parameters

| Parameter and type | Data type | Description |
|--------------------|-----------|-------------|
| IN1 ¹ | IN | DTL, Time |
| IN2 | IN | Time |
| OUT | OUT | DTL, Time |

¹ Select the IN1 data type from the drop-down list available below the instruction name. The IN1 data type selection also sets the data type of parameter OUT.

Table 8-5 T_DIFF (Time difference) instruction

| LAD / FBD | SCL | Description |
|---|--|---|
|  | <pre>out := T_DIFF(in1:=_DTL_in, in2:=_DTL_in);</pre> | <p>T_DIFF subtracts the DTL value (IN2) from the DTL value (IN1). Parameter OUT provides the difference value as a Time data type.</p> <ul style="list-style-type: none"> DTL - DTL = Time |

Table 8-6 Data types for the T_DIFF parameters

| Parameter and type | Data type | Description |
|--------------------|-----------|-------------|
| IN1 | IN | DTL |
| IN2 | IN | DTL |
| OUT | OUT | Time |

Condition codes: ENO = 1 means no error occurred. ENO = 0 and parameter OUT = 0 errors:

- Invalid DTL value
- Invalid Time value

Table 8-7 T_COMBINE (Combine times) instruction

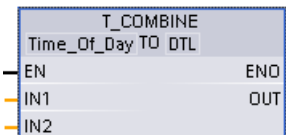
| LAD / FBD | SCL | Description |
|---|--|---|
|  | <pre>out := CONCAT_DATE_TOD(In1 := _date_in, In2 := _tod_in);</pre> | <p>T_COMBINE combines a Date value and a Time_of_Day value to create a DTL value.</p> |

¹ Note that the T_COMBINE instruction in the Extended Instructions equates to the CONCAT_DATE_TOD function in SCL.

Table 8-8 Data types for the T_COMBINE parameters

| Parameter and type | Data type | Description |
|--------------------|-----------|-------------|
| IN1 | IN | Date |
| IN2 | IN | Time_of_Day |
| OUT | OUT | DTL |

8.1.2 Clock functions

 **WARNING**

If an attacker can access your networks through Network Time Protocol (NTP) synchronization, the attacker can possibly take limited control of your process by shifting the CPU system time.

The NTP client feature of the S7-1200 CPU is disabled by default, and, when enabled, only allows configured IP addresses to act as an NTP server. The CPU disables this feature by default, and you must configure this feature to allow remotely-controlled CPU system time corrections.

The S7-1200 CPU supports "time of day" interrupts and clock instructions that depend upon accurate CPU system time. If you configure NTP and accept time synchronization from a server, you must ensure that the server is a trusted source. Failure to do so can cause a security breach that allows an unknown user to take limited control of your process by shifting the CPU system time.

For security information and recommendations, please see our "Operational Guidelines for Industrial Security" (http://www.industry.siemens.com/topics/global/en/industrial-security/Documents/operational_guidelines_industrial_security_en.pdf) on the Siemens Service and Support site.

Use the clock instructions to set and read the CPU system clock. The data type DTL (Page 113) is used to provide date and time values.

Table 8- 9 System time instructions

| LAD / FBD | SCL | Description |
|--|--|--|
|  | <pre>ret_val := WR_SYS_T(in:= DTL in);</pre> | WR_SYS_T (Set time-of-day) sets the CPU time of day clock with a DTL value at parameter IN. This time value does not include local time zone or daylight saving time offsets. |
|  | <pre>ret_val := RD_SYS_T(out=>_DTL_out);</pre> | RD_SYS_T (Read time-of-day) reads the current system time from the CPU. This time value does not include local time zone or daylight saving time offsets. |
|  | <pre>ret_val := RD_LOC_T(out=>_DTL_out);</pre> | RD_LOC_T (Read local time) provides the current local time of the CPU as a DTL data type. This time value reflects the local time zone adjusted appropriately for daylight saving time (if configured). |
|  | <pre>ret_val := WR_LOC_T(LOCTIME:=DTL_in_, DST: _in_;</pre> | WR_LOC_T (Write local time) sets the date and time of the CPU clock. You assign the date and time information as local time at LOCTIME with DTL data type. The instruction uses the "TimeTransformationRule (Page 289)" DB structure to calculate the system time. The granularity of the time information for local time and system time is product-specific and is at least one millisecond. Input values at the LOCTIME parameter which are less than those supported by the CPU are rounded up during system time calculation. Note: You must use the CPU device configuration to set the "Time of day" properties (time zone, DST activation, DST start, and DST stop). Otherwise, WR_LOC_T cannot interpret the DST time change. |

Table 8- 10 Data types for the parameters

| Parameter and type | Data type | Description |
|--------------------|-----------|---|
| IN | IN | DTL Time of day to set in the CPU system clock |
| OUT | OUT | DTL RD_SYS_T: Current CPU system time RD_LOC_T: Current local time, including any adjustment for daylight saving time, if configured |
| LOCTIME | IN | DTL WR_LOC_T: Local time |
| DST | IN | BOOL WR_LOC_T: Daylight Saving Time only evaluated during the "double hour" when the clocks change to daylight saving time. <ul style="list-style-type: none"> TRUE = daylight saving time (first hour) FALSE = standard time (second hour) |
| RET_VAL | OUT | Int Execution condition code |

8.1 Date, time-of-day, and clock functions

- The local time is calculated by using the time zone and daylight saving time offsets that you set in the device configuration general tab "Time of day" parameters.
- Time zone configuration is an offset to UTC or GMT time.
- Daylight saving time configuration specifies the month, week, day, and hour when daylight saving time begins.
- Standard time configuration also specifies the month, week, day, and hour when standard time begins.
- The time zone offset is always applied to the system time value. The daylight saving time offset is only applied when daylight saving time is in effect.

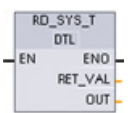
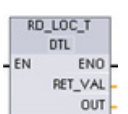
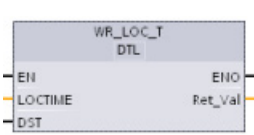
Note

Daylight saving and standard start time configuration

The "Time of day" properties for "Start for daylight saving time" of the CPU device configuration must be your local time.

Condition codes: ENO = 1 means no error occurred. ENO = 0 means an execution error occurred, and a condition code is provided at the RET_VAL output.

| RET_VAL (W#16#....) | Description |
|---------------------|--|
| 0000 | The current local time is in standard time. |
| 0001 | Daylight saving time has been configured, and the current local time is in daylight saving time. |
| 8080 | Local time not available or LOCTIME value is invalid. |
| 8081 | Illegal year value or time value assigned by the LOCTIME parameter is invalid |
| 8082 | Illegal month value (byte 2 in DTL format) |
| 8083 | Illegal day value (byte 3 in DTL format) |
| 8084 | Illegal hour value (byte 5 in DTL format) |
| 8085 | Illegal minute value (byte 6 in DTL format) |
| 8086 | Illegal second value (byte 7 in DTL format) |
| 8087 | Illegal nanosecond value (bytes 8 to 11 in DTL format) |
| 8089 | Time value does not exist (hour already passed upon changeover to daylight saving time) |
| 80B0 | The real-time clock has failed |
| 80B1 | The "TimeTransformationRule" structure has not been defined. |

8.1.3 TimeTransformationRule data structure

Description

The changeover rules for standard and daylight saving time are defined in the TimeTransformationRule structure. The structure is as follows:

| Name | Data type | Description |
|------------------------|------------|---|
| TimeTransformationRule | STRUCT | |
| Bias | INT | Time difference between local time and UTC [minutes] |
| DaylightBias | INT | Time difference between daylight saving and standard time [minutes] |
| DaylightStartMonth | USINT | Month of conversion to daylight saving time |
| DaylightStartWeek | USINT | Week of conversion to daylight saving time 1 = First occurrence of the weekday in the month, ..., 5 = Last occurrence of the weekday in the month |
| DaylightStartWeekday | USINT | Weekday of daylight saving time changeover: 1 = Sunday |
| DaylightStartHour | USINT | Hour of daylight saving time changeover |
| DaylightStartMinute | USINT | Minute of daylight saving time changeover |
| StandardStartMonth | USINT | Month of conversion to standard time |
| StandardStartWeek | USINT | Week of conversion to standard time 1 = First occurrence of the weekday in the month, ..., 5 = Last occurrence of the weekday in the month |
| StandardStartWeekday | USINT | Weekday of standard time changeover: 1 = Sunday |
| StandardStartHour | USINT | Hour of standard time changeover |
| StandardStartMinute | USINT | Minute of standard time changeover |
| TimeZoneName | STRING[80] | Name of time zone: "(GMT+01:00) Amsterdam, Berlin, Bern, Rome, Stockholm, Vienna" |

8.1.4 SET_TIMEZONE (Set timezone) instruction

Table 8- 11 SET_TIMEZONE instruction

| LAD / FBD | SCL | Description |
|-----------|---|---|
| | <pre>"SET_TIMEZONE_DB" (REQ:=_bool_in, Timezone:=_struct_in, DONE=>_bool_out_, BUSY=>_bool_out_, ERROR=>_bool_out_, STATUS=>_word_out_);</pre> | Sets the local time zone and daylight saving parameters that are used to transform the CPU system time to local time. |

¹ In the SCL example, "SET_TIMEZONE_DB" is the name of the instance DB.

Table 8- 12 Data types for the parameters

| Parameter and type | Data type | Description |
|--------------------|------------------------|---|
| REQ IN | Bool | REQ=1: execute function |
| Timezone IN | TimeTransformationRule | Rules for the transformation from system time to local time |
| DONE OUT | Bool | Function complete |
| BUSY OUT | Bool | Function busy |
| ERROR OUT | Bool | Error detected |
| STATUS OUT | Word | Function result / error message |

To manually configure the time zone parameters for the CPU, use the "Time of day" properties of the "General" tab of the device configuration.

Use the SET_TIMEZONE instruction to set the local time configuration programmatically. The parameters of the "TimeTransformationRule (Page 289)" structure assign the local time zone and timing for automatic switching between standard time and daylight saving time.

Condition codes: ENO = 1 means no error occurred. ENO = 0 means an execution error occurred, and a condition code is provided at the STATUS output.

| STATUS (W#16#....) | Description |
|--------------------|--|
| 0 | No error |
| 7000 | No job processing active |
| 7001 | Start of job processing. Parameter BUSY = 1, DONE = 0 |
| 7002 | Intermediate call (REQ irrelevant): Instruction already active; BUSY has the value "1". |
| 808x | Error at x-th component: For example 8084 indicates that DaylightStartWeekif is not a value from 1 to 5. |

8.1.5 RTM (Runtime meters) instruction

Table 8- 13 RTM instruction

| LAD / FBD | SCL | Description |
|---|--|---|
|  | <pre>RTM(NR:=_uint_in_, MODE:=_byte_in_, PV:=_dint_in_, CQ=>_bool_out_, CV=>_dint_out_);</pre> | The RTM (Runtime Meters) instruction can set, start, stop, and read the runtime hour meters in the CPU. |

Table 8- 14 Data types for the parameters

| Parameter and type | | Data type | Description |
|--------------------|-----|-----------|--|
| NR | IN | UInt | Runtime meter number: (possible values: 0..9) |
| MODE | IN | Byte | RTM Execution mode number: <ul style="list-style-type: none"> 0 = Fetch values (the status is then written to CQ and the current value to CV) 1 = Start (at the last counter value) 2 = Stop 4 = Set (to the value specified in PV) 5 = Set (to the value specified in PV) and then start 6 = Set (to the value specified in PV) and then stop 7 = Save all RTM values in the CPU to the MC (Memory Card) |
| PV | IN | DInt | Preset hours value for the specified runtime meter |
| RET_VAL | OUT | Int | Function result / error message |
| CQ | OUT | Bool | Runtime meter status (1 = running) |
| CV | OUT | DInt | Current runtime hours value for the specified meter |

The CPU operates up to 10 runtime hour meters to track the runtime hours of critical control subsystems. You must start the individual hour meters with one RTM execution for each timer. All runtime hour meters are stopped when the CPU makes a run-to-stop transition. You can also stop individual timers with RTM execution mode 2.

When a CPU makes a stop-to-run transition, you must restart the hour timers with one RTM execution for each timer that is started. After a runtime meter value is greater than 2147483647 hours, counting stops and the "Overflow" error is sent. You must execute the RTM instruction once for each timer to reset or modify the timer.

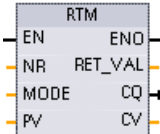
A CPU power failure or power cycle causes a power-down process that saves the current runtime meter values in retentive memory. Upon CPU power-up, the stored runtime meter values are reloaded to the timers and the previous runtime hour totals are not lost. The runtime meters must be restarted to accumulate additional runtime.

8.2 String and character

Your program can also use RTM execution mode 7 to save the runtime meter values in a memory card. The states of all timers at the instant RTM mode 7 is executed are stored in the memory card. These stored values can become incorrect over time as the hour timers are started and stopped during a program run session. You must periodically update the memory card values to capture important runtime events. The advantage that you get from storing the RTM values in the memory card is that you can insert the memory card in a substitute CPU where your program and saved RTM values will be available. If you did not save the RTM values in the memory card, then the timer values would be lost (in a substitute CPU).

Note

Avoid excessive program calls for memory card write operations

Minimize flash memory card write operations to extend the life of the memory card.

Table 8- 15 Condition codes

| RET_VAL (W#16#....) | Description |
|---------------------|--|
| 0 | No error |
| 8080 | Incorrect runtime meter number |
| 8081 | A negative value was passed to the parameter PV |
| 8082 | Overflow of the operating hours counter |
| 8091 | The input parameter MODE contains an illegal value |
| 80B1 | Value cannot be saved to MC (MODE=7) |

8.2 String and character

8.2.1 String data overview

String data type

String data is stored as a 2-byte header followed by up to 254 character bytes of ASCII character codes. A String header contains two lengths. The first byte is the maximum length that is given in square brackets when you initialize a string, or 254 by default. The second header byte is the current length that is the number of valid characters in the string. The current length must be smaller than or equal to the maximum length. The number of stored bytes occupied by the String format is 2 bytes greater than the maximum length.

Initialize your String data

String input and output data must be initialized as valid strings in memory, before execution of any string instructions.

Valid String data

A valid string has a maximum length that must be greater than zero but less than 255. The current length must be less than or equal to the maximum length.

Strings cannot be assigned to I or Q memory areas.

For more information see: Format of the String data type (Page 114).

8.2.2 S_MOVE (Move character string) instruction

Table 8- 16 String move instruction

| LAD / FBD | SCL | Description |
|-----------|-------------------------|--|
| | <code>out := in;</code> | Copy the source IN string to the OUT location. S_MOVE execution does not affect the contents of the source string. |

Table 8- 17 Data types for the parameters

| Parameter | Data type | Description |
|-----------|-----------|----------------|
| IN | String | Source string |
| OUT | String | Target address |

If the actual length of the string at the input IN exceeds the maximum length of a string stored at output OUT, then the part of the IN string which can fit in the OUT string is copied.

8.2.3 String conversion instructions

8.2.3.1 S_CONV, STRG_VAL, and VAL_STRG (Convert to/from character string and number) instructions

You can convert number character strings to number values or number values to number character strings with these instructions:

- S_CONV converts (number string to a number value) or (number value to a number string)
- STRG_VAL converts a number string to a number value with format options
- VAL_STRG converts a number value to a number string with format options

S_CONV (convert character string)

Table 8- 18 String conversion instruction

| LAD / FBD | SCL | Description |
|-----------|---|--|
| | <pre>out := <Type>_TO_<Type>(in);</pre> | Converts a character string to the corresponding value, or a value to the corresponding character string. The S_CONV instruction has no output formatting options. This makes the S_CONV instruction simpler, but less flexible than the STRG_VAL and VAL_STRG instructions. |

- 1 For LAD / FBD: Click the "???" and select the data type from the drop-down list.
- 2 For SCL: Select S_CONV from the Extended Instructions, and answer the prompts for the data types for the conversion. STEP 7 then provides the appropriate conversion instruction.

Table 8- 19 Data types (string to value)

| Parameter and type | | Data type | Description |
|--------------------|-----|--|------------------------|
| IN | IN | String | Input character string |
| OUT | OUT | String, Char, SInt, Int, DInt, USInt, UInt, UDInt, Real, LReal | Output number value |

Conversion of the string parameter IN starts at the first character and continues until the end of the string, or until the first character is encountered that is not "0" through "9", "+", "-", or ".". The result value is provided at the location specified in parameter OUT. If the output number value does not fit in the range of the OUT data type, then parameter OUT is set to 0 and ENO is set to FALSE. Otherwise, parameter OUT contains a valid result and ENO is set to TRUE.

Input String format rules:

- If a decimal point is used in the IN string, you must use the "." character.
- Comma characters "," used as a thousands separator to the left of the decimal point are allowed and ignored.
- Leading spaces are ignored.

S_CONV (value to string conversion)

Table 8- 20 Data types (value to string)

| Parameter and type | | Data type | Description |
|--------------------|-----|--|-------------------------|
| IN | IN | String, Char, SInt, Int, DInt, USInt, UInt, UDInt, Real, LReal | Input number value |
| OUT | OUT | String | Output character string |

An integer, unsigned integer, or floating point value IN is converted to the corresponding character string at OUT. The parameter OUT must reference a valid string before the conversion is executed. A valid string consists of a maximum string length in the first byte, the current string length in the second byte, and the current string characters in the next bytes. The converted string replaces characters in the OUT string starting at the first character and adjusts the current length byte of the OUT string. The maximum length byte of the OUT string is not changed.

How many characters are replaced depends on the parameter IN data type and number value. The number of characters replaced must fit within the parameter OUT string length. The maximum string length (first byte) of the OUT string should be greater than or equal to the maximum expected number of converted characters. The following table shows S_CONV value to string conversion examples.

Output String format rules:

- Values written to parameter OUT do not use a leading "+" sign.
- Fixed-point representation is used (no exponential notation).
- The period character "." is used to represent the decimal point when parameter IN is the Real data type.
- Values are right-justified in the output string and are preceded by space characters that fill empty character positions.

Table 8- 21 Maximum string lengths for each data type

| IN data type | Character positions allocated by S_CONV | Converted string example ¹ | Total string length including maximum and current length bytes |
|--------------|---|--|--|
| USInt | 4 | "x255" | 6 |
| SInt | 4 | "-128" | 6 |
| UInt | 6 | "x65535" | 8 |
| Int | 6 | "-32768" | 8 |
| UDInt | 11 | "x4294967295" | 13 |
| DInt | 11 | "-2147483648" | 13 |
| Real | 14 | "x-3.402823E+38" "x-1.175495E-38" "x+1.175495E-38" "x+3.402823E+38" | 16 |
| LReal | 21 | "-1.7976931348623E+308" "-2.2250738585072E-308" "+2.2250738585072E-308" "+1.7976931348623E+308" | 23 |

¹ The "x" characters represent space characters that fill empty positions in the right-justified field that is allocated for the converted value.

STRG_VAL (convert character string to numerical value)

Table 8- 22 String-to-value instruction

| LAD / FBD | SCL | Description |
|---|--|---|
|  | <pre>"STRG_VAL" (in:=_string_in, format:=_word_in, p:=uint_in, out=>_variant_out);</pre> | Converts a number character string to the corresponding integer or floating point representation. |

1 For LAD / FBD: Click the "???" and select the data type from the drop-down list.

Table 8- 23 Data types for the STRG_VAL instruction

| Parameter and type | | Data type | Description |
|--------------------|-----|--|--|
| IN | IN | String | The ASCII character string to convert |
| FORMAT | IN | Word | Output format options |
| P | IN | UInt, Byte, USInt | IN: Index to the first character to be converted (first character = 1) |
| OUT | OUT | SInt, Int, DInt, USInt, UInt, UDInt, Real, LReal | Converted number value |

Conversion begins in the string IN at character offset P and continues until the end of the string, or until the first character is encountered that is not "+", "-", ".", ";", "e", "E", or "0" to "9". The result is placed at the location specified in parameter OUT.

String data must be initialized before execution as a valid string in memory.

The FORMAT parameter for the STRG_VAL instruction is defined below. The unused bit positions must be set to zero.

Table 8- 24 Format of the STRG_VAL instruction

| Bit 16 | | | | | | | | Bit 8 | Bit 7 | | | | | | | Bit 0 | |
|--------|---|---|---|---|---|---|---|-------|-------|---|---|---|---|---|---|-------|---|
| 0 | 0 | 0 | 0 | 0 | 0 | 0 | 0 | 0 | 0 | 0 | 0 | 0 | 0 | 0 | 0 | f | r |

f = Notation format

1 = Exponential notation

0 = Fixed point notation

r = Decimal point format

1 = "," (comma character)

0 = "." (period character)

Table 8- 25 Values of the FORMAT parameter

| FORMAT (W#16#) | Notation format | Decimal point representation |
|----------------|-----------------|------------------------------|
| 0000 (default) | Fixed point | "." |
| 0001 | | " " |
| 0002 | Exponential | "." |
| 0003 | | " " |
| 0004 to FFFF | Illegal values | |

Rules for STRG_VAL conversion:

- If the period character "." is used for the decimal point, then commas "," to the left of the decimal point are interpreted as thousands separator characters. The comma characters are allowed and ignored.
- If the comma character "," is used for the decimal point, then periods "." to the left of the decimal point are interpreted as thousands separator characters. These period characters are allowed and ignored.
- Leading spaces are ignored.

VAL_STRG (convert numerical value to string)

Table 8- 26 Value-to-string operation

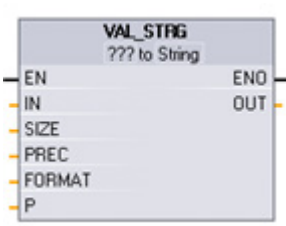
| LAD / FBD | SCL | Description |
|---|---|--|
|  | <pre>"VAL_STRG" (in:=_variant_in, size:=_usint_in, prec:=_usint_in, format:=_word_in, p:=_uint_in, out=>_string_out);</pre> | Converts an integer, unsigned integer, or floating point value to the corresponding character string representation. |

¹ For LAD / FBD: Click the "???" and select the data type from the drop-down list.

Table 8- 27 Data types for the VAL_STRG instruction

| Parameter and type | | Data type | Description |
|--------------------|-----|--|---|
| IN | IN | SInt, Int, DInt, USInt, UInt, UDInt, Real, LReal | Value to convert |
| SIZE | IN | USInt | Number of characters to be written to the OUT string |
| PREC | IN | USInt | The precision or size of the fractional portion. This does not include the decimal point. |
| FORMAT | IN | Word | Output format options |
| P | IN | UInt, Byte, USInt | IN: Index to the first OUT string character to be replaced (first character = 1) |
| OUT | OUT | String | The converted string |

Parameter OUT string format rules:

- Leading space characters are added to the leftmost part of the string when the converted string is smaller than the specified size.
- When the FORMAT parameter sign bit is FALSE, unsigned and signed integer data type values are written to the output buffer without the leading "+" sign. The "-" sign is used if required.
<leading spaces><digits without leading zeroes>'<PREC digits>
- When the sign bit is TRUE, unsigned and signed integer data type values are written to the output buffer always with a leading sign character.
<leading spaces><sign><digits without leading zeroes>'<PREC digits>
- When the FORMAT is set to exponential notation, Real data type values are written to the output buffer as:
<leading spaces><sign><digit> '.' <PREC digits>'E' <sign><digits without leading zero>
- When the FORMAT is set to fixed point notation, integer, unsigned integer, and real data type values are written to the output buffer as:
<leading spaces><sign><digits without leading zeroes>'<PREC digits>
- Leading zeros to the left of the decimal point (except the digit adjacent to the decimal point) are suppressed.
- Values to the right of the decimal point are rounded to fit in the number of digits to the right of the decimal point specified by the PREC parameter.
- The size of the output string must be a minimum of three bytes more than the number of digits to the right of the decimal point.
- Values are right-justified in the output string.

Conditions reported by ENO

When an error is encountered during the conversion operation, the following results will be returned:

- ENO is set to 0.
- OUT is set to 0, or as shown in the examples for string to value conversion.
- OUT is unchanged, or as shown in the examples when OUT is a string.

Table 8- 30 ENO status

| ENO | Description |
|-----|--|
| 1 | No error |
| 0 | Illegal or invalid parameter; for example, an access to a DB that does not exist |
| 0 | Illegal string where the maximum length of the string is 0 or 255 |
| 0 | Illegal string where the current length is greater than the maximum length |
| 0 | The converted number value is too large for the specified OUT data type. |
| 0 | The OUT parameter maximum string size must be large enough to accept the number of characters specified by parameter SIZE, starting at the character position parameter P. |

| ENO | Description |
|-----|--|
| 0 | Illegal P value where P=0 or P is greater than the current string length |
| 0 | Parameter SIZE must be greater than parameter PREC. |

Table 8- 31 Examples of S_CONV string to value conversion

| IN string | OUT data type | OUT value | ENO |
|---------------|---------------|-----------|-------|
| "123" | Int or DInt | 123 | TRUE |
| "-00456" | Int or DInt | -456 | TRUE |
| "123.45" | Int or DInt | 123 | TRUE |
| "+2345" | Int or DInt | 2345 | TRUE |
| "00123AB" | Int or DInt | 123 | TRUE |
| "123" | Real | 123.0 | TRUE |
| "123.45" | Real | 123.45 | TRUE |
| "1.23e-4" | Real | 1.23 | TRUE |
| "1.23E-4" | Real | 1.23 | TRUE |
| "12,345.67" | Real | 12345.67 | TRUE |
| "3.4e39" | Real | 3.4 | TRUE |
| "-3.4e39" | Real | -3.4 | TRUE |
| "1.17549e-38" | Real | 1.17549 | TRUE |
| "12345" | SInt | 0 | FALSE |
| "A123" | N/A | 0 | FALSE |
| "" | N/A | 0 | FALSE |
| "++123" | N/A | 0 | FALSE |
| "+-123" | N/A | 0 | FALSE |

Table 8- 32 Examples of S_CONV value to string conversion

| Data type | IN value | OUT string ¹ | ENO |
|-----------|------------------|-----------------------------|-------|
| UInt | 123 | "xxx123" | TRUE |
| UInt | 0 | "xxxxx0" | TRUE |
| UDInt | 12345678 | "xxx12345678" | TRUE |
| Real | +9123.456 | "xx+9.123456E+3" | TRUE |
| LReal | +9123.4567890123 | "xx+9.1234567890123 E+3" | TRUE |
| Real | -INF | "xxxxxxxxxxxINF" | FALSE |
| Real | +INF | "xxxxxxxxxxxINF" | FALSE |
| Real | NaN | "xxxxxxxxxxxNaN" | FALSE |

¹ The "x" characters represent space characters that fill empty positions in the right-justified field that is allocated for the converted value.

Table 8- 33 Examples of STRG_VAL conversion

| IN string | FORMAT (W#16#....) | OUT data type | OUT value | ENO |
|----------------------------------|-----------------------|---------------|-----------|-------|
| "123" | 0000 | Int or DInt | 123 | TRUE |
| "-00456" | 0000 | Int or DInt | -456 | TRUE |
| "123.45" | 0000 | Int or DInt | 123 | TRUE |
| "+2345" | 0000 | Int or DInt | 2345 | TRUE |
| "00123AB" | 0000 | Int or DInt | 123 | TRUE |
| "123" | 0000 | Real | 123.0 | TRUE |
| "-00456" | 0001 | Real | -456.0 | TRUE |
| "+00456" | 0001 | Real | 456.0 | TRUE |
| "123.45" | 0000 | Real | 123.45 | TRUE |
| "123.45" | 0001 | Real | 12345.0 | TRUE |
| "123.45" | 0000 | Real | 12345.0 | TRUE |
| "123.45" | 0001 | Real | 123.45 | TRUE |
| ".00123AB" | 0001 | Real | 123.0 | TRUE |
| "1.23e-4" | 0000 | Real | 1.23 | TRUE |
| "1.23E-4" | 0000 | Real | 1.23 | TRUE |
| "1.23E-4" | 0002 | Real | 1.23E-4 | TRUE |
| "12,345.67" | 0000 | Real | 12345.67 | TRUE |
| "12,345.67" | 0001 | Real | 12.345 | TRUE |
| "3.4e39" | 0002 | Real | +INF | TRUE |
| "-3.4e39" | 0002 | Real | -INF | TRUE |
| "1.1754943e-38" (and smaller) | 0002 | Real | 0.0 | TRUE |
| "12345" | N/A | SInt | 0 | FALSE |
| "A123" | N/A | N/A | 0 | FALSE |
| "" | N/A | N/A | 0 | FALSE |
| "++123" | N/A | N/A | 0 | FALSE |
| "+-123" | N/A | N/A | 0 | FALSE |

The following examples of VAL_STRG conversions are based on an OUT string initialized as follows:

"Current Temp = xxxxxxxxxxx C"

where the "x" character represents space characters allocated for the converted value.

Table 8- 34 Examples of VAL_STRG conversion

| Data type | IN value | P | SIZE | FORMAT (W#16#....) | PREC | OUT string | ENO |
|-----------|----------|----|------|--------------------|------|---------------------------------|-------|
| UInt | 123 | 16 | 10 | 0000 | 0 | Current Temp = xxxxxxxx123 C | TRUE |
| UInt | 0 | 16 | 10 | 0000 | 2 | Current Temp = xxxxxx0.00 C | TRUE |
| UDInt | 12345678 | 16 | 10 | 0000 | 3 | Current Temp = x12345.678 C | TRUE |
| UDInt | 12345678 | 16 | 10 | 0001 | 3 | Current Temp = x12345,678 C | TRUE |
| Int | 123 | 16 | 10 | 0004 | 0 | Current Temp = xxxxxx+123 C | TRUE |
| Int | -123 | 16 | 10 | 0004 | 0 | Current Temp = xxxxxx-123 C | TRUE |
| Real | -0.00123 | 16 | 10 | 0004 | 4 | Current Temp = xxx- 0.0012 C | TRUE |
| Real | -0.00123 | 16 | 10 | 0006 | 4 | Current Temp = - 1.2300E-3 C | TRUE |
| Real | -INF | 16 | 10 | N/A | 4 | Current Temp = xxxxxx-INF C | FALSE |
| Real | +INF | 16 | 10 | N/A | 4 | Current Temp = xxxxxx+INF C | FALSE |
| Real | NaN | 16 | 10 | N/A | 4 | Current Temp = xxxxxxNaN C | FALSE |
| UDInt | 12345678 | 16 | 6 | N/A | 3 | Current Temp = xxxxxxxxxx C | FALSE |

8.2.3.2 Strg_TO_Chars and Chars_TO_Strg (Convert to/from character string and array of CHAR) instructions

Strg_TO_Chars copies an ASCII character string into an array of character bytes.

Chars_TO_Strg copies an array of ASCII character bytes into a character string.

Note

Only the zero based array types (Array [0..n] of Char) or (Array [0..n] of Byte) are allowed as the input parameter Chars for the Chars_TO_Strg instruction, or as the IN_OUT parameter Chars for the Strg_TO_Chars instruction.

Table 8- 35 Strg_TO_Chars instruction

| LAD / FBD | SCL | Description |
|-----------|---|---|
| | <pre>Strg_TO_Chars(Strg:=_string_in_, pChars:=_dint_in_, Cnt=>_uint_out_, Chars:=_variant_inout_);</pre> | <p>The complete input string Strg is copied to an array of characters at IN_OUT parameter Chars.</p> <p>The operation overwrites bytes starting at array element number specified by the pChars parameter.</p> <p>Strings of all supported max lengths (1..254) may be used.</p> <p>An end delimiter is not written; this is your responsibility.</p> <p>To set an end delimiter just after the last written array character, use the next array element number [pChars+Cnt].</p> |

Table 8- 36 Data types for the parameters (Strg_TO_Chars)

| Parameter and type | | Data type | Description |
|--------------------|--------|-----------|--|
| Strg | IN | String | Source string |
| pChars | IN | DInt | Array element number for the first string character written to the target array |
| Chars | IN_OUT | Variant | The Chars parameter is a pointer to a zero-based array [0..n] of characters copied from the input string. The array can be declared in a DB or as local variables in the block interface. Example: "DB1".MyArray points to MyArray [0..10] of Char element values in DB1. |
| Cnt | OUT | UInt | Count of characters copied |

Table 8- 37 Chars_TO_Strg instruction

| LAD / FBD | SCL | Description |
|--|---|---|
|  | <pre>Chars_TO_Strg(Chars:=_variant_in_, pChars:=_dint_in_, Cnt:=_uint_in_, Strg=>_string_out_);</pre> | <p>All or part of an array of characters is copied to a string.</p> <p>The output string must be declared before Chars_TO_Strg is executed. The string is then overwritten by the Chars_TO_Strg operation.</p> <p>Strings of all supported maximum lengths (1..254) may be used.</p> <p>The string maximum length value is not changed by Chars_TO_Strg operation. Copying from array to string stops when the maximum string length is reached.</p> <p>A nul character '\$00' or 16#00 value in the character array works as a delimiter and ends copying of characters into the string.</p> |

Table 8- 38 Data types for the parameters (Chars_TO_Strg)

| Parameter and type | | Data type | Description |
|--------------------|-----|-----------|---|
| Chars | IN | Variant | The Chars parameter is a pointer to zero based array [0..n] of characters to be converted into a string. The array can be declared in a DB or as local variables in the block interface. Example: "DB1".MyArray points to MyArray [0..10] of Char element values in DB1. |
| pChars | IN | Dint | Element number for the first character in the array to copy. Array element [0] is the default value. |
| Cnt | IN | UInt | Count of characters to copy: 0 means all |
| Strg | OUT | String | Target string |

Table 8- 39 ENO status

| ENO | Description |
|-----|--|
| 1 | No error |
| 0 | Chars_TO_Strg: Attempt to copy more character bytes to the output string than allowed by the maximum length byte in the string declaration |
| 0 | Chars_TO_Strg: The nul character (16#00) value was found in the input character byte array. |
| 0 | Strg_TO_Chars: Attempt to copy more character bytes to the output array than are allowed by the element number limit |

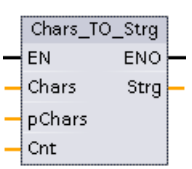
8.2.3.3 ATH and HTA (Convert to/from ASCII string and hexadecimal number) instructions

Use the ATH (ASCII to hexadecimal) and HTA (hexadecimal to ASCII) instructions for conversions between ASCII character bytes (characters 0 to 9 and uppercase A to F only) and the corresponding 4-bit hexadecimal nibbles.

Table 8- 40 ATH instruction

| LAD / FBD | SCL | Description |
|--|---|---|
|  | <pre>ret_val := ATH(in:=_variant_in_, n:=_int_in_, out=>_variant_out_);</pre> | Converts ASCII characters into packed hexadecimal digits. |

Table 8- 41 Data types for the ATH instruction

| Parameter type | | Data Type | Description |
|----------------|-----|-----------|---|
| IN | IN | Variant | Pointer to ASCII character byte array |
| N | IN | UInt | Number of ASCII character bytes to convert |
| RET_VAL | OUT | Word | Execution condition code |
| OUT | OUT | Variant | Pointer to the converted hexadecimal byte array |

Conversion begins at the location specified by parameter IN and continues for N bytes. The result is placed at the location specified by OUT. Only valid ASCII characters 0 to 9, lower case a to f, and uppercase A to F can be converted. Any other character will be converted to zero.

8-bit ASCII coded characters are converted to 4-bit hexadecimal nibbles. Two ASCII characters can be converted into a single byte containing two 4-bit hexadecimal nibbles.

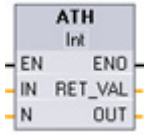
The IN and OUT parameters specify byte arrays and not hexadecimal String data. ASCII characters are converted and placed in the hexadecimal output in the same order as they are read. If there are an odd number of ASCII characters, then zeros are put in the right-most nibble of the last converted hexadecimal digit.

Table 8- 42 Examples of ASCII-to-hexadecimal (ATH) conversion

| IN character bytes | N | OUT value | ENO |
|--------------------|----|---------------|-------|
| '0a23' | 4 | W#16#0A23 | TRUE |
| '123AFx1a23' | 10 | 16#123AF01023 | FALSE |
| 'a23' | 3 | W#16#A230 | TRUE |

Table 8- 43 HTA instruction

| LAD / FBD | SCL | Description |
|---|--|--|
|  | <pre>ret_val := HTA(in:=_variant_in_, n:=_uint_in_, out=>_variant_out_);</pre> | Converts packed hexadecimal digits to their corresponding ASCII character bytes. |

Table 8- 44 Data types for the HTA instruction

| Parameter and type | Data Type | Description |
|--------------------|-----------|-------------|
| IN | IN | Variant |
| N | IN | UInt |
| RET_VAL | OUT | Word |
| OUT | OUT | Variant |

Conversion begins at the location specified by parameter IN and continues for N bytes. Each 4-bit nibble converts to a single 8-bit ASCII character and produces 2N ASCII character bytes of output. All 2N bytes of the output are written as ASCII characters 0 to 9 through uppercase A to F. The parameter OUT specifies a byte array and not a string.

Each nibble of the hexadecimal byte is converted into a character in the same order as they are read in (left-most nibble of a hexadecimal digit is converted first, followed by the right-most nibble of that same byte).

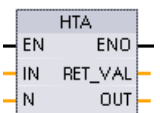
Table 8- 45 Examples of hexadecimal -to- ASCII (HTA) conversion

| IN value | N | OUT character bytes | ENO (ENO always TRUE after HTA execution) |
|----------------|---|---------------------|---|
| W#16#0123 | 2 | '0123' | TRUE |
| DW#16#123AF012 | 4 | '123AF012' | TRUE |

Table 8- 46 ATH and HTA condition codes

| RET_VAL (W#16#...) | Description | ENO |
|--------------------|---|-------|
| 0000 | No error | TRUE |
| 0007 | Invalid ATH input character: A character was found that was not an ASCII character 0-9, lowercase a to f, or uppercase A to F | FALSE |

| RET_VAL (W#16#....) | Description | ENO |
|------------------------|--|-------|
| 8101 | Illegal or invalid input pointer, for example, an access to a DB that does not exist. | FALSE |
| 8120 | Input string is an invalid format, i.e., max= 0, max=255, current>max, or grant length in pointer < max | FALSE |
| 8182 | Input buffer is too small for N | FALSE |
| 8151 | Data type not allowed for input buffer | FALSE |
| 8301 | Illegal or invalid output pointer, for example, an access to a DB that does not exist. | FALSE |
| 8320 | Output string is an invalid format, i.e., max= 0, max=255, current>max, or grant length in pointer < max | FALSE |
| 8382 | Output buffer is too small for N | FALSE |
| 8351 | Data type not allowed for output buffer | FALSE |

8.2.4 String operation instructions

Your control program can use the following string and character instructions to create messages for operator display and process logs.

8.2.4.1 MAX_LEN (Maximum length of a character string) instruction

Table 8- 47 Maximum length instruction

| LAD / FBD | SCL | Description |
|-----------|----------------------------------|--|
| | <pre>out := MAX_LEN (in) ;</pre> | <p>MAX_LEN (Maximum length of string) provides the maximum length value assigned to string IN at output OUT. If errors occur during processing of the instruction, then an empty string length will be output.</p> <p>The STRING data type contains two lengths: the first byte gives the maximum length and the second byte gives the current length (this is the current number of valid characters).</p> <ul style="list-style-type: none"> The maximum length of the character string is assigned for each STRING definition in square brackets. The number of bytes occupied by a string is 2 bytes greater than the maximum length. The current length represents the number of the character places actually used. The current length must be less than or equal to the maximum length. <p>Use the MAX_LEN instruction to get the maximum length of the character string and the LEN instruction to get the current length of a string.</p> |

Table 8- 48 Data types for the parameters

| Parameter and type | Data type | Description |
|--------------------|-----------|--|
| IN | String | Input string |
| OUT | DInt | Maximum number of characters allowed for IN string |

8.2.4.2 LEN (Determine the length of a character string) instruction

Table 8- 49 Length instruction

| LAD / FBD | SCL | Description |
|---|----------------------------|--|
|  | <pre>out := LEN(in);</pre> | LEN (length) provides the current length of the string IN at output OUT. An empty string has a length of zero. |

Table 8- 50 Data types for the parameters

| Parameter and type | | Data type | Description |
|--------------------|-----|------------------------|---|
| IN | IN | String | Input string |
| OUT | OUT | Int, DInt, Real, LReal | Number of valid characters of IN string |

Table 8- 51 ENO status

| ENO | Condition | OUT |
|-----|---|----------------------------|
| 1 | No invalid string condition | Valid string length |
| 0 | Current length of IN exceeds maximum length of IN | Current length is set to 0 |
| | Maximum length of IN does not fit within allocated memory range | |
| | Maximum length of IN is 255 (illegal length) | |

8.2.4.3 CONCAT (Combine character strings) instruction

Table 8- 52 Concatenate strings instruction

| LAD / FBD | SCL | Description |
|---|-------------------------------------|--|
|  | <pre>out := CONCAT(in1, in2);</pre> | CONCAT (concatenate strings) joins string parameters IN1 and IN2 to form one string provided at OUT. After concatenation, String IN1 is the left part and String IN2 is the right part of the combined string. |

Table 8- 53 Data types for the parameters

| Parameter and type | | Data type | Description |
|--------------------|-----|-----------|---------------------------------------|
| IN1 | IN | String | Input string 1 |
| IN2 | IN | String | Input string 2 |
| OUT | OUT | String | Combined string (string 1 + string 2) |

8.2 String and character

Table 8- 54 ENO status

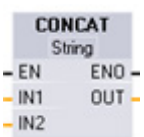
| ENO | Condition | OUT |
|-----|---|---|
| 1 | No errors detected | Valid characters |
| 0 | Resulting string after concatenation is larger than maximum length of OUT string | Resulting string characters are copied until the maximum length of the OUT is reached |
| | Current length of IN1 exceeds maximum length of IN1, current length of IN2 exceeds maximum length of IN2, or current length of OUT exceeds maximum length of OUT (invalid string) | Current length is set to 0 |
| | Maximum length of IN1, IN2 or OUT does not fit within allocated memory range | |
| | Maximum length of IN1 or IN2 is 255, or the maximum length of OUT is 0 or 255 | |

8.2.4.4 LEFT, RIGHT, and MID (Read substrings in a character string) instructions

Table 8- 55 Left, right and middle substring operations

| LAD / FBD | SCL | Description |
|-----------|----------------------------------|---|
| | <pre>out := LEFT(in, L);</pre> | <p>LEFT (Left substring) provides a substring made of the first L characters of string parameter IN.</p> <ul style="list-style-type: none"> If L is greater than the current length of the IN string, then the entire IN string is returned in OUT. If an empty string is the input, then an empty string is returned in OUT. |
| | <pre>out := MID(in, L, p);</pre> | <p>MID (Middle substring) provides the middle part of a string. The middle substring is L characters long and starts at character position P (inclusive).</p> <p>If the sum of L and P exceeds the current length of the string parameter IN, then a substring is returned that starts at character position P and continues to the end of the IN string.</p> |
| | <pre>out := RIGHT(in, L);</pre> | <p>RIGHT (Right substring) provides the last L characters of a string.</p> <ul style="list-style-type: none"> If L is greater than the current length of the IN string, then the entire IN string is returned in parameter OUT. If an empty string is the input, then an empty string is returned in OUT. |

Table 8- 56 Data types for the parameters

| Parameter and type | | Data type | Description |
|--------------------|-----|-----------|--|
| IN | IN | String | Input string |
| L | IN | Int | Length of the substring to be created: <ul style="list-style-type: none"> • LEFT uses the left-most characters number of characters in the string • RIGHT uses the right-most number of characters in the string • MID uses the number of characters starting at position P within the string |
| P | IN | Int | MID only: Position of first substring character to be copied P= 1, for the initial character position of the IN string |
| OUT | OUT | String | Output string |

Table 8- 57 ENO status

| ENO | Condition | OUT |
|-----|---|--|
| 1 | No errors detected | Valid characters |
| 0 | <ul style="list-style-type: none"> • L or P is less than or equal to 0 • P is greater than maximum length of IN • Current length of IN exceeds maximum length of IN, or current length of OUT exceeds maximum length of OUT • Maximum length of IN or OUT does not fit within allocated memory • Maximum length of IN or OUT is 0 or 255 | Current length is set to 0 |
| | Substring length (L) to be copied is larger than maximum length of OUT string. | Characters are copied until the maximum length of OUT is reached |
| | MID only: L or P is less than or equal to 0 | Current length is set to 0 |
| | MID only: P is greater than maximum length of IN | |
| | Current length of IN1 exceeds maximum length of IN1, or current length of IN2 exceeds maximum length of IN2 (invalid string) | Current length is set to 0 |
| | Maximum length of IN1, IN2 or OUT does not fit within allocated memory range | |
| | Maximum length of IN1, IN2 or OUT is 0 or 255 (illegal length) | |

8.2.4.5 DELETE (Delete characters in a character string) instruction

Table 8- 58 Delete substring instruction

| LAD / FBD | SCL | Description |
|---|-------------------------------------|---|
|  | <pre>out := DELETE(in, L, p);</pre> | <p>Deletes L characters from string IN. Character deletion starts at character position P (inclusive), and the remaining substring is provided at parameter OUT.</p> <ul style="list-style-type: none"> • If L is equal to zero, then the input string is returned in OUT. • If the sum of L and P is greater than the length of the input string, then the string is deleted to the end. |

Table 8- 59 Data types for the parameters

| Parameter and type | Data type | Description |
|--------------------|-----------|--|
| IN | String | Input string |
| L | Int | Number of characters to be deleted |
| P | Int | Position of the first character to be deleted: The first character of the IN string is position number 1 |
| OUT | String | Output string |

Table 8- 60 ENO status

| ENO | Condition | OUT |
|-----|---|---|
| 1 | No errors detected | Valid characters |
| 0 | P is greater than current length of IN | IN is copied to OUT with no characters deleted |
| | Resulting string after characters are deleted is larger than maximum length of OUT string | Resulting string characters are copied until the maximum length of OUT is reached |
| | L is less than 0, or P is less than or equal to 0 | Current length is set to 0 |
| | Current length of IN exceeds maximum length of IN, or current length of OUT exceeds maximum length of OUT | |
| | Maximum length of IN or OUT does not fit within allocated memory | |
| | Maximum length of IN or OUT is 0 or 255 | |

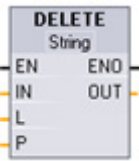
8.2.4.6 INSERT (Insert characters in a character string) instruction

Table 8- 61 Insert substring instruction

| LAD / FBD | SCL | Description |
|-----------|--|---|
| | <pre>out := INSERT(in1, in2, p);</pre> | Inserts string IN2 into string IN1. Insertion begins after the character at position P. |

Table 8- 62 Data types for the parameters

| Parameter and type | Data type | Description |
|--------------------|-----------|-------------|
| IN1 | IN | String |
| IN2 | IN | String |
| P | IN | Int |
| OUT | OUT | String |

Table 8- 63 ENO status

| ENO | Condition | OUT |
|-----|---|---|
| 1 | No errors detected | Valid characters |
| 0 | P is greater than length of IN1 | IN2 is concatenated with IN1 immediately following the last IN1 character |
| | P is less than 0 | Current length is set to 0 |
| | Resulting string after insertion is larger than maximum length of OUT string | Resulting string characters are copied until the maximum length of OUT is reached |
| | Current length of IN1 exceeds maximum length of IN1, current length of IN2 exceeds maximum length of IN2, or current length of OUT exceeds maximum length of OUT (invalid string) | Current length is set to 0 |
| | Maximum length of IN1, IN2 or OUT does not fit within allocated memory range | |
| | Maximum length of IN1 or IN2 is 255, or maximum length of OUT is 0 or 255 | |

8.2.4.7 REPLACE (Replace characters in a character string) instruction

Table 8- 64 Replace substring instruction

| LAD / FBD | SCL | Description |
|-----------|--|---|
| | <pre> out := REPLACE (in1:=_string_in_, in2:=_string_in_, L:=_int_in_, p:=_int_in_); </pre> | Replaces L characters in the string parameter IN1. Replacement starts at string IN1 character position P (inclusive), with replacement characters coming from the string parameter IN2. |

Table 8- 65 Data types for the parameters

| Parameter and type | Data type | Description |
|--------------------|-----------|-------------|
| IN1 | IN | String |
| IN2 | IN | String |
| L | IN | Int |
| P | IN | Int |
| OUT | OUT | String |

If parameter L is equal to zero, then the string IN2 is inserted at position P of string IN1 without deleting any characters from string IN1.

If P is equal to one, then the first L characters of string IN1 are replaced with string IN2 characters.

Table 8- 66 ENO status

| ENO | Condition | OUT |
|---|--|---|
| 1 | No errors detected | Valid characters |
| 0 | P is greater than length of IN1 | IN2 is concatenated with IN1 immediately following the last IN1 character |
| | P points within IN1, but fewer than L characters remain in IN1 | IN2 replaces the end characters of IN1 beginning at position P |
| | Resulting string after replacement is larger than maximum length of OUT string | Resulting string characters are copied until the maximum length of OUT is reached |
| | Maximum length of IN1 is 0 | IN2 characters are copied to OUT |
| | L is less than 0, or P is less than or equal to 0 | Current length is set to 0 |
| | Current length of IN1 exceeds maximum length of IN1, current length of IN2 exceeds maximum length of IN2, or current length of OUT exceeds maximum length of OUT | |
| | Maximum length of IN1, IN2 or OUT does not fit within allocated memory range | |
| Maximum length of IN1 or IN2 is 255, or maximum length of OUT is 0 or 255 | | |

8.2.4.8 FIND (Find characters in a character string) instruction

Table 8- 67 Find substring instruction

| LAD / FBD | SCL | Description |
|---|---|--|
|  | <pre>out := FIND(in1:=_string_in_, in2:=_string_in);</pre> | <p>Provides the character position of the substring specified by IN2 within the string IN1. The search starts on the left. The character position of the first occurrence of IN2 string is returned at OUT. If the string IN2 is not found in the string IN1, then zero is returned.</p> |

Table 8- 68 Data types for the parameters

| Parameter and type | Data type | Description |
|--------------------|-----------|-------------|
| IN1 | IN | String |
| IN2 | IN | String |
| OUT | OUT | Int |

Table 8- 69 ENO status

| ENO | Condition | OUT |
|-----|--|--------------------------------|
| 1 | No errors detected | Valid character position |
| 0 | IN2 is larger than IN1 | Character position is set to 0 |
| | Current length of IN1 exceeds maximum length of IN1, or current length of IN2 exceeds maximum length of IN2 (invalid string) | |
| | Maximum length of IN1 or IN2 does not fit within allocated memory range | |
| | Maximum length of IN1 or IN2 is 255 | |

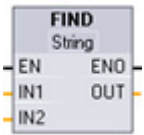
8.3 Distributed I/O (PROFINET, PROFIBUS, or AS-i)

8.3.1 Distributed I/O Instructions

The following Distributed I/O instructions can be used with PROFINET, PROFIBUS, or AS-i:

- RDREC instruction (Page 315): You can read a data record with the number INDEX from a module or device.
- WRREC instruction (Page 315): You can transfer a data record with the number INDEX to a module or device defined by ID.
- RALRM instruction (Page 318): You can receive an interrupt with all corresponding information from a module or device and supply this information to its output parameters.
- DPRD_DAT instruction (Page 326): You must read consistent data areas greater than 64 bytes from a module or device with the DPRD_DAT instruction.
- DPWR_DAT instruction (Page 326): You must write consistent data areas greater than 64 bytes to a module or device with the DPWR_DAT instruction.

The DPNRM_DG instruction (Page 328) can only be used with PROFIBUS. You can read the current diagnostic data of a DP slave in the format specified by EN 50 170 Volume 2, PROFIBUS.

8.3.2 RDREC and WRREC (Read/write data record) instructions

You can use the RDREC (Read data record) and WRREC (Write data record) instructions with PROFINET, PROFIBUS, and AS-i.

Table 8- 70 RDREC and WRREC instructions

| LAD / FBD | SCL | Description |
|-------------------|---|--|
| <p>"RDREC_DB"</p> | <pre>"RDREC_DB" (req:=_bool_in_, ID:=_word_in_, index:=_dint_in_, mlen:=_uint_in_, valid=>_bool_out_, busy=>_bool_out_, error=>_bool_out_, status=>_dword_out_, len=>_uint_out_, record:=_variant_inout_);</pre> | <p>Use the RDREC instruction to read a data record with the number INDEX from the component addressed by the ID, such as a central rack or a distributed component (PROFIBUS DP or PROFINET IO). Assign the maximum number of bytes to read in MLEN. The selected length of the target area RECORD should have at least the length of MLEN bytes.</p> |
| <p>"WRREC_DB"</p> | <pre>"WRREC_DB" (req:=_bool_in_, ID:=_word_in_, index:=_dint_in_, len:=_uint_in_, done=>_bool_out_, busy=>_bool_out_, error=>_bool_out_, status=>_dword_out_, record:=_variant_inout_);</pre> | <p>Use the WRREC instruction to transfer a data RECORD with the record number INDEX to a DP slave/PROFINET IO device component addressed by ID, such as a module in the central rack or a distributed component (PROFIBUS DP or PROFINET IO). Assign the byte length of the data record to be transmitted. The selected length of the source area RECORD should, therefore, have at least the length of LEN bytes.</p> |

- STEP 7 automatically creates the DB when you insert the instruction.
- In the SCL examples, "RDREC_DB" and "WRREC_DB" are the names of the instance DBs.

Table 8- 71 RDREC and WRREC data types for the parameters

| Parameter and type | | Data type | Description |
|--------------------|-----|--|---|
| REQ | IN | Bool | REQ = 1: Transfer data record |
| ID | IN | HW_IO (Word) | <p>Logical address of the DP slave/PROFINET IO component (module or submodule):</p> <ul style="list-style-type: none"> For an output module, bit 15 must be set (for example, for address 5: ID:= DW#16#8005). For a combination module, the smaller of the two addresses should be specified. <p>Note: In V3.0, the device ID can be determined in one of two ways:</p> <ul style="list-style-type: none"> By making the following "Network view" selections: <ul style="list-style-type: none"> Device (gray box) "Properties" of the device "Hardware identifier" <p>Note: Not all devices display their Hardware identifiers, however.</p> By making the following "Project tree" menu selections: <ul style="list-style-type: none"> PLC tags Default tag table System constants tab <p>All configured device Hardware identifiers are displayed.</p> <p>Note: In V4.0, the device ID (hardware identifier) for the interface module is determined by going to the tag table and locating the "Device Name [HEAD]" parameter under System Constants.</p> |
| INDEX | IN | Byte, Word, USInt, UInt, SInt, Int, DInt | Data record number |
| MLEN | IN | Byte, USInt, UInt | Maximum length in bytes of the data record information to be fetched (RDREC) |
| VALID | OUT | Bool | New data record was received and valid (RDREC). The VALID bit is TRUE for one scan, after the last request was completed with no error. |
| DONE | OUT | Bool | Data record was transferred (WRREC). The DONE bit is TRUE for one scan, after the last request was completed with no error. |
| BUSY | OUT | Bool | <ul style="list-style-type: none"> BUSY = 1: The read (RDREC) or write (WRREC) process is not yet terminated. BUSY = 0: Data record transmission is completed. |
| ERROR | OUT | Bool | ERROR = 1: A read (RDREC) or write (WRREC) error has occurred. The ERROR bit is TRUE for one scan, after the last request was terminated with an error. The error code value at the STATUS parameter is valid only during the single scan where ERROR = TRUE. |
| STATUS | OUT | DWord | Block status or error information |

| Parameter and type | | Data type | Description |
|--------------------|---------------------------|-----------|---|
| LEN | OUT (RDREC) IN (WRREC) | UInt | <ul style="list-style-type: none"> Length of the fetched data record information (RDREC) Maximum byte length of the data record to be transferred (WRREC) |
| RECORD | IN_OUT | Variant | <ul style="list-style-type: none"> Target area for the fetched data record (RDREC) Data record (WRREC) |

The RDREC and WRREC instructions operate asynchronously, that is, processing covers multiple instruction calls. Start the job by calling RDREC or WRREC with REQ = 1.

The job status is displayed via output parameter BUSY and the two central bytes of output parameter STATUS. The transfer of the data record is complete when the output parameter BUSY has been set to FALSE

A value of TRUE (only for one scan) on the output parameter VALID (RDREC) or DONE (WRREC) verifies that the data record has been successfully transferred into the target area RECORD (RDREC) or to the target device (WRREC). In the case of the RDREC, the output parameter LEN contains the length of the fetched data in bytes.

The output parameter ERROR (only for one scan when ERROR = TRUE) indicates that a data record transmission error has occurred. In this case, the output parameter STATUS (only for the one scan when ERROR = TRUE) contains the error information.

Data records are defined by the hardware device manufacturer. Refer to the hardware manufacturer's device documentation for details about a data record.

Note

If a DPV1 slave is configured via GSD file (GSD rev. 3 and higher) and the DP interface of the DP master is set to "S7 compatible", then you may not read any data records from the I/O modules in the user program with "RDREC" or write to the I/O modules with "WRREC". In this case, the DP master addresses the wrong slot (configured slot + 3).

Remedy: set the interface of the DP master to "DPV1".

Note

The interfaces of the "RDREC" and "WRREC" instructions are identical to the "RDREC" and "WRREC" FBs defined in "PROFIBUS Guideline PROFIBUS Communication and Proxy Function Blocks according to IEC 61131-3".

Note

If you use "RDREC" or "WRREC" to read or write a data record for PROFINET IO, then negative values in the INDEX, MLEN, and LEN parameters will be interpreted as an unsigned 16-bit integer.

8.3.3 RALRM (Receive interrupt) instruction

You can use the RALRM (Read alarm) instruction with PROFINET and PROFIBUS.

Table 8- 72 RALRM instruction

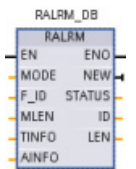
| LAD / FBD | SCL | Description |
|---|---|--|
|  | <pre>"RALRM_DB" (mode:=_int_in_, f_ID:=_word_in_, mlen:=_uint_in_, new=>_bool_out_, status=>_dword_out_, ID=>_word_out_, len=>_uint_out_, tinfo:=_variant_inout_, ainfo:=_variant_inout_);</pre> | <p>Use the RALRM (read alarm) instruction to read diagnostic interrupt information from PROFIBUS or PROFINET I/O modules/devices.</p> <p>The information in the output parameters contains the start information of the called OB as well as information of the interrupt source.</p> <p>Call RALRM in an interrupt OB to return information regarding the event(s) that caused the interrupt. In the S7-1200. The following Diagnostic OB interrupts are supported: Status, Update, Profile, Diagnostic error interrupt, Pull or plug of modules, Rack or station failure</p> |

- STEP 7 automatically creates the DB when you insert the instruction.
- In the SCL example, "RALRM_DB" is the name of the instance DB.

Table 8- 73 Data types for the parameters

| Parameter and type | | Data type | Description |
|--------------------|-----|------------------------|--|
| MODE | IN | Byte, USInt, SInt, Int | Operating mode |
| F_ID | IN | HW_IO (Word) | <p>Logical start address of the component (module) from which interrupts are to be received</p> <p>Note: The device ID can be determined in one of two ways:</p> <ul style="list-style-type: none"> By making the following "Network view" selections: <ul style="list-style-type: none"> Device (gray box) "Properties" of the device "Hardware identifier" Note: Not all devices display their Hardware identifiers. By making the following "Project tree" menu selections: <ul style="list-style-type: none"> PLC tags Default tag table System constants tab All configured device Hardware identifiers are displayed. |
| MLEN | IN | Byte, USInt, UInt | Maximum length in bytes of the data interrupt information to be received. MLEN of 0 will allow receipt of as much data interrupt information as is available in the AINFO Target Area. |
| NEW | OUT | Bool | A new interrupt was received. |
| STATUS | OUT | DWord | Status of the RALRM instruction. Refer to "STATUS parameter for RDREC, WRREC, and RALRM" (Page 322) for more information. |

| Parameter and type | | Data type | Description |
|--------------------|--------|--------------------------------------|--|
| ID | OUT | HW_IO (Word) | Hardware identifier of the I/O module that caused the diagnostic interrupt Note: Refer to the F_ID parameter for an explanation of how to determine the device ID. |
| LEN | OUT | DWord, UInt, UInt, DInt, Real, LReal | Length of the received AINFO interrupt information |
| TINFO | IN_OUT | VARIANT | Task information: Target range for OB start and management information. The TINFO length is always 32 bytes. |
| AINFO | IN_OUT | VARIANT | Interrupt information: Target area for header information and additional interrupt information. For AINFO, provide a length of at least the MLEN bytes, if MLEN is greater than 0. The AINFO length is variable. |

Note

If you call "RALRM" in an OB whose start event is not an I/O interrupt, the instruction will provide correspondingly reduced information in its outputs.

Make sure to use different instance DBs when you call "RALRM" in different OBs. If you evaluate data resulting from a "RALRM" call outside of the associated interrupt OB, you should use a separate instance DB per OB start event.

Note

The interface of the "RALRM" instruction is identical to the "RALRM" FB defined in "PROFIBUS Guideline PROFIBUS Communication and Proxy Function Blocks according to IEC 61131-3".

Calling RALRM

You can call the RALRM instruction in three different operating modes (MODE).

Table 8- 74 RALRM instruction operating modes

| MODE | Description |
|------|--|
| 0 | <ul style="list-style-type: none">• ID contains the hardware identifier of the I/O module that triggered the interrupt.• Output parameter NEW is set to TRUE.• LEN produces an output of 0.• AINFO and TINFO are not updated with any information. |
| 1 | <ul style="list-style-type: none">• ID contains the hardware identifier of the I/O module that triggered the interrupt.• Output parameter NEW is set to TRUE.• LEN produces an output of the amount in bytes of AINFO data that is returned.• AINFO and TINFO are updated with interrupt-related information. |
| 2 | <p>If the hardware identifier assigned to input parameter F_ID has triggered the interrupt then:</p> <ul style="list-style-type: none">• ID contains the hardware identifier of the I/O module that triggered the interrupt. Should be the same as the value at F_ID.• Output parameter NEW is set to TRUE.• LEN produces an output of the amount in bytes of AINFO data that is returned.• AINFO and TINFO are updated with interrupt-related information. |

Note

If you assign a destination area for TINFO or AINFO that is too short, RALRM cannot return the full information.

MLEN can limit the amount of AINFO data that is returned.

Refer to the AINFO parameters and TINFO parameters of the online information system of STEP 7 for information on how to interpret the TINFO and AINFO data.

TInfo organization block data

The table below shows how the TInfo data is arranged for the RALRM instruction:

| | | | | | |
|---|-----------------|--------------|----------|-------------|-----------|
| Same for OBs: Status, Update, Profile, Diagnostic error interrupt, Pull or plug of modules, Rack or station failure | 0 | SI_Format | OB_Class | OB_Nr | |
| | 4 | LADDR | | | |
| TI_Submodule - OBs: Status, Update, Profile | 4 | | | Slot | |
| | 8 | Specifier | | 0 | |
| TI_DiagnosticInterrupt - OB: Diagnostic error interrupt | 4 | | | IO_State | |
| | 8 | Channel | | MultiError | 0 |
| TI_PlugPullModule - OB: Pull or plug of modules | 4 | | | Event_Class | Fault_ID |
| | 8 | 0 | | 0 | |
| TI_StationFailure - OB: Rack or station failure | 4 | | | Event_Class | Fault_ID |
| | 8 | 0 | | 0 | |
| Same for OBs: Status, Update, Profile, Diagnostic error interrupt, Pull or plug of modules, Rack or station failure | 12 | 0 | | | |
| | 16 | | | | |
| | 20 | address | | slv_prfl | intr_type |
| | 24 | flags1 | flags2 | id | |
| | 28 ¹ | manufacturer | | instance | |

¹ Bytes 28 - 31 (manufacturer and instance) are not used with PROFIBUS.

Note

Refer to the online information system of STEP 7 for more detailed information on TINFO data.

8.3.4 STATUS parameter for RDREC, WRREC, and RALRM

The output parameter STATUS contains error information that is interpreted as ARRAY[1...4] OF BYTE, with the following structure:

Table 8- 75 STATUS output array

| Array element | Name | Description |
|---------------|--------------|--|
| STATUS[1] | Function_Num | <ul style="list-style-type: none"> B#16#00, if no error Function ID from DPV1-PDU: If an error occurs, B#16#80 is OR'ed (for read data record: B#16#DE; for write data record: B#16#DF). If no DPV1 protocol element is used, then B#16#C0 will be output. |
| STATUS[2] | Error Decode | Location of the error ID |
| STATUS[3] | Error_Code_1 | Error ID |
| STATUS[4] | Error_Code_2 | Manufacturer-specific error ID expansion |

Table 8- 76 STATUS[2] values

| Error_decode (B#16#...) | Source | Description |
|-------------------------|------------|--|
| 00 to 7F | CPU | No error or no warning |
| 80 | DPV1 | Error according to IEC 61158-6 |
| 81 to 8F | CPU | B#16#8x shows an error in the "xth" call parameter of the instruction. |
| FE, FF | DP Profile | Profile-specific error |

Table 8- 77 STATUS[3] values

| Error_decode (B#16#...) | Error_code_1 (B#16#...) | Explanation (DVP1) | Description |
|-------------------------|-------------------------|--------------------|--|
| 00 | 00 | | No error, no warning |
| 70 | 00 | Reserved, reject | Initial call; no active data record transfer |
| | 01 | Reserved, reject | Initial call; data record transfer has started |
| | 02 | Reserved, reject | Intermediate call; data record transfer already active |
| 80 | 90 | Reserved, pass | Invalid logical start address |
| | 92 | Reserved, pass | Illegal type for Variant pointer |
| | 93 | Reserved, pass | The DP component addressed via ID or F_ID is not configured. |

| Error_decode (B#16#....) | Error_code_1 (B#16#....) | Explanation (DVP1) | Description |
|-----------------------------|-----------------------------|-----------------------|--|
| | 96 | | The "RALRM (Page 318)" cannot supply the OB start information, management information, header information, or additional interrupt information. For the following OBs, you can use the "DPNRM_DG (Page 328)" instruction to read the current diagnostics message frame of the relevant DP slave asynchronously (address information from OB start information): <ul style="list-style-type: none"> • Hardware interrupt (Page 87) • Status (Page 93), Update (Page 93) or Profile (Page 94) • Diagnostic error interrupt (Page 89) • Pull or plug of modules (Page 91) |
| | A0 | Read error | Negative acknowledgement while reading from the module |
| | A1 | Write error | Negative acknowledgement while writing to the module |
| | A2 | Module failure | DP protocol error at layer 2 (for example, slave failure or bus problems) |
| | A3 | Reserved, pass | <ul style="list-style-type: none"> • PROFIBUS DP: DP protocol error with Direct-Data-Link-Mapper or User-Interface/User • PROFINET IO: General CM error |
| | A4 | Reserved, pass | Communication on the communication bus disrupted |
| | A5 | Reserved, pass | - |
| | A7 | Reserved, pass | DP slave or modules is occupied (temporary error). |
| | A8 | Version conflict | DP slave or module reports non-compatible versions. |
| | A9 | Feature not supported | Feature not supported by DP slave or module |
| | AA to AF | User specific | DP slave or module reports a manufacturer-specific error in its application. Please check the documentation from the manufacturer of the DP slave or module. |
| | B0 | Invalid index | Data record not known in module; illegal data record number ≥ 256 |
| | B1 | Write length error | The length information in the RECORD parameter is incorrect. <ul style="list-style-type: none"> • With "RALRM": Length error in AINFO <p>Note: Refer to the online information system of STEP 7 for immediate access to information on how to interpret the "AINFO" returned buffers.</p> <ul style="list-style-type: none"> • With "RDREC (Page 315)" and "WRREC (Page 315)": Length error in "MLEN" |
| | B2 | Invalid slot | The configured slot is not occupied. |
| | B3 | Type conflict | Actual module type does not match specified module type. |
| | B4 | Invalid area | DP slave or module reports access to an invalid area. |
| | B5 | Status conflict | DP slave or module not ready |
| | B6 | Access denied | DP slave or module denies access. |

| Error_decode (B#16#...) | Error_code_1 (B#16#...) | Explanation (DVP1) | Description |
|----------------------------|----------------------------|---------------------------|--|
| | B7 | Invalid range | DP slave or module reports an invalid range for a parameter or value. |
| | B8 | Invalid parameter | DP slave or module reports an invalid parameter. |
| | B9 | Invalid type | DP slave or module reports an invalid type: <ul style="list-style-type: none"> With "RDREC (Page 315)": Buffer too small (subsets cannot be read) With "WRREC (Page 315)": Buffer too small (subsets cannot be written) |
| | BA to BF | User specific | DP slave or module reports a manufacturer-specific error when accessing. Please check the documentation from the manufacturer of the DP slave or module. |
| | C0 | Read constraint conflict | <ul style="list-style-type: none"> With "WRREC (Page 315)": The data can only be written when the CPU is in STOP mode. Note: This means that data cannot be written by the user program. You can only write the data online with a PG/PC. With "RDREC (Page 315)": The module routes the data record, but either no data is present or the data can only be read when the CPU is in STOP mode. Note: If data can only be read when the CPU is in STOP mode, no evaluation by the user program is possible. In this case, you can only read the data online with a PG/PC. |
| | C1 | Write constraint conflict | The data of the previous write request to the module for the same data record has not yet been processed by the module. |
| | C2 | Resource busy | The module is currently processing the maximum possible number of jobs for a CPU. |
| | C3 | Resource unavailable | The required operating resources are currently occupied. |
| | C4 | | Internal temporary error. Job could not be carried out. Repeat the job. If this error occurs often, check your installation for sources of electrical interference. |
| | C5 | | DP slave or module not available |
| | C6 | | Data record transfer was cancelled due to priority class cancellation. |
| | C7 | | Job aborted due to warm or cold restart on the DP master. |
| | C8 to CF | | DP slave or module reports a manufacturer-specific resource error. Please check the documentation from the manufacturer of the DP slave or module. |
| | Dx | User specific | DP Slave specific. Refer to the description of the DP Slave. |
| 81 | 00 to FF | | Error in the initial call parameter (with "RALRM (Page 318)": MODE) |
| | 00 | | Illegal operating mode |
| 82 | 00 to FF | | Error in the second call parameter |

| Error_decode (B#16#....) | Error_code_1 (B#16#....) | Explanation (DVP1) | Description |
|-----------------------------|-----------------------------|--------------------|--|
| 88 | 00 to FF | | Error in the eighth call parameter (with "RALRM (Page 318)": TINFO) Note: Refer to the online information system of STEP 7 for immediate access to information on how to interpret the "TINFO" returned buffers. |
| | 01 | | Wrong syntax ID |
| | 23 | | Quantity structure exceeded or destination area too small |
| | 24 | | Wrong range ID |
| | 32 | | DB/DI number out of user range |
| | 3A | | DB/DI number is NULL for area ID DB/DI, or specified DB/DI does not exist. |
| 89 | 00 to FF | | Error in the ninth call parameter (with "RALRM (Page 318)": AINFO) Note: Refer to the online information system of STEP 7 for immediate access to information on how to interpret the "AINFO" returned buffers. |
| | 01 | | Wrong syntax ID |
| | 23 | | Quantity structure exceeded or destination area too small |
| | 24 | | Wrong range ID |
| | 32 | | DB/DI number out of user range |
| | 3A | | DB/DI number is NULL for area ID DB/DI, or specified DB/DI does not exist. |
| 8A | 00 to FF | | Error in the 10th call parameter |
| 8F | 00 to FF | | Error in the 15th call parameter |
| FE, FF | 00 to FF | | Profile-specific error |

Array element STATUS[4]

With DPV1 errors, the DP Master passes on STATUS[4] to the CPU and to the instruction. Without a DPV1 error, this value is set to 0, with the following exceptions for the RDREC:

- STATUS[4] contains the target area length from RECORD, if MLEN > the destination area length from RECORD.
- STATUS[4]=MLEN, if the actual data record length < MLEN < the destination area length from RECORD.
- STATUS[4]=0, if STATUS[4] > 255; would have to be set

In PROFINET IO, STATUS[4] has the value 0.

8.3.5 DPRD_DAT and DPWR_DAT (Read/write consistent data for DP slaves) instructions

You can use the DPRD_DAT (Read consistent data) and DPWR_DAT (Write consistent data) instructions with PROFINET and PROFIBUS.

Table 8- 78 DPRD_DAT and DPWR_DAT instructions

| LAD / FBD | SCL | Description |
|-----------|--|---|
| | <pre>ret_val := DPRD_DAT(laddr:=_word_in_, record=>_variant_out_);</pre> | <p>Use the DPRD_DAT instruction to read the consistent data of a DP standard slave/PROFINET IO device. If no errors occur during the data transfer, the data read is entered into the target area set up by the RECORD parameter. The target area must have the same length as you configured with STEP 7 for the selected module. When you call the DPRD_DAT instruction, you can only access the data of one module / DP identification under the configured start address.</p> |
| | <pre>ret_val := DPWR_DAT(laddr:=_word_in_, record:=_variant_in_);</pre> | <p>Use the DPWR_DAT instruction to transfer the data in RECORD consistently to the addressed DP standard slave/PROFINET IO device. The source area must have the same length as you configured with STEP 7 for the selected module.</p> |

The CPU supports up to 64 bytes of consistent data. For consistent data areas greater than 64 bytes, the DPRD_DAT and DPWR_DAT instructions must be used. If required, these instructions can be used for data areas of 1 byte or greater. If access is rejected, error code W#16#8090 will result.

Note

If you are using the DPRD_DAT and DPWR_DAT instructions with consistent data, you must remove this consistent data from the process-image automatic update. Refer to "PLC concepts: Execution of the user program" (Page 77) for more information.

Table 8- 79 Data types for the parameters

| Parameter and type | Data type | Description |
|--------------------|-----------|--|
| LADDR | IN | HW_IO (Word) <ul style="list-style-type: none"> Configured start address from the "I" area of the module from which the data will be read (DPRD_DAT) Configured start address from the process image output area of the module to which the data will be written (DPWR_DAT) Addresses have to be entered in hexadecimal format (for example, an input or output address of 100 means: LADDR:=W#16#64). |
| RECORD | OUT | Variant <p>Destination area for the user data that were read (DPRD_DAT) or source area for the user data to be written (DPWR_DAT). This must be exactly as large as you configured for the selected module with STEP 7.</p> |
| RET_VAL | OUT | Int <p>If an error occurs while the function is active, the return value contains an error code.</p> |

DPRD_DAT operations

The destination area must have the same length as configured for the selected module with STEP 7. If no error occurs during the data transfer, the data that have been read are entered into the destination area identified by RECORD.

If you read from a DP standard slave with a modular design or with several DP identifiers, you can only access the data of one module/DP identifier for each DPRD_DAT instruction call, specifying the configured start address.

DPWR_DAT operations

You transfer the data in RECORD consistently to the addressed DP standard slave/PROFINET IO. The data is transferred synchronously, that is, the write process is completed when the instruction is completed.

The source area must have the same length as you configured for the selected module with STEP 7.

If the DP standard slave has a modular design, you can only access one module of the DP slave.

Table 8- 80 DPRD_DAT and DPWR_DAT error codes

| Error code | Description |
|------------|--|
| 0000 | No error occurred |
| 8090 | One of the following cases apply: <ul style="list-style-type: none"> You have not configured a module for the specified logical base address. You have ignored the restriction concerning the length of consistent data. You have not entered the start address in the LADDR parameter in hexadecimal format. |
| 8092 | The RECORD parameter supports the following data types: Byte, Char, Word, DWord, Int, UInt, USInt, SInt, DInt, UInt, and arrays of these types. |
| 8093 | No DP module/PROFINET IO device from which you can read (DPRD_DAT) or to which you can write (DPWR_DAT) consistent data exists at the logical address specified in LADDR. |
| 80A0 | Access error detected while the I/O devices were being accessed (DPRD_DAT). |
| 80A1 | Access error detected while the I/O devices were being accessed (DPWR_DAT). |
| 80B0 | Slave failure on external DP interface module (DPRD_DAT) and (DPWR_DAT) |
| 80B1 | The length of the specified destination (DPRD_DAT) or source (DPWR_DAT) area is not identical to the user data length configured with STEP 7 Basic. |
| 80B2 | System error with external DP interface module (DPRD_DAT) and (DPWR_DAT) |
| 80B3 | System error with external DP interface module (DPRD_DAT) and (DPWR_DAT) |
| 80C0 | The data have not yet been read by the module (DPRD_DAT). |
| 80C1 | The data of the previous write job on the module have not yet been processed by the module (DPWR_DAT). |
| 80C2 | System error with external DP interface module (DPRD_DAT) and (DPWR_DAT) |
| 80Fx | System error with external DP interface module (DPRD_DAT) and (DPWR_DAT) |
| 85xy | System error with external DP interface module (DPWR_DAT) |
| 87xy | System error with external DP interface module (DPRD_DAT) |

| Error code | Description |
|------------|--|
| 808x | System error with external DP interface module (DPRD_DAT) |
| 8xyy | General error information Refer to "Common error codes for the 'Extended' instructions" (Page 407) for more information on general error codes. |

x = parameter number

y = event number

Note

If you access DPV1 slaves, error information from these slaves can be forwarded from the DP master to the instruction.

8.3.6 DPNRM_DG (Read diagnostic data from a DP slave) instruction

You can use the DPNRM_DG (Read diagnostic data) instruction with PROFIBUS.

Table 8- 81 DPNRM_DG instruction

| LAD / FBD | SCL | Description |
|---|---|--|
|  | <pre>ret_val := DPNRM_DG(req:= bool_in_, laddr:= word_in_, record=>_variant_out_, busy=> bool_out);</pre> | Use the DPNRM_DG instruction to read the current diagnostic data of a DP slave in the format specified by EN 50 170 Volume 2, PROFIBUS. The data that has been read is entered in the destination area indicated by RECORD following error-free data transfer. |

Table 8- 82 DPNRM_DG instruction data types for the parameters

| Parameter and type | | Data type | Description |
|--------------------|-----|-------------|---|
| REQ | IN | Bool | REQ=1: Read request |
| LADDR | IN | HW_DP_SLAVE | Configured diagnostic address of the DP slave: Must be the address of the station and not for the I/O device. Select the station (and not the image of the device) in the "Network" view of the "Device configuration" to determine the diagnostic address. Enter the addresses in hexadecimal format. For example, diagnostic address 1022 means LADDR:=W#16#3FE. |
| RET_VAL | OUT | Int | If an error occurs while the function is active, the return value contains an error code. If no error occurs, the length of the data actually transferred is entered in RET_VAL. |

| Parameter and type | | Data type | Description |
|--------------------|-----|-----------|---|
| RECORD | OUT | VARIANT | Destination area for the diagnostic data that were read. The minimum length of the data record to be read (or the destination area) is 6 bytes. The maximum length of the data record to be sent is 240 bytes. Standard slaves can provide more than 240 bytes of diagnostic data up to a maximum of 244 bytes. In this case, the first 240 bytes are transferred to the destination area, and the overflow bit is set in the data. |
| BUSY | OUT | Bool | BUSY=1: The read job is not yet completed |

You start the read job by assigning 1 to the input parameter REQ in the DPNRM_DG instruction call. The read job is executed asynchronously, in other words, it requires several DPNRM_DG instruction calls. The status of the job is indicated by the output parameters RET_VAL and BUSY.

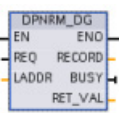
Table 8- 83 Slave diagnostic data structure

| Byte | Description |
|-------|--|
| 0 | Station status 1 |
| 1 | Station status 2 |
| 2 | Station status 3 |
| 3 | Master station number |
| 4 | Vendor ID (high byte) |
| 5 | Vendor ID (low byte) |
| 6 ... | Additional slave-specific diagnostic information |

Table 8- 84 DPNRM_DG instruction error codes

| Error code | Description | Restriction |
|------------|---|------------------|
| 0000 | No error | - |
| 7000 | First call with REQ=0: No data transfer active; BUSY has the value 0. | - |
| 7001 | First call with REQ =1: No data transfer active; BUSY has the value 1. | Distributed I/Os |
| 7002 | Interim call (REQ irrelevant): Data transfer already active; BUSY has the value 1. | Distributed I/Os |
| 8090 | Specified logical base address invalid: There is no base address. | - |
| 8092 | The RECORD parameter supports the following data types: Byte, Char, Word, DWord, Int, UInt, USInt, SInt, DInt, UDInt, and arrays of these types. | - |
| 8093 | <ul style="list-style-type: none"> This instruction is not permitted for the module specified by LADDR (S7-DP modules for S7-1200 are permitted). LADDR specifies the I/O device instead of specifying the station. Select the station (and not the image of the device) in the "Network" view of the "Device configuration" to determine the diagnostic address for LADDR. | - |
| 80A2 | <ul style="list-style-type: none"> DP protocol error at layer 2 (for example, slave failure or bus problems) For ET200S, data record cannot be read in DPV0 mode. | Distributed I/Os |
| 80A3 | DP protocol error with user interface/user | Distributed I/Os |

| Error code | Description | Restriction |
|-------------------|--|--|
| 80A4 | Communication problem on the communication bus | The error occurs between the CPU and the external DP interface module. |
| 80B0 | <ul style="list-style-type: none"> The instruction is not possible for module type. The module does not recognize the data record. Data record number 241 is not permitted. | - |
| 80B1 | The length specified in the RECORD parameter is incorrect. | Specified length > record length |
| 80B2 | The configured slot is not occupied. | - |
| 80B3 | Actual module type does not match the required module type. | - |
| 80C0 | There is no diagnostic information. | - |
| 80C1 | The data of the previous write job for the same data record on the module have not yet been processed by the module. | - |
| 80C2 | The module is currently processing the maximum possible number of jobs for a CPU. | - |
| 80C3 | The required resources (memory, etc.) are currently occupied. | - |
| 80C4 | Internal temporary error. The job could not be processed. Repeat the job. If this error occurs frequently, check your system for electrical disturbance sources. | - |
| 80C5 | Distributed I/Os not available | Distributed I/Os |
| 80C6 | Data record transfer was stopped due to a priority class abort (restart or background) | Distributed I/Os |
| 8xyy ¹ | General error codes | |

Refer to "Extended instructions, Distributed I/O: Error information for RDREC, WRREC, and RALRM" (Page 322) for more information on general error codes.

8.4 Interrupts

8.4.1 ATTACH and DETACH (Attach/detach an OB and an interrupt event) instructions

You can activate and deactivate interrupt event-driven subprograms with the ATTACH and DETACH instructions.

Table 8- 85 ATTACH and DETACH instructions

| LAD / FBD | SCL | Description |
|--|--|---|
|  | <pre>ret_val := ATTACH(ob_nr:=_int_in_, event:=_event_att_in_, add:=_bool_in_);</pre> | ATTACH enables interrupt OB subprogram execution for a hardware interrupt event. |
|  | <pre>ret_val := DETACH(ob_nr:=_int_in_, event:=_event_att_in_);</pre> | DETACH disables interrupt OB subprogram execution for a hardware interrupt event. |

Table 8- 86 Data types for the parameters

| Parameter and type | | Data type | Description |
|----------------------|-----|-----------|--|
| OB_NR | IN | OB_ATT | Organization block identifier: Select from the available hardware interrupt OBs that were created using the "Add new block" feature. Double-click on the parameter field, then click on the helper icon to see the available OBs. |
| EVENT | IN | EVENT_ATT | Event identifier: Select from the available hardware interrupt events that were enabled in PLC device configuration for digital inputs or high-speed counters. Double-click on the parameter field, then click on the helper icon to see the available events. |
| ADD (ATTACH only) | IN | Bool | <ul style="list-style-type: none"> ADD = 0 (default): This event replaces all previous event attachments for this OB. ADD = 1: This event is added to previous event attachments for this OB. |
| RET_VAL | OUT | Int | Execution condition code |

Hardware interrupt events

The following hardware interrupt events are supported by the CPU:

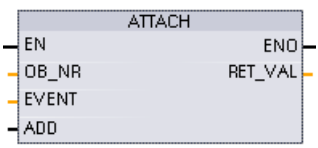
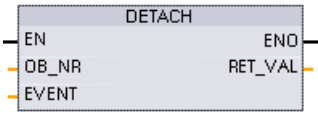
- Rising edge events: first 12 built-in CPU digital inputs (DIa.0 to DIb.3) and all SB digital inputs
 - A rising edge occurs when the digital input transitions from OFF to ON as a response to a change in the signal from a field device connected to the input.
- Falling edge events: first 12 built-in CPU digital inputs (DIa.0 to DIb.3) and all SB digital inputs
 - A falling edge occurs when the digital input transitions from ON to OFF.
- High-speed counter (HSC) current value = reference value (CV = RV) events (HSC 1 through 6)
 - A CV = RV interrupt for a HSC is generated when the current count transitions from an adjacent value to the value that exactly matches a reference value that was previously established.
- HSC direction changed events (HSC 1 through 6)
 - A direction changed event occurs when the HSC is detected to change from increasing to decreasing, or from decreasing to increasing.
- HSC external reset events (HSC 1 through 6)
 - Certain HSC modes allow the assignment of a digital input as an external reset that is used to reset the HSC count value to zero. An external reset event occurs for such a HSC, when this input transitions from OFF to ON.

Enabling hardware interrupt events in the device configuration

Hardware interrupts must be enabled during the device configuration. You must check the enable-event box in the device configuration for a digital input channel or a HSC, if you want to attach this event during configuration or run time.

Check box options within the PLC device configuration:

- Digital input
 - Enable rising edge detection
 - Enable falling edge detection
- High-speed counter (HSC)
 - Enable this high-speed counter for use
 - Generate interrupt for counter value equals reference value count
 - Generate interrupt for external reset event
 - Generate interrupt for direction change event

Adding new hardware interrupt OB code blocks to your program

By default, no OB is attached to an event when the event is first enabled. This is indicated by the "HW interrupt:" device configuration "<not connected>" label. Only hardware-interrupt OBs can be attached to a hardware interrupt event. All existing hardware-interrupt OBs appear in the "HW interrupt:" drop-down list. If no OB is listed, then you must create an OB of type "Hardware interrupt" as follows. Under the project tree "Program blocks" branch:

1. Double-click "Add new block", select "Organization block (OB)" and choose "Hardware interrupt".
2. Optionally, you can rename the OB, select the programming language (LAD, FBD or SCL), and select the block number (switch to manual and choose a different block number than that suggested).
3. Edit the OB and add the programmed reaction that you want to execute when the event occurs. You can call FCs and FBs from this OB, to a nesting depth of six.

OB_NR parameter

All existing hardware-interrupt OB names appear in the device configuration "HW interrupt:" drop-down list and in the ATTACH / DETACH parameter OB_NR drop-list.

EVENT parameter

When a hardware interrupt event is enabled, a unique default event name is assigned to this particular event. You can change this event name by editing the "Event name:" edit box, but it must be a unique name. These event names become tag names in the "Constants" tag table, and appear on the EVENT parameter drop-down list for the ATTACH and DETACH instruction boxes. The value of the tag is an internal number used to identify the event.

General operation

Each hardware event can be attached to a hardware-interrupt OB which will be queued for execution when the hardware interrupt event occurs. The OB-event attachment can occur at configuration time or at run time.

You have the option to attach or detach an OB to an enabled event at configuration time. To attach an OB to an event at configuration time, you must use the "HW interrupt:" drop-down list (click on the down arrow on the right) and select an OB from the list of available hardware-interrupt OBs. Select the appropriate OB name from this list, or select "<not connected>" to remove the attachment.

You can also attach or detach an enabled hardware interrupt event during run time. Use the ATTACH or DETACH program instructions during run time (multiple times if you wish) to attach or detach an enabled interrupt event to the appropriate OB. If no OB is currently attached (either from a "<not connected>" selection in device configuration, or as a result of executing a DETACH instruction), the enabled hardware interrupt event is ignored.

DETACH operation

Use the DETACH instruction to detach either a particular event or all events from a particular OB. If an EVENT is specified, then only this one event is detached from the specified OB_NR; any other events currently attached to this OB_NR will remain attached. If no EVENT is specified, then all events currently attached to OB_NR will be detached.

Condition codes

Table 8- 87 Condition codes

| RET_VAL (W#16#....) | ENO | Description |
|---------------------|-----|---------------------------------|
| 0000 | 1 | No error |
| 0001 | 1 | Nothing to Detach (DETACH only) |
| 8090 | 0 | OB does not exist |
| 8091 | 0 | OB is wrong type |
| 8093 | 0 | Event does not exist |

8.4.2 Cyclic interrupts

8.4.2.1 SET_CINT (Set cyclic interrupt parameters) instruction

Table 8- 88 SET_CINT (Set cyclic interrupt parameters)

| LAD / FBD | SCL | Description |
|---|---|--|
|  | <pre>ret_val := SET_CINT(ob_nr:=_int_in_, cycle:=_udint_in_, phase:=_udint_in_);</pre> | Set the specified interrupt OB to begin cyclic execution that interrupts the program scan. |

Table 8- 89 Data types for the parameters

| Parameter and type | Data type | Description |
|--------------------|-----------|-----------------------------------|
| OB_NR IN | OB_CYCLIC | OB number (accepts symbolic name) |
| CYCLE IN | UDInt | Time interval, in microseconds |
| PHASE IN | UDInt | Phase shift, in microseconds |
| RET_VAL OUT | Int | Execution condition code |

Time parameter examples:

- If the CYCLE time = 100 us, then the interrupt OB referenced by OB_NR interrupts the cyclic program scan every 100 us. The interrupt OB executes and then returns execution control to the program scan, at the point of interruption.
- If the CYCLE time = 0, then the interrupt event is deactivated and the interrupt OB is not executed.
- The PHASE (phase shift) time is a specified delay time that occurs before the CYCLE time interval begins. You can use the phase shift to control the execution timing of lower priority OBs.

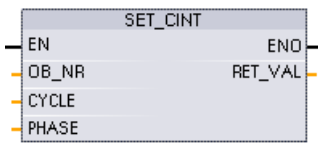
If lower and higher priority OBs are called in the same time interval, the lower priority OB is only called after the higher priority OB has finished processing. The execution start time for the low priority OB can shift depending on the processing time of higher priority OBs.

OB call without phase shift

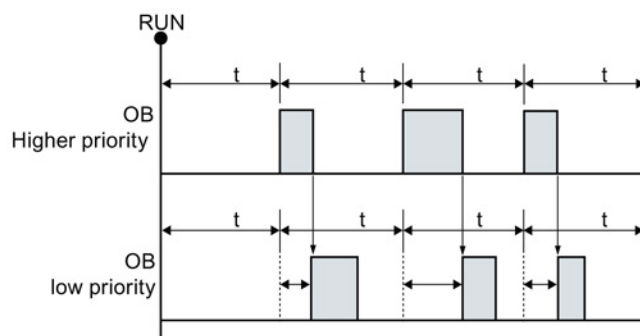

If you want to start the execution of a lower priority OB on a fixed time cycle, then phase shift time should be greater than the processing time of higher priority OBs.

OB-call with phase shift

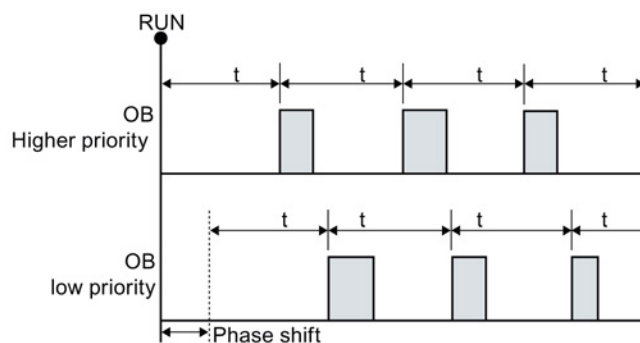

Table 8- 90 Condition codes

| RET_VAL (W#16#...) | Description |
|--------------------|---------------------------------------|
| 0000 | No error |
| 8090 | OB does not exist or is of wrong type |
| 8091 | Invalid cycle time |

| RET_VAL (W#16#...) | Description |
|--------------------|--------------------------|
| 8092 | Invalid phase shift time |
| 80B2 | OB has no attached event |

8.4.2.2 QRY_CINT (Query cyclic interrupt parameters) instruction

Table 8- 91 QRY_CINT (Query cyclic interrupt)

| LAD / FBD | SCL | Description |
|-----------|--|---|
| | <pre>ret_val := QRY_CINT(ob_nr:=_int_in_, cycle=>_udint_out_, phase=>_udint_out_, status=>_word_out_);</pre> | <p>Get parameter and execution status from a cyclic interrupt OB. The values that are returned existed at the time QRY_CINT was executed.</p> |

Table 8- 92 Data types for the parameters

| Parameter and type | Data type | Description |
|--------------------|-----------|---|
| OB_NR IN | OB_CYCLIC | OB number (accepts symbolic name like OB_MyOBName) |
| RET_VAL OUT | Int | Execution condition code |
| CYCLE OUT | UDInt | Time interval, in microseconds |
| PHASE OUT | UDInt | Phase shift, in microseconds |
| STATUS OUT | Word | Cyclic interrupt status code: <ul style="list-style-type: none"> • Bits 0 to 4, see the STATUS table below • Other bits, always 0 |

Table 8- 93 STATUS parameter

| Bit | Value | Description |
|------------|-------|--|
| 0 | 0 | During CPU RUN |
| | 1 | During startup |
| 1 | 0 | The interrupt is enabled. |
| | 1 | Interrupt is disabled via the DIS_IRT instruction. |
| 2 | 0 | The interrupt is not active or has elapsed. |
| | 1 | The interrupt is active. |
| 4 | 0 | The OB identified by OB_NR does not exist. |
| | 1 | The OB identified by OB_NR exists. |
| Other Bits | | Always 0 |

If an error occurs, RET_VAL displays the appropriate error code and the parameter STATUS = 0.

Table 8- 94 RET_VAL parameter

| RET_VAL (W#16#...) | Description |
|--------------------|--|
| 0000 | No error |
| 8090 | OB does not exist or is of wrong type. |
| 80B2 | OB has no attached event. |

8.4.3 Time of day interrupts

|  WARNING |
|---|
| <p>If an attacker can access your networks through Network Time Protocol (NTP) synchronization, the attacker can possibly take limited control of your process by shifting the CPU system time.</p> <p>The NTP client feature of the S7-1200 CPU is disabled by default, and, when enabled, only allows configured IP addresses to act as an NTP server. The CPU disables this feature by default, and you must configure this feature to allow remotely-controlled CPU system time corrections.</p> <p>The S7-1200 CPU supports "time of day" interrupts and clock instructions that depend upon accurate CPU system time. If you configure NTP and accept time synchronization from a server, you must ensure that the server is a trusted source. Failure to do so can cause a security breach that allows an unknown user to take limited control of your process by shifting the CPU system time.</p> <p>For security information and recommendations, please see our "Operational Guidelines for Industrial Security" (http://www.industry.siemens.com/topics/global/en/industrial-security/Documents/operational_guidelines_industrial_security_en.pdf) on the Siemens Service and Support site.</p> |

8.4.3.1 SET_TINTL (Set time of day interrupt)

Table 8- 95 SET_TINTL (Set date and time of day interrupt with DTL data type)

| LAD / FBD | SCL | Description |
|---|---|--|
|  | <pre>ret_val := SET_TINTL(OB_NR:=_int_in_, SDT:=_dtl_in_, LOCAL:=_bool_in_ PERIOD:=_word_in_ ACTIVATE:=_bool_in_);</pre> | <p>Set a date and time of day interrupt. The program interrupt OB can be set for one execution, or for recurring execution with an assigned time period.</p> |

Table 8- 96 Data types for the parameters

| Parameter and type | | Data type | Description |
|--------------------|-----|--------------|--|
| OB_NR | IN | OB_TOD (INT) | OB number (accepts symbolic name) |
| SDT | IN | DTL | Start date and time: Seconds and milliseconds are ignored and can be set to 0. |
| LOCAL | IN | Bool | 0 = Use system time 1 = Use local time (if the CPU is configured for local time, otherwise use system time) |
| PERIOD | IN | Word | The period from the starting date and time for recurring interrupt event. <ul style="list-style-type: none"> • W#16#0000 = Once • W#16#0201 = Every minute • W#16#0401 = Every hour • W#16#1001 = Daily • W#16#1201 = Weekly • W#16#1401 = Monthly • W#16#1801 = yearly • W#16#2001 = End of month |
| ACTIVATE | IN | Bool | 0 = ACT_TINT must be executed to activate the interrupt event. 1 = The interrupt event is activated. |
| RET_VAL | OUT | Int | Execution condition code |

Your program can use SET_TINTL to set a date and time of day interrupt event that will execute the assigned interrupt OB. The start date and time is set by parameter SDT and the time period for recurring interrupts (for example, daily or weekly) is set by parameter PERIOD. If you set the repetition period to monthly, then you must set the start date to a day from 1 to 28. The days 29 to 31 may not be used because they do not occur in February. If you want an interrupt event at the end of each month, then use end of month for parameter PERIOD.

The DTL data weekday value in parameter SDT is ignored. Set a CPU's current date and time using the "Set time of day" function in the "Online & diagnostics" view of an online CPU. You must set the month, day of month, and year. STEP 7 calculates the interrupt period based on the CPU date and time clock.

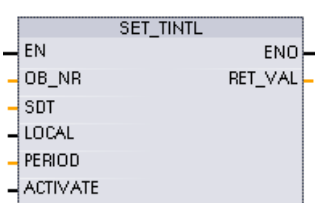
Note

The first hour of the day does not exist when changing from summer to winter (daylight saving time). Use a start time within the second hour or use an additional time delay interrupt within the first hour.

Table 8- 97 Condition code

| RET_VAL (W#16#....) | Description |
|---------------------|--|
| 0000 | No error |
| 8090 | Invalid OB_NR parameter |
| 8091 | Invalid SDT start time parameter: (for example, a start time within the skipped hour at the start of daylight savings time) |
| 8092 | Invalid PERIOD parameter |
| 80A1 | The start time is in the past. (This error code only occurs with PERIOD = W #16#0000.) |

8.4.3.2 CAN_TINT (Cancel time of day interrupt)

Table 8- 98 CAN_TINT (Cancel date and time of day interrupt)

| LAD / FBD | SCL | Description |
|-----------|--|--|
| | <pre>ret_val:=CAN_TINT(_int_in);</pre> | Cancels the start date and time of day interrupt event for the specified interrupt OB. |

Table 8- 99 Data types for the parameters

| Parameter and type | Data type | Description |
|--------------------|--------------|-----------------------------------|
| OB_NR IN | OB_TOD (INT) | OB number (accepts symbolic name) |
| RET_VAL OUT | Int | Execution condition code |

Table 8- 100 Condition codes

| RET_VAL (W#16#....) | Description |
|---------------------|--|
| 0000 | No error |
| 8090 | Invalid OB_NR parameter |
| 80A0 | No start date / time set for that interrupt OB |

8.4.3.3 ACT_TINT (Activate time of day interrupt)

Table 8- 101 ACT_TINT (Activate date and time of day interrupt)

| LAD / FBD | SCL | Description |
|-----------|--|--|
| | <pre>ret_val:=ACT_TINT(_int_in);</pre> | Activates the start date and time of day interrupt event for the specified interrupt OB. |

Table 8- 102 Data types for the parameters

| Parameter and type | | Data type | Description |
|--------------------|-----|--------------|-----------------------------------|
| OB_NR | IN | OB_TOD (INT) | OB number (accepts symbolic name) |
| RET_VAL | OUT | Int | Execution condition code |

Table 8- 103 Condition codes

| RET_VAL (W#16#...) | Description |
|--------------------|---|
| 0000 | No error |
| 8090 | Invalid OB_NR parameter |
| 80A0 | Start date and time-of day not set, for the relevant time-of-day interrupt OB |
| 80A1 | The activated time is in the past. The error only occurs when the interrupt OB is set to execute once only. |

8.4.3.4 QRY_TINT (Query status of time of day interrupt)

Table 8- 104 QRY_TINT (Query date and time of day interrupt)

| LAD / FBD | SCL | Description |
|-----------|--|--|
| | <pre>ret_val:=QRY_TINT(OB_NR:=_int_in_, STATUS=>_word_out_);</pre> | <p>Queries the date and time of day interrupt status for the specified interrupt OB.</p> |

Table 8- 105 Data types for the parameters

| Parameter and type | | Data type | Description |
|--------------------|-----|--------------|--|
| OB_NR | IN | OB_TOD (INT) | OB number (accepts symbolic name) of the interrupt OB to query |
| RET_VAL | OUT | Int | Execution condition code |
| STATUS | OUT | Word | Status of the specified interrupt OB |

Table 8- 106 STATUS parameter

| Bit | Value | Description |
|--------|-------|--|
| 0 | 0 | In Run |
| | 1 | In Startup |
| 1 | 0 | The interrupt is enabled. |
| | 1 | The interrupt is disabled. |
| 2 | 0 | The interrupt is not active or has expired. |
| | 1 | The interrupt is active. |
| 4 | 0 | The assigned OB_NR does not exist. |
| | 1 | An OB with the assigned OB_NR exists. |
| 6 | 1 | The date and time of day interrupt uses local time. |
| | 0 | The date and time of day interrupt uses system time. |
| Others | | Always 0 |

Table 8- 107 Condition code

| RET_VAL (W#16#....) | Description |
|---------------------|-------------------------|
| 0000 | No error |
| 8090 | Invalid OB_NR parameter |

8.4.4 Time delay interrupts

You can start and cancel time delay interrupt processing with the SRT_DINT and CAN_DINT instructions, or query the interrupt status with the QRY_DINT instruction. Each time delay interrupt is a one-time event that occurs after the specified delay time. If the time delay event is cancelled before the time delay expires, the program interrupt does not occur.

Table 8- 108 SRT_DINT, CAN_DINT, and QRY_DINT instructions

| LAD / FBD | SCL | Description |
|-----------|--|---|
| | <pre>ret_val := SRT_DINT(ob_nr:=_int_in_, dtime:=_time_in_, sign:=_word_in_);</pre> | SRT_DINT starts a time delay interrupt that executes an OB when the delay time specified by parameter DTIME has elapsed. |
| | <pre>ret_val := CAN_DINT(ob_nr:=_int_in_);</pre> | CAN_DINT cancels a time delay interrupt that has already started. The time delay interrupt OB is not executed in this case. |
| | <pre>ret_val := QRY_DINT(ob_nr:=_int_in_, status=>_word_out_);</pre> | QRY_DINT queries the status of the time delay interrupt specified by the OB_NR parameter. |

Table 8- 109 Data types for the parameters

| Parameter and type | Data type | Description |
|-----------------------|-----------|---|
| OB_NR IN | OB_DELAY | Organization block (OB) to be started after a time-delay: Select from the available time-delay interrupt OBs that were created using the "Add new block" project tree feature. Double-click on the parameter field, then click on the helper icon to see the available OBs. |
| DTIME ¹ IN | Time | Time delay value (1 to 60000 ms) |
| SIGN ¹ IN | Word | Not used by the S7-1200: Any value is accepted. A value must be assigned to prevent errors. |
| RET_VAL OUT | Int | Execution condition code |
| STATUS OUT | Word | QRY_DINT instruction: Status of the specified time-delay interrupt OB, see the table below |

¹ Only for SRT_DINT

Operation

The SRT_DINT instruction specifies a time delay, starts the internal time delay timer, and associates a time delay interrupt OB subprogram with the time delay timeout event. When the specified time delay has elapsed, a program interrupt is generated that triggers the execution of the associated time delay interrupt OB. You can cancel an in-process time delay interrupt before the specified time delay occurs by executing the CAN_DINT instruction. The total number of active time delay interrupt events must not exceed four.

Adding time delay interrupt OB subprograms to your project

Only time delay interrupt OBs can be assigned to the SRT_DINT and CAN_DINT instructions. No time delay interrupt OB exists in a new project. You must add time delay interrupt OBs to your project. To create a time-delay interrupt OB, follow these steps:

1. Double-click the "Add new block" item in the "Program blocks" branch of the project tree, select "Organization block (OB)", and choose "Time delay interrupt".
2. You have the option to rename the OB, select the programming language, or select the block number. Switch to manual numbering if you want to assign a different block number than the number that was assigned automatically.
3. Edit the time delay interrupt OB subprogram and create programmed reaction that you want to execute when the time delay timeout event occurs. You can call other FC and FB code blocks from the time delay interrupt OB, with a maximum nesting depth of six.
4. The newly assigned time delay interrupt OB names will be available when you edit the OB_NR parameter of the SRT_DINT and CAN_DINT instructions.

QRY_DINT parameter STATUS

Table 8- 110 If there is an error (REL_VAL <> 0), then STATUS = 0.

| Bit | Value | Description |
|------------|-------|--|
| 0 | 0 | In RUN |
| | 1 | In startup |
| 1 | 0 | The interrupt is enabled. |
| | 1 | The interrupt is disabled. |
| 2 | 0 | The interrupt is not active or has elapsed. |
| | 1 | The interrupt is active. |
| 4 | 0 | An OB with an OB number given in OB_NR does not exist. |
| | 1 | An OB with an OB number given in OB_NR exists. |
| Other bits | | Always 0 |

Condition codes

Table 8- 111 Condition codes for SRT_DINT, CAN_DINT, and QRY_DINT

| RET_VAL (W#16#...) | Description |
|--------------------|---------------------------------------|
| 0000 | No error occurred |
| 8090 | Incorrect parameter OB_NR |
| 8091 | Incorrect parameter DTIME |
| 80A0 | Time delay interrupt has not started. |

8.4.5 DIS_AIRT and EN_AIRT (Delay/enable execution of higher priority interrupts and asynchronous error events) instructions

Use the DIS_AIRT and EN_AIRT instructions to disable and enable alarm interrupt processing.

Table 8- 112 DIS_AIRT and EN_AIRT instructions

| LAD / FBD | SCL | Description |
|-----------|----------------|--|
| | DIS_AIRT () ; | DIS_AIRT delays the processing of new interrupt events. You can execute DIS_AIRT more than once in an OB. |
| | EN_AIRT () ; | EN_AIRT enables the processing of interrupt events that you previously disabled with the DIS_AIRT instruction. Each DIS_AIRT execution must be cancelled by an EN_AIRT execution. The EN_AIRT executions must occur within the same OB, or any FC or FB called from the same OB, before interrupts are enabled again for this OB. |

Table 8- 113 Data types for the parameters

| Parameter and type | Data type | Description |
|--------------------|-----------|--|
| RET_VAL | OUT | Int |
| | | Number of delays = number of DIS_AIRT executions in the queue. |

The DIS_AIRT executions are counted by the operating system. Each of these remains in effect until it is cancelled again specifically by an EN_AIRT instruction, or until the current OB has been completely processed. For example: if you disabled interrupts five times with five DIS_AIRT executions, you must cancel these with five EN_AIRT executions before interrupts become enabled again.

After the interrupt events are enabled again, the interrupts that occurred while DIS_AIRT was in effect are processed, or the interrupts are processed as soon as the current OB has been executed.

Parameter RET_VAL indicates the number of times that interrupt processing was disabled, which is the number of queued DIS_AIRT executions. Interrupt processing is only enabled again when parameter RET_VAL = 0.

8.5 Diagnostics (PROFINET or PROFIBUS)

8.5.1 Diagnostic instructions

The following diagnostic instructions can be used with either PROFINET or PROFIBUS:

- GET_DIAG instruction (Page 358): You can read the diagnostic information from a specified device.
- DeviceStates instruction (Page 347): You can retrieve the operational states for a distributed I/O device within an I/O subsystem.
- ModuleStates instruction (Page 353): You can retrieve the operational states for the modules in a distributed I/O device.
- LED instruction (Page 346): You can read the state of the LEDs for a distributed I/O device.

8.5.2 Diagnostic events for distributed I/O

Note

With a PROFIBUS IO system, after a download or power cycle, the CPU will go to RUN mode unless the hardware compatibility is set to allow acceptable substitute modules (Page 142) and one or more modules is missing or is not an acceptable substitute for the configured module.

As shown in the following table, the CPU supports diagnostics that can be configured for the components of the distributed I/O system. Each of these errors generates a log entry in the diagnostic buffer.

Table 8- 114 Handling of diagnostic events for PROFINET and PROFIBUS

| Type of error | Diagnostic information for the station? | Entry in the diagnostic buffer? | CPU operating mode |
|--------------------------------------|---|---------------------------------|--------------------|
| Diagnostic error | Yes | Yes | Stays in RUN mode |
| Rack or station failure | Yes | Yes | Stays in RUN mode |
| I/O access error ¹ | No | Yes | Stays in RUN mode |
| Peripheral access error ² | No | Yes | Stays in RUN mode |
| Pull / plug event | Yes | Yes | Stays in RUN mode |

¹ I/O access error example cause: A module that has been removed.

² Peripheral access error example cause: Acyclic communication to a submodule that is not communicating.

Use the GET_DIAG instruction (Page 358) for each station to obtain the diagnostic information. This will allow you to programmatically handle the errors encountered on the device and if desired take the CPU to STOP mode. This method requires you to specify the hardware device from which to read the status information.

The GET_DIAG instruction uses the "L address" (LADDR) of the station to obtain the health of the entire station. This L Address can be found within the Network Configuration view and by selecting the entire station rack (entire gray area), the L Address is shown in the Properties Tab of the station. You can find the LADDR for each individual module either in the properties for the module (in the device configuration) or in the default tag table for the CPU.

8.5.3 LED (Read LED status) instruction

Table 8- 115 LED instruction

| LAD / FBD | SCL | Description |
|---|---|---|
|  | <pre>ret_val := LED(laddr:=_word_in_, LED:=_uint_in_);</pre> | Use the LED instruction to read the state of the LEDs on a CPU or interface. The specified LED state is returned by the RET_VAL output. |

Table 8- 116 Data types for the parameters

| Parameter and type | Data type | Description |
|--------------------|-----------|--|
| LADDR | IN | HW_IO |
| | | Identification number of the CPU or interface ¹ |
| LED | IN | UInt |
| | | LED identifier number |
| | | 1 RUN/STOP Color 1 = green, color 2 = yellow |
| | | 2 Error Color 1 = red |
| | | 3 Maintenance Color 1 = yellow |
| | | 4 Redundancy Not applicable |
| | | 5 Link Color 1 = green |
| | | 6 Tx/Rx Color 1 = yellow |
| RET_VAL | OUT | Int |
| | | Status of the LED |

¹ For example, you can select the CPU (such as "PLC_1") or the PROFINET interface from the drop-down list of the parameter.

Table 8- 117 Status of RET_VAL

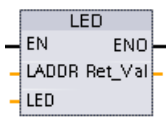
| RET_VAL (W#16#...) | Description | |
|--------------------|--|--|
| 0 to 9 LED state | 0 | LED does not exist |
| | 1 | Off |
| | 2 | Color 1 On (solid) |
| | 3 | Color 2 On (Solid) |
| | 4 | Color 1 flashing at 2 Hz |
| | 5 | Color 2 flashing 2 Hz |
| | 6 | Color 1 & 2 flashing alternatively at 2 Hz |
| | 7 | Color 1 on (Tx/Rx) |
| | 8 | Color 2 on (Tx/Rx) |
| | 9 | State of the LED is not available |
| 8091 | Device identified by LADDR does not exist | |
| 8092 | Device identified by LADDR does not support LEDs | |
| 8093 | LED identifier not defined | |
| 80Bx | CPU identified by LADDR does not support the LED instruction | |

8.5.4 DeviceStates instruction

You can use the DeviceStates instruction to return the states of all distributed I/O slave devices connected to a specified distributed I/O Master.

Table 8- 118 DeviceStates instruction

| LAD / FBD | SCL | Description |
|---|---|--|
|  | <pre>ret_val := DeviceStates(laddr:=hw_io_in_, mode:=_uint_in_, state:=_variant_inout_);</pre> | <p>DeviceStates retrieves the I/O device operational states of an I/O subsystem. After execution, the STATE parameter contains the error state of each I/O device in a bit list (for the assigned LADDR and MODE). This information corresponds with the device status seen in the STEP 7 diagnostics view.</p> <p>The LADDR input of DeviceStates uses the hardware identifier of a distributed I/O interface. In the TIA portal, the hardware identifiers for a PLC can be found by looking for "Hw_IoSystem" data types in the system constants tab in the PLC tag table.</p> |

Table 8- 119 Data types for the parameters

| Parameter and type | | Data type | Description |
|--------------------|-------|-------------|--|
| LADDR | IN | HW_IOSYSTEM | Logical address: (Identifier for the I/O system) |
| MODE | IN | UInt | Supports five modes of operation. The MODE input determines which data will be returned to the location specified for STATE information. The modes are as follows: <ul style="list-style-type: none"> • 1: Device configuration active • 2: Device defective • 3: Device disabled • 4: Device exists • 5: Problem in Device |
| RET_VAL | OUT | Int | Execution condition code |
| STATE ¹ | InOut | Variant | Buffer that receives the error status of each device: The data type that you choose for the STATE parameter can be any bit type (Bool, Byte, Word, or DWord) or an array of a bit type <ul style="list-style-type: none"> • Bit 0 of the first byte of the returned STATE data is a summary bit. When it is set to TRUE, it indicates that other data is available. • The data returned by the STATE parameter shows a one-to-one correlation between a bit location and a distributed I/O address. This device addressing is TRUE for PROFIBUS and PROFINET. For example, Bit 4 in the first Byte correlates to PROFIBUS address 4 or PROFINET device number 4. |

¹ For PROFIBUS-DP, the length of the status information is 128 bits. For PROFINET I/O, the length is 1024 bits.

After execution, the STATE parameter contains the error state of each I/O device as a bit list (for the assigned LADDR and MODE).

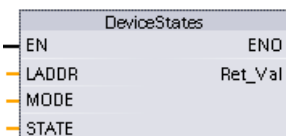
Table 8- 120 Condition codes

| RET_VAL (W#16#...) | Description |
|--------------------|--|
| 0 | No error |
| 8091 | LADDR does not exist. |
| 8092 | LADDR does not address an I/O system. |
| 8093 | Invalid data type assigned for STATE parameter: Valid data types are (Bool, Byte, Word, or Dword), or an array of (Bools, Bytes, Words, or Dwords) |
| 80Bx | DeviceStates instruction not supported by the CPU for this LADDR. |
| 8452 | The complete state data is too large for the assigned STATE parameter. The STATE buffer contains a partial result. |

8.5.4.1 DeviceStates example configurations

PROFIBUS example

The PROFIBUS example consists of the following:

- 16 PROFIBUS devices named "DPSlave_10" through "DPSlave_25"
- The 16 PROFIBUS devices use PROFIBUS addresses 10 through 25, respectively.
- Each slave device is configured with multiple I/O modules.
- The first four bytes of the returned STATE parameter information is displayed.

| MODE | Example 1: Normal operation with no errors | Example 2: PROFIBUS slave device DPSlave_12 with single module pulled | Example 3: PROFIBUS slave device DPSlave_12 disconnected |
|--------------------------------|--|---|---|
| 1: Device configuration active | 0x01FC_FF03 | 0x01FC_FF03 | 0x01FC_FF03 |
| 2: Device defective | 0x0000_0000 | 0x0110_0000 | 0x0110_0000 |
| 3: Device disabled | 0x0000_0000 | 0x0000_0000 | 0x0000_0000 |
| 4: Device exists | 0x01FC_FF03 | 0x01FC_FF03 | 0x01EC_FF03 |
| 5: Problem in device | 0x0000_0000 | 0x0110_0000 | 0x0110_0000 |

The following four tables show a binary breakdown of the four bytes of data that are being analyzed:

Table 8- 121 Example 1: No errors: A value of 0x01FC_FF03 is returned for MODE 1 (Device configuration active).

| Byte with value | Bit pattern with value | Notes |
|-----------------|-------------------------|-----------------------------------|
| Byte 1 0x01 | Bit 7 0000-0001 Bit 0 | Bit 0 is true; data is available. |
| Byte 2 0xFC | Bit 15 1111-1100 Bit 8 | |
| Byte 3 0xFF | Bit 23 1111-1111 Bit 16 | |
| Byte 4 0x03 | Bit 31 0000-0011 Bit 24 | |

The devices are configured in addresses 10 (Bit 10) through 25 (Bit 25).

No devices are configured in addresses 1 through 9.

MODE 4 (Device exists) data matches MODE 1 (Device configuration active), so the configured devices match the existing devices.

8.5 Diagnostics (PROFINET or PROFIBUS)

Table 8- 122 Example 2: A module has been pulled from PROFIBUS slave device "DPSlave_12". A value of 0x0110_0000 is returned for MODE 2 (Device defective).

| Byte with value | Bit pattern with value | Notes |
|-----------------|-------------------------|-----------------------------------|
| Byte 1 0x01 | Bit 7 0000-0001 Bit 0 | Bit 0 is true; data is available. |
| Byte 2 0x10 | Bit 15 0001-0000 Bit 8 | |
| Byte 3 0x00 | Bit 23 0000-0000 Bit 16 | |
| Byte 4 0x00 | Bit 31 0000-0000 Bit 24 | |

Device 12 (Bit 12) is marked as defective.

MODE 5 (Problem in device) returns the same information as MODE 2 (Device defective).

Table 8- 123 Example 2 (continued): A module has been pulled from PROFIBUS slave device "DPSlave_12". A value of 0x01FC_FF03 is returned for MODE 4 (Device exists).

| Byte with value | Bit pattern with value | Notes |
|-----------------|-------------------------|-----------------------------------|
| Byte 1 0x01 | Bit 7 0000-0001 Bit 0 | Bit 0 is true; data is available. |
| Byte 2 0xFC | Bit 15 1111-1100 Bit 8 | |
| Byte 3 0xFF | Bit 23 1111-1111 Bit 16 | |
| Byte 4 0x03 | Bit 31 0000-0011 Bit 24 | |

Even though device 12 (Bit 12) has an error as shown in MODE 2 (Device defective) above, the device is still functioning on the network which causes MODE 4 (Device exists) to show the device as an "existing device".

Table 8- 124 Example 3: PROFIBUS slave device "DPSlave_12" is disconnected (cable disconnected or power loss) from the PROFIBUS network. "DPSlave_12" is still detected as a defective device as well as an error in the device. The difference is that "DPSlave_12" is no longer detected as a device that exists. A value of 0x01EC_FF03 is returned for MODE 4 (Device exists).

| Byte with value | Bit pattern with value | Notes |
|-----------------|-------------------------|-----------------------------------|
| Byte 1 0x01 | Bit 7 0000-0001 Bit 0 | Bit 0 is true; data is available. |
| Byte 2 0xEC | Bit 15 1110-1100 Bit 8 | |
| Byte 3 0xFF | Bit 23 1111-1111 Bit 16 | |
| Byte 4 0x03 | Bit 31 0000-0011 Bit 24 | |

Device 12 (Bit 12) is marked as not existing. With this exception, devices 10 through 25 still report as existing.

PROFINET example

The PROFINET example consists of the following:

- 16 PROFINET slave devices named "et200s_1" through "et200s_16"
- The 16 PROFINET devices use PROFINET device numbers 1 through 16, respectively.
- Each slave device is configured with multiple I/O modules.
- The first four bytes of the returned STATE parameter information is displayed.

| MODE | Example 1: Normal operation with no errors | Example 2: PROFINET slave et200s_1 module pulled | Example 3: PROFINET slave et200s_1 disconnected |
|--------------------------------|--|---|--|
| 1: Device configuration active | 0xFFFF_0100 | 0xFFFF_0100 | 0xFFFF_0100 |
| 2 - Device defective | 0x0000_0000 | 0x0300_0000 | 0x0300_0000 |
| 3 - Device disabled | 0x0000_0000 | 0x0000_0000 | 0x0000_0000 |
| 4 - Device exists | 0xFFFF_0100 | 0xFFFF_0100 | 0xFDFF_0100 |
| 5 - Problem in device | 0x0000_0000 | 0x0300_0000 | 0x0300_0000 |

The following four tables show a binary breakdown of the four bytes of data that are being analyzed:

Table 8- 125 Example 1: No errors: A value of 0xFFFF_0100 is returned for MODE 1 (Device configuration active).

| Byte with value | Bit pattern with value | Notes |
|-----------------|-------------------------|-----------------------------------|
| Byte 1 0xFF | Bit 7 1111-1111 Bit 0 | Bit 0 is true; data is available. |
| Byte 2 0xFF | Bit 15 1111-1111 Bit 8 | |
| Byte 3 0x01 | Bit 23 0000-0001 Bit 16 | |
| Byte 4 0x00 | Bit 31 0000-0000 Bit 24 | |

The devices are configured in addresses 1 (Bit 1) through 16 (Bit 16).

No devices are configured in addresses 1 through 9.

MODE 4 (Device exists) data matches MODE 1 (Device configuration active), so the configured devices match the existing devices.

8.5 Diagnostics (PROFINET or PROFIBUS)

Table 8- 126 Example 2: A module has been pulled from PROFINET slave device "et200s_1". A value of 0x0300_0000 is returned for MODE 2 (Device defective).

| Byte with value | Bit pattern with value | Notes |
|-----------------|-------------------------|-----------------------------------|
| Byte 1 0x03 | Bit 7 0000-0011 Bit 0 | Bit 0 is true; data is available. |
| Byte 2 0x00 | Bit 15 0000-0000 Bit 8 | |
| Byte 3 0x00 | Bit 23 0000-0000 Bit 16 | |
| Byte 4 0x00 | Bit 31 0000-0000 Bit 24 | |

Device 1 (Bit 1) is marked as defective. Since the device still exists, MODE 4 (Device exists) shows the same data as when operating normally.

MODE 5 (Problem in device) returns the same information as MODE 2 (Device defective).

Table 8- 127 Example 2 (continued): A module has been pulled from PROFIBUS slave device "et200s_1". A value of 0xFFFF_0100 is returned for MODE 4 (Device exists).

| Byte with value | Bit pattern with value | Notes |
|-----------------|-------------------------|-----------------------------------|
| Byte 1 0xFF | Bit 7 1111-1111 Bit 0 | Bit 0 is true; data is available. |
| Byte 2 0xFF | Bit 15 1111-1111 Bit 8 | |
| Byte 3 0x01 | Bit 23 0000-0001 Bit 16 | |
| Byte 4 0x00 | Bit 31 0000-0000 Bit 24 | |

Even though device 1 (Bit 1) has an error as shown in MODE 2 (Device defective) above, the device is still functioning on the network which causes MODE 4 (Device exists) to show the device as an "existing device".

Table 8- 128 Example 3: PROFINET slave device "et200s_1" is disconnected (cable disconnected or power loss) from the PROFINET network. A value of 0xFDFF_0100 is returned for MODE 4 (Device exists).

| Byte with value | Bit pattern with value | Notes |
|-----------------|-------------------------|-----------------------------------|
| Byte 1 0xFD | Bit 7 1111-1101 Bit 0 | Bit 0 is true; data is available. |
| Byte 2 0xFF | Bit 15 1111-1111 Bit 8 | |
| Byte 3 0x01 | Bit 23 0000-0001 Bit 16 | |
| Byte 4 0x00 | Bit 31 0000-0000 Bit 24 | |

Device 1 (Bit 1) does not exist. Devices 2 (Bit 2) through 16 (Bit 16) do exist.

8.5.5 ModuleStates instruction

You can use the ModuleStates instruction to return the status of all of the modules in a PROFIBUS or PROFINET station.

Table 8- 129 ModuleStates instruction

| LAD / FBD | SCL | Description |
|---|--|---|
|  | <pre>ret_val := ModuleStates(laddr:=_word_in_, mode:=_uint_in_, state:=_variant_inout);</pre> | <p>ModuleStates retrieves the operational states of I/O modules. After execution, the STATE parameter contains the error state of each I/O module in a bit list (for the assigned LADDR and MODE). This information corresponds with the module status seen in the STEP 7 diagnostics view.</p> <p>The LADDR input of ModuleStates uses is a hardware identifier of a distributed I/O station and not of the head module itself. The hardware identifier can be found by selecting the entire station in the network view and then looking in the hardware identifier section under properties. It can also be found by looking for "Hw_Device" and "Hw_DpSlave" data types in the system constants tab in the PLC tag table.</p> |

Table 8- 130 Data types for the parameters

| Parameter and type | | Data type | Description |
|--------------------|----|-----------|---|
| LADDR | IN | HW_DEVICE | Logical address (Identifier for the I/O modules) |
| MODE | IN | UInt | <p>Supports five modes of operation. The MODE input determines which data will be returned to the location specified for STATE information. The modes are as follows:</p> <ul style="list-style-type: none"> • 1: Module configuration active • 2: Module defective • 3: Module disabled • 4: Module exists • 5: Problem in Module |

| Parameter and type | | Data type | Description |
|--------------------|-------|-----------|---|
| RET_VAL | OUT | Int | Status (condition code) |
| STATE ¹ | InOut | Variant | <p>Buffer that receives the error status of each module: The data type you use for the STATE parameter can be any bit type (Bool, Byte, Word, or DWord) or an array of a bit type.</p> <ul style="list-style-type: none"> • Bit 0 of the first byte of the returned STATE data is a summary bit. When it is set to TRUE, it indicates that other data is available. • The data returned by the STATE parameter shows a one-to-one correlation between a bit location and a module position. This slot addressing is TRUE for PROFIBUS and PROFINET. For example, for an ET 200S with a head module, power module, and a pair of I/O modules, Bit 1 in the first Byte correlates to the head module, Bit 2 to the power module, and Bits 3 and 4 to the I/O modules, respectively. |

¹ A maximum of 128 bits can be assigned. The number of bits required is dependent on your I/O module usage.

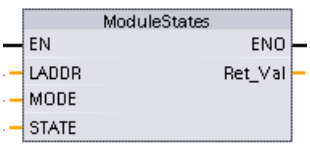
Table 8- 131 Condition codes

| RET_VAL (W#16#...) | Description |
|---------------------|--|
| 0 | No error |
| 8091 | Module identified by LADDR does not exist. |
| 8092 | Module identified by LADDR does not address an I/O device. |
| 8093 | Invalid data type for STATE parameter: Valid data types are (Bool, Byte, Word, or Dword), or an array of (Bools, Bytes, Words, or Dwords). |
| 80Bx | ModuleStates instruction not supported by this CPU for this LADDR. |
| 8452 | The complete state data is too large for the assigned STATE parameter. The STATE buffer contains a partial result. |

8.5.5.1 ModuleStates example configurations

PROFIBUS example

The PROFIBUS example consists of the following:

- 16 PROFIBUS devices named "DPSlave_10" through "DPSlave_25"
- The 16 PROFIBUS devices use PROFIBUS addresses 10 through 25, respectively.
- Each slave device is configured with multiple I/O modules.
- The example uses the LADDR parameter of PROFIBUS slave "DPSlave_12" which contains a head module, a power module, and two I/O modules.
- The first four bytes of the returned STATE parameter information is displayed.

| MODE | Example 1: Normal operation with no errors | Example 2: PROFIBUS slave device DPSlave_12 module pulled | Example 3: PROFIBUS slave device DPSlave_12 disconnected |
|--------------------------------|--|--|---|
| 1: Module configuration active | 0x1F00_0000 | 0x1F00_0000 | 0x1F00_0000 |
| 2: Module defective | 0x0000_0000 | 0x0900_0000 | 0x1F00_0000 |
| 3: Module disabled | 0x0000_0000 | 0x0000_0000 | 0x0000_0000 |
| 4: Module exists | 0x1F00_0000 | 0x1700_0000 | 0x0000_0000 |
| 5: Problem in module | 0x0000_0000 | 0x0900_0000 | 0x1F00_0000 |

The following four tables show a binary breakdown of the four bytes of data that are being analyzed:

Table 8- 132 Example 1: No errors: A value of 0x1F00_0000 is returned for MODE 1 (Module configuration active).

| Byte with value | Bit pattern with value | Notes |
|-----------------|-------------------------|-----------------------------------|
| Byte 1 0x1F | Bit 7 0001-1111 Bit 0 | Bit 0 is true; data is available. |
| Byte 2 0x00 | Bit 15 0000-0000 Bit 8 | |
| Byte 3 0x00 | Bit 23 0000-0000 Bit 16 | |
| Byte 4 0x00 | Bit 31 0000-0000 Bit 24 | |

Slots 1 (Bit 1) through 4 (Bit 4) contain modules. Slots 5 (Bit 5) and beyond do not contain modules.. MODE 4 (Module exists) data matches MODE 1 (Module configuration active), so the configured modules match the existing modules.

Table 8- 133 Example 2: A module has been pulled from PROFIBUS slave device "DPSlave_12". A value of 0x0900_0000 is returned for MODE 2 (Module defective).

| Byte with value | Bit pattern with value | Notes |
|-----------------|-------------------------|-----------------------------------|
| Byte 1 0x09 | Bit 7 0000-1001 Bit 0 | Bit 0 is true; data is available. |
| Byte 2 0x00 | Bit 15 0000-0000 Bit 8 | |
| Byte 3 0x00 | Bit 23 0000-0000 Bit 16 | |
| Byte 4 0x00 | Bit 31 0000-0000 Bit 24 | |

Only module 3 (Bit 3) is marked as defective. All other modules are functional.

8.5 Diagnostics (PROFINET or PROFIBUS)

Table 8- 134 Example 2 (continued): A module has been pulled from PROFIBUS slave device "DPSlave_12". A value of 0x1700_0000 is returned for MODE 4 (Module exists).

| Byte with value | Bit pattern with value | Notes |
|-----------------|-------------------------|-----------------------------------|
| Byte 1 0x17 | Bit 7 0001-0111 Bit 0 | Bit 0 is true; data is available. |
| Byte 2 0x00 | Bit 15 0000-0000 Bit 8 | |
| Byte 3 0x00 | Bit 23 0000-0000 Bit 16 | |
| Byte 4 0x00 | Bit 31 0000-0000 Bit 24 | |

Module 3 (Bit 3) is shown as missing. Modules 1, 2, and 4 (Bits 1, 2, and 4) are shown as existing.

Table 8- 135 Example 3: PROFIBUS slave device "DPSlave_12" is disconnected (cable disconnected or power loss) from the PROFIBUS network. A value of 0x1F00_0000 is returned for MODE 2 (Module defective).

| Byte with value | Bit pattern with value | Notes |
|-----------------|-------------------------|-----------------------------------|
| Byte 1 0x1F | Bit 7 0001-1111 Bit 0 | Bit 0 is true; data is available. |
| Byte 2 0x00 | Bit 15 0000-0000 Bit 8 | |
| Byte 3 0x00 | Bit 23 0000-0000 Bit 16 | |
| Byte 4 0x00 | Bit 31 0000-0000 Bit 24 | |

The modules in slots 1 through 4 (Bits 1 through 4) are all marked as defective since the device is missing.

MODE 5 (Problem in module) shows the same information as MODE 2 (Module defective).

PROFINET example

The PROFINET example consists of the following:

- 16 PROFINET slave devices named "et200s_1" through "et200s_16"
- The 16 PROFINET devices use PROFINET device numbers 1 through 16, respectively.
- Each slave device is configured with multiple I/O modules.
- The example uses PROFINET slave "et200s_1" which contains a head module, a power module, and 18 I/O modules.
- The first four bytes of the returned STATE parameter information is displayed.

| MODE | Example 1: Normal operation with no errors | Example 2: PROFINET et200s_1 slave module pulled | Example 3: PROFINET et200s_1 slave disconnected |
|--------------------------------|--|--|---|
| 1: Module configuration active | 0xFFFF_1F00 | 0xFFFF_1F00 | 0xFFFF_1F00 |
| 2: Module defective | 0x0000_0000 | 0x0180_0000 | 0xFFFF_1F00 |
| 3: Module disabled | 0x0000_0000 | 0x0000_0000 | 0x0000_0000 |
| 4: Module exists | 0xFFFF_1F00 | 0xFF7F_1F00 | 0x0000_0000 |
| 5: Problem in module | 0x0000_0000 | 0x0180_0000 | 0xFFFF_1F00 |

The following four tables show a binary breakdown of the four bytes of data that are being analyzed:

Table 8- 136 Example 1: No errors: A value of 0xFFFF_1F00 is returned for MODE 1 (Module configuration active).

| Byte with value | Bit pattern with value | Notes |
|-----------------|-------------------------|-----------------------------------|
| Byte 1 0xFF | Bit 7 1111-1111 Bit 0 | Bit 0 is true; data is available. |
| Byte 2 0xFF | Bit 15 1111-1111 Bit 8 | |
| Byte 3 0x1F | Bit 23 0001-1111 Bit 16 | |
| Byte 4 0x00 | Bit 31 0000-0000 Bit 24 | |

Slots 1 (Bit 1) through 20 (Bit 20) contain modules. Slot 21 (Bit 21) and beyond do not contain modules..

MODE 4 (Module exists) data matches MODE 1 (Module configuration active), so the configured modules match the existing modules.

Table 8- 137 Example 2: A module has been pulled from PROFINET slave device "et200s_1". A value of 0x0180_0000 is returned for MODE 2 (Module defective).

| Byte with value | Bit pattern with value | Notes |
|-----------------|-------------------------|-----------------------------------|
| Byte 1 0x01 | Bit 7 0000-0001 Bit 0 | Bit 0 is true; data is available. |
| Byte 2 0x80 | Bit 15 1000-0000 Bit 8 | |
| Byte 3 0x00 | Bit 23 0000-0000 Bit 16 | |
| Byte 4 0x00 | Bit 31 0000-0000 Bit 24 | |

Only module 15 (Bit 15) is marked as defective. All other modules are functional.

Table 8- 138 Example 2 (continued): A module has been pulled from PROFIBUS slave device "et200s_1". A value of 0xFF7F_1F00 is returned for MODE 4 (Module exists).

| Byte with value | Bit pattern with value | Notes |
|-----------------|-------------------------|-----------------------------------|
| Byte 1 0xFF | Bit 7 1111-1111 Bit 0 | Bit 0 is true; data is available. |
| Byte 2 0x7F | Bit 15 0111-1111 Bit 8 | |
| Byte 3 0x1F | Bit 23 0001-1111 Bit 16 | |
| Byte 4 0x00 | Bit 31 0000-0000 Bit 24 | |

Module 15 (Bit 15) is shown as missing. Modules 1 through 14 (Bits 1 through 14) and 16 through 20 (Bits 16 through 20) are shown as existing.

8.5 Diagnostics (PROFINET or PROFIBUS)

Table 8- 139 Example 3: PROFINET slave device "et200s_1" is disconnected (cable disconnected or power loss) from the PROFINET network. A value of 0xFFFF_1F00 is returned for MODE 2 (Module defective).

| Byte with value | Bit pattern with value | Notes |
|-----------------|-------------------------|-----------------------------------|
| Byte 1 0xFF | Bit 7 1111-1111 Bit 0 | Bit 0 is true; data is available. |
| Byte 2 0xFF | Bit 15 1111-1111 Bit 8 | |
| Byte 3 0x1F | Bit 23 0001-1111 Bit 16 | |
| Byte 4 0x00 | Bit 31 0000-0000 Bit 24 | |

The modules in slots 1 through 20 (Bits 1 through 20) are all marked as defective since the device is missing.

MODE 5 (Problem in module) shows the same information as MODE 2 (Module defective).

8.5.6 GET_DIAG (Read diagnostic information) instruction

Description

You can use the "GET_DIAG" instruction to read out the diagnostic information of a hardware device. The hardware device is selected with the LADDR parameter. With the MODE parameter, you select which diagnostic information to read.

Table 8- 140 GET_DIAG instruction

| LAD / FBD | SCL | Description |
|-----------|--|---|
| | <pre>ret_val := GET_DIAG(mode:=_uint_in_, laddr:=_word_in_, cnt_diag=>_uint_out_, diag:=_variant_inout_, detail:=_variant_inout_);</pre> | <p>Reads the diagnostic information from an assigned hardware device.</p> |

Parameters

The following table shows the parameters of the "GET_DIAG" instruction:

Table 8- 141 Data types for the parameters

| Parameter and type | | Data type | Description |
|--------------------|-------|---------------|---|
| MODE | IN | UInt | Use the MODE parameter to select which diagnostic data is to be output. |
| LADDR | IN | HW_ANY (Word) | Hardware ID of the device |
| RET_VAL | OUT | Int | Status of the instruction |
| CNT_DIAG | OUT | UInt | Number of output diagnostic details |
| DIAG | InOut | VARIANT | Pointer to data area for storage of diagnostic information of the selected mode |
| DETAILS | InOut | VARIANT | Pointer to data area for storage of diagnostic details in accordance with the selected mode |

MODE parameter

Depending on the value at the MODE parameter, different diagnostics data is output at the DIAG, CNT_DIAG and DETAILS output parameters:

Table 8- 142 MODE parameter

| MODE | Description | DIAG | CNT_DIAG | DETAILS |
|------|---|---|----------|---------|
| 0 | Output of all supported diagnostic information for a module as DWord, where Bit X=1 indicates that mode X is supported. | Bit string of the supported modes as DWord, where Bit X=1 indicates that mode X is supported. | 0 | - |
| 1 | Output of the inherent status of the addressed hardware object. | Diagnostics status: Output in accordance with the DIS structure. (Note: Refer to the "DIS structure" information below and GET_DIAG instruction example at the end of the section.) | 0 | - |
| 2 | Output of the status of all subordinate modules of the addressed hardware object. | Output of diagnostics data in accordance with the DNN structure. (Note: Refer to the "DNN structure" information below and GET_DIAG instruction example at the end of the section.) | 0 | - |

DIS structure

With the MODE parameter = 1, the diagnostics information is output in accordance with the DIS structure. The following table shows the meaning of the individual parameter values:

Table 8- 143 Structure of the Diagnostic Information Source (DIS)

| Parameter | Data type | Value | Description |
|--------------------------|-----------|------------------|--|
| MaintenanceState | DWord | Enum | |
| | | 0 | No maintenance required |
| | | 1 | The module or device is disabled. |
| | | 2 | - |
| | | 3 | - |
| | | 4 | - |
| | | 5 | Maintenance required |
| | | 6 | Maintenance demanded |
| | | 7 | Error |
| | | 8 | Status unknown / error in subordinate module |
| | | 9 | - |
| Componentstate Detail | DWord | Bit array | Status of the module submodules: <ul style="list-style-type: none"> • Bit 0 to 15: Status message of the module • Bit 16 to 31: Status message of the CPU |
| | | 0 to 2 (enum) | Additional information: <ul style="list-style-type: none"> • Bit 0: No additional information • Bit 1: Transfer not permitted |
| | | 3 | Bit 3 = 1: At least one channel supports qualifiers for diagnostics. |
| | | 4 | Bit 4 = 1: Maintenance required for at least one channel or one component |
| | | 5 | Bit 5 = 1: Maintenance demanded for at least one channel or one component |
| | | 6 | Bit 6 = 1: Error in at least one channel or one component |
| | | 7 to 10 | Reserved (always = 0) |
| | | 11 to 14 | Bit 11 = 1: PNIO - submodule correct Bit 12 = 1: PNIO - replacement module Bit 13 = 1: PNIO - incorrect module Bit 14 = 1: PNIO - module disconnected |
| | | 15 | Reserved (always = 0) |

| Parameter | Data type | Value | Description |
|----------------|-----------|-----------|--|
| | | 16 to 31 | Status information for modules generated by the CPU: Bit 16 = 1: Module disabled Bit 17 = 1: CiR operation active Bit 18 = 1: Input not available Bit 19 = 1: Output not available Bit 20 = 1: Overflow diagnostics buffer Bit 21 = 1: Diagnostics not available Bit 22 - 31: Reserved (always 0) |
| OwnState | UInt16 | Enum | The value of the OwnState parameter describes the maintenance status of the module. |
| | | 0 | No fault |
| | | 1 | The module or device is disabled. |
| | | 2 | Maintenance required |
| | | 3 | Maintenance demanded |
| | | 4 | Error |
| | | 5 | The module or the device cannot be reached from the CPU (valid for modules and devices below a CPU). |
| | | 6 | Inputs/outputs are not available. |
| IO State | UInt16 | Bit array | I/O status of the module |
| | | 0 | Bit 0 = 1: No maintenance required |
| | | 1 | Bit 1 = 1: The module or device is disabled. |
| | | 2 | Bit 2 = 1: Maintenance required |
| | | 3 | Bit 3 = 1: Maintenance demanded |
| | | 4 | Bit 4 = 1: Error |
| | | 5 | Bit 5 = 1: The module or the device cannot be reached from the CPU (valid for modules and devices below a CPU). |
| | | 6 | Inputs/outputs are not available. |
| | | 7 | Qualifier; bit 7 = 1, if bit 0, 2, or 3 are set |
| | | 8 to 15 | Reserved (always = 0) |
| OperatingState | UInt16 | Enum | |
| | | 0 | - |
| | | 1 | In STOP / firmware update |
| | | 2 | In STOP / reset memory |
| | | 3 | In STOP / self start |
| | | 4 | In STOP |
| | | 5 | Memory reset |
| | | 6 | In START |
| | | 7 | In RUN |
| | | 8 | - |
| | | 9 | In HOLD |
| | | 10 | - |
| 11 | - | | |

| Parameter | Data type | Value | Description |
|-----------|-----------|-------|-----------------------|
| | | 12 | Module defective |
| | | 13 | - |
| | | 14 | No power |
| | | 15 | CiR |
| | | 16 | In STOP / without DIS |
| | | 17 | In |
| | | 18 | |
| | | 19 | |
| | | 20 | |

DNN structure

With the MODE parameter = 2, the diagnostics information details are output in accordance with the DNN structure. The following table shows the meaning of the individual parameter values:

Table 8- 144 Structure of the Diagnostic Navigation Node (DNN)

| Parameter | Data type | Value | Description |
|--------------------|-----------|----------|--|
| SubordinateState | UINT | Enum | Status of the subordinate module (See parameter OwnState of the DIS structure.) |
| SubordinateIOState | WORD | Bitarray | Status of the inputs and outputs of the subordinate module (See parameter IO State of the DIS structure.) |
| DNNmode | WORD | Bitarray | <ul style="list-style-type: none"> • Bit 0 = 0: Diagnostics enabled • Bit 0 = 1: Diagnostics disabled • Bit 1 to 15: Reserved |

RET_VAL parameter

Table 8- 145 Error codes of the RET_VAL parameter

| Error code (W#16#...) | Description |
|-----------------------|---|
| 0 | No error |
| 8080 | Value in the MODE parameter is not supported. |
| 8081 | Type in the DIAG parameter is not supported with the selected mode (parameter MODE). |
| 8082 | Type in the DETAILS parameter is not supported with the selected mode (parameter MODE). |
| 8090 | LADDR does not exist. |
| 8091 | The selected channel in the CHANNEL parameter does not exist. |
| 80C1 | Insufficient resources for parallel execution |

Example

The following ladder logic network and DB show how to use the three modes with the three structures:

- DIS
- DNN

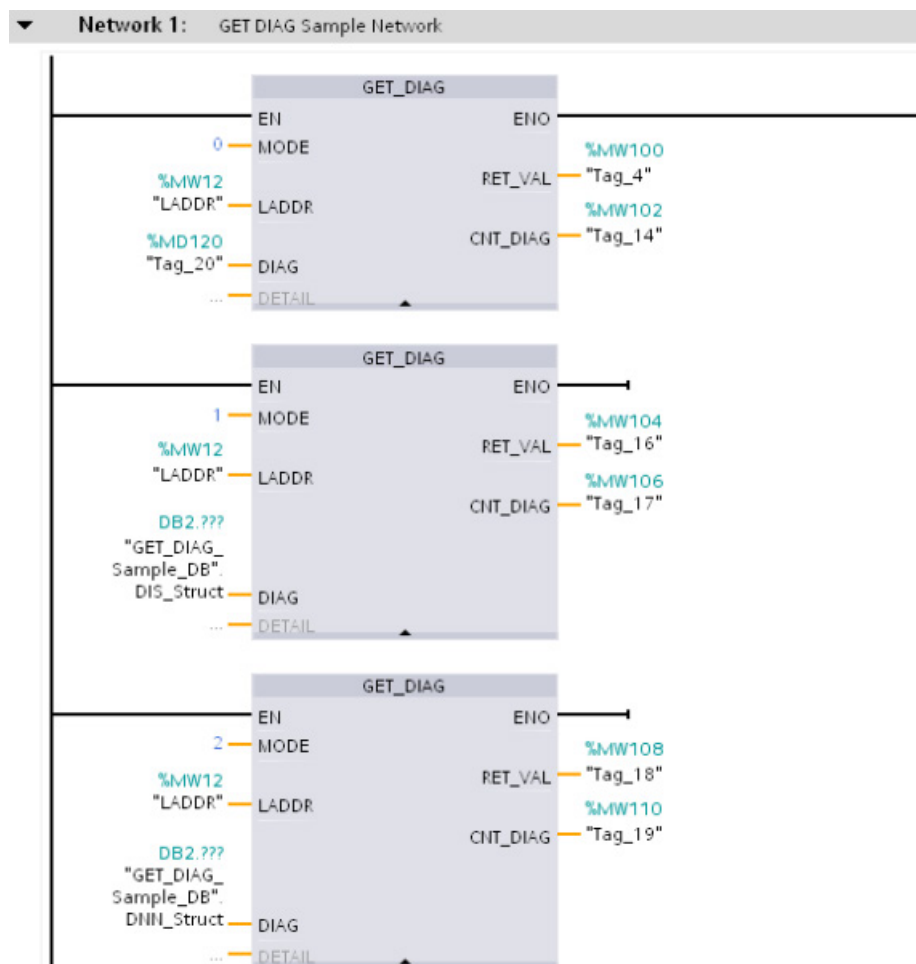

| GET_DIAG_Sample_DB | | | | | | | |
|--------------------|----------------------|-----------|--------|-------------|--------------------------|-------------------------------------|---------|
| | Name | Data type | Offset | Start value | Retain | Visible in HMI | Comment |
| 1 | Static | | | | | | |
| 2 | ▼ DNN_Struct | DNN | 0.0 | | <input type="checkbox"/> | <input checked="" type="checkbox"/> | |
| 3 | SubordinateState | UInt | 0.0 | 0 | <input type="checkbox"/> | <input checked="" type="checkbox"/> | |
| 4 | SubordinateIOState | Word | 2.0 | 0 | <input type="checkbox"/> | <input checked="" type="checkbox"/> | |
| 5 | DNNImode | Word | 4.0 | 0 | <input type="checkbox"/> | <input checked="" type="checkbox"/> | |
| 6 | ▼ DIS_Struct | DIS | 6.0 | | <input type="checkbox"/> | <input checked="" type="checkbox"/> | |
| 7 | MaintenanceState | DWord | 0.0 | 0 | <input type="checkbox"/> | <input checked="" type="checkbox"/> | |
| 8 | ComponentStateDetail | DWord | 4.0 | 0 | <input type="checkbox"/> | <input checked="" type="checkbox"/> | |
| 9 | OwnState | UInt | 8.0 | 0 | <input type="checkbox"/> | <input checked="" type="checkbox"/> | |
| 10 | IOState | Word | 10.0 | 0 | <input type="checkbox"/> | <input checked="" type="checkbox"/> | |
| 11 | OperatingState | UInt | 12.0 | 0 | <input type="checkbox"/> | <input checked="" type="checkbox"/> | |

- ① DNN
② DIS

Note

In the DB, you must manually type in the data type to access each of the three structures; there is no dropdown list selection. Type in the data types exactly as shown below:

- DNN
- DIS

8.6 Pulse

8.6.1 CTRL_PWM (Pulse width modulation) instruction

Table 8- 146 CTRL_PWM (Pulse Width Modulation) instruction

| LAD / FBD | SCL | Description |
|-----------|--|--|
| | <pre>"CTRL_PWM_DB" (PWM:=_word_in_, enable:=_bool_in_, busy=>_bool_out_, status=>_word_out_);</pre> | <p>Provides a fixed cycle time output with a variable duty cycle. The PWM output runs continuously after being started at the specified frequency (cycle time). The pulse width is varied as required to affect the desired control.</p> |

- 1 STEP 7 automatically creates the DB when you insert the instruction.
- 2 In the SCL example, "CTRL_PWM_DB" is the name of the instance DB.

Table 8- 147 Data types for the parameters

| Parameter and type | Data type | Description |
|--------------------|---------------|--|
| PWM IN | HW_PWM (Word) | PWM identifier: Names of enabled pulse generators will become tags in the "constant" tag table, and will be available for use as the PWM parameter. (Default value: 0) |
| ENABLE IN | Bool | 1=start pulse generator 0 = stop pulse generator |
| BUSY OUT | Bool | Function busy (Default value: 0) |
| STATUS OUT | Word | Execution condition code (Default value: 0) |

The CTRL_PWM instruction stores the parameter information in the DB. The data block parameters are not separately changed by the user, but are controlled by the CTRL_PWM instruction.

Specify the enabled pulse generator to use, by using its tag name for the PWM parameter.

When the EN input is TRUE, the PWM_CTRL instruction starts or stops the identified PWM based on the value at the ENABLE input. Pulse width is specified by the value in the associated Q word output address.

Because the CPU processes the request when the CTRL_PWM instruction is executed, parameter BUSY will always report FALSE. If an error is detected, then ENO is set to FALSE, and parameter STATUS contains a condition code.

The pulse width will be set to the initial value configured in device configuration when the CPU first enters RUN mode. You write values to the Q-word location specified in device configuration ("Output addresses" / "Start address:") as needed to change the pulse width. You use an instruction such as a move, convert, math, or PID box to write the desired pulse width to the appropriate Q word. You must use the valid range for the Q-word value (percent, thousandths, ten-thousandths, or S7 analog format).

Note

Digital I/O points assigned to PWM and PTO cannot be forced

The digital I/O points used by the pulse-width modulation (PWM) and pulse-train output (PTO) devices are assigned during device configuration. When digital I/O point addresses are assigned to these devices, the values of the assigned I/O point addresses cannot be modified by the Watch table force function.

Table 8- 148 Value of the STATUS parameter

| STATUS | Description |
|--------|--|
| 0 | No error |
| 80A1 | PWM identifier does not address a valid PWM. |

8.6.2 Operation of the pulse outputs



- ① Cycle time
- ② Pulse width

Pulse width can be expressed as hundredths of the cycle time (0 to 100), as thousandths (0 to 1000), as ten thousandths (0 to 10000), or as S7 analog format.

The pulse width can vary from 0 (no pulse, always off) to full scale (no pulse, always on).

Since the PWM output can be varied from 0 to full scale, it provides a digital output that in many ways is the same as an analog output. For example, the PWM output can be used to control the speed of a motor from stop to full speed, or it can be used to control position of a valve from closed to fully opened.

Four pulse generators are available for controlling high-speed pulse output functions: PWM and Pulse train output (PTO). PTO is used by the motion control instructions. You can assign each pulse generator to either PWM or PTO, but not both at the same time.

You can use onboard CPU outputs, or you can use the optional signal board outputs. The output point numbers are shown in the following table (assuming the default output configuration). If you have changed the output point numbering, then the output point numbers will be those you assigned. Note that PWM requires only one output, while PTO can optionally use two outputs per channel. If an output is not required for a pulse function, it is available for other uses. Refer to the table below for I/O assignment.

The table below shows the default I/O assignments; however, the four pulse generators can be configured to any CPU built-in or SB digital output. Different output points support different voltages and speeds, so take that into account when assigning PWM/PTO locations.

Note

Pulse-train outputs cannot be used by other instructions in the user program.

When you configure the outputs of the CPU or signal board as pulse generators (for use with the PWM or motion control PTO instructions), the corresponding outputs addresses are removed from the Q memory and cannot be used for other purposes in your user program. If your user program writes a value to an output used as a pulse generator, the CPU does not write that value to the physical output.

Note

PTO direction outputs can be freed for use elsewhere in your program.

Each PTO requires the assignment of two outputs: one as a pulse output and one as a direction output. You can use just the pulse output and not the direction output. You can then free the direction output for other purposes in your user program.

Table 8- 149 Default output assignments for the pulse generators³

| Description | Pulse | Direction |
|------------------|-------------------|-------------------|
| PTO1 | | |
| Built-in I/O | Q0.0 | Q0.1 |
| SB I/O | Q4.0 | Q4.1 |
| PWM1 | | |
| Built-in outputs | Q0.0 | - |
| SB outputs | Q4.0 | - |
| PTO2 | | |
| Built-in I/O | Q0.2 | Q0.3 |
| SB I/O | Q4.2 | Q4.3 |
| PWM2 | | |
| Built-in outputs | Q0.2 | - |
| SB outputs | Q4.2 | - |
| PTO3 | | |
| Built-in I/O | Q0.4 ¹ | Q0.5 ¹ |
| SB I/O | Q4.0 | Q4.1 |

| Description | Pulse | Direction |
|------------------|-------------------|-------------------|
| PWM3 | | |
| Built-in outputs | Q0.4 ¹ | - |
| SB outputs | Q4.1 | - |
| PTO4 | | |
| Built-in I/O | Q0.6 ² | Q0.7 ² |
| SB I/O | Q4.2 | Q4.3 |
| PWM4 | | |
| Built-in outputs | Q0.6 ² | - |
| SB outputs | Q4.3 | - |

- ¹ The CPU 1211C does not have outputs Q0.4, Q0.5, Q0.6, or Q0.7. Therefore, these outputs cannot be used in the CPU 1211C.
- ² The CPU 1212C does not have outputs Q0.6 or Q0.7. Therefore, these outputs cannot be used in the CPU 1212C.
- ³ This table applies to the CPU 1211C, CPU 1212C, CPU 1214C, CPU 1215C, and CPU 1217C PTO/PWM functions.

8.6.3 Configuring a pulse channel for PWM

To prepare for PWM operation, first configure a pulse channel in the device configuration by selecting the CPU, then Pulse Generator (PTO/PWM), and choose PWM1 through PWM4. Enable the pulse generator (check box). If a pulse generator is enabled, a unique default name is assigned to this particular pulse generator. You can change this name by editing it in the "Name:" edit box, but it must be a unique name. Names of enabled pulse generators will become tags in the "constant" tag table, and will be available for use as the PWM parameter of the CTRL_PWM instruction.

Table 8- 150 CPU output: maximum frequency

| CPU | CPU output channel | Pulse and direction output | A/B, quadrature, up/down, and pulse/direction |
|-----------------|--|----------------------------|---|
| 1211C | Qa.0 to Qa.3 | 100 kHz | 100 kHz |
| 1212C | Qa.0 to Qa.3 | 100 kHz | 100 kHz |
| | Qa.4, Qa.5 | 20 kHz | 20 kHz |
| 1214C and 1215C | Qa.0 to Qa.4 | 100kHz | 100kHz |
| | Qa.5 to Qb.1 | 20 kHz | 20 kHz |
| 1217C | DQa.0 to DQa.3 (.0+, .0- to .3+, .3-) | 1 MHz | 1 MHz |
| | DQa.4 to DQb.1 | 100 kHz | 100 kHz |

Table 8- 151 SB signal board output: maximum frequency (optional board)

| SB signal board | SB output channel | Pulse and direction output | A/B, quadrature, up/down, and pulse/direction |
|------------------|-------------------|----------------------------|---|
| SB 1222, 200 kHz | DQe.0 to DQe.3 | 200kHz | 200 kHz |
| SB 1223, 200 kHz | DQe.0, DQe.1 | 200kHz | 200 kHz |
| SB 1223 | DQe.0, DQe.1 | 20 kHz | 20 kHz |

Note

The maximum pulse frequency of the pulse output generators is 1 MHz for the CPU 1217C and 100 KHz for CPUs 1211C, 1212C, 1214C, and 1215C; 20 KHz (for a standard SB); or 200 KHz (for a high-speed SB). However, STEP 7 does not alert you when you configure an axis with a maximum speed or frequency that exceeds this hardware limitation. Problems can result with your application, so always ensure that you do not exceed the maximum pulse frequency of the hardware.

You have the option to rename the pulse generator, add a comment, and assign parameters as follows:

- Pulse generator used as follows: PWM or PTO (choose PWM)
- Output source: onboard CPU or SB
- Time base: milliseconds or microseconds
- Pulse width format:
 - Hundredths (0 to 100)
 - Thousandths (0 to 1000)
 - Ten-thousandths (0 to 10000)
 - S7 analog format (0 to 27648)
- Cycle time (range is 0 to 16,777,215): Enter your cycle time value. This value can only be changed in Device configuration.
- Initial pulse width: Enter your initial pulse width value. The pulse width value can be changed during runtime.

Enter the start address to configure the output addresses. Enter the Q word address where you want to locate the pulse width value.

Note

Pulse-train outputs cannot be used by other instructions in the user program

When you configure the outputs of the CPU or signal board as pulse generators (for use with the PWM or motion control instructions), the corresponding outputs addresses are removed from the Q memory and cannot be used for other purposes in your user program. If your user program writes a value to an output used as a pulse generator, the CPU does not write that value to the physical output.

The default locations for the pulse width values are as follows:

- PWM1: QW1000
- PWM2: QW1002
- PWM3: QW1004
- PWM4: QW1006

The value at this location controls the width of the pulse and is initialized to the "Initial pulse width:" value specified above each time the CPU transitions from STOP to RUN mode. You change this Q-word value during run time to cause a change in the pulse width.

8.7 Recipes and Data logs

8.7.1 Recipes

8.7.1.1 Recipe overview

Recipe data storage

- A recipe data block that you create in your project must be stored in CPU **load** memory. Internal CPU memory or an external memory "Program" card can be used.
- Another DB that you must create is the active recipe data block. This DB must be in **work** memory, where one active recipe record is read or written with your program logic.

Recipe data management

The recipe DB uses an array of product recipe records. Each element of the recipe array represents a different recipe flavor that is based on a common set of components.

- You create a PLC data type or struct that defines all the components in one recipe record. This data type template is reused for all recipe records. Product recipes vary according to the start values that are assigned to the recipe components.
- One of the recipes can be transferred at any time from the recipe DB (all recipes in load memory) to the active recipe DB (one recipe in work memory) using the READ_DBL instruction. After a recipe record is moved to work memory, then your program logic can read the component values and begin a production run. This transfer minimizes the amount of CPU work memory that is required for recipe data.
- If the active recipe component values are adjusted by an HMI device during a production run, you can write the modified values back to the recipe DB, using the WRIT_DBL instruction.

Recipe export (from recipe DB to CSV file)

The complete set of recipe records can be generated as a CSV file using the RecipeExport instruction. Unused recipe records are also exported.

Recipe import (from CSV file to recipe DB)

Once a recipe export operation is completed, then you can use the generated CSV file as a data structure template.

1. Use the file browser page in the CPU web server to download an existing recipe CSV file from the CPU to a PC
2. Modify the recipe CSV with an ASCII text editor. You can modify the start values assigned to components, but not the data types or data structure
3. Upload the modified CSV file from PC back to the CPU. However, the old CSV file in CPU load memory (with the same name) must be deleted or renamed before the CPU Web server allows the upload operation.
4. After the modified CSV file is uploaded to the CPU, then you can use the RecipeImport instruction to transfer the new start values from the modified CSV file (in CPU load memory) to the recipe DB (in CPU load memory).

8.7.1.2 Recipe DB example

Example recipes

The table below shows how to prepare recipe information for use in a recipe DB. The example recipe DB stores five records, three of which are used. The fourth and fifth records are free for later expansions. Each table row represents one record that stores the recipe name, component data types, and component values.

| productname | water | barley | wheat | hops | yeast | waterTmp | mashTmp | mashTime | QTest |
|-------------|-------|--------|-------|------|-------|----------|---------|----------|-------|
| Pils | 10 | 9 | 3 | 280 | 39 | 40 | 30 | 100 | 0 |
| Lager | 10 | 9 | 3 | 150 | 33 | 50 | 30 | 120 | 0 |
| BlackBeer | 10 | 9 | 3 | 410 | 47 | 60 | 30 | 90 | 1 |
| Not_used | 0 | 0 | 0 | 0 | 0 | 0 | 0 | 0 | 0 |
| Not_used | 0 | 0 | 0 | 0 | 0 | 0 | 0 | 0 | 0 |

Creating a recipe data block

Note

Rules for recipe data blocks

- The recipe DB must contain a single dimension array of either a PLC data type or a struct. The recipe example shows how to create a recipe DB with a PLC data type.
- In the example, the data type of the component ingredients are all the UInt data type. The component data types may also be a mix of any data type except for structs. In a recipe DB array element, a struct in a PLC data type or a struct in a struct is not allowed.

First, create a new PLC data type

Add a new PLC data type whose name is the recipe type. In the following image, "Beer_Recipe" is the new complex PLC data type that stores a sequence of simple data types. The "Beer_Recipe" PLC data type is a data template that is reused in each recipe DB record and also in the active recipe DB. Enter the component names and data types that are common to all the example recipes. The individual component values are added later in the recipe DB.

| Beer_Recipe | | | |
|-------------|-------------|------------|---------------|
| | Name | Data type | Default value |
| 1 | productname | String[20] | 'Beer_Recipe' |
| 2 | water | UInt | 0 |
| 3 | barley | UInt | 0 |
| 4 | wheat | UInt | 0 |
| 5 | hops | UInt | 0 |
| 6 | yeast | UInt | 0 |
| 7 | waterTmp | UInt | 0 |
| 8 | mashTmp | UInt | 0 |
| 9 | mashTime | UInt | 0 |
| 10 | QTest | UInt | 0 |

Second, create a recipe data block

- Create your recipe DB as a global data block with the DB property "Only store in load memory" enabled.
- The name of a recipe data block is used as file name of the corresponding CSV file. The DB name characters you assign must follow the Windows file system naming restrictions. Characters \ / : * ? " < > | and the space character are not allowed.
- The recipe array assignment is "Products" as Array [1.. 5] of "Beer_Recipe". The array size 5 is the maximum number of recipe flavors that are possible.
- The values for recipe components are added as DB start values.

In the following image, the "BlackBeer" recipe is expanded to show all the components of a recipe record.

| Recipe_DB | | | | |
|-----------|-------------|---------------------------------|--------|-------------|
| | Name | Data type | Offset | Start value |
| 1 | Static | | | |
| 2 | Products | Array [1 .. 5] of "Beer_Recipe" | ... | |
| 3 | Products[1] | "Beer_Recipe" | ... | |
| 4 | Products[2] | "Beer_Recipe" | ... | |
| 5 | Products[3] | "Beer_Recipe" | ... | |
| 6 | productname | String[20] | ... | 'BlackBeer' |
| 7 | water | UInt | ... | 10 |
| 8 | barley | UInt | ... | 9 |
| 9 | wheat | UInt | ... | 3 |
| 10 | hops | UInt | ... | 410 |
| 11 | yeast | UInt | ... | 47 |
| 12 | waterTmp | UInt | ... | 60 |
| 13 | mashTmp | UInt | ... | 30 |
| 14 | mashTime | UInt | ... | 90 |
| 15 | QTest | UInt | ... | 1 |
| 16 | Products[4] | "Beer_Recipe" | ... | |
| 17 | Products[5] | "Beer_Recipe" | ... | |

Recipe export (from recipe DB to CSV file)

"RecipeExport (Page 374)" execution transfers recipe DB data to a CSV file, as shown in the following text file.

```
Recipe_DB.csv
index,productname,water,barley,wheat,hops,yeast,waterTmp,
mashTmp,mashTime,QTest
1,"Pils",10,9,3,280,39,40,30,100,0
2,"Lager",10,9,3,150,33,50,30,120,0
3,"BlackBeer",10,9,3,410,47,60,30,90,1
4 "Not_used",0,0,0,0,0,0,0,0,0,0
5 "Not_used",0,0,0,0,0,0,0,0,0,0
```

Recipe import (from CSV file to recipe DB)

1. Use the file browser page in the CPU web server to download an existing recipe CSV file from CPU load memory to a PC
2. Modify the recipe CSV with an ASCII text editor. You can modify the start values assigned to components, but not the data types or data structure
3. Upload the modified CSV file from PC back to the CPU. However, the old CSV file in CPU load memory (with the same name) must be deleted or renamed before the CPU Web server allows the upload operation.
4. After the modified CSV file is uploaded to the CPU, then you can use the RecipelImport instruction to transfer the new start values from the modified CSV file (in CPU load memory) to the recipe DB (in CPU load memory).

CSV files must exactly match the corresponding recipe DB structure

- The values in the CSV file can be changed, but changing the structure is not allowed. The RecipelImport instruction requires that the exact number of records and components matches the destination recipe DB structure. Otherwise, RecipelImport execution fails. For example, if 10 recipes are defined in the recipe DB but only 6 are in use, then line 7 to 10 in the CSV file are also transferred to the DB. You must coordinate whether this data is valid or not. For example, you can assign a variable "Not_used" for the product name in unused recipe records.
- If you add data records to the text file and import the modified file, make sure the recipe DB array limit you assign has enough elements for all the recipe records.
- An index number is automatically generated during export to the CSV file. If you create additional data records, add consecutive index numbers accordingly.
- RecipelImport execution checks the CSV file data for correct structure and whether the values fit in the data types assigned in the associated recipe DB. For example, a Bool data type cannot store an integer value and the RecipelImport execution fails.

Display CSV recipe data in Excel

The CSV file can be opened in Excel to make reading and editing easier. If the commas are not recognized as decimal separators, use the Excel import function to output the data in structured form

| | A | B | C | D | E | F | G | H | I | J | K |
|---|-------|-------------|-------|--------|-------|------|-------|----------|---------|----------|-------|
| 1 | index | product | water | barley | wheat | hops | yeast | waterTmp | mashTmp | mashTime | QTest |
| 2 | 1 | "Pils" | 10 | 9 | 3 | 280 | 39 | 40 | 30 | 100 | 0 |
| 3 | 2 | "Lager" | 10 | 9 | 3 | 150 | 33 | 50 | 30 | 120 | 0 |
| 4 | 3 | "BlackBeer" | 10 | 9 | 3 | 410 | 47 | 60 | 30 | 90 | 1 |
| 5 | 4 | "Not_used" | 0 | 0 | 0 | 0 | 0 | 0 | 0 | 0 | 0 |
| 6 | 5 | "Not_used" | 0 | 0 | 0 | 0 | 0 | 0 | 0 | 0 | 0 |

8.7.1.3 Program instructions that transfer recipe data

RecipeExport (Recipe export) instruction

Table 8- 152 RecipeExport instruction

| LAD/FBD | SCL | Description |
|---------|--|---|
| | <pre>"RecipeExport_DB" (req=_bool_in_, done=>_bool_out_, busy=>_bool_out_, error=>_bool_out_, status=>_word_out_, Recipe_DB:=_variant_inout_);</pre> | <p>The "RecipeExport" instruction exports all recipe records from a recipe data block to the CSV file format. The CSV file contains product names, component names, and start values. The CSV file is stored in internal load memory or external load memory, if an optional external "program" memory card is installed.</p> <p>The export operation is triggered by the "REQ" parameter. The BUSY parameter is set to "1" during export processing. After the execution of RecipeExport stops, BUSY is reset to "0" and the completion of the operation is indicated with "1" at the DONE parameter. If an error occurs during execution, then parameters ERROR and STATUS indicate the result.</p> |

A recipe DB must be created before a recipe export is possible. The name of a recipe data block is used as file name of the new CSV file. If a CSV file with an identical name already exists, then it is overwritten during the export operation.

You can use the File Browser page (Page 622) of the CPU's built-in Web server to access the recipe CSV file. The file is put in the recipe folder in the root directory of CPU load memory.

Table 8- 153 Data types for the parameters

| Parameter and type | | Data type | Description |
|--------------------|--------|-----------|--|
| REQ | IN | Bool | Control parameter REQUEST: Activates the export on a positive edge. |
| RECIPE_DB | In/Out | Variant | Pointer to the recipe data block. Refer to the "Recipe DB example (Page 370)" for details. The DB name characters must follow the Windows file system naming restrictions. Characters \ / : * ? " < > and the space character are not allowed. |
| DONE | OUT | Bool | The DONE bit is TRUE for one scan, after the last request was completed with no error. (Default value: False) |
| BUSY | OUT | Bool | RecipeExport execution <ul style="list-style-type: none"> • 0: No operation in progress • 1: Operation on progress |

| Parameter and type | | Data type | Description |
|--------------------|-----|-----------|---|
| ERROR | OUT | Bool | <p>The ERROR bit is TRUE for one scan, after the last request was terminated with an error. The error code value at the STATUS parameter is valid only during the single scan where ERROR = TRUE.</p> <ul style="list-style-type: none"> • 0: No warning or error • 1: An error has occurred. The STATUS parameter provides information on the type of error. |
| STATUS | OUT | Word | Execution condition code |

Table 8- 154 Values of ERROR and STATUS

| ERROR | STATUS (W#16#...) | Description |
|-------|-------------------|---|
| 0 | 0000 | No error |
| 0 | 7000 | Call with no REQ edge: BUSY = 0, DONE = 0 |
| 0 | 7001 | First call with REQ edge (working): BUSY = 1, DONE = 0 |
| 0 | 7002 | N th call (working): BUSY = 1, DONE = 0 |
| 1 | 8070 | All instance memory is in use. |
| 1 | 8090 | File name contains invalid characters |
| 1 | 8091 | The data structure referenced with RECIPE_DB cannot be processed. |
| 1 | 8092 | Data structure specified in RECIPE_DB exceeds 5000 bytes |
| 1 | 80B3 | Not enough space in on MC or in internal load memory |
| 1 | 80B4 | MC is write protected |
| 1 | 80B6 | Recipe DB attribute "Only store in load memory" is not enabled. |
| 1 | 80C0 | CSV file is temporarily locked |
| 1 | 80C1 | DB is temporarily locked |

RecipeImport (Recipe import) instruction

Table 8- 155 RecipeImport instruction

| LAD/FBD | SCL | Description |
|---------|---|--|
| | <pre>"RecipeImport_DB" (req:=_bool_in_, done=>_bool_out_, busy=>_bool_out_, error=>_bool_out_, status=>_word_out_, Recipe_DB:=_variant_inout_);</pre> | <p>The "RecipeImport" instruction imports recipe data from a CSV file, in CPU load memory, to a recipe data block referenced by the RECIPE_DB parameter. Start values in the recipe data block are overwritten by the import process. The import operation is triggered by the "REQ" parameter. The BUSY parameter is set to "1" during import processing. After the execution of RecipeImport stops, BUSY is reset to "0" and the completion of the operation is indicated with "1" at the DONE parameter. If an error occurs during execution, then parameters ERROR and STATUS indicate the result.</p> |

Table 8- 156 Data types for the parameters

| Parameter and type | Data type | Description | |
|--------------------|-----------|-------------|--|
| REQ | IN | Bool | Control parameter REQUEST: Activates the import on a positive edge. |
| RECIPE_DB | In/Out | Variant | Pointer to the recipe data block. Refer to "Recipe DB example (Page 370)" for details. The DB name characters must follow the Windows file system naming restrictions. Characters \ / : * ? " < > and the space character are not allowed. |
| DONE | OUT | Bool | The DONE bit is TRUE for one scan, after the last request was completed with no error. (Default value: False) |
| BUSY | OUT | Bool | <ul style="list-style-type: none"> 0 - No operation in progress 1 - Operation on progress |
| ERROR | OUT | Bool | The ERROR bit is TRUE for one scan, after the last request was terminated with an error. The error code value at the STATUS parameter is valid only during the single scan where ERROR = TRUE. |
| STATUS | OUT | Word | Execution condition code (Default value: 0) |

A recipe DB that contains a structure which is consistent with the CSV file data structure must exist, before a recipe import operation is possible.

CSV file rules:

- The CSV file must be located in the root directory "Recipes" folder of internal load memory or external load memory, if an optional external "program" memory card is installed.
- The name of the CSV file must match the name of the data block at the RECIPE_DB parameter.
- The first line (header) of the CSV file contains the name of the recipe components. The first line is ignored during import. The names of the recipe components in the CSV file and the data block are not reconciled during the import process.
- In each case the first value in each line of the CSV file is the index number of the recipe. The individual recipes are imported in the order of the index. For this, the index in the CSV file has to be in ascending order and may contain no gaps (if this is not the case, the error message 80B0 is output at the STATUS parameter).
- The CSV file may not contain more recipe data records than provided for in the recipe data block. The maximum number of data records is indicated by the array limits in the data block.

Table 8- 157 Values of ERROR and STATUS

| ERROR | STATUS (W#16#....) | Description |
|-------|--------------------|--|
| 0 | 0000 | No error |
| 0 | 7000 | Call with no REQ edge: BUSY = 0, DONE = 0 |
| 0 | 7001 | First call with REQ edge (working): BUSY = 1, DONE = 0 |
| 0 | 7002 | N th call (working): BUSY = 1, DONE = 0 |
| 1 | 8070 | All instance memory is in use. |
| 1 | 8090 | The file name contains invalid characters. |
| 1 | 8092 | No matching CSV file found for the import. Possible cause: The name of the CSV file does not match the name of the recipe DB. |
| 1 | 80C0 | CSV file is temporarily locked. |
| 1 | 80C1 | Data block is temporarily locked. |
| 1 | 80B0 | Numbering in the index of the CSV file is not continuous, not ascending or exceeds the maximum number (array limit) in the data block. |
| 1 | 80B1 | Structure of the recipe data block and the CSV file do not match: The CSV file contains too many fields. |
| 1 | 80B2 | Structure of the recipe data block and the CSV file do not match: The CSV file contains too few fields. |
| 1 | 80B6 | Recipe DB attribute "Only store in load memory" is not enabled. |
| 1 | 80D0 +n | Structure of the recipe data block and the CSV file do not match: Data type in field n does not match (n<=46). |
| 1 | 80FF | Structure of the recipe data block and the CSV file do not match: Data type in field n does not match (n>46). |

8.7.1.4 Recipe example program

Prerequisites for the recipe example program

- A recipe DB that stores all recipe records. The recipe DB is stored in load memory.
- An active recipe DB that stores a copy of one recipe in work memory.

Refer to the "Recipe DB example (Page 370)" for details about the recipe DB and the corresponding CSV file.

Create the active recipe DB

On the "Add new block" window:

- Select the "Data block" button on the "Add new block" window
- On the "Type" drop-down menu, select the "Beer_recipe" PLC data type that you created previously.

Start values are not required. The DB data values are set when one recipe is transferred from the recipe DB to the active recipe DB. In the example, the active recipe DB is the destination for READ_DBL data and provides source data for WRITE_DBL. The following image shows the Active_Recipe DB.

| Active_Recipe | | | |
|---------------|-------------|------------|---------------|
| | Name | Data type | Start value |
| 1 | Static | | |
| 2 | productname | String[20] | 'Beer_Recipe' |
| 3 | water | UInt | 0 |
| 4 | barley | UInt | 0 |
| 5 | wheat | UInt | 0 |
| 6 | hops | UInt | 0 |
| 7 | yeast | UInt | 0 |
| 8 | waterTmp | UInt | 0 |
| 9 | mashTmp | UInt | 0 |
| 10 | mashTime | UInt | 0 |
| 11 | QTest | UInt | 0 |

Instance DBs

The instance DBs used by instructions RecipeExport ("RecipeExport_DB") and RecipeImport ("RecipeImport_DB") are created automatically when you place the instructions in your program. The instance DBs are used to control instruction execution and are not referenced in the program logic.

Example recipe program

Network 1 A rising edge on REQ starts the export process. A CSV file is generated from the recipe DB data and placed in the CPU memory recipes folder.

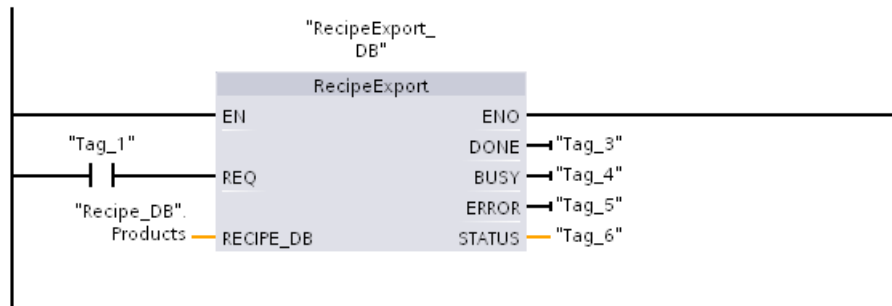

Network 2 Capture the STATUS output from RecipeExport execution, because it is only valid for one scan.

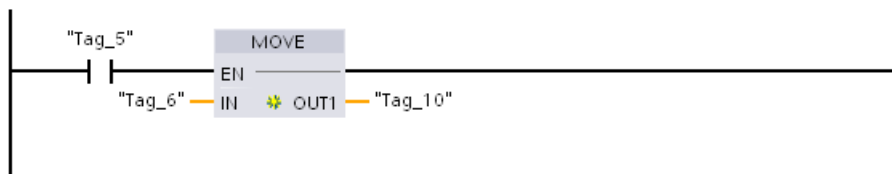

Network 3 A rising edge on REQ starts the import process. The existing recipe DB is loaded with all recipe data read from the corresponding CSV file that is located in the CPU memory recipes folder.

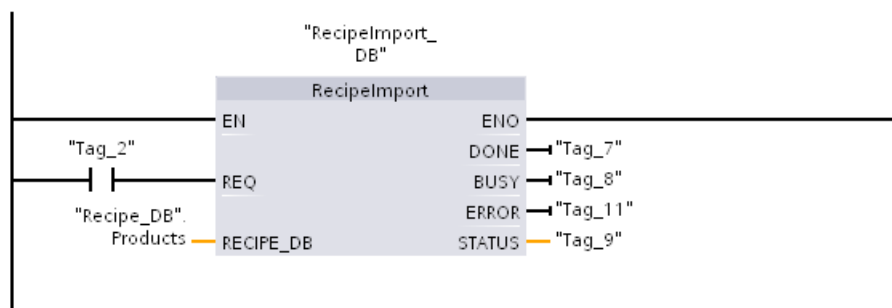

Network 4 Capture the STATUS output from RecipeImport execution, because it is only valid for one scan.

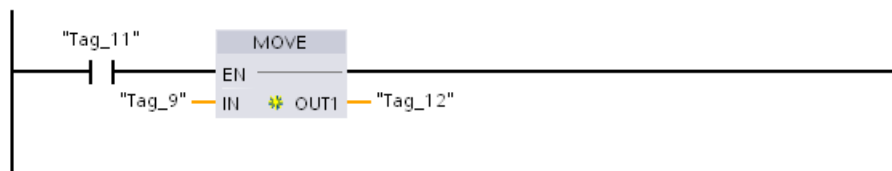

Network 5 READ_DBL copies the start values from one recipe "Recipe_DB".Products[1] (in CPU load memory) to the Active_Recipe DB current values (in CPU work memory). After READ_DBL execution, your program logic can access the recipe component values by addressing locations in the Active_Recipe DB. For example, the symbolic addresses ("Active_Recipe".productname) and ("Active_Recipe.water) provide your program logic with the current recipe name and quantity of water.

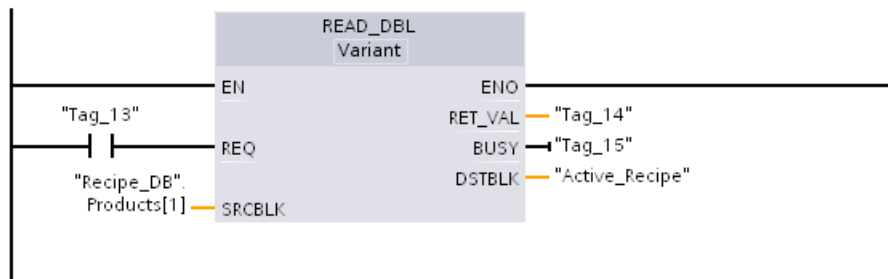

Network 6 During run time, An HMI device could modify a component value stored in the Active_Recipe DB. Improved recipe data can be stored by executing WRIT_DBL. In the example, all Recipe_DB start values for the single recipe "Recipe_DB".Products[1] are overwritten by the current values from the "Active_Recipe" DB.

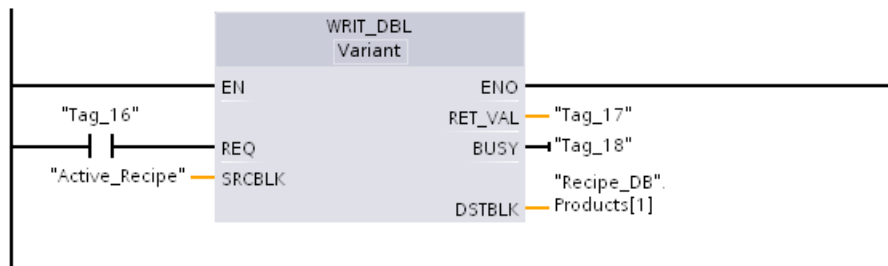

8.7.2 Data logs

Your control program can use the Data log instructions to store run-time data values in persistent log files. The data log files are stored in flash memory (CPU or memory card). Log file data is stored in standard CSV (Comma Separated Value) format. The data records are organized as a circular log file of a pre-determined size.

The Data log instructions are used in your program to create, open, write a record, and close the log files. You decide which program values will be logged by creating a data buffer that defines a single log record. Your data buffer is used as temporary storage for a new log record. New current values must be programmatically moved into the buffer during run-time. When all of the current data values are updated, you can execute the DataLogWrite instruction to transfer data from the buffer to a data log record.

You can open, edit, save, rename, and delete data log files from the File Browser page of the Web Server. You must have read privileges to view the file browser and you must have modify privileges to edit, delete, or rename data log files.

8.7.2.1 Data log record structure

The DATA and HEADER parameters of the DataLogCreate instruction assign the data type and the column header description of all data elements in a log record.

DATA parameter for the DataLogCreate instruction

The DATA parameter points to memory used as a temporary buffer for a new log record and must be assigned to an M or DB location.

You can assign an entire DB (derived from a PLC data type that you assign when the DB is created) or part of a DB (the specified DB element can be any data type, data type structure, PLC data type, or data array).

Structure data types are limited to a single nesting level. The total number of data elements declared should correspond to the number of columns specified in the header parameter. The maximum number of data elements you can assign is 253 (with a timestamp) or 255 (without a timestamp). This restriction keeps your record inside the 256 column limit of an Excel sheet.

The DATA parameter can assign either retentive or non-retentive data elements in a "Standard" (compatible with S7-300/400) or "Optimized" DB type.

In order to write a Data log record you must first load the temporary DATA record with new process values and then execute the DataLogWrite instruction that saves new record values in the Datalog file.

HEADER parameter for the DataLogCreate instruction

The HEADER parameter points to column header names for the top row of the data matrix encoded in the CSV file. HEADER data must be located in DB or M memory and the characters must follow standard CSV format rules with commas separating each column name. The data type may be a string, byte array, or character array. Character/byte arrays allow increased size, where strings are limited to a maximum of 255 bytes. The HEADER parameter is optional. If the HEADER is not assigned, then no header row is created in the Data log file.

8.7.2.2 Program instructions that control data logs

DataLogCreate (Create data log) instruction

Table 8- 158 DataLogCreate instruction

| LAD/FBD | SCL | Description |
|---------|--|--|
| | <pre>"DataLogCreate_DB" (req:=_bool_in_, records:=_udint_in_, format:=_uint_in_, timestamp:=_uint_in_, done=>_bool_out_, busy=>_bool_out_, error=>_bool_out_, status=>_word_out_, name:=_string_inout_, ID:=_dword_inout_, header:=_variant_inout_, data:=_variant_inout_);</pre> | <p>Creates and initializes a data log file. The file is created in the PLC \DataLogs directory, named by the NAME parameter, and implicitly opened for write operations. You can use the Data log instructions to programmatically store run-time process data in flash memory of the CPU.</p> <p>STEP 7 automatically creates the associated instance DB when you insert the instruction.</p> |

¹ In the SCL example, "DataLogCreate_DB" is the name of the instance DB.

Table 8- 159 Data types for the parameters

| Parameter and type | Data type | Description |
|--------------------|-----------|---|
| REQ IN | Bool | A low to high (positive edge) signal starts the operation. (Default value: False) |
| RECORDS IN | UDint | The maximum number of data records the circular data log can contain before overwriting the oldest entry: The header record is not included. Sufficient available PLC load memory must exist in order to successfully create the data log. (Default value - 1) |
| FORMAT IN | UInt | Data log format: <ul style="list-style-type: none"> • 0 - Internal format (not supported) • 1 - Comma separated values "csv-eng" (Default value) |
| TIMESTAMP IN | UInt | Data time stamp format: Column headers for date and time fields are not required. The time stamp uses the system time (Coordinated Universal Time - UTC) and not the local time. <ul style="list-style-type: none"> • 0 - No time stamp • 1 - Date and time stamp (Default value) |

| Parameter and type | | Data type | Description |
|--------------------|--------|-----------|--|
| NAME | IN | Variant | Data log name: You provide the name. This variant only supports a String data type and can only be located in local, DB, or M memory. (Default value: ' ') The string reference is also used as the name of the data log file. The name characters must follow the Windows file system naming restrictions. Characters \ / : * ? " < > and the space character are not allowed. |
| ID | In/Out | DWord | Data log numeric identifier: You store this generated value for use with other Data log instructions. The ID parameter is only used as an output with the DataLogCreate instruction. (Default value: 0) Symbolic name access for this parameter is not allowed. |
| HEADER | In/Out | Variant | Pointer to data log column header names for the top row of the data matrix encoded in the CSV file. (Default value: null). HEADER data must be located in DB or M memory. The characters must follow standard CSV format rules with commas separating each column name. The data type may be a string, byte array, or character array. Character/byte arrays allow increased size, where strings are limited to a maximum of 255 bytes. The HEADER parameter is optional. If the HEADER is not parameterized, then no header row is created in the Data log file. |
| DATA | In/Out | Variant | Pointer to the record data structure, user defined type (UDT), or array. Record data must be located in DB or M memory. The DATA parameter specifies the individual data elements (columns) of a data log record and their data type. Structure data types are limited to a single nesting level. The number of data elements declared should correspond to the number of columns specified in the header parameter. The maximum number of data elements you can assign is 253 (with a timestamp) or 255 (without a timestamp). This restriction keeps your record inside the 256 column limit of an Excel sheet. |
| DONE | OUT | Bool | The DONE bit is TRUE for one scan, after the last request was completed with no error. (Default value: False) |
| BUSY | OUT | Bool | <ul style="list-style-type: none"> • 0 - No operation in progress • 1 - Operation on progress |
| ERROR | OUT | Bool | The ERROR bit is TRUE for one scan, after the last request was terminated with an error. The error code value at the STATUS parameter is valid only during the single scan where ERROR = TRUE. |
| STATUS | OUT | Word | Execution condition code (Default value: 0) |

A data log file is created with a pre-determined fixed sized based on the RECORDS and DATA parameters. The data records are organized as a circular log file. New records are appended to the data log file, until the maximum number of records that is specified by the RECORDS parameter is stored. The next record written will overwrite the oldest record. Another record write operation will overwrite the next oldest data record and so on.

Memory resource usage:

- The data logs consume only load memory.
- There is no set limit for the total number of data logs. The size of all data logs combined is limited by the available resources of load memory. Only eight data logs may be open at one time.
- The maximum possible number for the RECORDS parameter is the limit for an UDint number (4,294,967,295). The actual limit for the RECORD parameter depends on the size of a single record, the size of other data logs, and the available resources of load memory. In addition, Excel limits the number of rows allowed in an Excel sheet.

Note

Data log creation execution must be complete, before starting a data log write operation

- DataLogCreate and DataLogNewFile log file creation operations extend over many program scan cycles. The actual time required for the log file creation depends on the record structure and number of records. Your program logic must monitor and catch the DONE bit's transition to the TRUE state that signals the completion of a log file creation. If a DataLogWrite instruction is executed before a data log creation operation is complete, then the write operation will fail to write a new data log record as expected.
- In certain situations when a very fast program scan is running, data log creation can take an extended time. If the long creation time is too slow, you should ensure that the checkbox for the Enable minimum cycle time for cyclic OBs is active, and the minimum cycle time is set to one ms or greater. Refer to Configuring the cycle time and communication load (Page 97) for more information.

Note

The DataLogNewFile instruction copies an existing data log's record structure

If you want to prevent overwriting any data records, then you can use the DataLogNewFile instruction to create a new data log based on the current data log, after the current data log has stored the maximum number of records. New data records are stored in the new data log file. The old data log file and record data remain stored in flash memory.

Table 8- 160 Values of ERROR and STATUS

| ERROR | STATUS (W#16#....) | Description |
|-------|--------------------|--|
| 0 | 0000 | No error |
| 0 | 7000 | Call with no REQ edge: BUSY = 0, DONE = 0 |
| 0 | 7001 | First call with REQ edge (working): BUSY = 1, DONE = 0 |
| 0 | 7002 | N th call (working): BUSY = 1, DONE = 0 |

| ERROR | STATUS (W#16#....) | Description |
|-------|--------------------|---|
| 1 | 8070 | All internal instance memory is in use. |
| 1 | 807F | Internal error |
| 1 | 8090 | Invalid file name |
| 1 | 8091 | Name parameter is not a String reference. |
| 1 | 8093 | A data log already exists with that name. Use a different name, make sure the existing data log's .csv file is not open, and then use the File Browser page (Page 622) of the Web Server to delete the existing data log. |
| 1 | 8097 | Requested file length exceeds file system maximum. |
| 1 | 80B3 | Insufficient load memory available. |
| 1 | 80B4 | MC (Memory Cartridge) is write-protected. |
| 1 | 80C1 | Too many open files: No more than eight opened data log files are allowed. |
| 1 | 8253 | Invalid record count |
| 1 | 8353 | Invalid format selection |
| 1 | 8453 | Invalid timestamp selection |
| 1 | 8B24 | Invalid HEADER area assignment: For example, pointing to local memory |
| 1 | 8B51 | Invalid HEADER parameter data type |
| 1 | 8B52 | Too many HEADER parameter data elements |
| 1 | 8C24 | Invalid DATA area assignment: For example, pointing to local memory |
| 1 | 8C51 | Invalid DATA parameter data type |
| 1 | 8C52 | Too many DATA parameter data elements |

DataLogOpen (Open data log) instruction

Table 8- 161 DataLogOpen instruction

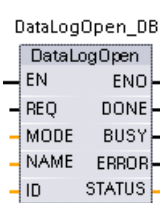
| LAD / FBD | SCL | Description |
|---|---|---|
|  | <pre>"DataLogOpen_DB" (req:=_bool_in_, mode:=_uint_in_, done=>_bool_out_, busy=>_bool_out_, error=>_bool_out_, status=>_word_out_, name:=_string_inout_, ID:=_dword_inout_);</pre> | <p>Opens a pre-existing data log file. A data log must be opened before you can write new records to the log. Data logs can be opened and closed individually. A maximum of eight data logs can be open at the same time.</p> <p>STEP 7 automatically creates the associated instance DB when you insert the instruction.</p> |

² In the SCL example, "DataLogOpen_DB" is the name of the instance DB.

Table 8- 162 Data types for the parameters

| Parameter and type | | Data type | Description |
|--------------------|--------|-----------|--|
| REQ | IN | Bool | A low to high (positive edge) signal starts the operation. (Default value: False) |
| MODE | IN | UInt | Operation mode: <ul style="list-style-type: none"> • 0 - Append to existing data (Default value) • 1 - Clear all existing records |
| NAME | IN | Variant | Name of an existing data log: This variant only supports a String data type and can only be located in local, DB, or M memory. (Default value: ' ') |
| ID | In/Out | DWord | Numeric identifier of a data log. (Default value: 0) Note: Symbolic name access for this parameter is not allowed. |
| DONE | OUT | Bool | The DONE bit is TRUE for one scan, after the last request was completed with no error. (Default value: False) |
| BUSY | OUT | Bool | <ul style="list-style-type: none"> • 0 - No operation in progress • 1 - Operation on progress |
| ERROR | OUT | Bool | The ERROR bit is TRUE for one scan, after the last request was terminated with an error. The error code value at the STATUS parameter is valid only during the single scan where ERROR = TRUE. |
| STATUS | OUT | Word | Execution condition code (Default value: 0) |

You can provide either the NAME or an ID (ID parameter as an input) of a pre-existing data log. If you provide both parameters and a valid ID does correspond to the NAME data log, then the ID is used, and the NAME ignored.

The NAME must be the name of a data log created by the DataLogCreate instruction. If only the NAME is provided and the NAME specifies a valid data log, then the corresponding ID will be returned (ID parameter as an output).

Note

General usage of data log files

- Data log files are automatically opened after the DataLogCreate and DataLogNewFile operations.
- Data log files are automatically closed after a PLC run to stop transition or a PLC power cycle.
- A Data log file must be open before a new DataLogWrite operation is possible.
- A maximum of eight data log files may be open at one time. More than eight data log files may exist, but some of them must be closed so no more than eight are open.

Table 8- 163 Values of ERROR and STATUS

| ERROR | STATUS (W#16#) | Description |
|-------|----------------|--|
| 0 | 0000 | No error |
| 0 | 0002 | Warning: Data log file already open by this application program |
| 0 | 7000 | Call with no REQ edge: BUSY = 0, DONE = 0 |
| 0 | 7001 | First call with REQ edge (working): BUSY = 1, DONE = 0 |
| 0 | 7002 | N th call (working): BUSY = 1, DONE = 0 |
| 1 | 8070 | All internal instance memory is in use. |
| 1 | 8090 | Data log definition is inconsistent with existing data log file. |
| 1 | 8091 | Name parameter is not a String reference. |
| 1 | 8092 | Data log does not exist. |
| 1 | 80C0 | Data log file is locked. |
| 1 | 80C1 | Too many open files: No more than eight opened data log files are allowed. |

DataLogWrite (Write data log) instruction

Table 8- 164 DataLogWrite instruction

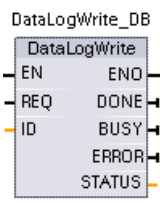
| LAD / FBD | SCL | Description |
|---|---|--|
|  | <pre>"DataLogWrite_DB" (req:=_bool_in_, done=>_bool_out_, busy=>_bool_out_, error=>_bool_out_, status=>_word_out_, ID:=_dword_inout_);</pre> | <p>Writes a data record into the specified data log. The pre-existing target data log must be open before a DataLogWrite operation is allowed.</p> <p>STEP 7 automatically creates the associated instance DB when you insert the instruction.</p> |

² In the SCL example, "DataLogWrite_DB" is the name of the instance DB.

Table 8- 165 Data types for the parameters

| Parameter and type | Data type | Description |
|--------------------|-----------|--|
| REQ | IN | Bool A low to high (positive edge) signal starts the operation. (Default value: False) |
| ID | In/Out | DWord Numeric data log identifier. Only used as an input for the DataLogWrite instruction. (Default value: 0) Note: Symbolic name access for this parameter is not allowed. |
| DONE | OUT | Bool The DONE bit is TRUE for one scan, after the last request was completed with no error. |
| BUSY | OUT | Bool <ul style="list-style-type: none"> 0 - No operation in progress 1 - Operation on progress |
| ERROR | OUT | Bool The ERROR bit is TRUE for one scan, after the last request was terminated with an error. The error code value at the STATUS parameter is valid only during the single scan where ERROR = TRUE. |
| STATUS | OUT | Word Execution condition code (Default value: 0) |

The memory address and data structure of the record buffer is configured by the DATA parameter of a DataLogCreate instruction. You must programmatically load the record buffer with current run-time process values and then execute the DataLogWrite instruction to move new record data from the buffer to the data log.

The ID parameter identifies a data log and data record configuration. The ID number is generated when a data log is created.

If there are empty records in the circular data log file, then the next available empty record will be written. If all records are full, then the oldest record will be overwritten.

| |
|--|
| NOTICE |
| Data log creation operations must be complete, before starting a data log write operation |
| DataLogCreate and DataLogNewFile log file creation operations extend over many program scan cycles. The actual time required for the log file creation depends on the record structure and number of records. Your program logic must monitor and catch the DONE bit's transition to the TRUE state that signals the completion of a log file creation. If a DataLogWrite instruction is executed before a data log creation operation is complete, then the write operation will fail to write a new data log record as expected. |

| |
|--|
| NOTICE |
| Potential for data log data loss during a CPU power failure |
| If there is a power failure during an incomplete DataLogWrite operation, then the data record being transferred to the data log could be lost. |

Table 8- 166 Values of ERROR and STATUS

| ERROR | STATUS (W#16#) | Description |
|-------|----------------|--|
| 0 | 0000 | No error |
| 0 | 0001 | Indicates that the data log is full: Each data log is created with a specified maximum number of records. The last record of the maximum number has been written. The next write operation will overwrite the oldest record. |
| 0 | 7000 | Call with no REQ edge: BUSY = 0, DONE = 0 |
| 0 | 7001 | First call with REQ edge (working): BUSY = 1, DONE = 0 |
| 0 | 7002 | N th call (working): BUSY = 1, DONE = 0 |
| 1 | 8070 | All internal instance memory is in use. |
| 1 | 8092 | Data log does not exist. |
| 1 | 80B0 | Data log file is not open (for explicit open mode only). |

DataLogClose (Close data log) instruction

Table 8- 167 DataLogClose instruction

| LAD / FBD | SCL | Description |
|-----------|---|---|
| | <pre>"DataLogClose_DB" (req:=_bool_in_, done=>_bool_out_, busy=>_bool_out_, error=>_bool_out_, status=>_word_out_, ID:=_dword_inout_);</pre> | <p>Closes an open data log file. DataLogWrite operations to a closed data log result in an error. No write operations are allowed to this data log until another DataLogOpen operation is performed.</p> <p>A transition to STOP mode will close all open data log files.</p> <p>STEP 7 automatically creates the associated instance DB when you insert the instruction.</p> |

² In the SCL example, "DataLogClose_DB" is the name of the instance DB.

Table 8- 168 Data types for the parameters

| Parameter and type | | Data type | Description |
|--------------------|--------|-----------|--|
| REQ | IN | Bool | A low to high (positive edge) signal starts the operation. (Default value: False) |
| ID | In/Out | DWord | Numeric identifier of a data log. Only used as an input for the DataLogClose instruction. (Default value: 0) Note: Symbolic name access for this parameter is not allowed. |
| DONE | OUT | Bool | The DONE bit is TRUE for one scan after the last request was completed with no error. |
| BUSY | OUT | Bool | <ul style="list-style-type: none"> • 0 - No operation in progress • 1- Operation on progress |
| ERROR | OUT | Bool | The ERROR bit is TRUE for one scan, after the last request was terminated with an error. The error code value at the STATUS parameter is valid only during the single scan where ERROR = TRUE. |
| STATUS | OUT | Word | Execution condition code (Default value: 0) |

Table 8- 169 Values of ERROR and STATUS

| ERROR | STATUS (W#16#) | Description |
|-------|----------------|--|
| 0 | 0000 | No error |
| 0 | 0001 | Data log not open |
| 0 | 7000 | Call with no REQ edge: BUSY = 0, DONE = 0 |
| 0 | 7001 | First call with REQ edge (working): BUSY = 1, DONE = 0 |
| 0 | 7002 | N th call (working): BUSY = 1, DONE = 0 |
| 1 | 8092 | Data log does not exist. |

DataLogNewFile (Data log in new file) instruction

Table 8- 170 DataLogNewFile instruction

| LAD / FBD | SCL | Description |
|-----------|---|---|
| | <pre>"DataLogNewFile_DB" (req:=_bool_in_, records:=_udint_in_, done=>_bool_out_, busy=>_bool_out_, error=>_bool_out_, status=>_word_out_, name:=_DataLog_out_, ID:=_dword_inout_);</pre> | <p>Allows your program to create a new data log file based upon an existing data log file. STEP 7 automatically creates the associated instance DB when you insert the instruction.</p> |

² In the SCL example, "DataLogNewFile_DB" is the name of the instance DB.

Table 8- 171 Data types for the parameters

| Parameter and type | | Data type | Description |
|--------------------|--------|-----------|--|
| REQ | IN | Bool | A low to high (positive edge) signal starts the operation. (Default value: False) |
| RECORDS | IN | UDInt | The maximum number of data records the circular data log can contain before overwriting the oldest entry. (Default value: 1) The header record is not included. Sufficient available CPU load memory must exist in order to successfully create the data log. |
| NAME | IN | VARIANT | Data log name: You provide the name. This variant only supports a String data type and can only be located in local, DB, or M memory. (Default value: '') The string reference is also used as the name of the data log file. The name characters must follow the Windows file system naming restrictions. Characters \ / : * ? " < > and the space character are not allowed.) |
| ID | In/Out | DWord | Numeric data log identifier(Default value: 0): <ul style="list-style-type: none"> At execution, the ID input identifies a valid data log. The new data log configuration is copied from this data log. After execution, the ID parameter becomes an output that returns the ID of the newly created data log file. Note: Symbolic name access for this parameter is not allowed. |
| DONE | OUT | Bool | The DONE bit is TRUE for one scan, after the last request was completed with no error. |
| BUSY | OUT | Bool | <ul style="list-style-type: none"> 0 - No operation in progress 1 - Operation on progress |
| ERROR | OUT | Bool | The ERROR bit is TRUE for one scan, after the last request was terminated with an error. The error code value at the STATUS parameter is valid only during the single scan where ERROR = TRUE. |
| STATUS | OUT | Word | Execution condition code (Default value: 0) |

You can execute the DataLogNewFile instruction when a data log becomes full or is deemed completed and you do not want to lose any data that is stored in the data log. A new empty data log file can be created based on the structure of the full Data log file. The header record will be duplicated from the original data log with the original data log properties (DATA record buffer, data format, and timestamp settings). The original Data log file is implicitly closed and the new Data log file is implicitly opened.

DataLogWrite parameter trigger: Your program must monitor the ERROR and STATUS parameters of each DataLogWrite operation. When the final record is written and a data log is full, the DataLogWrite ERROR bit = 1 and the DataLogWrite STATUS word = 1. These ERROR and STATUS values are valid for one scan only, so your monitoring logic must use ERROR = 1 as a time gate to capture the STATUS value and then test for STATUS = 1 (the data log is full).

DataLogNewFile operation: When your program logic gets the data log is full signal, this state is used to activate a DataLogNewFile operation. You must execute DataLogNewFile with the ID of an existing (usually full) and open data log, but a new unique NAME parameter. After the DataLogNewFile operation is done, a new data log ID value is returned (as an output parameter) that corresponds to the new data log name. The new data log file is implicitly opened and is ready to store new records. New DataLogWrite operations that are directed to the new data log file, must use the ID value returned by the DataLogNewFile operation.

| |
|---|
| NOTICE |
| <p>Data log creation operations must be complete, before starting a data log write operation</p> <p>DataLogCreate and DataLogNewFile log file creation operations extend over many program scan cycles. The actual time required for the log file creation depends on the record structure and number of records. Your program logic must monitor and catch the DONE bit's transition to the TRUE state that signals the completion of a log file creation. If a DataLogWrite instruction is executed before a data log creation operation is complete, then the write operation will fail to write a new data log record as expected.</p> |

Table 8- 172 Values of ERROR and STATUS

| ERROR | STATUS (W#16#) | Description |
|-------|----------------|--|
| 0 | 0000 | No error |
| 0 | 7000 | Call with no REQ edge: BUSY = 0, DONE = 0 |
| 0 | 7001 | First call with REQ edge (working): BUSY = 1, DONE = 0 |
| 0 | 7002 | N th call (working): BUSY = 1, DONE = 0 |
| 1 | 8070 | All internal instance memory is in use. |
| 1 | 8090 | Invalid file name |
| 1 | 8091 | Name parameter is not a String reference. |
| 1 | 8092 | Data log does not exist. |
| 1 | 8093 | Data log already exists. |
| 1 | 8097 | Requested file length exceeds file system maximum. |
| 1 | 80B3 | Insufficient load memory available. |

| ERROR | STATUS (W#16#) | Description |
|-------|----------------|------------------------|
| 1 | 80B4 | MC is write-protected. |
| 1 | 80C1 | Too many open files. |

8.7.2.3 Working with data logs

The data log files are stored as comma separated value format (*.csv) in persistent flash memory. You can view the data logs by using the PLC Web server feature or by removing the PLC memory card and inserting it in a standard PC card reader.

Viewing data logs with the PLC Web server feature

If the PLC PROFINET port and a PC are connected to a network, then you can use a PC web browser like Microsoft Internet Explorer or Mozilla Firefox to access the built-in PLC Web server. The PLC may be in run mode or stop mode when you operate the PLC Web server. If the PLC is in run mode, then your control program continues to execute while the PLC Web server is transferring log data through the network.

Web server access:

1. Enable the Web server in the Device Configuration for the target CPU (Page 603).
2. Connect your PC to the PLC through the PROFINET network (Page 606).
3. Access the CPU through the built-in Web server (Page 609).
4. Download, edit, and delete data log files with the "File Browser" standard Web page (Page 622).
5. Open the .csv file with a spreadsheet application like Microsoft Excel.

Viewing data logs on a PLC memory card

If the S7-1200 CPU has a "Program" type S7-1200 memory card inserted, then you can remove the memory card and insert the card into a standard SD (Secure Digital) or MMC (MultiMediaCard) card slot on a PC or PG. The PLC is in stop mode when the memory card is removed and your control program is not executed.

Use the Windows file explorer and navigate to the \DataLog directory on the memory card. All your *.csv data log files are located in this directory.

Make a copy of the data log files and put the copies on a local drive of your PC. Then, you can use Excel to open a local copy of a *.csv file and not the original file that is stored on the memory card.

| |
|---------------|
| NOTICE |
|---------------|

| |
|---|
| You can copy, but do not modify or delete data log files on a S7-1200 memory card using a PC card reader |
|---|

| |
|--|
| The standard Web server File Browser page is the recommended tool for viewing, downloading (copying), and deleting data log files. |
|--|

| |
|---|
| Direct browsing of the memory card file system by the Windows Explorer has the risk that you can accidentally delete/modify data log or other system files which can corrupt a file or make the memory card unusable. |
|---|

Viewing data logs from a Web browser

Even if you do not use the Web server feature, you can view data logs directly from a Web browser such as Internet Explorer or Mozilla Firefox. Simply enter the following text into the address bar of your browser using the IP address of your CPU and the actual name of the data log file you provided in STEP 7 instead of "MyDataLog":

`http://192.168.0.1/FileBrowser/Download?Path=/DataLogs/MyDataLog.csv`

The fixed addresses of data log files also make it possible to access them through third party file collection tools.

8.7.2.4 Limit to the size of data log files

Data log files share PLC load memory space with the program, program data, configuration data, user-defined Web pages, and PLC system data. A large program using internal load memory requires a large amount of load memory. There may be insufficient free space for data log files. In this case, you can use a "Program card" to increase the size of load memory. S7-1200 CPUs can use either internal or external load memory, but not both at once.

Refer to the memory card chapter for details about how to create a "Program" card (Page 130).

Maximum size rule for Data log files

The maximum size of one Data log file may not exceed the free load memory size or 500 MB, whichever is smaller. If your program uses more than one Data log file, then the combined size of all Data log files may not exceed the free load memory size.

Table 8- 173 Load memory size

| Data area | CPU 1211C | CPU 1212C | CPU 1214C | CPU 1215C, CPU 1217C | Data storage |
|--|--|-----------|-----------|-------------------------|---|
| Internal load memory flash memory | 1 MB | 1 MB | 4 MB | 4 MB | User program and program data, configuration data, Data logs, user-defined Web pages, and PLC system data |
| External load memory Optional "Program card" flash memory | 4 MB, 12 MB, 24 MB, 256 MB, 2 GB, or 32 GB depending on the SD card size | | | | |

Determining load memory free space

The amount of load memory free space varies during normal operations as the operating system uses and releases memory. Use the following steps to view the load memory memory size.

1. Establish an online connection between STEP 7 and the target S7-1200 PLC.
2. Download the program that controls your data log operations.
3. Create any optional user-defined Web pages that you need. The standard Web pages that access data logs are stored in PLC firmware and do not use load memory.
4. Use the Online and diagnostic tools to view total load memory size and free space (Page 783).

Calculating the size of a data log file (all data records)

When the data log file is created the maximum memory size is allocated. In addition to the size required for all the data records, you must include storage space for a data log header (if used), time stamp header (if used), record index header, and the minimum block size for memory allocation.

Use the following formula to determine the size of your data log files and ensure you do not violate the maximum size rule.

$$\text{Data log file size} = \text{header bytes} + \text{data bytes} + 512 \text{ bytes}$$

Header

Data log header bytes = header character bytes + 2 bytes

Header character bytes

- No data header and no timestamps = 7 bytes
- No data header and timestamps (has a timestamp header) = 21 bytes
- Data headers and no timestamps = number of character bytes in all column head text including separator commas
- Data headers and timestamps (has a timestamp header) = number of character bytes in all column head text including separator commas +21 bytes

Data

Data log data bytes = ((data bytes in one record + time stamp bytes) * number of records) + 12 bytes

Data bytes in one data record

The DataLogCreate DATA parameter points to a structure that assigns the number of data fields and the data type of each data field for one data log record.

Multiply the number of occurrences for a given data type by the number of bytes required. Repeat the process for each data type in a record and sum all the data bytes to get the total of all data elements in one record.

Size of individual data elements

Log data is stored as character bytes in the CSV (comma separated values) file format. The following table shows the number of bytes that are required to store each data element.

| Data type | Number of bytes (includes data plus one comma byte) |
|-----------|--|
| Bool | 2 |
| Byte | 5 |
| Word | 7 |
| DWord | 12 |
| Char | 4 |
| String | <p>Example 1: MyString String[10] The maximum string size is assigned as 10 characters. Text characters + automatic padding with blank characters = 10 bytes Opening and closing double quote + comma characters = 3 bytes 10 + 3 = 13 total bytes</p> <p>Example 2: Mystring2 String If no size is assigned with square brackets, then 254 bytes is allocated by default. Text characters + automatic padding with blank characters = 254 bytes Opening and closing double quote + comma characters = 3 bytes 254 + 3 = 257 total bytes</p> |
| USInt | 5 |
| UInt | 7 |

8.7 Recipes and Data logs

| | |
|-------|----|
| UDInt | 12 |
| SInt | 5 |
| Int | 7 |
| DInt | 12 |
| Real | 16 |
| LReal | 25 |
| Time | 15 |
| DTL | 24 |

Number of records in a data log file

The RECORDS parameter of the DataLogCreate instruction sets the maximum number of records in a data log file.

Time stamp bytes in one data record

- No time stamp = 0 bytes
- Time stamp = 20 bytes

See also

Monitoring the cycle time and memory usage (Page 792)

SIMATIC memory cards (Page 978)

8.7.2.5 Data log example program

This Data log example program does not show all the program logic necessary to get sample values from a dynamic process, but does show the key operations of the Data log instructions. The structure and number of log files that you use depends on your process control requirements.

Note

General usage of Data log files

- Data log files are automatically opened after the DataLogCreate and DataLogNew File operations.
 - Data log files are automatically closed after a PLC run to stop transition or a PLC power cycle.
 - A Data log file must be open before a DataLogWrite operation is possible.
 - A maximum of eight data log files may be open at one time. More than eight data log files may exist, but some of them must be closed so no more than eight are open.
-

Example Data log program

Example data log names, header text, and the MyData structure are created in a data block. The three MyData variables temporarily store new sample values. The process sample values at these DB locations are transferred to a data log file by executing the DataLogWrite instruction.

| My_Datalog_Vars | | | |
|-----------------|------------------|-----------|------------------------------|
| | Name | Data type | Start value |
| 1 | ▼ Static | | |
| 2 | MyNewDataLogName | String | 'MyNEWDataLog' |
| 3 | MyDataLogName | String | 'MyDataLog' |
| 4 | MyDataLogID | DWord | 0 |
| 5 | MyDataLogHeaders | String | 'Count,Temperature,Pressure' |
| 6 | ▼ MyData | Struct | |
| 7 | MyCount | Int | 0 |
| 8 | MyTemperature | Real | 0.0 |
| 9 | MyPressure | Real | 0.0 |

Network 1 REQ rising edge starts the data log creation process.

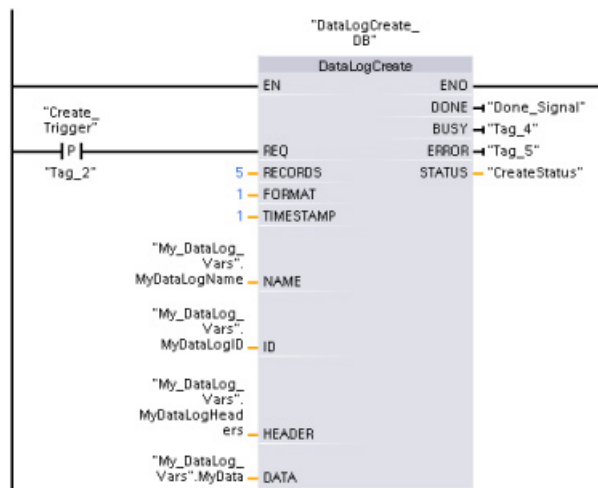

Network 2 Capture the DONE output from DataLogCreate because it is only valid for one scan.

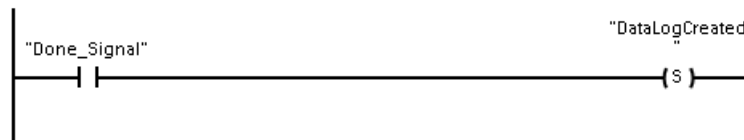

Network 3 A positive edge signal triggers when to store new process values in the MyData structure.

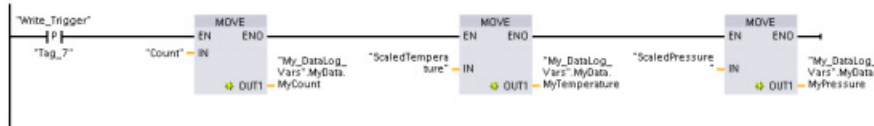

Network 4 The EN input state is based upon when the DataLogCreate operation is complete. A create operation extends over many scan cycles and must be complete before executing a write operation. The positive edge signal on the REQ input is the event that triggers an enabled write operation.

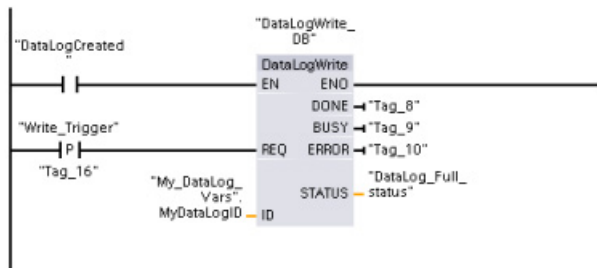

Network 5 Close the data log once the last record has been written. After executing the DataLogWrite operation that writes the last record, the log file full status is signaled when DataLogWrite STATUS output = 1.

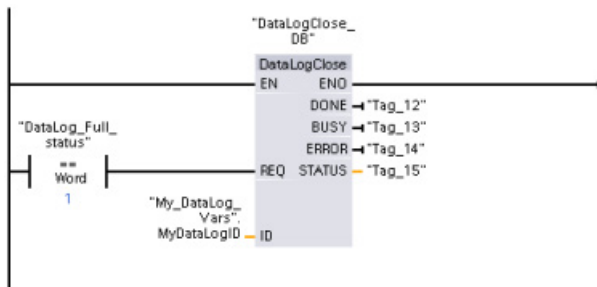

Network 6 A positive signal edge DataLogOpen REQ input simulates the user pushing a button on an HMI that opens a data log file. If you open a Data log file that has all records filled with process data, then the next DataLogWrite operation will overwrite the oldest record. You may want to preserve the old Data log and instead create a new data log, as shown in network 7.

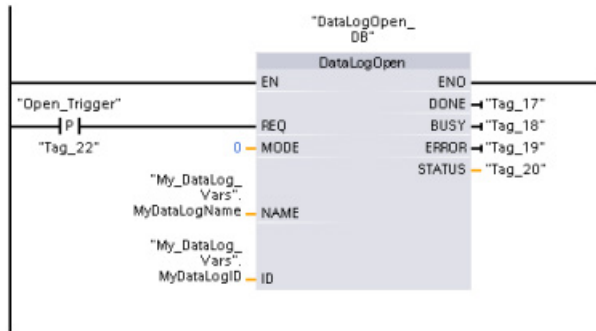

Network 7 The ID parameter is an IN/OUT type. First, you supply the ID value of the existing Data log whose structure you want to copy. After the DataLogNewFile operation is complete, a new and unique ID value for the new Data log is written back to the ID reference location. The required DONE bit = TRUE capture is not shown, refer to networks 1, 2, and 4 for an example of DONE bit logic.

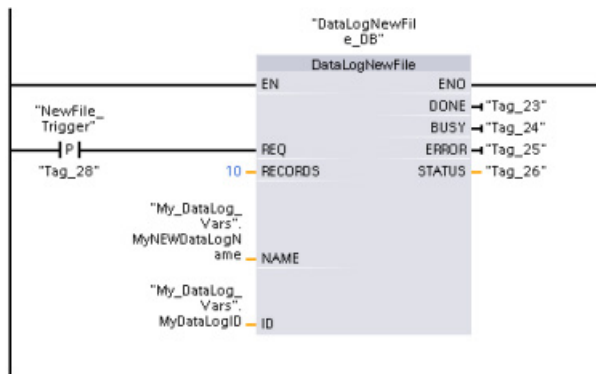

Data log files created by the example program viewed with the S7-1200 CPU Web server

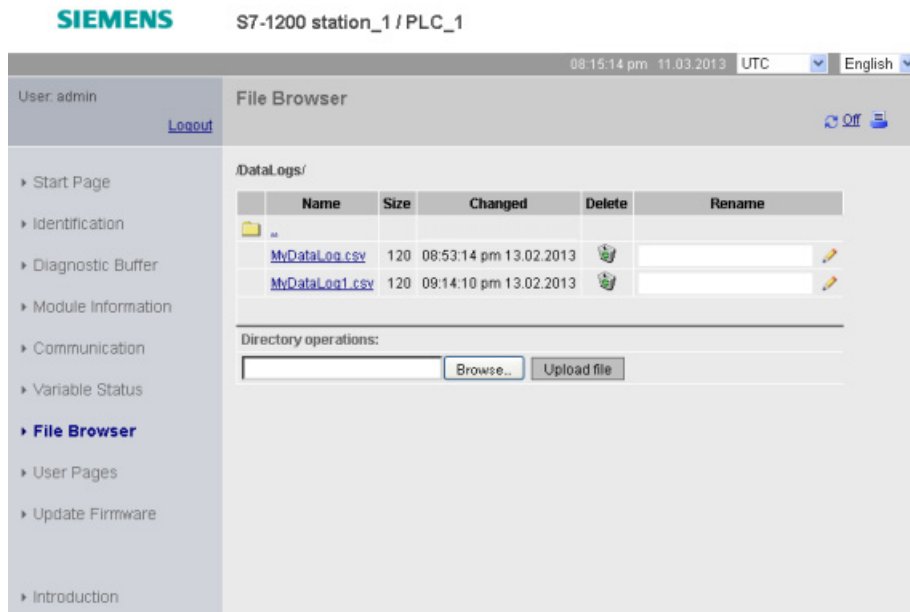

- ① The "Delete" option is not available if you are not logged in with modify privileges.
- ② The "Rename" option is not available if you are not logged in with modify privileges.

Table 8- 174 Downloaded .csv file examples viewed with Excel

| Two records written in a five record maximum file | <table border="1"> <thead> <tr> <th></th> <th>A</th> <th>B</th> <th>C</th> <th>D</th> <th>E</th> <th>F</th> </tr> </thead> <tbody> <tr> <td>1</td> <td>Record</td> <td>Date</td> <td>UTC Time</td> <td>Count</td> <td>Temperature</td> <td>Pressure</td> </tr> <tr> <td>2</td> <td>1</td> <td>9/29/2010</td> <td>21:01:46</td> <td>5</td> <td>5.00E+00</td> <td>5.00E+00</td> </tr> <tr> <td>3</td> <td>2</td> <td>9/29/2010</td> <td>21:01:47</td> <td>5</td> <td>5.00E+00</td> <td>5.00E+00</td> </tr> <tr> <td>4</td> <td colspan="6">//END</td> </tr> <tr> <td>5</td> <td colspan="6"></td> </tr> </tbody> </table> | | A | B | C | D | E | F | 1 | Record | Date | UTC Time | Count | Temperature | Pressure | 2 | 1 | 9/29/2010 | 21:01:46 | 5 | 5.00E+00 | 5.00E+00 | 3 | 2 | 9/29/2010 | 21:01:47 | 5 | 5.00E+00 | 5.00E+00 | 4 | //END | | | | | | 5 | | | | | | | | | | | | | | | | | | | | |
|--|---|-----------|----------|-------|-------------|----------|---|---|---|--------|------|----------|-------|-------------|----------|---|---|-----------|----------|---|----------|----------|---|---|-----------|----------|---|----------|----------|---|-------|-----------|----------|---|----------|----------|---|---|-----------|----------|---|----------|----------|---|---|-----------|----------|---|----------|----------|---|--|--|--|--|--|--|
| | A | B | C | D | E | F | | | | | | | | | | | | | | | | | | | | | | | | | | | | | | | | | | | | | | | | | | | | | | | | | | | |
| 1 | Record | Date | UTC Time | Count | Temperature | Pressure | | | | | | | | | | | | | | | | | | | | | | | | | | | | | | | | | | | | | | | | | | | | | | | | | | | |
| 2 | 1 | 9/29/2010 | 21:01:46 | 5 | 5.00E+00 | 5.00E+00 | | | | | | | | | | | | | | | | | | | | | | | | | | | | | | | | | | | | | | | | | | | | | | | | | | | |
| 3 | 2 | 9/29/2010 | 21:01:47 | 5 | 5.00E+00 | 5.00E+00 | | | | | | | | | | | | | | | | | | | | | | | | | | | | | | | | | | | | | | | | | | | | | | | | | | | |
| 4 | //END | | | | | | | | | | | | | | | | | | | | | | | | | | | | | | | | | | | | | | | | | | | | | | | | | | | | | | | | |
| 5 | | | | | | | | | | | | | | | | | | | | | | | | | | | | | | | | | | | | | | | | | | | | | | | | | | | | | | | | | |
| Five records in a Data log file with a five record maximum | <table border="1"> <thead> <tr> <th></th> <th>A</th> <th>B</th> <th>C</th> <th>D</th> <th>E</th> <th>F</th> </tr> </thead> <tbody> <tr> <td>1</td> <td>Record</td> <td>Date</td> <td>UTC Time</td> <td>Count</td> <td>Temperature</td> <td>Pressure</td> </tr> <tr> <td>2</td> <td>1</td> <td>9/30/2010</td> <td>20:26:56</td> <td>1</td> <td>9.86E+01</td> <td>3.52E+01</td> </tr> <tr> <td>3</td> <td>2</td> <td>9/30/2010</td> <td>20:28:43</td> <td>2</td> <td>1.00E+02</td> <td>3.73E+01</td> </tr> <tr> <td>4</td> <td>3</td> <td>9/30/2010</td> <td>20:29:03</td> <td>3</td> <td>9.99E+01</td> <td>3.68E+01</td> </tr> <tr> <td>5</td> <td>4</td> <td>9/30/2010</td> <td>20:29:21</td> <td>4</td> <td>9.95E+01</td> <td>3.64E+01</td> </tr> <tr> <td>6</td> <td>5</td> <td>9/30/2010</td> <td>20:30:19</td> <td>5</td> <td>9.92E+01</td> <td>3.74E+01</td> </tr> <tr> <td>7</td> <td colspan="6"></td> </tr> </tbody> </table> | | A | B | C | D | E | F | 1 | Record | Date | UTC Time | Count | Temperature | Pressure | 2 | 1 | 9/30/2010 | 20:26:56 | 1 | 9.86E+01 | 3.52E+01 | 3 | 2 | 9/30/2010 | 20:28:43 | 2 | 1.00E+02 | 3.73E+01 | 4 | 3 | 9/30/2010 | 20:29:03 | 3 | 9.99E+01 | 3.68E+01 | 5 | 4 | 9/30/2010 | 20:29:21 | 4 | 9.95E+01 | 3.64E+01 | 6 | 5 | 9/30/2010 | 20:30:19 | 5 | 9.92E+01 | 3.74E+01 | 7 | | | | | | |
| | A | B | C | D | E | F | | | | | | | | | | | | | | | | | | | | | | | | | | | | | | | | | | | | | | | | | | | | | | | | | | | |
| 1 | Record | Date | UTC Time | Count | Temperature | Pressure | | | | | | | | | | | | | | | | | | | | | | | | | | | | | | | | | | | | | | | | | | | | | | | | | | | |
| 2 | 1 | 9/30/2010 | 20:26:56 | 1 | 9.86E+01 | 3.52E+01 | | | | | | | | | | | | | | | | | | | | | | | | | | | | | | | | | | | | | | | | | | | | | | | | | | | |
| 3 | 2 | 9/30/2010 | 20:28:43 | 2 | 1.00E+02 | 3.73E+01 | | | | | | | | | | | | | | | | | | | | | | | | | | | | | | | | | | | | | | | | | | | | | | | | | | | |
| 4 | 3 | 9/30/2010 | 20:29:03 | 3 | 9.99E+01 | 3.68E+01 | | | | | | | | | | | | | | | | | | | | | | | | | | | | | | | | | | | | | | | | | | | | | | | | | | | |
| 5 | 4 | 9/30/2010 | 20:29:21 | 4 | 9.95E+01 | 3.64E+01 | | | | | | | | | | | | | | | | | | | | | | | | | | | | | | | | | | | | | | | | | | | | | | | | | | | |
| 6 | 5 | 9/30/2010 | 20:30:19 | 5 | 9.92E+01 | 3.74E+01 | | | | | | | | | | | | | | | | | | | | | | | | | | | | | | | | | | | | | | | | | | | | | | | | | | | |
| 7 | | | | | | | | | | | | | | | | | | | | | | | | | | | | | | | | | | | | | | | | | | | | | | | | | | | | | | | | | |
| After one additional record is written to the file above which is full, the sixth write operation overwrites the oldest record one with record six. Another write operation will overwrite record two with record seven and so on. | <table border="1"> <thead> <tr> <th></th> <th>A</th> <th>B</th> <th>C</th> <th>D</th> <th>E</th> <th>F</th> </tr> </thead> <tbody> <tr> <td>1</td> <td>Record</td> <td>Date</td> <td>UTC Time</td> <td>Count</td> <td>Temperature</td> <td>Pressure</td> </tr> <tr> <td>2</td> <td>6</td> <td>9/30/2010</td> <td>20:32:03</td> <td>6</td> <td>9.86E+01</td> <td>3.58E+01</td> </tr> <tr> <td>3</td> <td>2</td> <td>9/30/2010</td> <td>20:28:43</td> <td>2</td> <td>1.00E+02</td> <td>3.73E+01</td> </tr> <tr> <td>4</td> <td>3</td> <td>9/30/2010</td> <td>20:29:03</td> <td>3</td> <td>9.99E+01</td> <td>3.68E+01</td> </tr> <tr> <td>5</td> <td>4</td> <td>9/30/2010</td> <td>20:29:21</td> <td>4</td> <td>9.95E+01</td> <td>3.64E+01</td> </tr> <tr> <td>6</td> <td>5</td> <td>9/30/2010</td> <td>20:30:19</td> <td>5</td> <td>9.92E+01</td> <td>3.74E+01</td> </tr> <tr> <td>7</td> <td colspan="6"></td> </tr> </tbody> </table> | | A | B | C | D | E | F | 1 | Record | Date | UTC Time | Count | Temperature | Pressure | 2 | 6 | 9/30/2010 | 20:32:03 | 6 | 9.86E+01 | 3.58E+01 | 3 | 2 | 9/30/2010 | 20:28:43 | 2 | 1.00E+02 | 3.73E+01 | 4 | 3 | 9/30/2010 | 20:29:03 | 3 | 9.99E+01 | 3.68E+01 | 5 | 4 | 9/30/2010 | 20:29:21 | 4 | 9.95E+01 | 3.64E+01 | 6 | 5 | 9/30/2010 | 20:30:19 | 5 | 9.92E+01 | 3.74E+01 | 7 | | | | | | |
| | A | B | C | D | E | F | | | | | | | | | | | | | | | | | | | | | | | | | | | | | | | | | | | | | | | | | | | | | | | | | | | |
| 1 | Record | Date | UTC Time | Count | Temperature | Pressure | | | | | | | | | | | | | | | | | | | | | | | | | | | | | | | | | | | | | | | | | | | | | | | | | | | |
| 2 | 6 | 9/30/2010 | 20:32:03 | 6 | 9.86E+01 | 3.58E+01 | | | | | | | | | | | | | | | | | | | | | | | | | | | | | | | | | | | | | | | | | | | | | | | | | | | |
| 3 | 2 | 9/30/2010 | 20:28:43 | 2 | 1.00E+02 | 3.73E+01 | | | | | | | | | | | | | | | | | | | | | | | | | | | | | | | | | | | | | | | | | | | | | | | | | | | |
| 4 | 3 | 9/30/2010 | 20:29:03 | 3 | 9.99E+01 | 3.68E+01 | | | | | | | | | | | | | | | | | | | | | | | | | | | | | | | | | | | | | | | | | | | | | | | | | | | |
| 5 | 4 | 9/30/2010 | 20:29:21 | 4 | 9.95E+01 | 3.64E+01 | | | | | | | | | | | | | | | | | | | | | | | | | | | | | | | | | | | | | | | | | | | | | | | | | | | |
| 6 | 5 | 9/30/2010 | 20:30:19 | 5 | 9.92E+01 | 3.74E+01 | | | | | | | | | | | | | | | | | | | | | | | | | | | | | | | | | | | | | | | | | | | | | | | | | | | |
| 7 | | | | | | | | | | | | | | | | | | | | | | | | | | | | | | | | | | | | | | | | | | | | | | | | | | | | | | | | | |

8.8 Data block control

8.8.1 READ_DBL and WRIT_DBL (Read/write a data block in load memory) instructions

Table 8- 175 READ_DBL and WRIT_DBL instructions

| LAD / FBD | SCL | Description |
|-----------|---|--|
| | <pre>READ_DBL (req:=_bool_in_, srcblk:=_variant_in_, busy=>_bool_out_, dstblk=>_variant_out_);</pre> | <p>Copies DB start values or part of the values, from load memory to a target DB in the work memory.</p> <p>The content of load memory is not changed during the copy process.</p> |
| | <pre>WRIT_DBL (req:=_bool_in_, srcblk:=_variant_in_, busy=>_bool_out_, dstblk=>_variant_out_);</pre> | <p>Copies DB current values or part of the values from work memory to a target DB in load memory.</p> <p>The content of work memory is not changed during the copy process.</p> |

Table 8- 176 Data types for the parameters

| Parameter and type | Data type | Description | |
|--------------------|-----------|-------------|--|
| REQ | IN | BOOL | A high signal starts the operation, if BUSY = 0. |
| SRCBLK | IN | VARIANT | READ_DBL: Pointer to the source data block in load memory WRIT_DBL: Pointer to the source data block in work memory |
| RET_VAL | OUT | INT | Execution condition code |
| BUSY | OUT | BOOL | BUSY = 1 signals that the reading/writing process is not complete. |
| DSTBLK | OUT | VARIANT | READ_DBL: Pointer to the destination data block in work memory WRIT_DBL: Pointer to the destination data block in load memory |

Typically, a DB is stored in both load memory (flash) and work memory (RAM). The start values (initial values) are always stored in load memory, and the current values are always stored in work memory. READ_DBL can be used to copy a set of start values from load memory to the current values of a DB in work memory that is referenced by your program. You can use WRIT_DBL to update the start values stored in internal load memory or memory card from current values in work memory.

Note

Avoid excessive WRIT_DBL flash memory write operations

The WRIT_DBL instruction performs write operations in flash memory (internal load memory or memory card). WRIT_DBL should be used for infrequent updates like a production process changes.

The data blocks used by READ_DBL and WRIT_DBL must have been previously created by STEP 7 before you can use these instructions. If the source DB is created as a "standard" type then the destination DB must also be the "standard" type. If the source data block is created as an "optimized" type then the destination data block must also be the "optimized" type.

If the DBs are standard, then you can specify either a tag name or a P# value. The P# value allows you to specify and copy any number of elements of the specified size (Byte, Word, or DWord). Thus, you can copy part or all of a DB. If the DBs are optimized, you can only specify a tag name; you cannot use the P# operator. If you specify a tag name for either standard or optimized DBs (or for other work-memory types), then whatever is referenced by this tag name is copied. This could be a user-defined type, an array, or a basic element. Type Struct can only be used by these instructions if the DB is standard, not optimized. You must use a user-defined type (UDT) if it is a structure in optimized memory. Only a user-defined type ensures that the "data types" are exactly the same for both the source and destination structures.

Note

Using a structure (data type Struct) in an "optimized" DB

When using a Struct data type with "optimized" DBs, you must first create a user-defined data type (UDT) for the Struct. You then configure both the source and destination DBs with the UDT. The UDT ensures that the data types within the Struct remain consistent for both DBs.

For "standard" DBs, you use the Struct without creating a UDT.

READ_DBL and WRIT_DBL execute asynchronously to the cyclic program scan. The processing extends over multiple READ_DBL and WRIT_DBL calls. You start the DB transfer job by calling with REQ = 1 and then monitor the BUSY and RET_VAL outputs to determine when the data transfer is complete and correct.

To ensure data consistency, do not modify the destination area during the processing of READ_DBL or the source area during the processing of WRIT_DBL (that is, as long as the BUSY parameter is TRUE).

SRCBLK and DSTBLK parameter restrictions:

- A data block must have been previously created before it can be referenced.
- The length of a VARIANT pointer of type BOOL must be divisible by 8.
- The length of a VARIANT pointer of type STRING must be the same in the source and destination pointers.

Recipes and machine setup information

You can use the READ_DBL and WRIT_DBL instructions to manage recipes or machine setup information. This essentially becomes another method of achieving retentive data for values that do not change often, although you would want to limit the number of writes to prevent wearing out the flash prematurely. This effectively allows you to increase the amount of retentive memory beyond that supported for the normal power-down retentive data, at least for values that do not change often. You could save recipe information or machine-setup information from work memory to load memory using the WRIT_DBL instruction, and you could retrieve such information from load memory into work memory using the READ_DBL instruction.

Table 8- 177 Condition codes

| RET_VAL (W#16#...) | Description |
|-----------------------|--|
| 0000 | No error |
| 0081 | Warning: that the source area is smaller than the destination area. The source data is copied completely with the extra bytes in the destination area unchanged. |
| 7000 | Call with REQ = 0: BUSY = 0 |
| 7001 | First call with REQ = 1 (working): BUSY = 1 |
| 7002 | N th call (working): BUSY = 1 |
| 8051 | Data block type error |
| 8081 | The source area is larger than the destination area. The destination area is completely filled and the remaining bytes of the source are ignored. |
| 8251 | Source data block type error |
| 82B1 | Missing source data block |
| 82C0 | The source DB is being edited by another statement or a communication function. |
| 8551 | Destination data block type error |
| 85B1 | Missing destination data block |
| 85C0 | The destination DB is being edited by another statement or a communication function. |
| 80C3 | More than 50 READ_DBL or 50 WRIT_DBL statements are currently queued for execution. |

See also Recipes (Page 369)

8.9 Address handling

8.9.1 LOG2GEO (Determine the slot from the hardware identifier) instruction

You use the LOG2GEO instruction to determine the geographical address (module slot) from the logical address belonging to a hardware identifier.

Table 8- 178 LOG2GEO instruction

| LAD / FBD | SCL | Description |
|-----------|--|---|
| | <pre>ret_val := LOG2GEO(laddr:=_word_in_, GEOADDR:=_variant_in_out_);</pre> | <p>You use the LOG2GEO instruction to determine the module slot belonging to a hardware identifier.</p> |

The LOG2GEO instruction determines the geographic address of a logical address based upon the hardware identifier:

- Use the LADDR parameter to select the logical address based upon the hardware identifier.
- The GEOADDR contains the geographic address of the logical address given at the LADDR input..

Note

In the cases where the HW type does not support a component, a subslot number for a module 0 is returned.

An error is provided if the LADDR input does not address a HW object.

Table 8- 179 Data types for the parameters

| Parameter and type | | Data type | Description |
|--------------------|--------|-----------|---|
| LADDR | IN | HW_ANY | Hardware identifier of the IO system or the module. The number is assigned automatically and is stored in the properties of the CPU or the interface of the hardware configuration. |
| RET_VAL | OUT | Int | Error code of the instruction |
| GEOADDR | IN_OUT | Variant | Pointer to the GEOADDR system data type |

Table 8- 180 GEOADDR system data type

| Parameter name | Data type | Description |
|----------------|-----------|---|
| GEOADDR | STRUCT | |
| HWTYP | UNIT | Hardware type: <ul style="list-style-type: none"> • 1: IO system (PROFINET/PROFIBUS) • 2: IO device/DP slave • 3: Rack • 4: Module • 5: Submodule If a hardware type is not supported by the instruction, a HWTYP "0" is output. |
| AREA | UNIT | Area ID: <ul style="list-style-type: none"> • 0 = CPU • 1 = PROFINET IO • 2 = PROFIBUS DP |
| IOSYSTEM | UNIT | PROFINET IO system (0 = central device in rack 0-3) |
| STATION | UNIT | <ul style="list-style-type: none"> • Number of the rack if the area identifier AREA = 0. • Station number if area identifier AREA > 0. |
| SLOT | UNIT | Slot number |
| SUBSLOT | UNIT | Number of the submodule. If no submodule can be inserted, this parameter has the value "0". |

Table 8- 181 Condition codes

| RET_VAL (W#16#...) | Description |
|-----------------------|--|
| 0000 | No error |
| 8090 | The address specified at the LADDR parameter is invalid. |

8.9.2 RD_ADDR (Determine the IO addresses from the hardware identifier) instruction

You use the RD_ADDR instruction to get the I/O addresses of a submodule.

Table 8- 182 RD_ADDR instruction

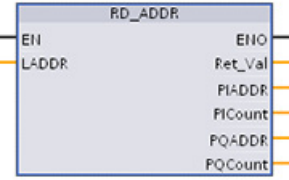
| LAD / FBD | SCL | Description |
|---|--|---|
|  | <pre>ret_val := RD_ADDR(laddr:=_word_in_, PIADDR=>_uint_out_, PICount=>_uint_out_, PQADDR=>_uint_out_, PQCount=>_uint_out_,);</pre> | <p>You use the RD_ADDR instruction to get the I/O addresses of a submodule.</p> |

The RD_ADDR instruction determines the length and the start address of the inputs or outputs based on the hardware identifier of a submodule:

- Use the LADDR parameter to select the input or output module based upon the hardware identifier.
- The following output parameters are used depending on whether it is an input module or output module:
 - In the case of an input module, the determined values are output at the PIADDR and PICOUNT parameters.
 - In the case of an output module, the determined values are output at the PQADDR and PQCOUNT parameters.
- The PIADDR and PQADDR parameters each contain the start address of the I/O addresses of the module.
- The PICOUNT and PQCOUNT parameters each contain the number of bytes of the inputs or outputs (1 byte for 8 inputs/outputs, 2 bytes for 16 inputs/outputs).

Table 8- 183 Data types for the parameters

| Parameter and type | Data type | Description | |
|--------------------|-----------|-------------|--|
| LADDR | IN | HW_IO | Hardware identifier of the (sub)module |
| RET_VAL | OUT | Int | Error code of the instruction |
| PIADDR | OUT | UDInt | Start address of the input module |
| PICOUNT | OUT | UInt | Number of bytes of the inputs |
| PQADDR | OUT | UDInt | Start address of the output module |
| PQCOUNT | OUT | UInt | Number of bytes of the outputs |

Table 8- 184 Condition codes

| RET_VAL (W#16#...) | Description |
|-----------------------|--|
| 0000 | No error |
| 8090 | Hardware identifier of the module at the LADDR parameter is invalid. |

8.10 Common error codes for the "Extended" instructions

Table 8- 185 Common condition codes for the extended instructions

| Condition code (W#16#....) ¹ | Description |
|---|--------------------------------|
| 8x22 ² | Area too small for input |
| 8x23 | Area too small for output |
| 8x24 | Illegal input area |
| 8x25 | Illegal output area |
| 8x28 | Illegal input bit assignment |
| 8x29 | Illegal output bit assignment |
| 8x30 | Output area is a read-only DB. |
| 8x3A | DB does not exist. |

¹ If one of these errors occurs when a code block is executed, then the CPU remains in RUN (default) or can be configured to go to STOP. Optionally, you can use the GetError or GetErrorID instructions within that code block to handle the error locally (CPU remains in RUN), and create a programmed reaction to the error.

² The "x" represents the parameter number with the error. Parameter numbers start with 1.

Technology instructions

9.1 High-speed counter

Table 9- 1 CTRL_HSC instruction

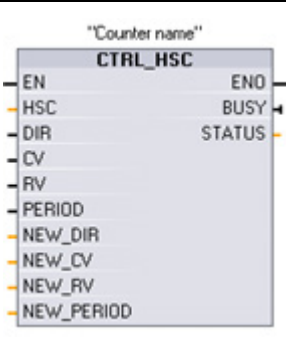
| LAD / FBD | SCL | Description |
|--|--|--|
|  | <pre>"CTRL_HSC_1_DB" (hsc:= hw_hsc_in_, dir:= bool_in_, cv:= bool_in_, rv:= bool_in_, period:= bool_in_, new_dir:= int_in_, new_cv:= int_in_, new_rv:= dint_in_, new_period:= int_in_, busy:= bool_out_, status:= word out);</pre> | <p>Each CTRL_HSC (Control high-speed counter) instruction uses a structure stored in a DB to maintain counter data. You assign the DB when the CTRL_HSC instruction is placed in the editor.</p> |

- 1 STEP 7 automatically creates the DB when you insert the instruction.
- 2 In the SCL example, "CTRL_HSC_1_DB" is the name of the instance DB.

Table 9- 2 Data types for the parameters

| Parameter and type | Data type | Description |
|---------------------|-----------|---|
| HSC | IN | HW_HSC HSC identifier |
| DIR ^{1, 2} | IN | Bool 1 = Request new direction |
| CV ¹ | IN | Bool 1 = Request to set new counter value |
| RV ¹ | IN | Bool 1= Request to set new reference value |
| PERIOD ¹ | IN | Bool 1 = Request to set new period value (only for frequency measurement mode) |
| NEW_DIR | IN | Int New direction: 1= forward, -1= backward |
| NEW_CV | IN | DInt New counter value |
| NEW_RV | IN | DInt New reference value |
| NEW_PERIOD | IN | Int New period value in seconds(only for frequency measurement mode): 1= 1 s 2 = .1 s 3 = 0.1 s |

| Parameter and type | | Data type | Description |
|--------------------|-----|-----------|--------------------------|
| BUSY ³ | OUT | Bool | Function is busy |
| STATUS | OUT | Word | Execution condition code |

- ¹ If an update of a parameter value is not requested, then the corresponding input values are ignored.
- ² The DIR parameter is only valid if the configured counting direction is set to "User program (internal direction control)". You determine how to use this parameter in the HSC device configuration.
- ³ For an HSC on the CPU or on the SB, the BUSY parameter always has a value of 0.

You configure the parameters for each HSC in the device configuration for the CPU for counting/frequency function, reset options, interrupt event configuration, hardware I/O, and count value address.

Some of the parameters for the HSC can be modified by your user program to provide program control of the counting process:

- Set the counting direction to a NEW_DIR value
- Set the current count value to a NEW_CV value
- Set the reference value to a NEW_RV value
- Set the period value (for frequency measurement mode) to a NEW_PERIOD value

If the following Boolean flag values are set to 1 when the CTRL_HSC instruction is executed, the corresponding NEW_xxx value is loaded to the counter. Multiple requests (more than one flag is set at the same time) are processed in a single execution of the CTRL_HSC instruction.

- DIR = 1 is a request to load a NEW_DIR value, 0 = no change
- CV = 1 is a request to load a NEW_CV value, 0 = no change
- RV = 1 is a request to load a NEW_RV value, 0 = no change
- PERIOD = 1 is a request to load a NEW_PERIOD value, 0 = no change

The CTRL_HSC instruction is typically placed in a hardware interrupt OB that is executed when the counter hardware interrupt event is triggered. For example, if a CV=RV event triggers the counter interrupt, then a hardware interrupt OB code block executes the CTRL_HSC instruction and can change the reference value by loading a NEW_RV value.

The current count value is not available in the CTRL_HSC parameters. The process image address that stores the current count value is assigned during the hardware configuration of the high-speed counter. You may use program logic to directly read the count value. The value returned to your program will be a correct count for the instant in which the counter was read. The counter will continue to count high-speed events. Therefore, the actual count value could change before your program completes a process using an old count value.

HSC current count value: Program access, value range, and rollover behavior

The CPU stores the current value of each HSC in an input (I) address. The following table shows the default addresses assigned to the current value for each HSC. You can change the I address for the current value by modifying the properties of the CPU in the Device Configuration.

High-speed counters use a DInt value to store the current count value. A DInt count value has a range of -2147483648 to +2147483647. The counter rolls over from the maximum positive value to the maximum negative value when counting up, and from the maximum negative value to the maximum positive value when counting down.

| HSC | Current value data type | Default current value address |
|------|-------------------------|-------------------------------|
| HSC1 | DInt | ID1000 |
| HSC2 | DInt | ID1004 |
| HSC3 | DInt | ID1008 |
| HSC4 | DInt | ID1012 |
| HSC5 | DInt | ID1016 |
| HSC6 | DInt | ID1020 |

If an error occurs, ENO is set to 0 and the STATUS output indicates a condition code.

Table 9- 3 Execution condition codes

| STATUS (W#16#) | Description |
|----------------|--|
| 0 | No error |
| 80A1 | HSC identifier does not address a HSC |
| 80B1 | Illegal value in NEW_DIR |
| 80B2 | Illegal value in NEW_CV |
| 80B3 | Illegal value in NEW_RV |
| 80B4 | Illegal value in NEW_PERIOD |
| 80C0 | Multiple access to the high-speed counter |
| 80D0 | High-speed counter (HSC) not enabled in CPU hardware configuration |

9.1.1 Operation of the high-speed counter

High-speed counters (HSC) can count events that occur faster than the cyclic OB execution rate. If the events to be counted occur slower than the execution rate of the OB, you can use CTU, CTD, or CTUD standard counter instructions. If the events occur faster than the OB execution rate, then use the faster HSC device. The CTRL_HSC instruction allows your program to programmatically change some of the HSC parameters.

For example: You can use the HSC as an input for an incremental shaft encoder. The shaft encoder provides a specified number of counts per revolution and a reset pulse that occurs once per revolution. The clock(s) and the reset pulse from the shaft encoder provide the inputs to the HSC.

The HSC is loaded with the first of several presets, and the outputs are activated for the time period where the current count is less than the current preset. The HSC provides an interrupt when the current count is equal to preset, when reset occurs, and also when there is a direction change.

As each current-count-value-equals-preset-value interrupt event occurs, a new preset is loaded and the next state for the outputs is set. When the reset interrupt event occurs, the first preset and the first output states are set, and the cycle is repeated.

9.1 High-speed counter

Since the interrupts occur at a much lower rate than the counting rate of the HSC, precise control of high-speed operations can be implemented with relatively minor impact to the scan cycle of the CPU. The method of interrupt attachment allows each load of a new preset to be performed in a separate interrupt routine for easy state control. Alternatively, all interrupt events can be processed in a single interrupt routine.

HSC input channel selection

Use the following table and ensure that the CPU and SB input channels that you connect can support the maximum pulse rates in your process signals.

Note

CPU and SB input channels (V4 or later firmware) have configurable input filter times

Earlier firmware versions had fixed HSC input channels and fixed filter times that could not be changed.

V4 or later versions allow you to assign input channels and filter times. The default input filter setting of 6.4 ms may be too slow for your process signals. The filter times for the HSC inputs must be optimized for your HSC application. See "Configuring digital input filter times (Page 144)" for details.

Table 9- 4 CPU input: maximum frequency

| CPU | CPU Input channel | 1 or 2 phase mode | A/B Quadrature phase mode |
|-----------------|--|-------------------|---------------------------|
| 1211C | la.0 to la.5 | 100 kHz | 80 kHz |
| 1212C | la.0 to la.5 | 100 kHz | 80 kHz |
| | la.6, la.7 | 30 kHz | 20 kHz |
| 1214C and 1215C | la.0 to la.5 | 100kHz | 80kHz |
| | la.6 to lb.5 | 30 kHz | 20 kHz |
| 1217C | la.0 to la.5 | 100 kHz | 80 kHz |
| | la.6 to lb.1 | 30 kHz | 20 kHz |
| | lb.2 to lb.5 (.2+, .2- to .5+, .5-) | 1 MHz | 1 MHz |

Table 9- 5 SB signal board input: maximum frequency (optional board)

| SB signal board | SB input channel | 1 or 2 phase mode | A/B Quadrature phase mode |
|------------------|------------------|-------------------|---------------------------|
| SB 1221, 200 kHz | le.0 to le.3 | 200kHz | 160 kHz |
| SB 1223, 200 kHz | le.0, le.1 | 200kHz | 160 kHz |
| SB 1223 | le.0, le.1 | 30 kHz | 20 kHz |

Selecting the functionality for the HSC

All HSCs function the same way for the same counter mode of operation. Counter mode, direction control, and initial direction are assigned in the CPU device configuration for HSC function properties.

There are four basic types of HSC:

- Single-phase counter with internal direction control
- Single-phase counter with external direction control
- Two-phase counter with 2 clock inputs
- A/B phase quadrature counter

You can use each HSC type with or without a reset input. When you activate the reset input (with some restrictions, see the following table), the current value is cleared and held clear until you deactivate the reset input.

- Frequency function: Some HSC modes allow the HSC to be configured (Type of counting) to report the frequency instead of a current count of pulses. Three different frequency measuring periods are available: 0.01, 0.1, or 1.0 seconds.

The frequency measuring period determines how often the HSC calculates and reports a new frequency value. The reported frequency is an average value determined by the total number of counts in the last measuring period. If the frequency is rapidly changing, the reported value will be an intermediate between the highest and lowest frequency occurring during the measuring period. The frequency is always reported in Hertz (pulses per second) regardless of the frequency measuring period setting.

- Counter modes and inputs: The following table shows the inputs used for the clock, direction control, and reset functions associated with the HSC.

The same input cannot be used for two different functions, but any input not being used by the present mode of its HSC can be used for another purpose. For example, if HSC1 is in a mode that uses two built-in inputs but does not use the third external reset input (default assignment at I0.3), then I0.3 can be used for edge interrupts or for HSC 2.

Table 9- 6 Counting modes for HSC

| Type | Input 1 | Input 2 | Input 3 | Function |
|--|----------|------------|--------------------|--------------------|
| Single-phase counter with internal direction control | Clock | - | - | Count or frequency |
| | | | Reset | Count |
| Single-phase counter with external direction control | Clock | Direction | - | Count or frequency |
| | | | Reset | Count |
| Two-phase counter with 2 clock inputs | Clock up | Clock down | - | Count or frequency |
| | | | Reset | Count |
| A/B-phase quadrature counter | Phase A | Phase B | - | Count or frequency |
| | | | Reset ¹ | Count |

¹ For an encoder: Phase Z, Home

Input addresses for the HSC

When you configure the CPU, you have the option to enable and configure the "Hardware inputs" for each HSC.

All HSC inputs must be connected to terminals on the CPU module or optional signal board that plugs into the front of the CPU module.

Note

As shown in the following tables, the default assignments for the optional signals for the different HSCs overlap. For example, the optional external reset for HSC 1 uses the same input as one of the inputs for HSC 2. For

For V4 CPUs or later, you can reassign the HSC inputs during the CPU configuration. You do not have to use the default input assignments.

Always ensure that you have configured your HSCs so that any one input is **not** being used by two HSCs.

The following tables show the HSC input default assignments for the on-board I/O of CPUs and an optional SB. (If the SB model selected has only 2 inputs, only 4.0 and 4.1 inputs are available.)

HSC input table definitions

- **Single-phase:** C is Clock input, [d] is direction input (optional), and [R] is external reset input (optional)
(Reset is available only for "Counting" mode.)
- **Two-phase:** CU is Clock Up input, CD is Clock Down input, and [R] is external reset input.(optional)
(Reset is available only for "Counting" mode.)
- **AB-phase quadrature:** A is the Clock A input, B is the Clock B input, and [R] is external reset input (optional). (Reset is available only for "Counting" mode.)

Table 9- 7 CPU 1211C: HSC default address assignments

| HSC counter mode | | CPU on-board input (default 0.x) | | | | | | Optional SB input (default 4.x) ¹ | | | |
|------------------|----------|----------------------------------|-----|----|-----|----|-----|--|-----|----|-----|
| | | 0 | 1 | 2 | 3 | 4 | 5 | 0 | 1 | 2 | 3 |
| HSC 1 | 1-phase | C | [d] | | [R] | | | C | [d] | | [R] |
| | 2-phase | CU | CD | | [R] | | | CU | CD | | [R] |
| | AB-phase | A | B | | [R] | | | A | B | | [R] |
| HSC 2 | 1-phase | | [R] | C | [d] | | | | [R] | C | [d] |
| | 2-phase | | [R] | CU | CD | | | | [R] | CU | CD |
| | AB-phase | | [R] | A | B | | | | [R] | A | B |
| HSC 3 | 1-phase | | | | | C | [d] | C | [d] | | R] |
| | 2-phase | | | | | | | | | | |
| | AB-phase | | | | | | | | | | |
| HSC4 | 1-phase | | | | | C | [d] | C | [d] | | R] |
| | 2-phase | | | | | CU | CD | | | | |

| HSC counter mode | | CPU on-board input (default 0.x) | | | | | | Optional SB input (default 4.x) ¹ | | | |
|------------------|----------|----------------------------------|---|---|---|---|---|--|-----|----|-----|
| | | 0 | 1 | 2 | 3 | 4 | 5 | 0 | 1 | 2 | 3 |
| | AB-phase | | | | | A | B | | | | |
| HSC 5 | 1-phase | | | | | | | C | [d] | | [R] |
| | 2-phase | | | | | | | CU | CD | | [R] |
| | AB-phase | | | | | | | A | B | | [R] |
| HSC 6 | 1-phase | | | | | | | | [R] | C | [d] |
| | 2-phase | | | | | | | | [R] | CU | CD |
| | AB-phase | | | | | | | | [R] | A | B |

¹ An SB with only 2 digital inputs provides only the 4.0 and 4.1 inputs.

Table 9- 8 CPU 1212C: HSC default address assignments

| HSC counter mode | | CPU on-board input (default 0.x) | | | | | | | | Optional SB input (default 4.x) ¹ | | | |
|------------------|----------|----------------------------------|-----|----|-----|----|-----|----|-----|--|-----|----|-----|
| | | 0 | 1 | 2 | 3 | 4 | 5 | 6 | 7 | 0 | 1 | 2 | 3 |
| HSC 1 | 1-phase | C | [d] | | [R] | | | | | C | [d] | | [R] |
| | 2-phase | CU | CD | | [R] | | | | | CU | CD | | [R] |
| | AB-phase | A | B | | [R] | | | | | A | B | | [R] |
| HSC 2 | 1-phase | | [R] | C | [d] | | | | | | [R] | C | [d] |
| | 2-phase | | [R] | CU | CD | | | | | | [R] | CU | CD |
| | AB-phase | | [R] | A | B | | | | | | [R] | A | B |
| HSC 3 | 1-phase | | | | | C | [d] | | [R] | C | [d] | | [R] |
| | 2-phase | | | | | CU | CD | | [R] | | | | |
| | AB-phase | | | | | A | B | | [R] | | | | |
| HSC 4 | 1-phase | | | | | | [R] | C | [d] | C | [d] | | [R] |
| | 2-phase | | | | | | [R] | CU | CD | | | | |
| | AB-phase | | | | | | [R] | A | B | | | | |
| HSC 5 | 1-phase | | | | | | | | | C | [d] | | [R] |
| | 2-phase | | | | | | | | | CU | CD | | [R] |
| | AB-phase | | | | | | | | | A | B | | [R] |
| HSC 6 | 1-phase | | | | | | | | | | [R] | C | [d] |
| | 2-phase | | | | | | | | | | [R] | CU | CD |
| | AB-phase | | | | | | | | | | [R] | A | B |

¹ An SB with only 2 digital inputs provides only the 4.0 and 4.1 inputs.

9.1 High-speed counter

Table 9- 9 CPU 1214C, CPU 1215C, and CPU1217C:
HSC default address assignments
(on-board inputs only, see next table for optional SB addresses)

| HSC counter mode | | Digital input byte 0 (default: 0.x) | | | | | | | Digital input byte 1 (default: 1.x) | | | | | | |
|------------------|----------|--|-----|----|-----|----|-----|----|--|----|-----|-----|----|-----|-----|
| | | 0 | 1 | 2 | 3 | 4 | 5 | 6 | 7 | 0 | 1 | 2 | 3 | 4 | 5 |
| HSC 1 | 1-phase | C | [d] | | [R] | | | | | | | | | | |
| | 2-phase | CU | CD | | [R] | | | | | | | | | | |
| | AB-phase | A | B | | [R] | | | | | | | | | | |
| HSC 2 | 1-phase | | [R] | C | [d] | | | | | | | | | | |
| | 2-phase | | [R] | CU | CD | | | | | | | | | | |
| | AB-phase | | [R] | A | B | | | | | | | | | | |
| HSC 3 | 1-phase | | | | | C | [d] | | [R] | | | | | | |
| | 2-phase | | | | | CU | CD | | [R] | | | | | | |
| | AB-phase | | | | | A | B | | [R] | | | | | | |
| HSC 4 | 1-phase | | | | | | [R] | C | [d] | | | | | | |
| | 2-phase | | | | | | [R] | CU | CD | | | | | | |
| | AB-phase | | | | | | [R] | A | B | | | | | | |
| HSC 5 | 1-phase | | | | | | | | | C | [d] | [R] | | | |
| | 2-phase | | | | | | | | | CU | CD | [R] | | | |
| | AB-phase | | | | | | | | | A | B | [R] | | | |
| HSC 6 | 1-phase | | | | | | | | | | | | C | [d] | [R] |
| | 2-phase | | | | | | | | | | | | CU | CD | [R] |
| | AB-phase | | | | | | | | | | | | A | B | [R] |

Table 9- 10 Optional SB in CPUs in above table: HSC default address assignments

| HSC | | Optional SB inputs (default: 4.x) ¹ | | | |
|-------|----------|--|-----|----|-----|
| | | 0 | 1 | 2 | 3 |
| HSC 1 | 1-phase | C | [d] | | [R] |
| | 2-phase | CU | CD | | [R] |
| | AB-phase | A | B | | [R] |
| HSC 2 | 1-phase | | [R] | C | [d] |
| | 2-phase | | [R] | CU | CD |
| | AB-phase | | [R] | A | B |
| HSC 5 | 1-phase | C | [d] | | [R] |
| | 2-phase | CU | CD | | [R] |
| | AB-phase | A | B | | [R] |
| HSC 6 | 1-phase | | [R] | C | [d] |
| | 2-phase | | [R] | CU | CD |
| | AB-phase | | [R] | A | B |

¹ An SB with only 2 digital inputs provides only the 4.0 and 4.1 inputs.

Note

The digital I/O points used by high-speed counter devices are assigned during CPU device configuration. When digital I/O point addresses are assigned to HSC devices, the values of the assigned I/O point addresses cannot be modified by the force function in a watch table.

9.1.2 Configuration of the HSC

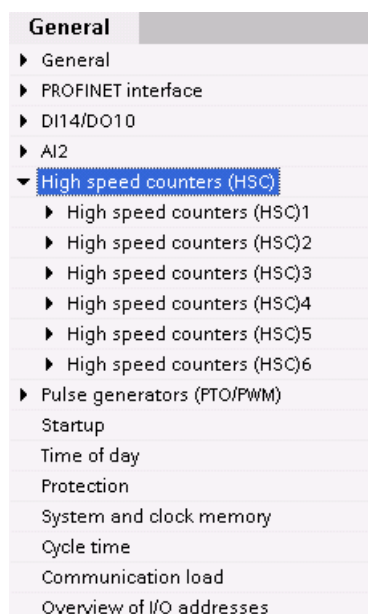

You may configure up to 6 high-speed counters. Edit the CPU device configuration and assign the HSC properties of each individual HSC.

Enable an HSC by selecting the "Enable" option for that HSC

Use the CTRL_HSC instruction in your user program to control the operation of the HSC.



| |
|--|
| <p> WARNING</p> <p>Risks with changes to filter time setting for digital input channels</p> <p>If the filter time for a digital input channel is changed from a previous setting, a new "0" level input value might need to be presented for up to 20.0 ms accumulated duration before the filter becomes fully responsive to new inputs. During this time, short "0" pulse events of duration less than 20.0 ms may not be detected or counted.</p> <p>This changing of filter times can result in unexpected machine or process operation, which can cause death or serious injury to personnel, and/or damage to equipment.</p> <p>To ensure that a new filter time goes immediately into effect, power cycle the CPU.</p> |
|--|

After enabling the HSC, configure the other parameters, such as counter function, initial values, reset options and interrupt events.

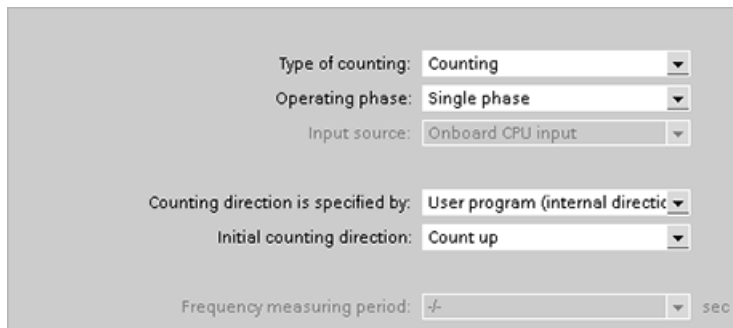

For additional information about configuring the HSC, refer to the section on configuring the CPU (Page 142).

9.2 PID control

STEP 7 provides the following PID instructions for the S7-1200 CPU:

- The PID_Compact instruction is used to control technical processes with continuous input- and output variables.
- The PID_3Step instruction is used to control motor-actuated devices, such as valves that require discrete signals for open- and close actuation.

Note

Changes that you make to the PID configuration and download in RUN do not take effect until the CPU transitions from STOP to RUN mode. Changes that you make in the "PID parameters" dialog using the "Start value control" take effect immediately.

Both PID instructions (PID_3Step and PID_Compact) can calculate the P-, I-, and D-components during startup (if configured for "pre-tuning"). You can also configure the instruction for "fine tuning" to allow you to optimize the parameters. You do not need to manually determine the parameters.

Note

Execute the PID instruction at constant intervals of the sampling time (preferably in a cyclic OB).

Because the PID loop needs a certain time to respond to changes of the control value, do not calculate the output value in every cycle. Do not execute the PID instruction in the main program cycle OB (such as OB 1).

The sampling time of the PID algorithm represents the time between two calculations of the output value (control value). The output value is calculated during self-tuning and rounded to a multiple of the cycle time. All other functions of PID instruction are executed at every call.

PID algorithm

The PID (Proportional/Integral/Derivative) controller measures the time interval between two calls and then evaluates the results for monitoring the sampling time. A mean value of the sampling time is generated at each mode changeover and during initial startup. This value is used as reference for the monitoring function and is used for calculation. Monitoring includes the current measuring time between two calls and the mean value of the defined controller sampling time.

The output value for the PID controller consists of three components:

- P (proportional): When calculated with the "P" component, the output value is proportional to the difference between the setpoint and the process value (input value).
- I (integral): When calculated with the "I" component, the output value increases in proportion to the duration of the difference between the setpoint and the process value (input value) to finally correct the difference.
- D (derivative): When calculated with the "D" component, the output value increases as a function of the increasing rate of change of the difference between the setpoint and the process value (input value). The output value is corrected to the setpoint as quickly as possible.

The PID controller uses the following formula to calculate the output value for the PID_Compact instruction.

$$y = K_p \left[(b \cdot w - x) + \frac{1}{T_i \cdot s} (w - x) + \frac{T_D \cdot s}{a \cdot T_D \cdot s + 1} (c \cdot w - x) \right]$$

| | | | |
|----------------|---|---|--|
| y | Output value | x | Process value |
| w | Setpoint value | s | Laplace operator |
| K _p | Proportional gain (P component) | a | Derivative delay coefficient (D component) |
| T _i | Integral action time (I component) | b | Proportional action weighting (P component) |
| T _D | Derivative action time (D component) | c | Derivative action weighting (D component) |

The PID controller uses the following formula to calculate the output value for the PID_3Step instruction.

$$\Delta y = K_p \cdot s \cdot \left[(b \cdot w - x) + \frac{1}{T_i \cdot s} (w - x) + \frac{T_D \cdot s}{a \cdot T_D \cdot s + 1} (c \cdot w - x) \right]$$

| | | | |
|----------------|---|---|--|
| y | Output value | x | Process value |
| w | Setpoint value | s | Laplace operator |
| K _p | Proportional gain (P component) | a | Derivative delay coefficient (D component) |
| T _i | Integral action time (I component) | b | Proportional action weighting (P component) |
| T _D | Derivative action time (D component) | c | Derivative action weighting (D component) |

9.2.1 Inserting the PID instruction and technology object

STEP 7 provides two instructions for PID control:

- The PID_Compact instruction and its associated technology object provide a universal PID controller with tuning. The technology object contains all of the settings for the control loop.
- The PID_3Step instruction and its associated technology object provide a PID controller with specific settings for motor-activated valves. The technology object contains all of the settings for the control loop. The PID_3Step controller provides two additional Boolean outputs.

After creating the technology object, you must configure the parameters (Page 437). You also adjust the autotuning parameters ("pre-tuning" during startup or manual "fine tuning") to commission the operation of the PID controller (Page 439).

Table 9- 11 Inserting the PID instruction and the technology object

| | |
|---|---|
| <p>When you insert a PID instruction into your user program, STEP 7 automatically creates a technology object and an instance DB for the instruction. The instance DB contains all of the parameters that are used by the PID instruction. Each PID instruction must have its own unique instance DB to operate properly.</p> <p>After inserting the PID instruction and creating the technology object and instance DB, you configure the parameters for the technology object (Page 437).</p> |  |
|---|---|

Table 9- 12 (Optional) Creating a technology object from the project navigator

| | |
|---|--|
| <p>You can also create technology objects for your project before inserting the PID instruction. By creating the technology object before inserting a PID instruction into your user program, you can then select the technology object when you insert the PID instruction.</p> |  |
| <p>To create a technology object, double-click the "Add new object" icon in the project navigator.</p> |  |
| <p>Click the "Control" icon and select the technology object for the type of PID controller (PID_Compact or PID_3Step). You can create an optional name for the technology object.</p> <p>Click "OK" to create the technology object.</p> |  |

9.2.2 PID_Compact instruction

The PID_Compact instruction provides a universal PID controller with integrated self-tuning for automatic and manual mode.

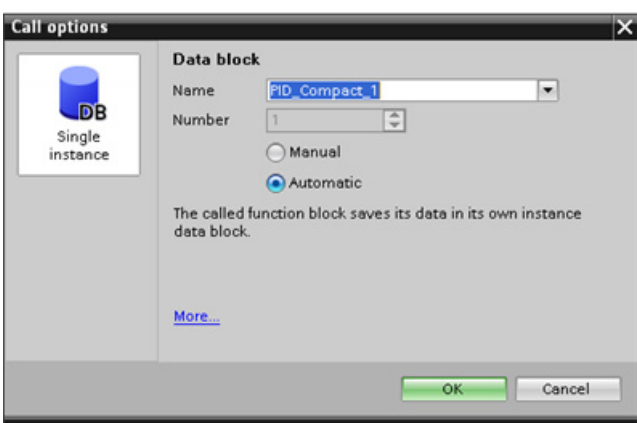
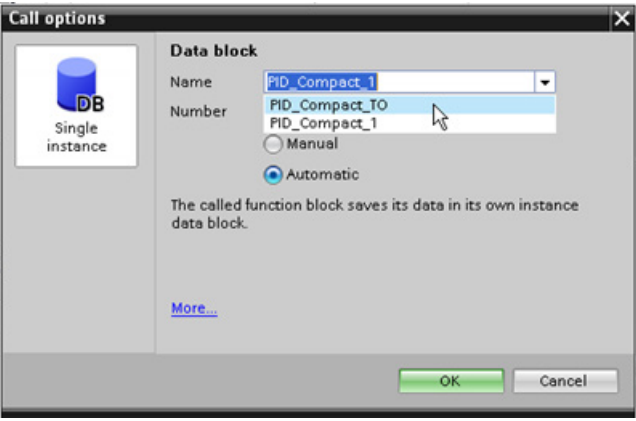
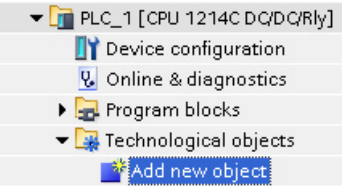
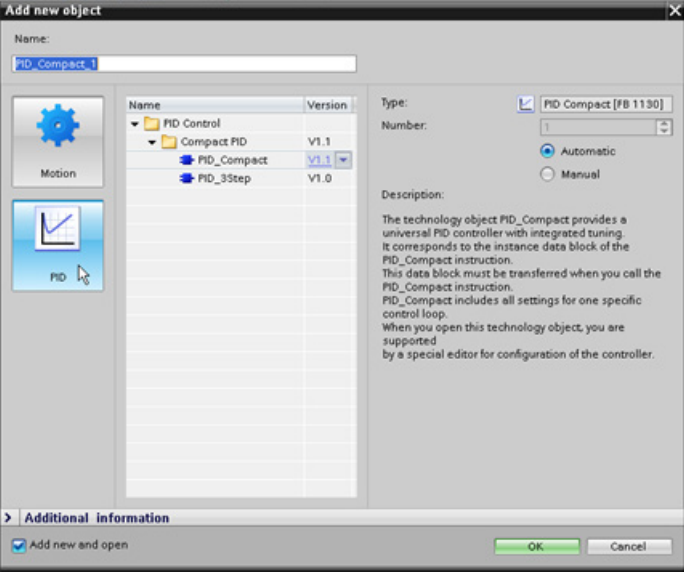
Table 9- 13 PID_Compact instruction

| LAD / FBD | SCL | Description |
|-----------|---|---|
| | <pre>"PID_Compact_1" (Setpoint:=_real_in_, Input:=_real_in_, Input_PER:=_word_in_, Disturbance:=_real_in_, ManualEnable:=_bool_in_, ManualValue:=_real_in_, ErrorAck:=_bool_in_, Reset:=_bool_in_, ModeActivate:=_bool_in_, Mode:=_int_in_, ScaledInput=>_real_out_, Output=>_real_out_, Output_PER=>_word_out_, Output_PWM=>_bool_out_, SetpointLimit_H=>_bool_out_, SetpointLimit_L=>_bool_out_, InputWarning_H=>_bool_out_, InputWarning_L=>_bool_out_, State=>_int_out_, Error=>_bool_out_, ErrorBits=>_dword_out_);</pre> | <p>PID_Compact provides a PID controller with self-tuning for automatic and manual mode. PID_Compact is a PID T1 controller with anti-windup and weighting of the P- and D-component.</p> |

- 1 STEP 7 automatically creates the technology object and instance DB when you insert the instruction. The instance DB contains the parameters of the technology object.
- 2 In the SCL example, "PID_Compact_1" is the name of the instance DB.

Table 9- 14 Data types for the parameters

| Parameter and type | Data type | Description |
|--------------------|-----------|-------------|
| Setpoint | IN | Real |
| Input | IN | Real |
| Input_PER | IN | Word |
| Disturbance | IN | Real |

| Parameter and type | | Data type | Description |
|-------------------------|-----|-----------|---|
| ManualEnable | IN | Bool | <p>Enables or disables the manual operation mode. (Default value: FALSE):</p> <ul style="list-style-type: none"> A FALSE to TRUE edge activates "manual mode", while State = 4, Mode remains unchanged. <p>As long as ManualEnable = TRUE, you cannot change the operating mode using a rising edge at ModeActivate or use the commissioning dialog.</p> <ul style="list-style-type: none"> A TRUE to FALSE edge activates the operating mode that is assigned by Mode. <p>Note: We recommend that you change the operating mode using ModeActivate only.</p> |
| ManualValue | IN | Real | <p>Output value for manual operation. (Default value: 0.0)</p> <p>You can use values from Config.OutputLowerLimit to Config.OutputUpperLimit.</p> |
| ErrorAck | IN | Bool | Resets the ErrorBits and warning outputs. FALSE to TRUE edge |
| Reset | IN | Bool | <p>Restarts the controller. (Default value: FALSE):</p> <ul style="list-style-type: none"> FALSE to TRUE edge: <ul style="list-style-type: none"> Switches to "inactive" mode Resets the ErrorBits and warning outputs Clears Integral action Maintains PID parameters As long as Reset = TRUE, PID_Compact remains in "Inactive" mode (State = 0). TRUE to FALSE edge: <ul style="list-style-type: none"> PID_Compact switches to the operating mode that is saved in the Mode parameter. |
| ModeActivate | IN | Bool | The PID_Compact switches to the operating mode that is saved in the Mode parameter. FALSE to TRUE edge: |
| Mode | IN | Int | The desired PID mode; Activated on the leading edge of the Mode Activate input. |
| ScaledInput | OUT | Real | Scaled process value. (Default value: 0.0) |
| Output ¹ | OUT | Real | Output value in REAL format. (Default value: 0.0) |
| Output_PER ¹ | OUT | Word | Analog output value. (Default value: W#16#0) |
| Output_PWM ¹ | OUT | Bool | <p>Output value for pulse width modulation. (Default value: FALSE)</p> <p>On and Off times form the output value.</p> |
| SetpointLimit_H | OUT | Bool | <p>Setpoint high limit. (Default value: FALSE)</p> <p>If SetpointLimit_H = TRUE, the absolute setpoint upper limit is reached (Setpoint ≥ Config.SetpointUpperLimit).</p> <p>The setpoint is limited to Config.SetpointUpperLimit.</p> |
| SetpointLimit_L | OUT | Bool | <p>Setpoint low limit. (Default value: FALSE)</p> <p>If SetpointLimit_L = TRUE, the absolute setpoint lower limit is reached (Setpoint ≤ Config.SetpointLowerLimit).</p> <p>The setpoint is limited to Config.SetpointLowerLimit.</p> |
| InputWarning_H | OUT | Bool | If InputWarning_H = TRUE, the process value has reached or exceeded the warning high limit. (Default value: FALSE) |

| Parameter and type | | Data type | Description |
|--------------------|-----|-----------|--|
| InputWarning_L | OUT | Bool | If InputWarning_L = TRUE, the process value has reached or fallen below the warning low limit. (Default value: FALSE) |
| State | OUT | Int | Current operating mode of the PID controller. (Default value: 0) You can change the operating mode using the Mode input parameter and a rising edge at ModeActivate: <ul style="list-style-type: none"> • State = 0: Inactive • State = 1: Pre-tuning • State = 2: Manual fine tuning • State = 3: Automatic mode • State = 4: Manual mode • State = 5: Substitute output value with error monitoring |
| Error | OUT | Bool | If Error = TRUE, at least one error message is pending in this cycle. (Default value: FALSE) Note: The Error parameter in V1.x PID was the ErrorBits field that contained the error codes. It is now a Boolean flag indicating that an error has occurred. |
| ErrorBits | OUT | DWord | The PID_Compact instruction ErrorBits parameters table (Page 426) defines the error messages that are pending. (Default value: DW#16#0000 (no error)). ErrorBits is retentive and is reset upon a rising edge at Reset or ErrorAck. Note: In V1.x, the ErrorBits parameter was defined as the Error parameter and did not exist. |

¹ You can use the outputs of the Output, Output_PER, and Output_PWM parameters in parallel.

Operation of the PID_Compact controller

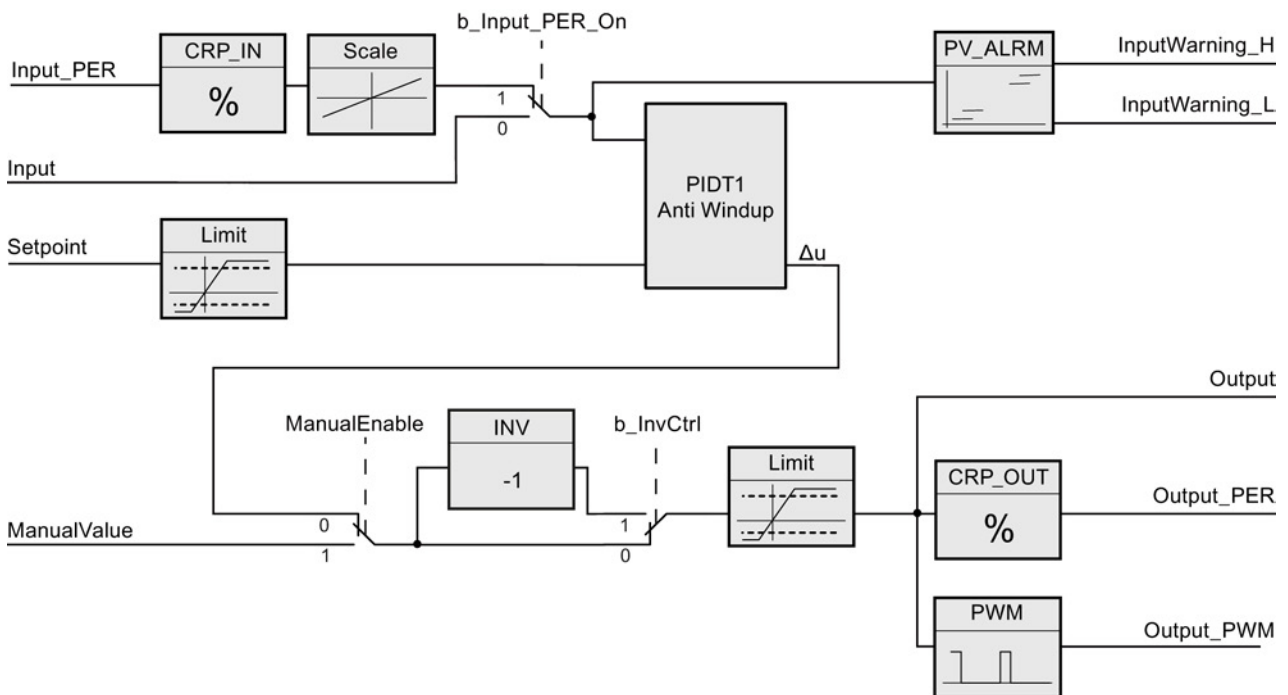

Figure 9-1 Operation of the PID_Compact controller

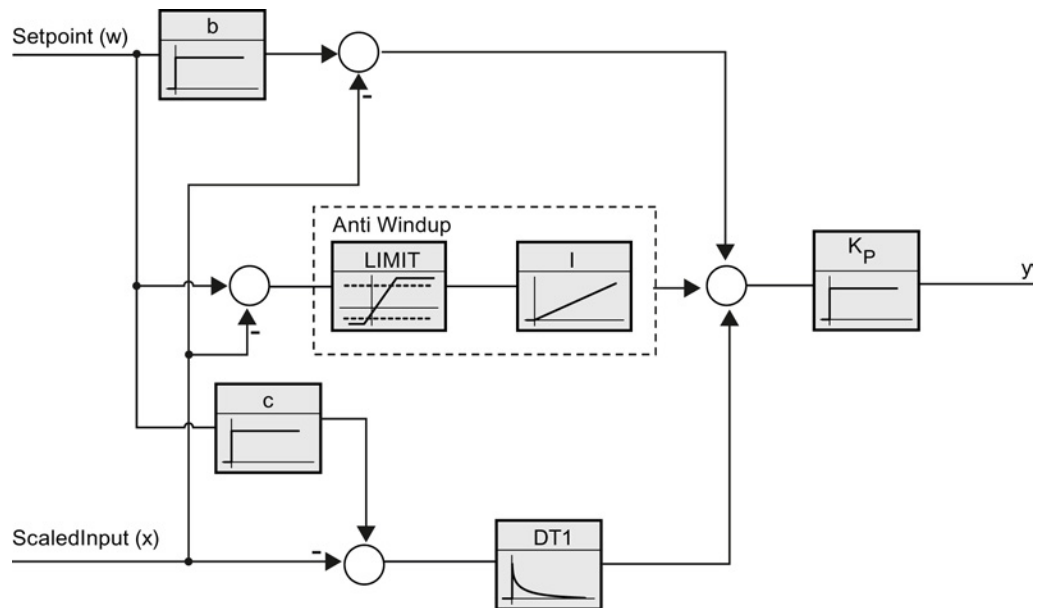

Figure 9-2 Operation of the PID_Compact controller as a PIDD1 controller with anti-windup

9.2.3 PID_Compact instruction ErrorBit parameters

If several errors are pending, the values of the error codes are displayed by means of binary addition. The display of error code 0003, for example, indicates that the errors 0001 and 0002 are also pending.

Table 9- 15 PID_Compact instruction ErrorBit parameters

| ErrorBit (DW#16#...) | Description |
|----------------------|---|
| 0000 | No error |
| 0001 ^{1,2} | The Input parameter is outside the process value limits. Input > Config.InputUpperLimit Input < Config.InputLowerLimit |
| 0002 ^{2,3} | Invalid value at the Input_PER parameter. Check whether an error is pending at the analog input. |
| 0004 ⁴ | Error during fine tuning. Oscillation of the process value could not be maintained. |
| 0008 ⁴ | Error at start of pre-tuning. The process value is too close to the setpoint. Start fine tuning. |
| 0010 ⁴ | The setpoint was changed during tuning. Note: You can set the permitted fluctuation on the setpoint at the CancelTuningLevel tag. |
| 0020 | Pre-tuning is not permitted during fine tuning. Note: If ActivateRecoverMode = TRUE before the error occurred, PID_Compact remains in fine tuning mode. |
| 0080 ⁴ | Error during pre-tuning. Incorrect configuration of output value limits. Check whether the limits of the output value are configured correctly and match the control logic. |
| 0100 ⁴ | Error during fine tuning resulted in invalid parameters. |
| 0200 ^{2,3} | Invalid value at the Input parameter: Value has an invalid number format. |
| 0400 ^{2,3} | Calculation of the output value failed. Check the PID parameters. |
| 0800 ^{1,2} | Sampling time error: PID_Compact is not called within the sampling time of the cyclic interrupt OB. |
| 1000 ^{2,3} | Invalid value at the Setpoint parameter: Value has an invalid number format. |
| 10000 | Invalid value at the ManualValue parameter: Value has an invalid number format. Note: If ActivateRecoverMode = TRUE before the error occurred, PID_Compact uses SubstituteOutput as the output value. As soon as you assign a valid value in the ManualValue parameter, PID_Compact uses it as the output value. |

| ErrorBit (DW#16#...) | Description |
|----------------------|---|
| 20000 | <p>Invalid value at the SubstituteValue tag: Value has an invalid number format.</p> <p>PID_Compact uses the output value low limit as the output value.</p> <p>Note: If automatic mode was active before the error occurred, ActivateRecoverMode = TRUE, and the error is no longer pending, PID_Compact switches back to automatic mode.</p> |
| 40000 | <p>Invalid value at the Disturbance parameter: Value has an invalid number format.</p> <p>Note: If automatic mode was active and ActivateRecoverMode = FALSE before the error occurred, Disturbance is set to zero. PID_Compact remains in automatic mode.</p> <p>Note: If pre-tuning or fine tuning mode was active and ActivateRecoverMode = TRUE before the error occurred, PID_Compact switches to the operating mode that is saved in the Mode parameter. If Disturbance in the current phase has no effect on the output value, tuning is not canceled.</p> |

- ¹ Note: If automatic mode was active before the error occurred and ActivateRecoverMode = TRUE, PID_Compact remains in automatic mode.
- ² Note: If pre-tuning or fine tuning mode was active before the error occurred and ActivateRecoverMode = TRUE, PID_Compact switches to the operating mode that is saved in the Mode parameter.
- ³ Note: If automatic mode was active before the error occurred and ActivateRecoverMode = TRUE, PID_Compact outputs the configured substitute output value. As soon as the error is no longer pending, PID_Compact switches back to automatic mode.
- ⁴ Note: If ActivateRecoverMode = TRUE before the error occurred, PID_Compact cancels the tuning and switches to the operating mode that is saved in the Mode parameter.

9.2.4 PID_3Step instruction

The PID_3Step instruction configures a PID controller with self-tuning capabilities that has been optimized for motor-controlled valves and actuators.

Table 9- 16 PID_3Step instruction

| LAD / FBD | SCL | Description |
|-----------|---|---|
| | <pre>"PID_3Step_1" (SetpoInt:=_real_in_, Input:=_real_in_, ManualValue:=_real_in_, Feedback:=_real_in_, InputPer:=_word_in_, FeedbackPer:=_word_in_, Disturbance:=_real_in_, ManualEnable:=_bool_in_, ManualUP:=_bool_in_, ManualDN:=_bool_in_, ActuatorH:=_bool_in_, ActuatorL:=_bool_in_, ErrorAck:=_bool_in_, Reset:=_bool_in_, ModeActivate:=_bool_in_, Mode:=_int_in_, ScaledInput=>_real_out_, ScaledFeedback=>_real_out_, ErrorBits=>_dword_out_, OutputPer=>_word_out_, State=>_int_out_, OutputUP=>_bool_out_, OutputDN=>_bool_out_, SetpoIntLimitH=>_bool_out_, SetpoIntLimitL=>_bool_out_, InputWarningH=>_bool_out_, InputWarningL=>_bool_out_, Error=>_bool_out_, ErrorBits=>_dword_out_);</pre> | <p>PID_3Step configures a PID controller with self-tuning capabilities that has been optimized for motor-controlled valves and actuators. It provides two Boolean outputs.</p> <p>PID_3Step is a PID T1 controller with anti-windup and weighting of the P- and D-components.</p> |

- 1 STEP 7 automatically creates the technology object and instance DB when you insert the instruction. The instance DB contains the parameters of the technology object.
- 2 In the SCL example, "PID_3Step_1" is the name of the instance DB.

Table 9- 17 Data types for the parameters

| Parameter and type | | Data type | Description |
|--------------------|----|-----------|--|
| Setpoint | IN | Real | Setpoint of the PID controller in automatic mode. (Default value: 0.0) |
| Input | IN | Real | A tag of the user program is used as the source of the process value. (Default value: 0.0) If you are using the Input parameter, you must set Config.InputPerOn = FALSE. |
| Input_PER | IN | Word | An Analog input is used as the source of the process value. (Default value: W#16#0) If you are using the Input_PER parameter, you must set Config.InputPerOn = TRUE. |
| Actuator_H | IN | Bool | Digital position feedback of the valve for the high end stop If Actuator_H = TRUE, the valve is at the high end stop and is no longer moved in this direction. (Default value: FALSE) |
| Actuator_L | IN | Bool | Digital position feedback of the valve for the low end stop If Actuator_L = TRUE, the valve is at the low end stop and is no longer moved in this direction. (Default value: FALSE) |
| Feedback | IN | Real | Position feedback of the valve. (Default value: 0.0) If you are using the Feedback parameter, you must set Config.FeedbackPerOn = FALSE. |
| Feedback_PER | IN | Int | Analog feedback of the valve position. (Default value: W#16#0) If you are using the Feedback_PER parameter, you must set Config.FeedbackPerOn = TRUE. Feedback_PER is scaled, based upon the following tags: <ul style="list-style-type: none"> Config.FeedbackScaling.LowerPointIn Config.FeedbackScaling.UpperPointIn Config.FeedbackScaling.LowerPointOut Config.FeedbackScaling.UpperPointOut |
| Disturbance | IN | Real | Disturbance variable or pre-control value |
| ManualEnable | IN | Bool | Enables or disables the manual operation mode. (Default value: FALSE): <ul style="list-style-type: none"> A FALSE to TRUE edge activates "manual mode", while State = 4, Mode remains unchanged. As long as ManualEnable = TRUE, you cannot change the operating mode using a rising edge at ModeActivate or use the commissioning dialog. <ul style="list-style-type: none"> A TRUE to FALSE edge activates the operating mode that is assigned by Mode. Note: We recommend that you change the operating mode using ModeActivate only. |
| ManualValue | IN | Real | Process value for manual operation. (Default value: 0.0) In manual mode, you specify the absolute position of the valve. ManualValue is evaluated only if you are using OutputPer, or if position feedback is available. |

| Parameter and type | | Data type | Description |
|--------------------|-----|-----------|--|
| ManualUP | IN | Bool | <ul style="list-style-type: none"> Manual_UP = TRUE: <ul style="list-style-type: none"> The valve is opened even if you use Output_PER or a position feedback. The valve is no longer moved if the high end stop has been reached. See also Config.VirtualActuatorLimit Manual_UP = FALSE: <ul style="list-style-type: none"> If you use Output_PER or a position feedback, the valve is moved to ManualValue. Otherwise, the valve is no longer moved. <p>Note: If Manual_UP and Manual_DN are set to TRUE simultaneously, the valve is not moved.</p> |
| ManualDN | IN | Bool | <ul style="list-style-type: none"> Manual_DN = TRUE: <ul style="list-style-type: none"> The valve is opened even if you use Output_PER or a position feedback. The valve is no longer moved if the high end stop has been reached. See also Config.VirtualActuatorLimit Manual_DN = FALSE: <ul style="list-style-type: none"> If you use Output_PER or a position feedback, the valve is moved to ManualValue. Otherwise, the valve is no longer moved. |
| ErrorAck | IN | Bool | Resets the ErrorBits and warning outputs. FALSE to TRUE edge |
| Reset | IN | Bool | <p>Restarts the controller. (Default value: FALSE):</p> <ul style="list-style-type: none"> FALSE to TRUE edge: <ul style="list-style-type: none"> Switches to "inactive" mode Resets the ErrorBits and warning outputs Clears Integral action Maintains PID parameters As long as Reset = TRUE, PID_3Step remains in "Inactive" mode (State = 0). TRUE to FALSE edge: <ul style="list-style-type: none"> PID_3Step switches to the operating mode that is saved in the Mode parameter. |
| ModeActivate | IN | Bool | The PID_3Step switches to the mode that is saved in the Mode parameter. FALSE to TRUE edge: |
| Mode | IN | Int | The desired PID mode; Activated on the leading edge of the Mode Activate input. |
| ScaledInput | OUT | Real | Scaled process value |
| ScaledFeedback | OUT | Real | <p>Scaled valve position feedback</p> <p>Note: For an actuator without position feedback, the position of the actuator indicated by ScaledFeedback is very imprecise. ScaledFeedback can only be used for rough estimation of the current position in this case.</p> |
| Output_UP | OUT | Bool | <p>Digital output value for opening the valve. (Default value: FALSE)</p> <p>If Config.OutputPerOn = FALSE, the parameter Output_UP is used.</p> |

| Parameter and type | | Data type | Description |
|--------------------|-----|-----------|--|
| Output_DN | OUT | Bool | Digital output value for closing the valve. (Default value: FALSE) If Config.OutputPerOn = FALSE, the parameter Output_DN is used. |
| Output_PER | OUT | Word | Analog output value. If Config.OutputPerOn = TRUE, the parameter Output_PER is used. |
| SetpointLimitH | OUT | Bool | Setpoint high limit. (Default value: FALSE) If SetpointLimitH = TRUE, the absolute upper limit of the setpoint is reached (Setpoint \geq Config.SetpointUpperLimit). Note: The setpoint is limited to (Setpoint \geq Config.SetpointUpperLimit). |
| SetpointLimitL | OUT | Bool | Setpoint low limit. (Default value: FALSE) If SetpointLimitL = TRUE, the absolute lower limit of the setpoint is reached (Setpoint \geq Config.SetpointLowerLimit). Note: The setpoint is limited to (Setpoint \geq Config.SetpointLowerLimit). |
| InputWarningH | OUT | Bool | If InputWarningH = TRUE, the input value has reached or exceeded the warning high limit. (Default value: FALSE) |
| InputWarningL | OUT | Bool | If InputWarningL = TRUE, the input value has reached or exceeded the warning low limit. (Default value: FALSE) |
| State | OUT | Int | Current operating mode of the PID controller. (Default value: 0) You can change the operating mode using the Mode input parameter and a rising edge at ModeActivate: <ul style="list-style-type: none"> • State = 0: Inactive • State = 1: Pre-tuning • State = 2: Manual fine tuning • State = 3: Automatic mode • State = 4: Manual mode • State = 5: Substitute output value approach • State = 6: Transition time measurement • State = 7: Error monitoring • State = 8: Substitute output value approach with error monitoring\ • State = 10: Manual mode without end stop signals |
| Error | OUT | Bool | If Error = TRUE, at least one error message is pending. (Default value: FALSE) Note: The Error parameter in V1.x PID was the ErrorBits field that contained the error codes. It is now a Boolean flag indicating that an error has occurred. |
| ErrorBits | OUT | DWord | The PID_3Step instruction ErrorBits parameters table (Page 435) defines the error messages that are pending. (Default value: DW#16#0000 (no error)). ErrorBits is retentive and is reset upon a rising edge at Reset or ErrorAck. Note: In V1.x, the ErrorBits parameter was defined as the Error parameter and did not exist. |

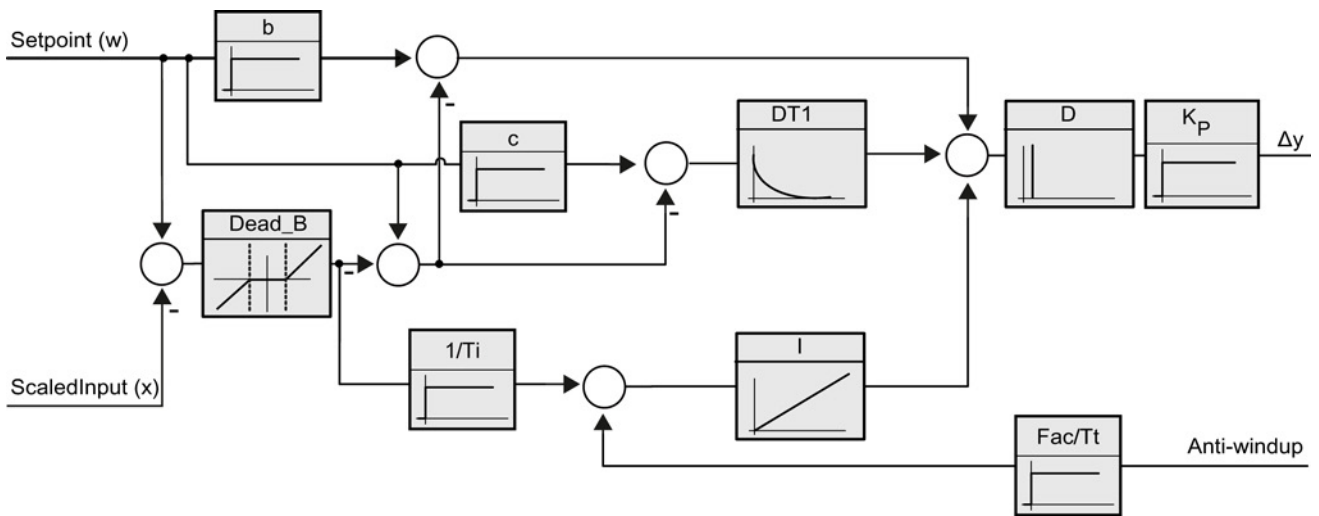

Figure 9-3 Operation of the PID_3Step controller as a PID T1 controller with anti-windup

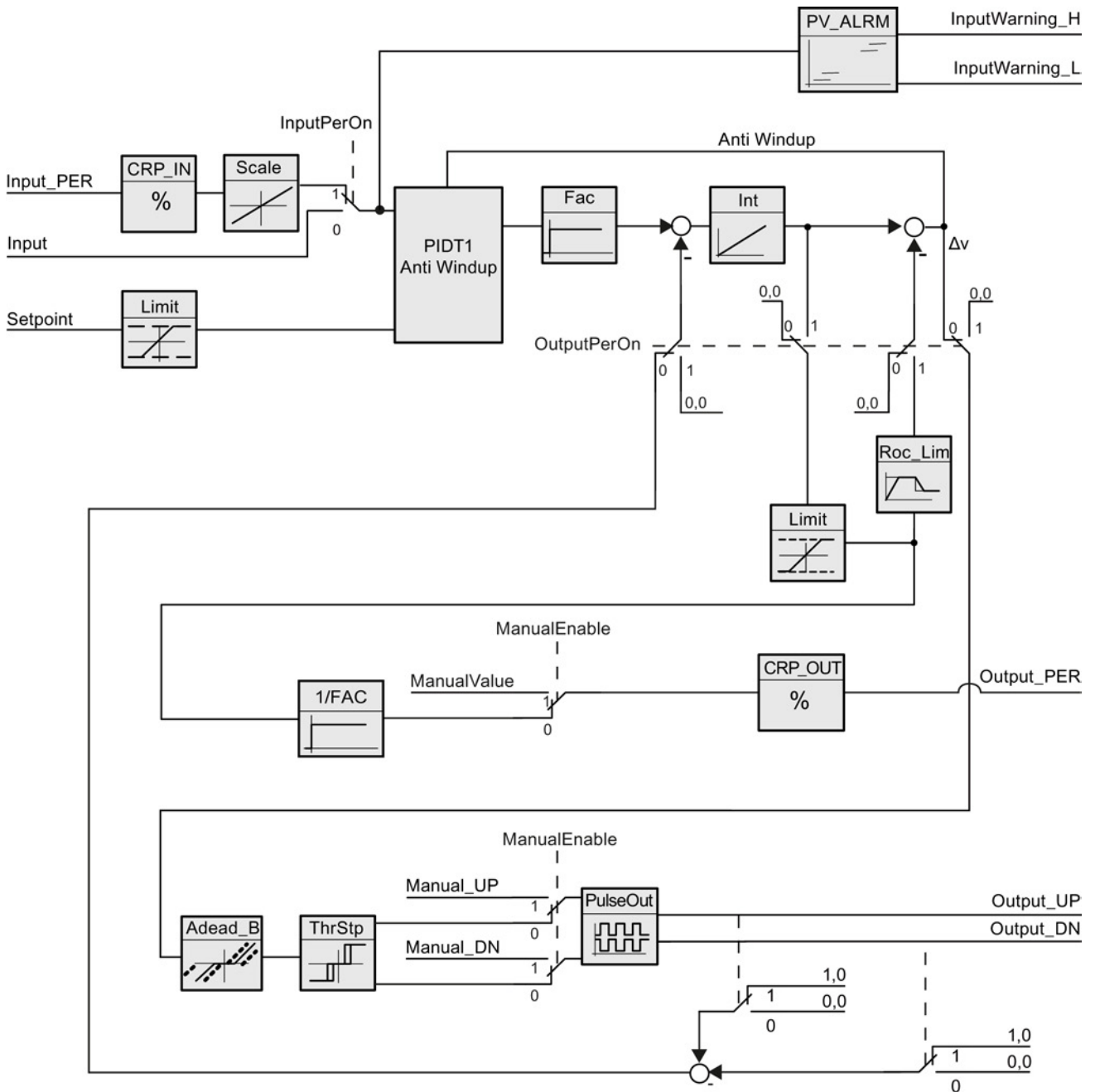

Figure 9-4 Operation of the PID_3Step controller without position feedback

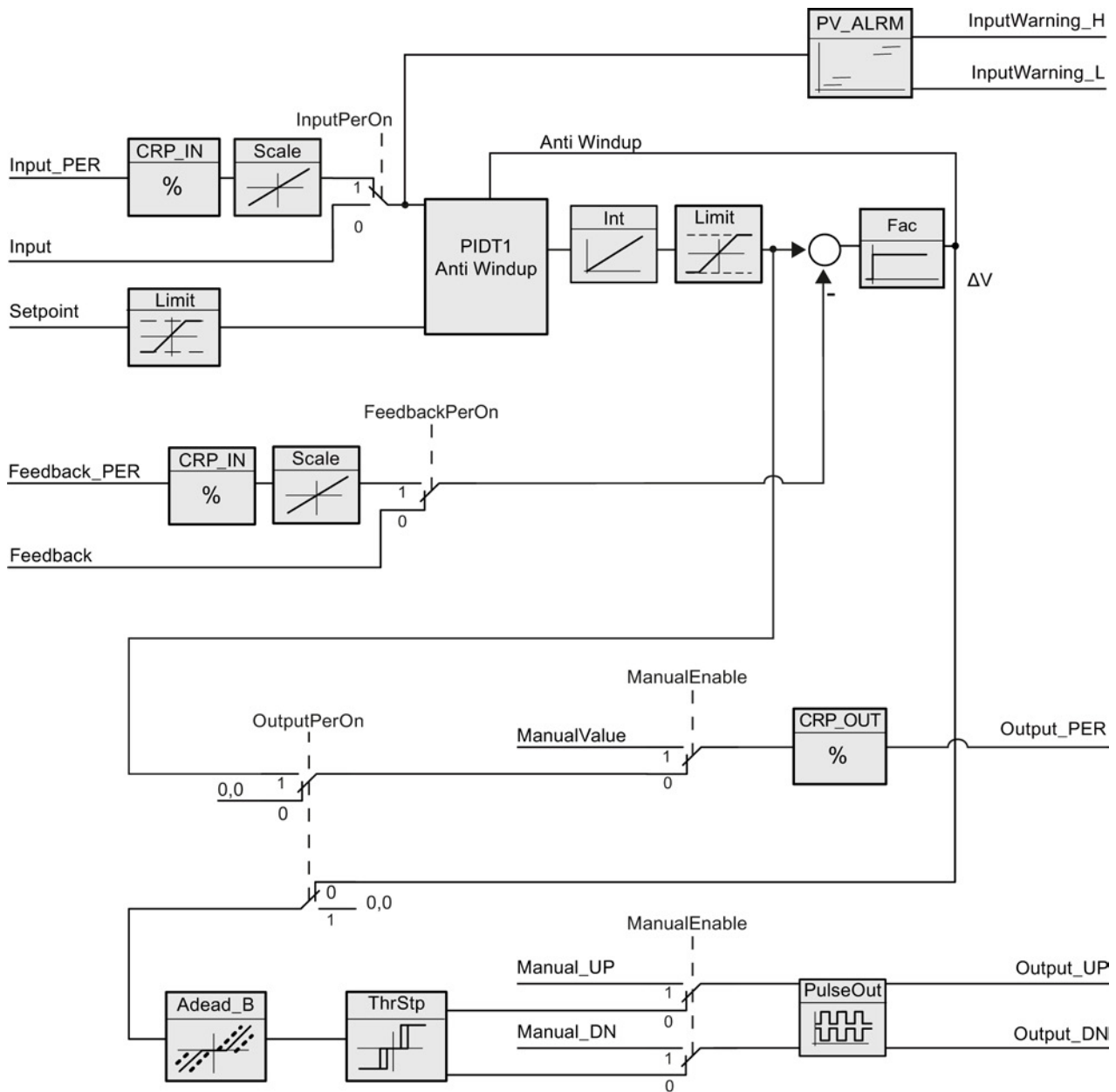

Figure 9-5 Operation of the PID_3Step controller with position feedback enabled

9.2.5 PID_3Step instruction ErrorBit parameters

If several errors are pending, the values of the error codes are displayed by means of binary addition. The display of error code 0003, for example, indicates that the errors 0001 and 0002 are also pending.

Table 9- 18 PID_3STEP instruction ErrorBit parameters

| ErrorBit (DW#16#...) | Description |
|-----------------------|---|
| 0000 | No error |
| 0001 ^{1,2} | The Input parameter is outside the process value limits. Input > Config.InputUpperLimit Input < Config.InputLowerLimit |
| 0002 ^{2,3} | Invalid value at the Input_PER parameter. Check whether an error is pending at the analog input. |
| 0004 ⁴ | Error during fine tuning. Oscillation of the process value could not be maintained. |
| 0010 ⁴ | The setpoint was changed during tuning. Note: You can set the permitted fluctuation on the setpoint at the CancelTuningLevel tag. |
| 0020 | Pre-tuning is not permitted during fine tuning. Note: If ActivateRecoverMode = TRUE before the error occurred, PID_3Step remains in fine tuning mode. |
| 0080 ⁴ | Error during pre-tuning. Incorrect configuration of output value limits. Check whether the limits of the output value are configured correctly and match the control logic. |
| 0100 ⁴ | Error during fine tuning resulted in invalid parameters. |
| 0200 ^{2,3} | Invalid value at the Input parameter: Value has an invalid number format. |
| 0400 ^{2,3} | Calculating the output value failed. Check the PID parameters. |
| 0800 ^{1,2} | Sampling time error: PID_3Step is not called within the sampling time of the cyclic interrupt OB. |
| 1000 ^{2,3} | Invalid value at the Setpoint parameter: Value has an invalid number format. |
| 2000 ^{1,2,5} | Invalid value at the Feedback_PER parameter. Check whether an error is pending at the analog input. |
| 4000 ^{1,2,5} | Invalid value at the Feedback parameter: Value has an invalid number format. |
| 8000 ^{1,2} | Error during digital position feedback. Actuator_H = TRUE and Actuator_L = TRUE. The actuator cannot be moved to the substitute output value and remains in its current position. Manual mode is not possible in this state. In order to move the actuator from this state, you must deactivate the "Actuator end stop" (Config.ActuatorEndStopOn = FALSE) or switch to manual mode without end stop signals (Mode = 10). |

| ErrorBit (DW#16#...) | Description |
|----------------------|--|
| 10000 | <p>Invalid value at the ManualValue parameter: Value has an invalid number format.</p> <p>The actuator cannot be moved to the manual value and remains in its current position.</p> <p>Assign a valid value in ManualValue or move the actuator in manual mode with Manual_UP and Manual_DN.</p> |
| 20000 | <p>Invalid value at the SavePosition tag: Value has an invalid number format.</p> <p>The actuator cannot be moved to the substitute output value and remains in its current position.</p> |
| 40000 | <p>Invalid value at the Disturbance parameter: Value has an invalid number format.</p> <p>Note: If automatic mode was active and ActivateRecoverMode = FALSE before the error occurred, Disturbance is set to zero. PID_3Step remains in automatic mode.</p> <p>Note: If pre-tuning or fine tuning mode was active and ActivateRecoverMode = TRUE before the error occurred, PID_3Step switches to the operating mode that is saved in the Mode parameter. If Disturbance in the current phase has no effect on the output value, tuning is not canceled.</p> <p>The error has no effect during transition time measurement.</p> |

- 1 Note: If automatic mode was active before the error occurred and ActivateRecoverMode = TRUE, PID_3Step remains in automatic mode.
- 2 Note: If pre-tuning, fine tuning, or transition time measurement mode were active and ActivateRecoverMode = TRUE before the error occurred, PID_3Step switches to the operating mode that is saved in the Mode parameter.
- 3 Note: If automatic mode was active before the error occurred and ActivateRecoverMode = TRUE, PID_3Step switches to "Approach substitute output value with error monitoring" or "Error monitoring" mode. As soon as the error is no longer pending, PID_3Step switches back to automatic mode.
- 4 Note: If ActivateRecoverMode = TRUE before the error occurred, PID_3Step cancels the tuning and switches to the operating mode that is saved in the Mode parameter.
- 5 The actuator cannot be moved to the substitute output value and remains in its current position. In manual mode, you can change the position of the actuator only with Manual_UP and Manual_DN, and not with ManualValue.

9.2.6 Configuring the PID controller

The parameters of the technology object determine the operation of the PID controller. Use the icon to open the configuration editor.

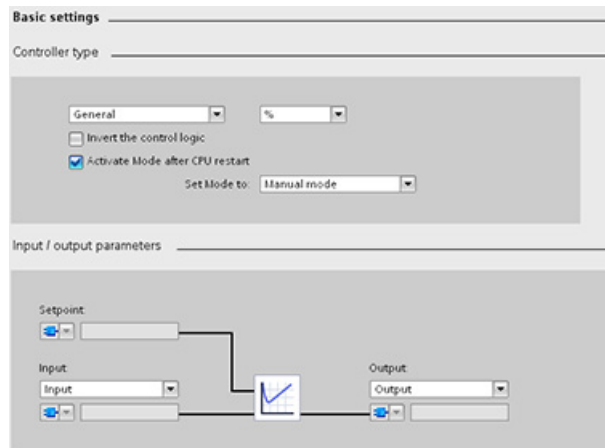

Table 9- 19 Sample configuration settings for the PID_Compact instruction

| Settings | Description | |
|---------------|--|---|
| Basic | Controller type | Selects the engineering units. |
| | Invert the control logic | Allows selection of a reverse-acting PID loop. <ul style="list-style-type: none"> If not selected, the PID loop is in direct-acting mode and the output of PID loop increases if input value < setpoint. If selected, the output of the PID loop increases if the input value > setpoint. |
| | Enable last mode after CPU restart | Restarts the PID loop after it is reset or if an input limit has been exceeded and returned to the valid range. |
| | Input | Selects either the Input parameter or the Input_PER parameter (for analog) for the process value. Input_PER can come directly from an analog input module. |
| | Output | Selects either the Output parameter or the Output_PER parameter (for analog) for the output value. Output_PER can go directly to an analog output module. |
| Process value | Scales both the range and the limits for the process value. If the process value goes below the low limit or above the high limit, the PID loop goes to inactive mode and sets the output value to 0. To use Input_PER, you must scale the analog process value (input value). | |

9.2 PID control

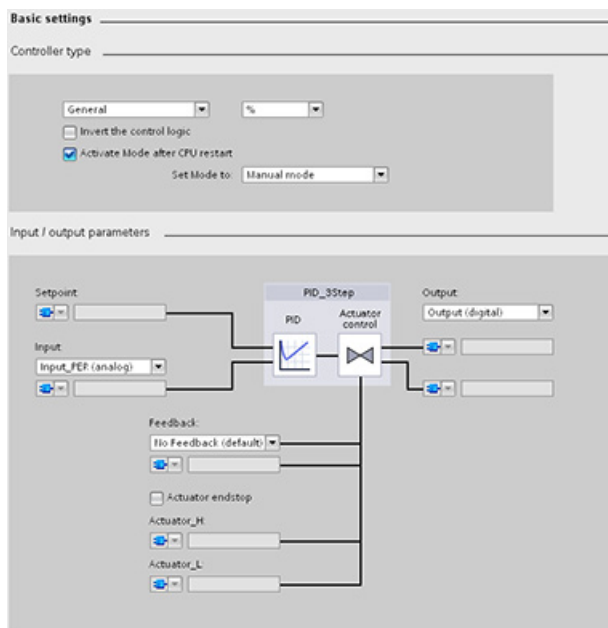

Table 9- 20 Sample configuration settings for the PID_3Step instruction

| Settings | | Description |
|---------------|--|---|
| Basic | Controller type | Selects the engineering units. |
| | Invert the control logic | Allows selection of a reverse-acting PID loop. <ul style="list-style-type: none"> If not selected, the PID loop is in direct-acting mode, and the output of PID loop increases if the input value < setpoint). If selected, the output of the PID loop increases if the input value > setpoint. |
| | Activate mode after CPU restart | Restarts the PID loop after it is reset or if an input limit has been exceeded and returned to the valid range. Set Mode to: Defines the mode that the user wants the PID to go to after restart. |
| | Input | Selects either the Input parameter or the Input_PER parameter (for analog) for the process value. Input_PER can come directly from an analog input module. |
| | Output | Selects either to use the digital outputs (Output_UP and Output_DN) or to use the analog output (Output_PER) for the output value. |
| | Feedback | Selects the type of device status returned to the PID loop: <ul style="list-style-type: none"> No feedback (default) Feedback Feedback_PER |
| Process value | Scales both the range and the limits for the process value. If the process value goes below the low limit or above the high limit, the PID loop goes to inactive mode and sets the output value to 0. To use Input_PER, you must scale the analog process value (input value). | |
| Actuator | Motor transition time | Sets the time from open to close for the valve. (Locate this value on the data sheet or the faceplate of the valve.) |
| | Minimum ON time | Sets the minimum movement time for the valve. (Locate this value on the data sheet or the faceplate of the valve.) |
| | Minimum OFF time | Sets the minimum pause time for the valve. (Locate this value on the data sheet or the faceplate of the valve.) |

| Settings | | Description |
|----------|--------------------------------------|---|
| | Reaction to error | Defines the behavior of the valve when an error is detected or when the PID loop is reset. If you select to use a substitute position, enter the "Safety position". For analog feedback or analog output, select a value between the upper or lower limit for the output. For digital outputs, you can choose only 0% (off) or 100% (on). |
| | Scale Position Feedback ¹ | <ul style="list-style-type: none"> "High end stop" and "Lower end stop" define the maximum positive position (full-open) and the maximum negative position (full-closed). "High end stop" must be greater than "Lower end stop". "High limit process value" and "Low limit process value" define the upper and lower positions of the valve during tuning and automatic mode. "FeedbackPER" ("Low" and "High") defines the analog feedback of the valve position. "FeedbackPER High" must be greater than "FeedbackPER Low". |
| Advanced | Monitoring process value | Sets the warning high and low limits for the process value. |
| | PID parameters | If the user wishes, he can enter his own PID tuning parameters in this window. The "Enable Manual Entry" check box must be checked to allow this. |

¹ "Scale Position Feedback" is editable only if you enabled "Feedback" in the "Basic" settings.

9.2.7 Commissioning the PID controller

Use the commissioning editor to configure the PID controller for autotuning at startup and for autotuning during operation. To open the commissioning editor, click the icon on either the instruction or the project navigator.



Table 9- 21 Sample commissioning screen (PID_3Step)

| | |
|--|---|
| | <ul style="list-style-type: none"> Measurement: To display the setpoint, the process value (input value) and the output value in a real-time trend, enter the sample time and click the "Start" button. Tuning mode: To tune the PID loop, select either "Pre-tuning" or "Fine tuning" (manual) and click the "Start" button. The PID controller runs through multiple phases to calculate system response and update times. The appropriate tuning parameters are calculated from these values. <p>After the completion of the tuning process, you can store the new parameters by clicking the "Upload PID parameters" button in the "PID Parameters" section of the commissioning editor.</p> <p>If an error occurs during tuning, the output value of the PID goes to 0. The PID mode then is set to "inactive" mode. The status indicates the error.</p> |
|--|---|

PID start value control

You can edit the actual values of the PID configuration parameters so that the behavior of the PID controller can be optimized in online mode.

Open the "Technology objects" for your PID controller and its "Configuration" object. To access the start value control, click the "eyeglasses icon" in the upper left corner of the dialog:

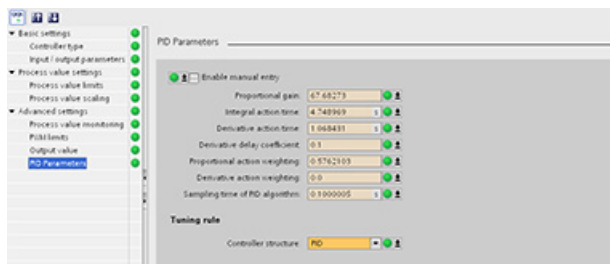

You can now change the value of any of your PID controller configuration parameters as shown in the figure below.

You can compare the actual value to the project (offline) start value and the PLC (online) start value of each parameter. This is necessary to compare online/offline differences of the Technology object data block (TO-DB) and to be informed about the values that will be used as current values on the next Stop-to-Start transition of the PLC. In addition, a compare icon gives a visual indication to help easily identify online/offline differences:

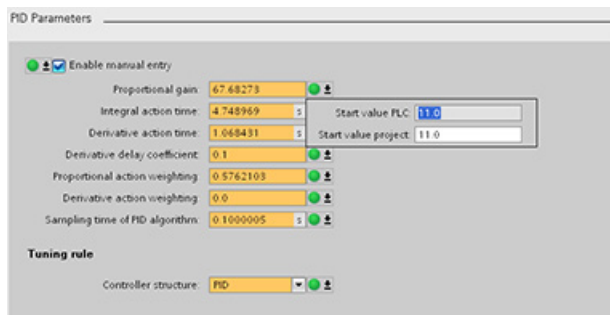

The figure above shows the PID parameter screen with compare icons showing which values are different between online and offline projects. A green icon indicates that the values are the same; a blue/orange icon indicates that the values are different.

Additionally, click the parameter button with the downward arrow to open a small window that shows the project (offline) start value and the PLC (online) start value of each parameter:

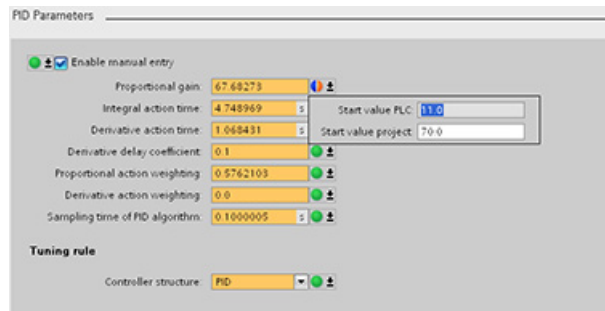

9.3 Motion control

The CPU provides motion control functionality for the operation of stepper motors and servo motors with pulse interface. The motion control functionality takes over the control and monitoring of the drives.

- The "Axis" technology object configures the mechanical drive data, drive interface, dynamic parameters, and other drive properties.
- You configure the pulse and direction outputs of the CPU for controlling the drive.
- Your user program uses the motion control instructions to control the axis and to initiate motion tasks.
- Use the PROFINET interface to establish the online connection between the CPU and the programming device. In addition to the online functions of the CPU, additional commissioning and diagnostic functions are available for motion control.

Note

Changes that you make to the motion control configuration and download in RUN mode do not take effect until the CPU transitions from STOP to RUN mode.

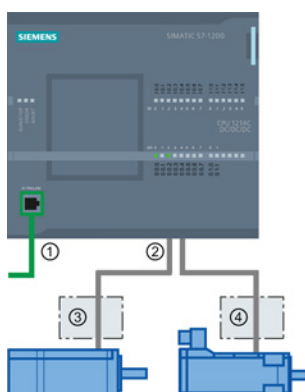

- ① PROFINET
- ② Pulse and direction outputs
- ③ Power section for stepper motor
- ④ Power section for servo motor

The DC/DC/DC variants of the CPU S7-1200 have onboard outputs for direct control of drives. The relay variants of the CPU require the signal board with DC outputs for drive control.

A signal board (SB) expands the onboard I/O to include a few additional I/O points. An SB with two digital outputs can be used as pulse and direction outputs to control one motor. An SB with four digital outputs can be used as pulse and direction outputs to control two motors. Built-in relay outputs cannot be used as pulse outputs to control motors. Whether you use onboard I/O or SB I/O or a combination of both, you can have a maximum number of four pulse generators.

The four pulse generators have default I/O assignments; however, they can be configured to any digital output on the CPU or SB. Pulse generators on the CPU cannot be assigned to SMs or to distributed I/O.

Note

Pulse-train outputs cannot be used by other instructions in the user program

When you configure the outputs of the CPU or signal board as pulse generators (for use with the PWM or motion control instructions), the corresponding output addresses no longer control the outputs. If your user program writes a value to an output used as a pulse generator, the CPU does not write that value to the physical output.

Table 9- 22 Maximum number of controllable drives

| Type of CPU | | Onboard I/O; No SB installed | | With an SB (2 x DC outputs) | | With an SB (4 x DC outputs) | |
|-------------|-----------|---------------------------------|-------------------|--------------------------------|-------------------|--------------------------------|-------------------|
| | | With direction | Without direction | With direction | Without direction | With direction | Without direction |
| CPU 1211C | DC/DC/DC | 2 | 4 | 3 | 4 | 4 | 4 |
| | AC/DC/RLY | 0 | 0 | 1 | 2 | 2 | 4 |
| | DC/DC/RLY | 0 | 0 | 1 | 2 | 2 | 4 |
| CPU 1212C | DC/DC/DC | 3 | 4 | 3 | 4 | 4 | 4 |
| | AC/DC/RLY | 0 | 0 | 1 | 2 | 2 | 4 |
| | DC/DC/RLY | 0 | 0 | 1 | 2 | 2 | 4 |
| CPU 1214C | DC/DC/DC | 4 | 4 | 4 | 4 | 4 | 4 |
| | AC/DC/RLY | 0 | 0 | 1 | 2 | 2 | 4 |

| Type of CPU | | Onboard I/O; No SB installed | | With an SB (2 x DC outputs) | | With an SB (4 x DC outputs) | |
|-------------|-----------|---------------------------------|----------------------|--------------------------------|----------------------|--------------------------------|----------------------|
| | | With direction | Without direction | With direction | Without direction | With direction | Without direction |
| | DC/DC/RLY | 0 | 0 | 1 | 2 | 2 | 4 |
| CPU 1215C | DC/DC/DC | 4 | 4 | 4 | 4 | 4 | 4 |
| | AC/DC/RLY | 0 | 0 | 1 | 2 | 2 | 4 |
| | DC/DC/RLY | 0 | 0 | 1 | 2 | 2 | 4 |
| CPU 1217C | DC/DC/DC | 4 | 4 | 4 | 4 | 4 | 4 |

Note

The maximum number of pulse generators is four.

Whether you use onboard I/O, SB I/O, or a combination of both, you can have a maximum number of four pulse generators.

Table 9- 23 CPU output: maximum frequency

| CPU | CPU output channel | Pulse and direction output | A/B, quadrature, up/down, and pulse/direction |
|-----------------|--|-------------------------------|--|
| 1211C | Qa.0 to Qa.3 | 100 kHz | 100 kHz |
| 1212C | Qa.0 to Qa.3 | 100 kHz | 100 kHz |
| | Qa.4, Qa.5 | 20 kHz | 20 kHz |
| 1214C and 1215C | Qa.0 to Qa.3 | 100kHz | 100kHz |
| | Qa.4 to Qb.1 | 20 kHz | 20 kHz |
| 1217C | DQa.0 to DQa.3 (.0+, .0- to .3+, .3-) | 1 MHz | 1 MHz |
| | DQa.4 to DQb.1 | 100 kHz | 100 kHz |

Table 9- 24 SB signal board output: maximum frequency (optional board)

| SB signal board | SB output channel | Pulse and direction output | A/B, quadrature, up/down, and pulse/direction |
|------------------|-------------------|-------------------------------|--|
| SB 1222, 200 kHz | DQe.0 to DQe.3 | 200kHz | 200 kHz |
| SB 1223, 200 kHz | DQe.0, DQe.1 | 200kHz | 200 kHz |
| SB 1223 | DQe.0, DQe.1 | 20 kHz | 20 kHz |

Table 9- 25 Limit frequencies of pulse outputs

| Pulse output | Frequency |
|----------------|---|
| Onboard | 4 PTO: $2 \text{ Hz} \leq f \leq 1 \text{ MHz}$, 4 PTO: $2 \text{ Hz} \leq f \leq 100 \text{ KHz}$, or any combination of these values for 4 PTOs. ^{1,2} |
| Standard SB | $2 \text{ Hz} \leq f \leq 20 \text{ KHz}$ |
| High-speed SBs | $2 \text{ Hz} \leq f \leq 200 \text{ KHz}$ |

¹ See the table below for four possible CPU 1217C output speed combinations.

² See the table below for four possible CPU 1211C, CPU 1212C, CPU 1214C, or CPU 1215C output speed combinations.

CPU 1217C example output speed configurations

Note

The CPU 1217C can generate pulse outputs up to 1 MHz, using the onboard differential outputs.

The examples below show four possible output speed combinations:

- Example 1: 4 - 1 MHz PTOs, no direction output
- Example 2: 1 - 1 MHz, 2 - 100 KHz, and 1 - 20 KHz PTOs, all with direction output
- Example 3: 4 - 200 KHz PTOs, no direction output
- Example 4: 2 - 100 KHz PTOs and 2 - 200 KHz PTOs, all with direction output

| P = Pulse D = Direction | CPU on-board outputs | | | | | | | | | | | High-speed SB outputs | | | | Standard SB outputs | |
|--|----------------------|------|------|------|---------------------|-----|-----|-----|-----|-----|-----|-----------------------|-----|-----|-----|---------------------|--|
| | 1 MHz Outputs (Q) | | | | 100 KHz Outputs (Q) | | | | | | | 200 KHz Outputs (Q) | | | | 20 KHz Outputs (Q) | |
| | 0.0+ | 0.1+ | 0.2+ | 0.3+ | 0.4 | 0.5 | 0.6 | 0.7 | 1.0 | 1.1 | 4.0 | 4.1 | 4.2 | 4.3 | 4.0 | 4.1 | |
| | 0.0- | 0.1- | 0.2- | 0.3- | | | | | | | | | | | | | |
| Ex. 1: 4 - 1 MHz (no direction output) | PTO1 | P | | | | | | | | | | | | | | | |
| | PTO2 | | P | | | | | | | | | | | | | | |
| | PTO3 | | | P | | | | | | | | | | | | | |
| | PTO4 | | | | P | | | | | | | | | | | | |
| Ex. 2: 1 - 1 MHz; 2 - 100 and 1 - 20 KHz (all with direction output) | PTO1 | P | D | | | | | | | | | | | | | | |
| | PTO2 | | | | | P | D | | | | | | | | | | |
| | PTO3 | | | | | | | P | D | | | | | | | | |
| | PTO4 | | | | | | | | | | | | | | P | D | |

| P = Pulse D = Direction | CPU on-board outputs | | | | | | | | | | | High-speed SB outputs | | | | Standard SB outputs | |
|--|----------------------|------|------|------|------|------|------|------|------|-------|-------|-----------------------|-------|-------|-------|---------------------|--|
| | PTO1 | PTO2 | PTO3 | PTO4 | PTO5 | PTO6 | PTO7 | PTO8 | PTO9 | PTO10 | PTO11 | PTO12 | PTO13 | PTO14 | PTO15 | PTO16 | |
| Ex. 3: 4 - 200 KHz (no direction output) | PTO1 | | | | | | | | | | | | P | | | | |
| | PTO2 | | | | | | | | | | | | | P | | | |
| | PTO3 | | | | | | | | | | | | | | P | | |
| | PTO4 | | | | | | | | | | | | | | | P | |
| Ex. 4: 2 - 100 KHz; 2 - 200 KHz (all with direction output) | PTO1 | | | | | P | D | | | | | | | | | | |
| | PTO2 | | | | | | | P | D | | | | | | | | |
| | PTO3 | | | | | | | | | | | P | D | | | | |
| | PTO4 | | | | | | | | | | | | | P | D | | |

CPU 1211C, CPU 1212C, CPU 1214C, and CPU 1215C example output speed configurations

The examples below show four possible output speed combinations:

- Example 1: 4 - 100 KHz PTOs, no direction output
- Example 2: 2 - 100 KHz PTOs and 2 - 20 KHz PTOs, all with direction output
- Example 3: 4 - 200 KHz PTOs, no direction output
- Example 4: 2 - 100 KHz PTOs and 2 - 200 KHz PTOs, all with direction output

| P = Pulse D = Direction | CPU on-board outputs | | | | | | | | | | | High-speed SB outputs | | | | Low-speed SB outputs | |
|--|----------------------|-----|-----|-----|-------------------|-----|-----|-----------|-----|-----|-----|-----------------------|-----|-----|-----|----------------------|--|
| | 100KHz Outputs (Q) | | | | 20KHz Outputs (Q) | | | | | | | 200KHz Outputs (Q) | | | | 20Kz Outputs (Q) | |
| | 0.0 | 0.1 | 0.2 | 0.3 | 0.4 | 0.5 | 0.6 | 0.7 | 1.0 | 1.1 | 4.0 | 4.1 | 4.2 | 4.3 | 4.0 | 4.1 | |
| | CPU 1211C | | | | | | | | | | | | | | | | |
| | CPU 1212C | | | | CPU 1212C | | | | | | | | | | | | |
| | CPU 1214C | | | | CPU 1214C | | | CPU 1214C | | | | | | | | | |
| | CPU 1215C | | | | CPU 1215C | | | CPU 1215C | | | | | | | | | |
| Ex. 1: 4 - 100 KHz (no direction output) | PTO1 | P | | | | | | | | | | | | | | | |
| | PTO2 | | P | | | | | | | | | | | | | | |
| | PTO3 | | | P | | | | | | | | | | | | | |
| | PTO4 | | | | P | | | | | | | | | | | | |
| Ex. 2: 2 - 100 KHz; | PTO1 | P | D | | | | | | | | | | | | | | |
| | PTO2 | | | P | D | | | | | | | | | | | | |
| | PTO3 | | | | | P | D | | | | | | | | | | |

| P = Pulse D = Direction | CPU on-board outputs | | | | | | | | | | High-speed SB outputs | | | | Low-speed SB outputs | | |
|---|----------------------|---|---|---|---|--|--|---|---|--|-----------------------|---|---|---|----------------------|--|--|
| | | | | | | | | P | D | | | | | | | | |
| 2 - 20 KHz (all with direction output) | PTO4 | | | | | | | | | | | | | | | | |
| Ex. 3: 4 - 200 KHz (no direction output) | PTO1 | | | | | | | | | | | P | | | | | |
| | PTO2 | | | | | | | | | | | | P | | | | |
| | PTO3 | | | | | | | | | | | | | P | | | |
| | PTO4 | | | | | | | | | | | | | | P | | |
| Ex. 4: 2 - 100 KHz; 2 - 200 KHz (all with direction output) | PTO1 | P | D | | | | | | | | | | | | | | |
| | PTO2 | | | P | D | | | | | | | | | | | | |
| | PTO3 | | | | | | | | | | P | D | | | | | |
| | PTO4 | | | | | | | | | | | | P | D | | | |

9.3.1 Phasing

You have four options for the "Phasing" interface to the stepper/servo drive. These options are as follows:

- PTO (pulse A and direction B): If you select a PTO (pulse A and direction B) option, then one output (P0) controls the pulsing and one output (P1) controls the direction. P1 is high (active) if pulsing is in the positive direction. P1 is low (inactive) if pulsing is in the negative direction:

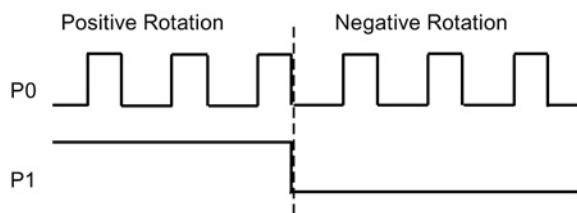

- PTO (count up A and count down B): If you select a PTO (count up A and count down B) option, then one output (P0) pulses for positive directions and a different output (P1) pulses for negative directions:

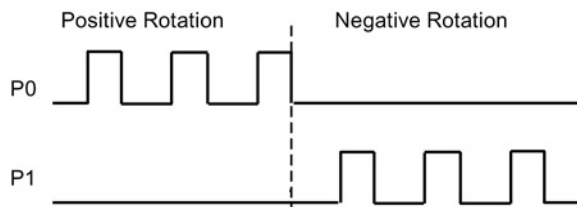

- PTO (A/B phase-shifted): If you select a PTO (A/B phase-shifted) option, then both outputs pulse at the speed specified, but 90 degrees out-of-phase. It is a 1X configuration, meaning one pulse is the amount of time between positive transitions of P0. In this case, the direction is determined by which output transitions high first. P0 leads P1 for the positive direction. P1 leads P0 for the negative direction.

The number of pulses generated is based upon the number of 0 to 1 transitions of Phase A. The phase relationship determines the direction of movement:

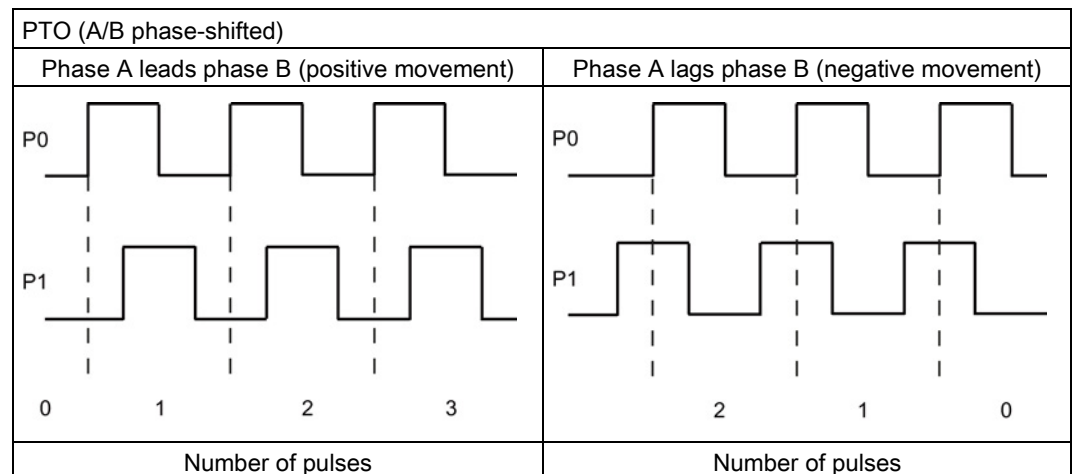

- PTO (A/B phase-shifted - fourfold): If you select a PTO (A/B phase-shifted - fourfold) option, then both outputs pulse at the speed specified, but 90 degrees out-of-phase. The fourfold is a 4X configuration, meaning one pulse is the transition of each output (both positive and negative). In this case, the direction is determined by which output transitions high first. P0 leads P1 for the positive direction. P1 leads P0 for the negative direction.

Fourfold is based upon positive and negative transitions of both Phase A and Phase B. You configure the number of transitions. The phase relationship (A leading B or B leading A) determines the direction of movement.

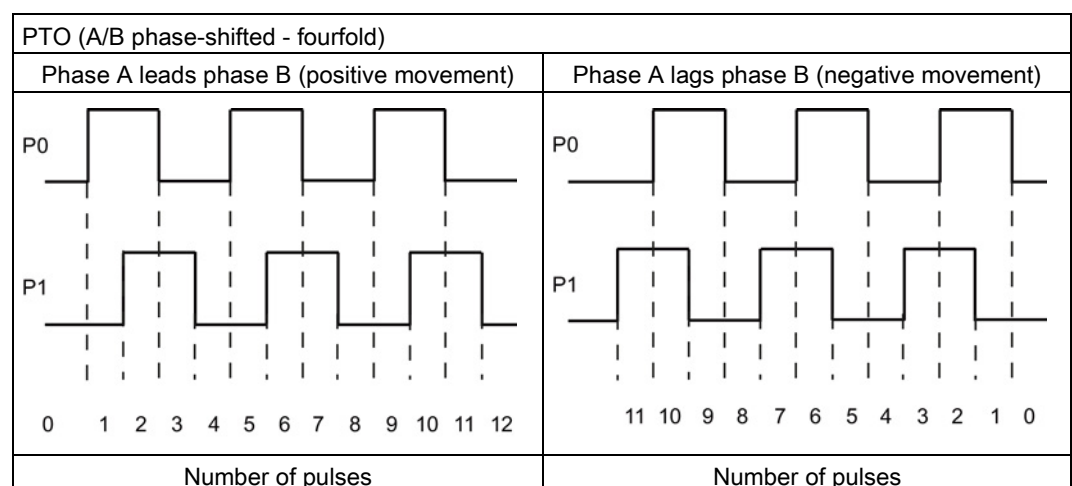

- PTO (pulse and direction (direction de-selected)): If you de-select the direction output in a PTO (pulse and direction (direction de-selected)), then output (P0) controls the pulsing. Output P1 is not used and is available for other program uses. Only positive motion commands are accepted by the CPU in this mode. Motion control restricts you from making illegal negative configurations when you select this mode. You can save an output if your motion application is in one direction only. Single phase (one output) is shown in the figure below (assuming positive polarity):



9.3.2 Configuring a pulse generator

1. Add a Technology object:
 - In the Project tree, expand the node "Technology Objects" and select "Add new object".
 - Select the "Axis" icon (rename if required) and click "OK" to open the configuration editor for the axis object.
 - Display the "Select PTO for Axis Control" properties under the "Basic parameters" and select the desired pulse.

Note

If the PTO has not been previously configured in the CPU Properties, the PTO is configured to use one of the onboard outputs.

If you use an output signal board, then select the "Device configuration" button to go to the CPU Properties. Under "Parameter assignment", in the "Pulse options", configure the output source to a signal board output.

- Configure the remaining Basic and Extended parameters.
2. Program your application: Insert the MC_Power instruction in a code block.
 - For the Axis input, select the axis technology object that you created and configured.
 - Setting the Enable input to TRUE allows the other motion instructions to function.
 - Setting the Enable input FALSE cancels the other motion instructions.

Note

Include only one MC_Power instruction per axis.

3. Insert the other motion instructions to produce the required motion.

Note

Configuring a pulse generator to signal board outputs: Select the "Pulse generators (PTO/PWM)" properties for a CPU (in Device configuration) and enable a pulse generator. Two pulse generators are available for each S7-1200 CPU V1.0, V2.0, V2.1, and V2.2. S7-1200 CPU V3.0 and V4.0 CPUs have four pulse generators available. In this same configuration area under "Pulse options", select Pulse generator used as: "PTO".

Note

The CPU calculates motion tasks in "slices" or segments of 10 ms. As one slice is being executed, the next slice is waiting in the queue to be executed. If you interrupt the motion task on an axis (by executing another new motion task for that axis), the new motion task may not be executed for a maximum of 20 ms (the remainder of the current slice plus the queued slice).

9.3.3 Configuring the axis

STEP 7 provides the configuration tools, the commissioning tools, and the diagnostic tools for the "Axis" technology object.

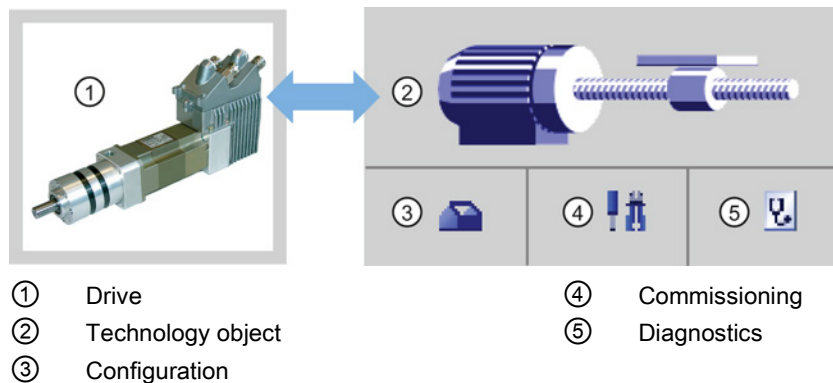
**Note**

For CPU firmware releases V2.2 and earlier, the PTO requires the internal functionality of a high-speed counter (HSC). This means the corresponding HSC cannot be used elsewhere.

The assignment between PTO and HSC is fixed. If PTO1 is activated, it will be connected to HSC1. If PTO2 is activated, it will be connected to HSC2. You cannot monitor the current value (for example, in ID1000) when pulses are occurring.

S7-1200 V3.0 and later CPUs do not have this restriction; all HSCs remain available for program use when pulse outputs are configured in these CPUs.

Table 9- 26 STEP 7 tools for motion control

| Tool | Description |
|---------------|---|
| Configuration | <p>Configures the following properties of the "Axis" technology object:</p> <ul style="list-style-type: none"> • Selection of the PTO to be used and configuration of the drive interface • Properties of the mechanics and the transmission ratio of the drive (or machine or system) • Properties for position limits, dynamics, and homing <p>Save the configuration in the data block of the technology object.</p> |
| Commissioning | <p>Tests the function of your axis without having to create a user program. When the tool is started, the control panel will be displayed. The following commands are available on the control panel:</p> <ul style="list-style-type: none"> • Enable and disable axis • Move axis in jog mode • Position axis in absolute and relative terms • Home axis • Acknowledge errors <p>The velocity and the acceleration / deceleration can be specified for the motion commands. The control panel also shows the current axis status.</p> |
| Diagnostics | Monitors of the current status and error information for the axis and drive. |

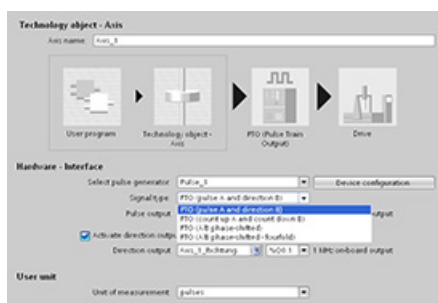

After you create the technology object for the axis, you configure the axis by defining the basic parameters, such as the PTO and the configuration of the drive interface. You also configure the other properties of the axis, such as position limits, dynamics, and homing.

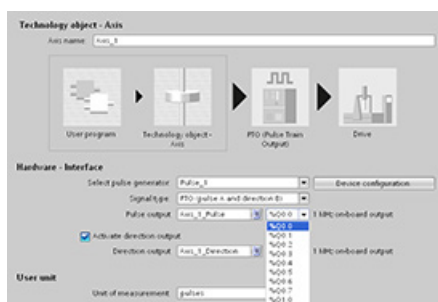

Note

You may have to adapt the values of the input parameters of motion control instructions to the new dimension unit in the user program.



Configure the properties for the drive signals, drive mechanics, and position monitoring (hardware and software limit switches).

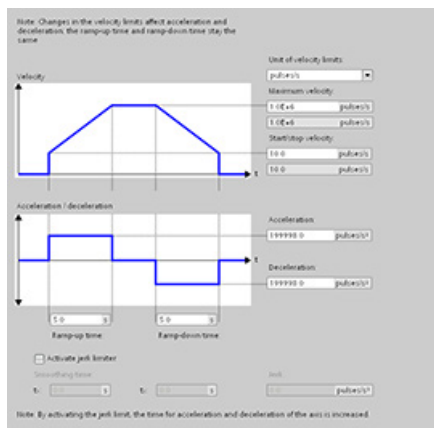

You configure the motion dynamics and the behavior of the emergency stop command.



You also configure the homing behavior (passive and active).

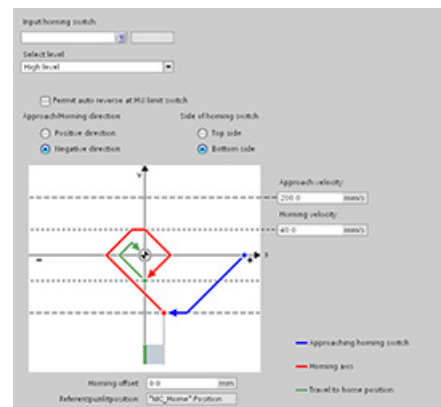

Use the "Commissioning" control panel to test the functionality independently from your user program.

 Click the "Startup" icon to commission the axis.

The control panel shows the current status of the axis. Not only can you enable and disable the axis, but you can also test the positioning of the axis (both in absolute and relative terms) and can specify the velocity, acceleration and deceleration. You can also test the homing and jogging tasks. The control panel also allows you to acknowledge errors.

9.3.4 Configuring the TO_CommandTable_PTO

You can configure a CommandTable instruction using the Technology objects.

Adding a Technology object

1. In the Project tree, expand the node "Technology Objects" and select "Add new object".
2. Select the "CommandTable" icon (rename if required), and click "OK" to open the configuration editor for the CommandTable object.

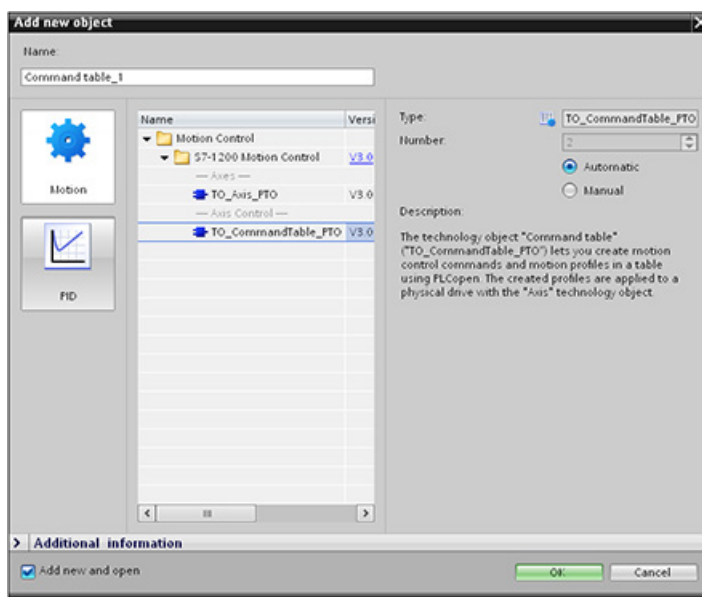

Planning the steps for your application

You can create the desired movement sequence in the "Command Table" configuration window, and check the result against the graphic view in the trend diagram.

You can select the command types that are to be used for processing the command table. Up to 32 steps can be entered. The commands are processed in sequence, easily producing a complex motion profile.

Table 9- 27 MC_CommandTable command types

| Command type | Description |
|----------------------|--|
| Empty | The empty serves as a placeholder for any commands to be added. The empty entry is ignored when the command table is processed |
| Halt | Pause axis. Note: The command only takes place after a "Velocity setpoint" command. |
| Positioning Relative | Positions the axis based upon distance. The command moves the axis by the given distance and velocity. |
| Positioning Absolute | Positions the axis based upon location. The command moves the axis to the given location, using the velocity specified. |
| Velocity setpoint | Moves the axis at the given velocity. |

| Command type | Description |
|--------------|---|
| Wait | Waits until the given period is over. "Wait" does not stop an active traversing motion. |
| Separator | Adds a "Separator" line above the selected line. The separator line allows more than one profile to be defined in a single command table. |

In the figure below, "Command complete" is used as the transition to the next step. This type of transition allows your device to decelerate to the start/stop speed and then accelerate once again at the start of the next step.

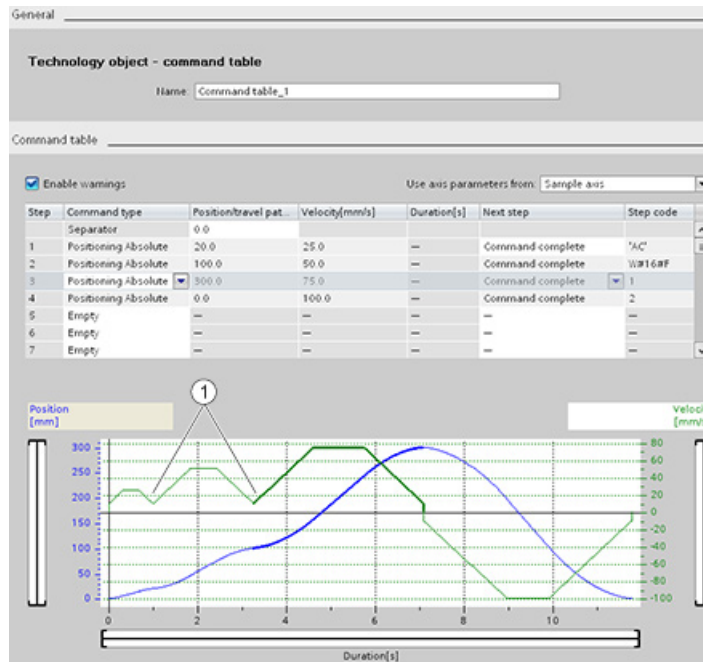

① Axis decelerates to the start/stop speed between steps.

In the figure below, "Blending motion" is used as the transition to the next step. This type of transition allows your device to maintain its velocity into the start of the next step, resulting in a smooth transition for the device from one step to the next. Using blending can shorten the total time required for a profile to execute completely. Without blending, the example takes seven seconds to run. With blending, the execution time is reduced by one second to a total of six seconds.

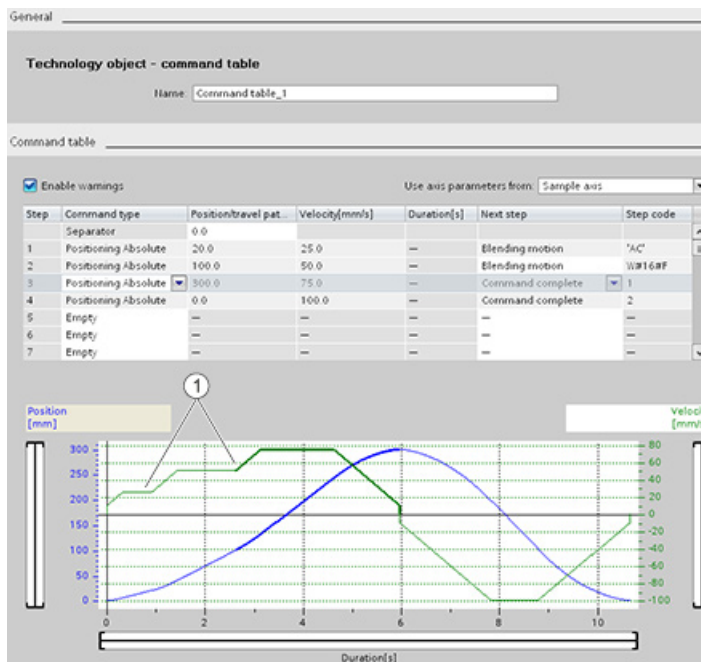

① Axis continues to move and accelerates or decelerates to the next step velocity, saving time and mechanical wear.

The operation of your CommandTable is controlled by an MC_CommandTable instruction, as shown below:

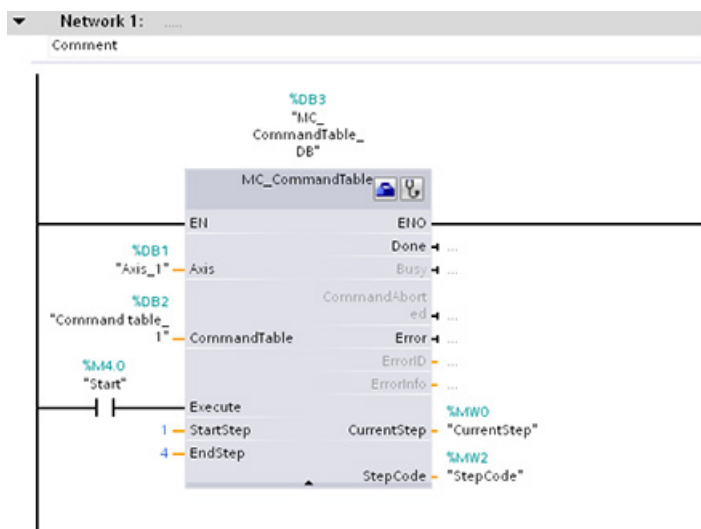

9.3.5 Motion control instructions

9.3.5.1 MC instruction overview

The motion control instructions use an associated technology data block and the dedicated PTO (pulse train outputs) of the CPU to control the motion on an axis.

- MC_Power (Page 456) enables and disables a motion control axis.
- MC_Reset (Page 459) resets all motion control errors. All motion control errors that can be acknowledged are acknowledged.
- MC_Home (Page 460) establishes the relationship between the axis control program and the axis mechanical positioning system.
- MC_Halt (Page 462) cancels all motion processes and causes the axis motion to stop. The stop position is not defined.
- MC_MoveAbsolute (Page 464) starts motion to an absolute position. The job ends when the target position is reached.
- MC_MoveRelative (Page 466) starts a positioning motion relative to the start position.
- MC_MoveVelocity (Page 468) causes the axis to travel with the specified speed.
- MC_MoveJog (Page 471) executes jog mode for testing and startup purposes.
- MC_CommandTable (Page 473) runs axis commands as a movement sequence.
- MC_ChangeDynamic (Page 476) changes Dynamics settings for the axis.
- MC_WriteParam (Page 478) writes a select number of parameters to change the functionality of the axis from the user program.
- MC_ReadParam (Page 480) reads a select number of parameters that indicate the current position, velocity, and so forth of the axis defined in the Axis input.

CPU firmware levels

If you have an S7-1200 CPU with V4.0 firmware, select the V4.0 version of each motion instruction.

If you have an S7-1200 CPU with V3.0 or earlier firmware, select the applicable V3.0, V2.0, or V1.0 version of each motion instruction.

Note

The CPU calculates motion tasks in "slices" or segments of 10 ms. As one slice is being executed, the next slice is waiting in the queue to be executed. If you interrupt the motion task on an axis (by executing another new motion task for that axis), the new motion task may not be executed for a maximum of 20 ms (the remainder of the current slice plus the queued slice).

9.3.5.2 MC_Power (Release/block axis) instruction

Note

If the axis is switched off due to an error, it will be enabled again automatically after the error has been eliminated and acknowledged. This requires that the Enable input parameter has retained the value TRUE during this process.

Table 9- 28 MC_Power instruction

| LAD / FBD | SCL | Description |
|-----------|--|---|
| | <pre>"MC_Power_DB" (Axis:= _multi_fb_in_, Enable:= _bool_in_, StopMode:= _int_in_, Status=> _bool_out_, Busy=> _bool_out_, Error=> _bool_out_, ErrorID=> _word_out_, ErrorInfo=> _word_out_);</pre> | <p>The MC_Power motion control instruction enables or disables an axis. Before you can enable or disable the axis, ensure the following conditions:</p> <ul style="list-style-type: none"> • The technology object has been configured correctly. • There is no pending enable-inhibiting error. <p>The execution of MC_Power cannot be aborted by a motion control task. Disabling the axis (input parameter Enable = FALSE) aborts all motion control tasks for the associated technology object.</p> |

- STEP 7 automatically creates the DB when you insert the instruction.
- In the SCL example, "MC_Power_DB" is the name of the instance DB.

Table 9- 29 Parameters for the MC_Power instruction

| Parameter and type | Data type | Description |
|--------------------|-----------|--|
| Axis | IN | TO_Axis_1 Axis technology object |
| Enable | IN | Bool <ul style="list-style-type: none"> • FALSE (default): All active tasks are aborted according to the parameterized "StopMode" and the axis is stopped. • TRUE: Motion Control attempts to enable the axis. |
| StopMode | IN | Int <ul style="list-style-type: none"> • 0: Emergency stop: If a request to disable the axis is pending, the axis brakes at the configured emergency deceleration. The axis is disabled after reaching standstill. • 1: Immediate stop: If a request to disable the axis is pending, this axis is disabled without deceleration. Pulse output is stopped immediately. • 2: Emergency stop with jerk control: If a request to disable the axis is pending, the axis brakes at the configured emergency stop deceleration. If the jerk control is activated, the configured jerk is taken into account. The axis is disabled after reaching standstill. |

| Parameter and type | Data type | Description | |
|--------------------|-----------|-------------|---|
| Status | OUT | Bool | Status of axis enable: <ul style="list-style-type: none"> FALSE: The axis is disabled: <ul style="list-style-type: none"> The axis does not execute motion control tasks and does not accept any new tasks (exception: MC_Reset task). The axis is not homed. Upon disabling, the status does not change to FALSE until the axis reaches a standstill. TRUE: The axis is enabled: <ul style="list-style-type: none"> The axis is ready to execute motion control tasks. Upon axis enabling, the status does not change to TRUE until the signal "Drive ready" is pending. If the "Drive ready" drive interface was not configured in the axis configuration, the status changes to TRUE immediately. |
| Busy | OUT | Bool | FALSE: MC_Power is not active. TRUE: MC_Power is active. |
| Error | OUT | Bool | FALSE: No error TRUE: An error has occurred in motion control instruction "MC_Power" or in the associated technology object. The cause of the error can be found in parameters "ErrorID" and "ErrorInfo". |
| ErrorID | OUT | Word | Error ID for parameter "ErrorID" |
| ErrorInfo | OUT | Word | Error info ID for parameter "ErrorID" |

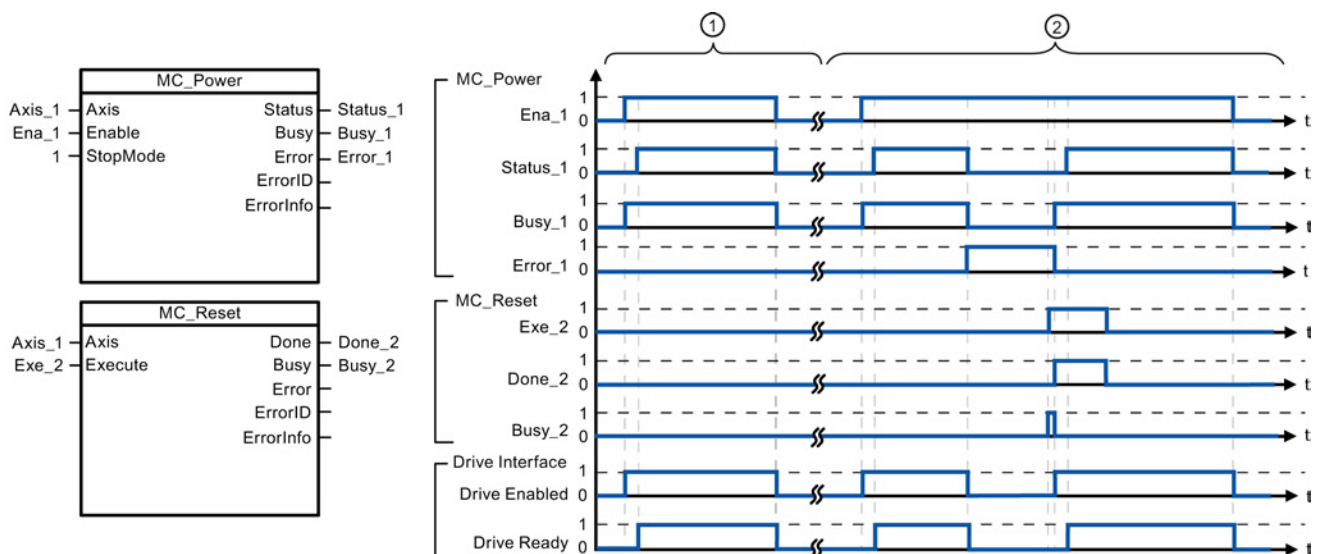

- ① An axis is enabled and then disabled again. After the drive has signaled "Drive ready" back to the CPU, the successful enable can be read out via "Status_1".
- ② Following an axis enable, an error has occurred that caused the axis to be disabled. The error is eliminated and acknowledged with "MC_Reset". The axis is then enabled again.

To enable an axis with configured drive interface, follow these steps:

1. Check the requirements indicated above.
2. Initialize input parameter "StopMode" with the desired value. Set input parameter "Enable" to TRUE.

The enable output for "Drive enabled" changes to TRUE to enable the power to the drive. The CPU waits for the "Drive ready" signal of the drive.

When the "Drive ready" signal is available at the configured ready input of the CPU, the axis becomes enabled. Output parameter "Status" and technology object tag <Axis name>.StatusBits.Enable indicates the value TRUE.

To enable an axis without configured drive interface, follow these steps:

1. Check the requirements indicated above.
2. Initialize input parameter "StopMode" with the desired value. Set input parameter "Enable" to TRUE. The axis is enabled. Output parameter "Status" and technology object tag <Axis name>.StatusBits.Enable indicate the value TRUE.

To disable an axis, follow these steps:

1. Bring the axis to a standstill.
You can identify when the axis is at a standstill in technology object tag <Axis name>.StatusBits.StandStill.
2. Set input parameter "Enable" to FALSE after standstill is reached.
3. If output parameters "Busy" and "Status" and technology object tag <Axis name>.StatusBits.Enable indicate the value FALSE, disabling of the axis is complete.

9.3.5.3 MC_Reset (Confirm error) instruction

Table 9- 30 MC_Reset instruction

| LAD / FBD | SCL | Description |
|---|--|---|
|  | <pre>"MC_Reset_DB" (Axis:=_multi_fb_in_, Execute:=_bool_in_, Restart:=_bool_in_, Done=>_bool_out_, Busy=>_bool_out_, Error=>_bool_out_, ErrorID=>_word_out_, ErrorInfo=>_word_out_);</pre> | <p>Use the MC_Reset instruction to acknowledge "Operating error with axis stop" and "Configuration error". The errors that require acknowledgement can be found in the "List of ErrorIDs and ErrorInfos" under "Remedy".</p> <p>Before using the MC_Reset instruction, you must have eliminated the cause of a pending configuration error requiring acknowledgement (for example, by changing an invalid acceleration value in "Axis" technology object to a valid value).</p> <p>As of V3.0 and later, the Restart command allows the axis configuration to be downloaded to the work memory in the RUN operating mode.</p> |

- STEP 7 automatically creates the DB when you insert the instruction.
- In the SCL example, "MC_Reset_DB" is the name of the instance DB.

The MC_Reset task cannot be aborted by any other motion control task. The new MC_Reset task does not abort any other active motion control tasks.

Table 9- 31 Parameters of the MC_Reset instruction

| Parameter and type | Data type | Description |
|--------------------|-----------|--|
| Axis | IN | TO_Axis_1 Axis technology object |
| Execute | IN | Bool Start of the task with a positive edge |
| Restart | IN | Bool TRUE = Download the axis configuration from the load memory to the work memory. The command can only be executed when the axis is disabled. FALSE = Acknowledges pending errors |
| Done | OUT | Bool TRUE = Error has been acknowledged. |
| Busy | OUT | Bool TRUE = The task is being executed. |
| Error | OUT | Bool TRUE = An error has occurred during execution of the task. The cause of the error can be found in parameters "ErrorID" and "ErrorInfo". |
| ErrorID | OUTP | Word Error ID for parameter "Error" |
| ErrorInfo | OUT | Word Error info ID for parameter "ErrorID" |

To acknowledge an error with MC_Reset, follow these steps:

- Check the requirements indicated above.
- Start the acknowledgement of the error with a rising edge at the Execute input parameter.
- The error has been acknowledged when Done equals TRUE and the technology object tag <Axis name>.StatusBits.Error equals FALSE.

9.3.5.4 MC_Home (Home axis) instruction

Table 9- 32 MC_Home instruction

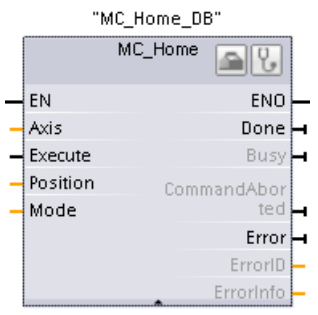
| LAD / FBD | SCL | Description |
|---|---|---|
|  | <pre>"MC_Home_DB" (Axis:=_multi_fb_in_, Execute:=_bool_in_, Position:=_real_in_, Mode:=_int_in_, Done=>_bool_out_, Busy=>_bool_out_, CommandAborted=>_bool_out_, Error=>_bool_out_, ErrorID=>_word_out_, ErrorInfo=>_word_out_);</pre> | <p>Use the MC_Home instruction to match the axis coordinates to the real, physical drive position. Homing is required for absolute positioning of the axis:</p> <p>In order to use the MC_Home instruction, the axis must first be enabled.</p> |

- 1 STEP 7 automatically creates the DB when you insert the instruction.
- 2 In the SCL example, "MC_Home_DB" is the name of the instance DB.

The following types of homing are available:

- Direct homing absolute (Mode = 0): The current axis position is set to the value of parameter "Position".
- Direct homing relative (Mode = 1): The current axis position is offset by the value of parameter "Position".
- Passive homing (Mode = 2): During passive homing, the MC_Home instruction does not carry out any homing motion. The traversing motion required for this step must be implemented by the user via other motion control instructions. When the reference point switch is detected, the axis is homed.
- Active homing (Mode = 3): The homing procedure is executed automatically.

Table 9- 33 Parameters for the MC_Home instruction

| Parameter and type | | Data type | Description |
|--------------------|-----|-------------|---|
| Axis | IN | TO_Axis_PTO | Axis technology object |
| Execute | IN | Bool | Start of the task with a positive edge |
| Position | IN | Real | <ul style="list-style-type: none"> Mode = 0, 2, and 3 (Absolute position of axis after completion of the homing operation) Mode = 1 (Correction value for the current axis position) Limit values: $-1.0e^{12} \leq \text{Position} \leq 1.0e^{12}$ |
| Mode | IN | Int | Homing mode <ul style="list-style-type: none"> 0: Direct homing absolute New axis position is the position value of parameter "Position". 1: Direct homing relative New axis position is the current axis position + position value of parameter "Position". 2: Passive homing Homing according to the axis configuration. Following homing, the value of parameter "Position" is set as the new axis position. 3: Active homing Reference point approach in accordance with the axis configuration. Following homing, the value of parameter "Position" is set as the new axis position. |
| Done | OUT | Bool | TRUE = Task completed |
| Busy | OUT | Bool | TRUE = The task is being executed. |
| CommandAborted | OUT | Bool | TRUE = During execution the task was aborted by another task. |
| Error | OUT | Bool | TRUE = An error has occurred during execution of the task. The cause of the error can be found in parameters "ErrorID" and "ErrorInfo". |
| ErrorID | OUT | Word | Error ID for parameter "Error" |
| ErrorInfo | OUT | Word | Error info ID for parameter "ErrorID" |

Note**Axis homing is lost under the following conditions**

- Disabling of axis by the MC_Power instruction
- Switchover between automatic control and manual control
- Upon start of active homing (After successful completion of the homing operation, axis homing is available again.)
- After power-cycling the CPU
- After CPU restart (RUN-to-STOP or STOP-to-RUN)

9.3 Motion control

To home the axis, follow these steps:

1. Check the requirements indicated above.
2. Initialize the necessary input parameters with values, and start the homing operation with a rising edge at input parameter "Execute".
3. If output parameter "Done" and technology object tag <Axis name>.StatusBits.HomingDone indicate the value TRUE, homing is complete.

Table 9- 34 Override response

| Mode | Description | | |
|---|--|---|--|
| 0 or 1 | The MC_Home task cannot be aborted by any other motion control task. The new MC_Home task does not abort any active motion control tasks. Position-related motion tasks are resumed after homing according to the new homing position (value at the Position input parameter). | | |
| 2 | The MC_Home task can be aborted by the following motion control tasks: MC_Home task Mode = 2, 3: The new MC_Home task aborts the following active motion control task. MC_Home task Mode = 2: Position-related motion tasks are resumed after homing according to the new homing position (value at the Position input parameter). | | |
| 3 | <table border="0" style="width: 100%;"> <tr> <td style="width: 50%; vertical-align: top;"> The MC_Home task can be aborted by the following motion control tasks: <ul style="list-style-type: none"> • MC_Home Mode = 3 • MC_Halt • MC_MoveAbsolute • MC_MoveRelative • MC_MoveVelocity • MC_MoveJog </td> <td style="width: 50%; vertical-align: top;"> The new MC_Home task aborts the following active motion control tasks: <ul style="list-style-type: none"> • MC_Home Mode = 2, 3 • MC_Halt • MC_MoveAbsolute • MC_MoveRelative • MC_MoveVelocity • MC_MoveJog </td> </tr> </table> | The MC_Home task can be aborted by the following motion control tasks: <ul style="list-style-type: none"> • MC_Home Mode = 3 • MC_Halt • MC_MoveAbsolute • MC_MoveRelative • MC_MoveVelocity • MC_MoveJog | The new MC_Home task aborts the following active motion control tasks: <ul style="list-style-type: none"> • MC_Home Mode = 2, 3 • MC_Halt • MC_MoveAbsolute • MC_MoveRelative • MC_MoveVelocity • MC_MoveJog |
| The MC_Home task can be aborted by the following motion control tasks: <ul style="list-style-type: none"> • MC_Home Mode = 3 • MC_Halt • MC_MoveAbsolute • MC_MoveRelative • MC_MoveVelocity • MC_MoveJog | The new MC_Home task aborts the following active motion control tasks: <ul style="list-style-type: none"> • MC_Home Mode = 2, 3 • MC_Halt • MC_MoveAbsolute • MC_MoveRelative • MC_MoveVelocity • MC_MoveJog | | |

9.3.5.5 MC_Halt (Pause axis) instruction

Table 9- 35 MC_Halt instruction

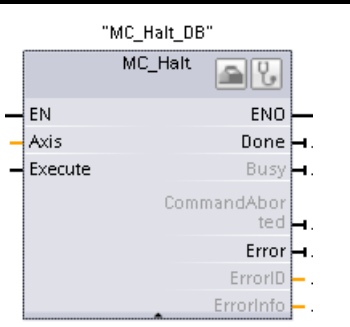
| LAD / FBD | SCL | Description |
|---|--|--|
|  | <pre> "MC_Halt_DB" (Axis:= multi_fb_in_, Execute:= bool_in_, Done=> bool_out_, Busy=> bool_out_, CommandAborted=> bool_out_, Error=> bool_out_, ErrorID=> word_out_, ErrorInfo=> word_out_); </pre> | <p>Use the MC_Halt instruction to stop all motion and to bring the axis to a stand-still. The stand-still position is not defined.</p> <p>In order to use the MC_Halt instruction, the axis must first be enabled.</p> |

- 1 STEP 7 automatically creates the DB when you insert the instruction.
- 2 In the SCL example, "MC_Halt_DB" is the name of the instance DB.

Table 9- 36 Parameters for the MC_Halt instruction

| Parameter and type | | Data type | Description |
|--------------------|-----|-----------|---|
| Axis | IN | TO_Axis_1 | Axis technology object |
| Execute | IN | Bool | Start of the task with a positive edge |
| Done | OUT | Bool | TRUE = Zero velocity reached |
| Busy | OUT | Bool | TRUE = The task is being executed. |
| CommandAborted | OUT | Bool | TRUE = During execution the task was aborted by another task. |
| Error | OUT | Bool | TRUE = An error has occurred during execution of the task. The cause of the error can be found in parameters "ErrorID" and "ErrorInfo". |
| ErrorID | OUT | Word | Error ID for parameter "Error" |
| ErrorInfo | OUT | Word | Error info ID for parameter "ErrorID" |

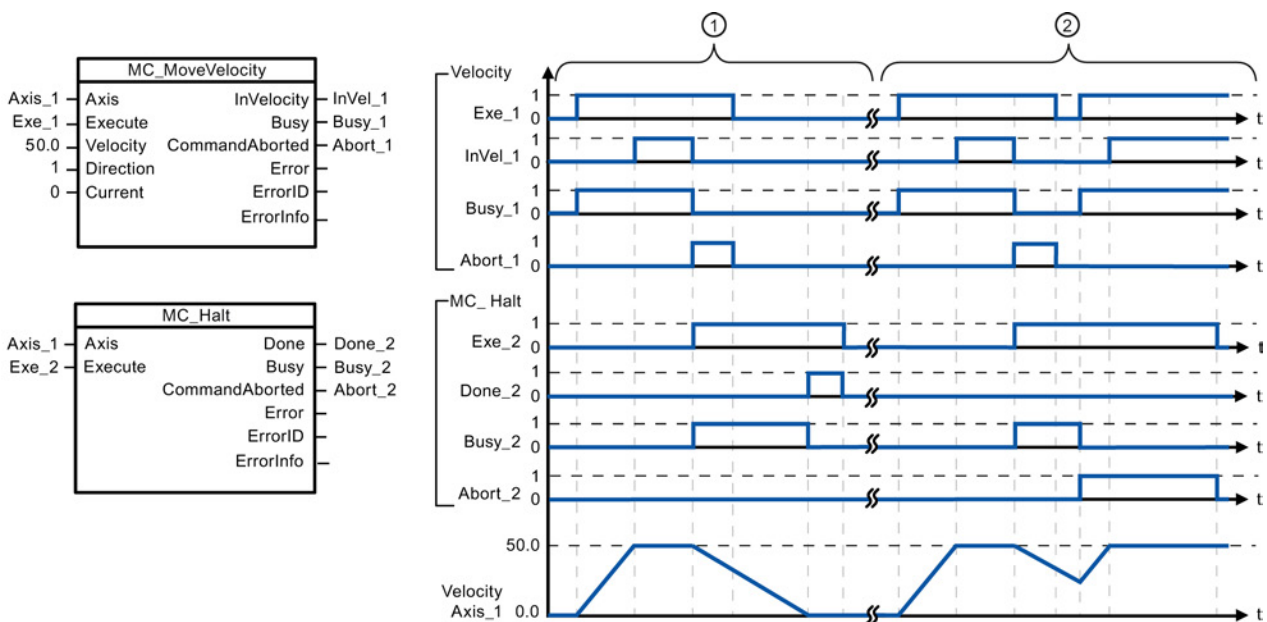

The following values were configured in the "Dynamics > General" configuration window: Acceleration = 10.0 and Deceleration = 5.0

- ① The axis is braked by an MC_Halt task until it comes to a standstill. The axis standstill is signaled via "Done_2".
- ② While an MC_Halt task is braking the axis, this task is aborted by another motion task. The abort is signaled via "Abort_2".

Override response

The MC_Halt task can be aborted by the following motion control tasks:

- MC_Home Mode = 3
- MC_Halt
- MC_MoveAbsolute
- MC_MoveRelative
- MC_MoveVelocity
- MC_MoveJog

The new MC_Halt task aborts the following active motion control tasks:

- MC_Home Mode = 3
- MC_Halt
- MC_MoveAbsolute
- MC_MoveRelative
- MC_MoveVelocity
- MC_MoveJog

9.3.5.6 MC_MoveAbsolute (Position axis absolutely) instruction

Table 9- 37 MC_MoveAbsolute instruction

| LAD / FBD | SCL | Description |
|-----------|--|--|
| | <pre>"MC_MoveAbsolute_DB" (Axis:=_multi_fb_in_, Execute:=_bool_in_, Position:=_real_in_, Velocity:=_real_in_, Done=>_bool_out_, Busy=>_bool_out_, CommandAborted=>_bool_out_, Error=>_bool_out_, ErrorID=>_word_out_, ErrorInfo=>_word_out_);</pre> | <p>Use the MC_MoveAbsolute instruction to start a positioning motion of the axis to an absolute position.</p> <p>In order to use the MC_MoveAbsolute instruction, the axis must first be enabled and also must be homed.</p> |

- 1 STEP 7 automatically creates the DB when you insert the instruction.
- 2 In the SCL example, "MC_MoveAbsolute_DB" is the name of the instance DB.

Table 9- 38 Parameters for the MC_MoveAbsolute instruction

| Parameter and type | Data type | Description |
|--------------------|-----------|---|
| Axis | IN | TO_Axis_1 Axis technology object |
| Execute | IN | Bool Start of the task with a positive edge (Default value: False) |
| Position | IN | Real Absolute target position (Default value: 0.0) Limit values: $-1.0e^{12} \leq \text{Position} \leq 1.0e^{12}$ |
| Velocity | IN | Real Velocity of axis (Default value: 10.0) This velocity is not always reached because of the configured acceleration and deceleration and the target position to be approached. Limit values: $\text{Start/stop velocity} \leq \text{Velocity} \leq \text{maximum velocity}$ |
| Done | OUT | Bool TRUE = Absolute target position reached |
| Busy | OUT | Bool TRUE = The task is being executed. |

| Parameter and type | Data type | Description | |
|--------------------|-----------|-------------|---|
| CommandAborted | OUT | Bool | TRUE = During execution the task was aborted by another task. |
| Error | OUT | Bool | TRUE = An error has occurred during execution of the task. The cause of the error can be found in parameters "ErrorID" and "ErrorInfo". |
| ErrorID | OUT | Word | Error ID for parameter "Error" (Default value: 0000) |
| ErrorInfo | OUT | Word | Error info ID for parameter "ErrorID" (Default value: 0000) |

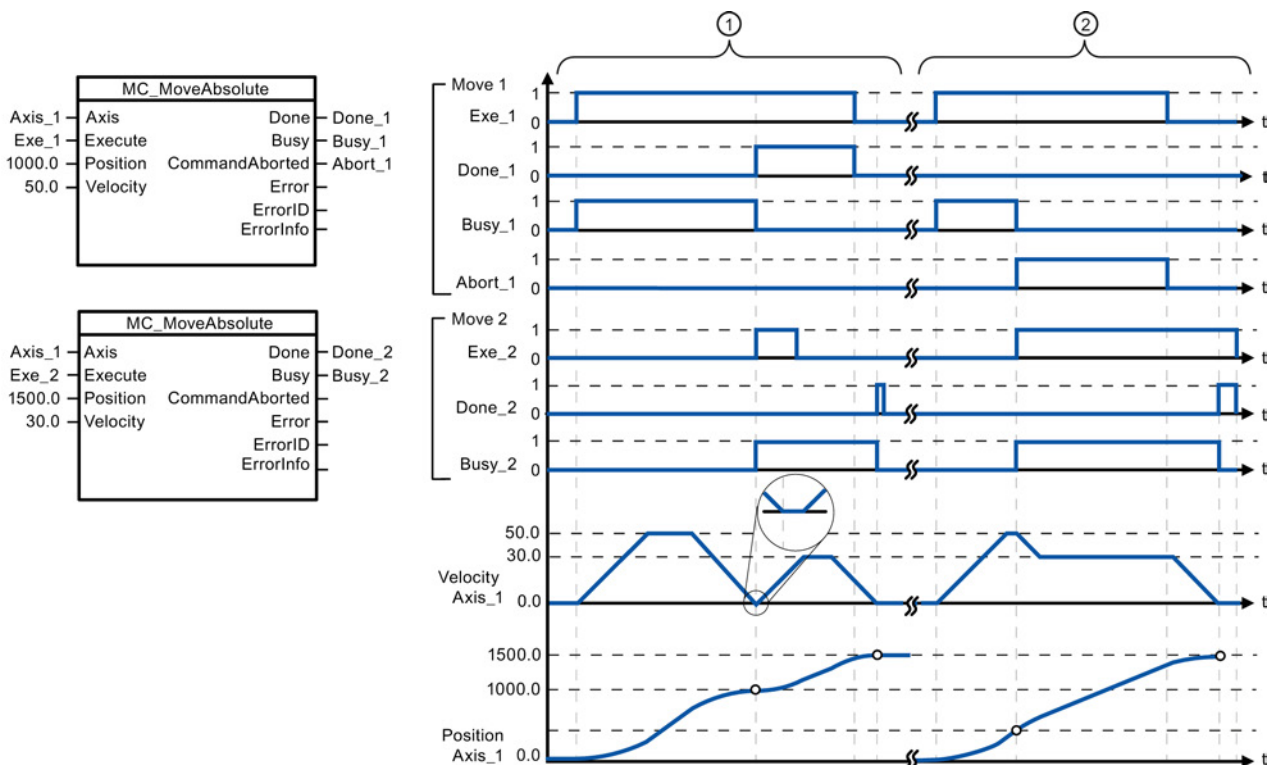

The following values were configured in the "Dynamics > General" configuration window: Acceleration = 10.0 and Deceleration = 10.0

- ① An axis is moved to absolute position 1000.0 with a MC_MoveAbsolute task. When the axis reaches the target position, this is signaled via "Done_1". When "Done_1" = TRUE, another MC_MoveAbsolute task, with target position 1500.0, is started. Because of the response times (e.g., cycle time of user program, etc.), the axis comes to a standstill briefly (see zoomed-in detail). When the axis reaches the new target position, this is signaled via "Done_2".
- ② An active MC_MoveAbsolute task is aborted by another MC_MoveAbsolute task. The abort is signaled via "Abort_1". The axis is then moved at the new velocity to the new target position 1500.0. When the new target position is reached, this is signaled via "Done_2".

Override response

The MC_MoveAbsolute task can be aborted by the following motion control tasks:

- MC_Home Mode = 3
- MC_Halt
- MC_MoveAbsolute
- MC_MoveRelative
- MC_MoveVelocity
- MC_MoveJog

The new MC_MoveAbsolute task aborts the following active motion control tasks:

- MC_Home Mode = 3
- MC_Halt
- MC_MoveAbsolute
- MC_MoveRelative
- MC_MoveVelocity
- MC_MoveJog

9.3.5.7 MC_MoveRelative (Position axis relatively) instruction

Table 9- 39 MC_MoveRelative instruction

| LAD / FBD | SCL | Description |
|-----------|--|--|
| | <pre>"MC_MoveRelative_DB" (Axis:=_multi_fb_in_, Execute:=_bool_in_, Distance:=_real_in_, Velocity:=_real_in_, Done=>_bool_out_, Busy=>_bool_out_, CommandAborted=>_bool_out_, Error=>_bool_out_, ErrorID=>_word_out_, ErrorInfo=>_word_out_);</pre> | <p>Use the MC_MoveRelative instruction to start a positioning motion relative to the start position.</p> <p>In order to use the MC_MoveRelative instruction, the axis must first be enabled.</p> |

- 1 STEP 7 automatically creates the DB when you insert the instruction.
- 2 In the SCL example, "MC_MoveRelative_DB " is the name of the instance DB.

Table 9- 40 Parameters for the MC_MoveRelative instruction

| Parameter and type | Data type | Description |
|--------------------|-----------|---|
| Axis | IN | TO_Axis_1 Axis technology object |
| Execute | IN | Bool Start of the task with a positive edge (Default value: False) |
| Distance | IN | Real Travel distance for the positioning operation (Default value: 0.0) Limit values: $-1.0e^{12} \leq \text{Distance} \leq 1.0e^{12}$ |
| Velocity | IN | Real Velocity of axis (Default value: 10.0) This velocity is not always reached on account of the configured acceleration and deceleration and the distance to be traveled. Limit values: $\text{Start/stop velocity} \leq \text{Velocity} \leq \text{maximum velocity}$ |
| Done | OUT | Bool TRUE = Target position reached |
| Busy | OUT | Bool TRUE = The task is being executed. |

| Parameter and type | Data type | Description |
|--------------------|-----------|-------------|
| CommandAborted | OUT | Bool |
| Error | OUT | Bool |
| ErrorID | OUT | Word |
| ErrorInfo | OUT | Word |

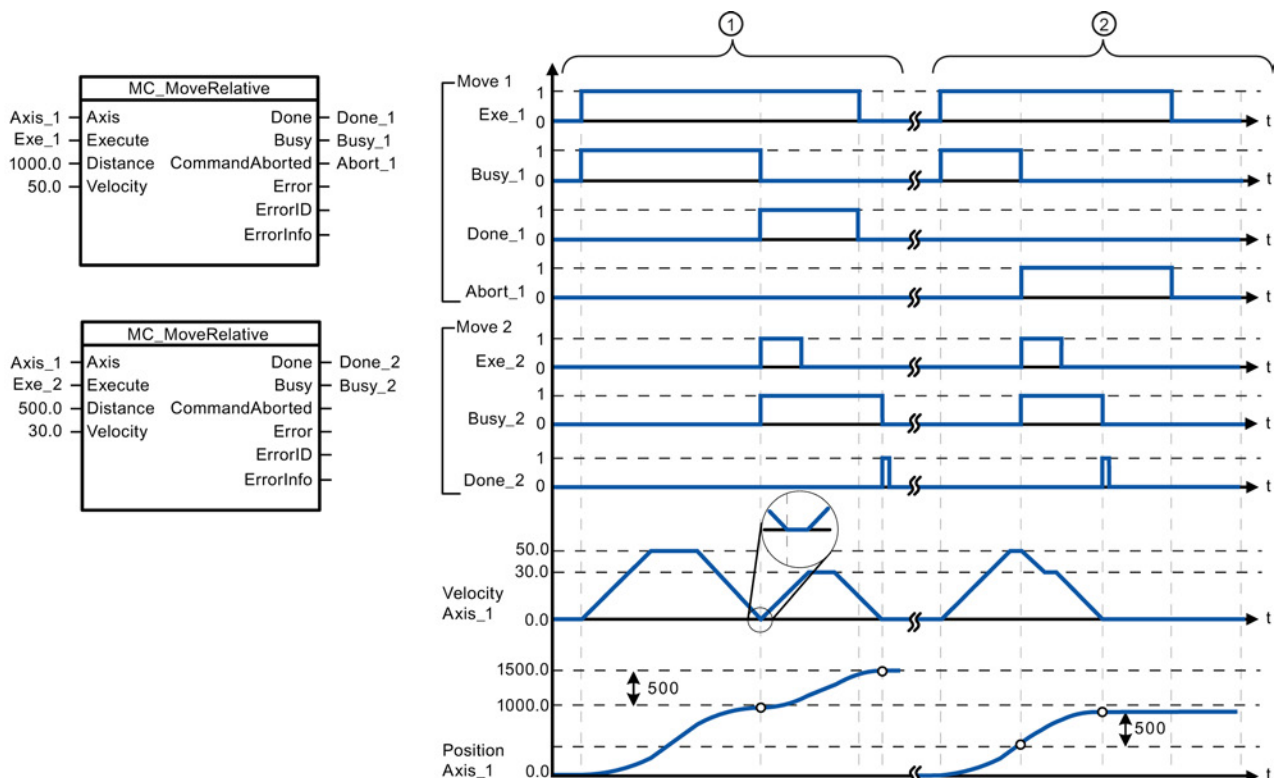

The following values were configured in the "Dynamics > General" configuration window: Acceleration = 10.0 and Deceleration = 10.0

- ① The axis is moved by an MC_MoveRelative task by the distance ("Distance") 1000.0. When the axis reaches the target position, this is signaled via "Done_1". When "Done_1" = TRUE, another MC_MoveRelative task, with travel distance 500.0, is started. Because of the response times (for example, cycle time of user program), the axis comes to a standstill briefly (see zoomed-in detail). When the axis reaches the new target position, this is signaled via "Done_2".
- ② An active MC_MoveRelative task is aborted by another MC_MoveRelative task. The abort is signaled via "Abort_1". The axis is then moved at the new velocity by the new distance ("Distance") 500.0. When the new target position is reached, this is signaled via "Done_2".

Override response

The MC_MoveRelative task can be aborted by the following motion control tasks:

- MC_Home Mode = 3
- MC_Halt
- MC_MoveAbsolute
- MC_MoveRelative
- MC_MoveVelocity
- MC_MoveJog

The new MC_MoveRelative task aborts the following active motion control tasks:

- MC_Home Mode = 3
- MC_Halt
- MC_MoveAbsolute
- MC_MoveRelative
- MC_MoveVelocity
- MC_MoveJog

9.3.5.8 MC_MoveVelocity (Move axis at predefined velocity) instruction

Table 9- 41 MC_MoveVelocity instruction

| LAD / FBD | SCL | Description |
|-----------|--|---|
| | <pre>"MC_MoveVelocity_DB" (Axis:= _multi_fb_in_, Execute:= _bool_in_, Velocity:= _real_in_, Direction:= _int_in_, Current:= _bool_in_, InVelocity=> _bool_out_, Busy=> _bool_out_, CommandAborted=> _bool_out_, Error=> _bool_out_, ErrorID=> _word_out_, ErrorInfo=> _word_out_);</pre> | <p>Use the MC_MoveVelocity instruction to move the axis constantly at the specified velocity.</p> <p>In order to use the MC_MoveVelocity instruction, the axis must first be enabled.</p> |

- 1 STEP 7 automatically creates the DB when you insert the instruction.
- 2 In the SCL example, "MC_MoveVelocity_DB " is the name of the instance DB.

Table 9- 42 Parameters for the MC_MoveVelocity instruction

| Parameter and type | | Data type | Description |
|--------------------|-----|-----------|--|
| Axis | IN | TO_Axis_1 | Axis technology object |
| Execute | IN | Bool | Start of the task with a positive edge (Default value: False) |
| Velocity | IN | Real | Velocity specification for axis motion (Default value: 10.0) Limit values: Start/stop velocity \leq Velocity \leq maximum velocity (Velocity = 0.0 is allowed) |
| Direction | IN | Int | Direction specification: <ul style="list-style-type: none"> • 0: Direction of rotation corresponds to the sign of the value in parameter "Velocity" (Default value) • 1: Positive direction of rotation (The sign of the value in parameter "Velocity" is ignored.) • 2: Negative direction of rotation (The sign of the value in parameter "Velocity" is ignored.) |
| Current | IN | Bool | Maintain current velocity: <ul style="list-style-type: none"> • FALSE: "Maintain current velocity" is deactivated. The values of parameters "Velocity" and "Direction" are used. (Default value) • TRUE: "Maintain current velocity" is activated. The values in parameters "Velocity" and "Direction" are not taken into account. <p>When the axis resumes motion at the current velocity, the "InVelocity" parameter returns the value TRUE.</p> |
| InVelocity | OUT | Bool | TRUE: <ul style="list-style-type: none"> • If "Current" = FALSE: The velocity specified in parameter "Velocity" was reached. • If "Current" = TRUE: The axis travels at the current velocity at the start time. |
| Busy | OUT | Bool | TRUE = The task is being executed. |
| CommandAborted | OUT | Bool | TRUE = During execution the task was aborted by another task. |
| Error | OUT | Bool | TRUE = An error has occurred during execution of the task. The cause of the error can be found in parameters "ErrorID" and "ErrorInfo". |
| ErrorID | OUT | Word | Error ID for parameter "Error" (Default value: 0000) |
| ErrorInfo | OUT | Word | Error info ID for parameter "ErrorID" (Default value: 0000) |

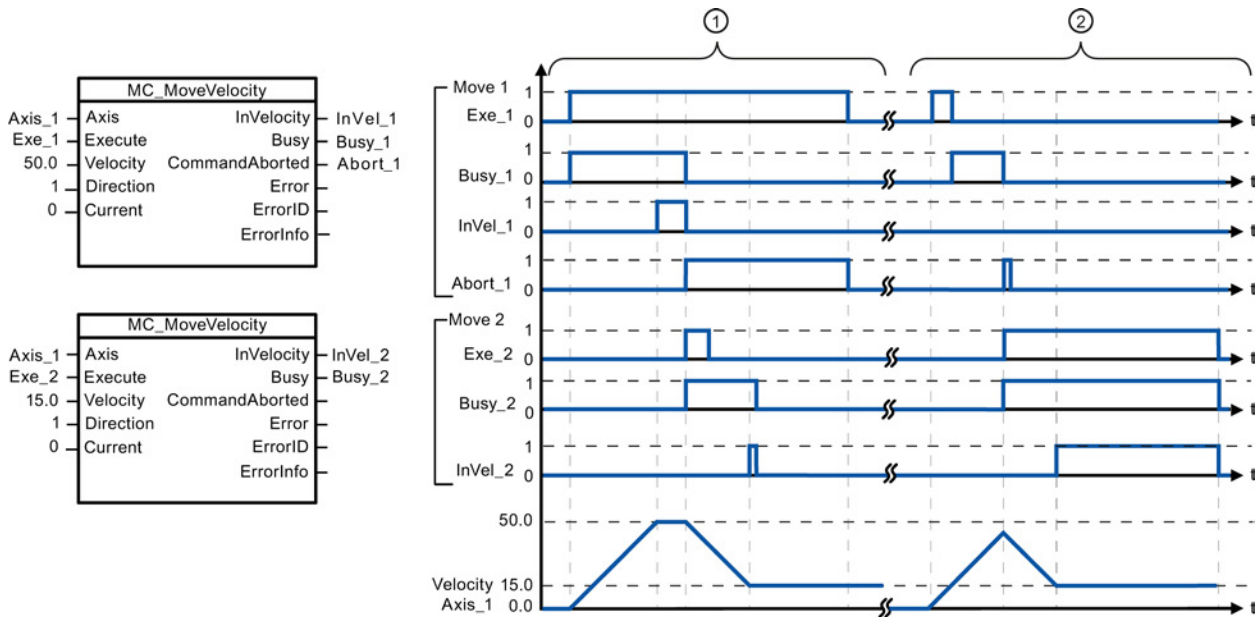

The following values were configured in the "Dynamics > General" configuration window: Acceleration = 10.0 and Deceleration = 10.0

- ① An active MC_MoveVelocity task signals via "InVel_1" that its target velocity has been reached. It is then aborted by another MC_MoveVelocity task. The abort is signaled via "Abort_1". When the new target velocity 15.0 is reached, this is signaled via "InVel_2". The axis then continues moving at the new constant velocity.
- ② An active MC_MoveVelocity task is aborted by another MC_MoveVelocity task prior to reaching its target velocity. The abort is signaled via "Abort_1". When the new target velocity 15.0 is reached, this is signaled via "InVel_2". The axis then continues moving at the new constant velocity.

Override response

The MC_MoveVelocity task can be aborted by the following motion control tasks:

- MC_Home Mode = 3
- MC_Halt
- MC_MoveAbsolute
- MC_MoveRelative
- MC_MoveVelocity
- MC_MoveJog

The new MC_MoveVelocity task aborts the following active motion control tasks:

- MC_Home Mode = 3
- MC_Halt
- MC_MoveAbsolute
- MC_MoveRelative
- MC_MoveVelocity
- MC_MoveJog

Note**Behavior with zero set velocity (Velocity = 0.0)**

An MC_MoveVelocity task with "Velocity" = 0.0 (such as an MC_Halt task) aborts active motion tasks and stops the axis with the configured deceleration. When the axis comes to a standstill, output parameter "InVelocity" indicates TRUE for at least one program cycle.

"Busy" indicates the value TRUE during the deceleration operation and changes to FALSE together with "InVelocity". If parameter "Execute" = TRUE is set, "InVelocity" and "Busy" are latched.

When the MC_MoveVelocity task is started, status bit "SpeedCommand" is set in the technology object. Status bit "ConstantVelocity" is set upon axis standstill. Both bits are adapted to the new situation when a new motion task is started.

9.3.5.9 MC_MoveJog (Move axis in jog mode) instruction

Table 9- 43 MC_MoveJog instruction

| LAD / FBD | SCL | Description |
|-----------|---|--|
| | <pre>"MC_MoveJog_DB" (Axis:= _multi_fb_in_, JogForward:= _bool_in_, JogBackward:= _bool_in_, Velocity:= _real_in_, InVelocity=> _bool_out_, Busy=> _bool_out_, CommandAborted=> _bool_out_, Error=> _bool_out_, ErrorID=> _word_out_, ErrorInfo=> _word_out_);</pre> | <p>Use the MC_MoveJog instruction to move the axis constantly at the specified velocity in jog mode. This instruction is typically used for testing and commissioning purposes.</p> <p>In order to use the MC_MoveJog instruction, the axis must first be enabled.</p> |

¹ STEP 7 automatically creates the DB when you insert the instruction.

² In the SCL example, "MC_MoveJog_DB " is the name of the instance DB.

Table 9- 44 Parameters for the MC_MoveJog instruction

| Parameter and type | Data type | Description |
|--------------------------|-----------|-------------|
| Axis | IN | TO_Axis_1 |
| JogForward ¹ | IN | Bool |
| JogBackward ¹ | IN | Bool |
| Velocity | IN | Real |
| InVelocity | OUT | Bool |
| Busy | OUT | Bool |
| CommandAborted | OUT | Bool |
| Error | OUT | Bool |
| ErrorID | OUT | Word |
| ErrorInfo | OUT | Word |

¹ If both the JogForward and JogBackward parameters are simultaneously TRUE, the axis stops with the configured deceleration. An error is indicated in parameters "Error", "ErrorID", and "ErrorInfo".

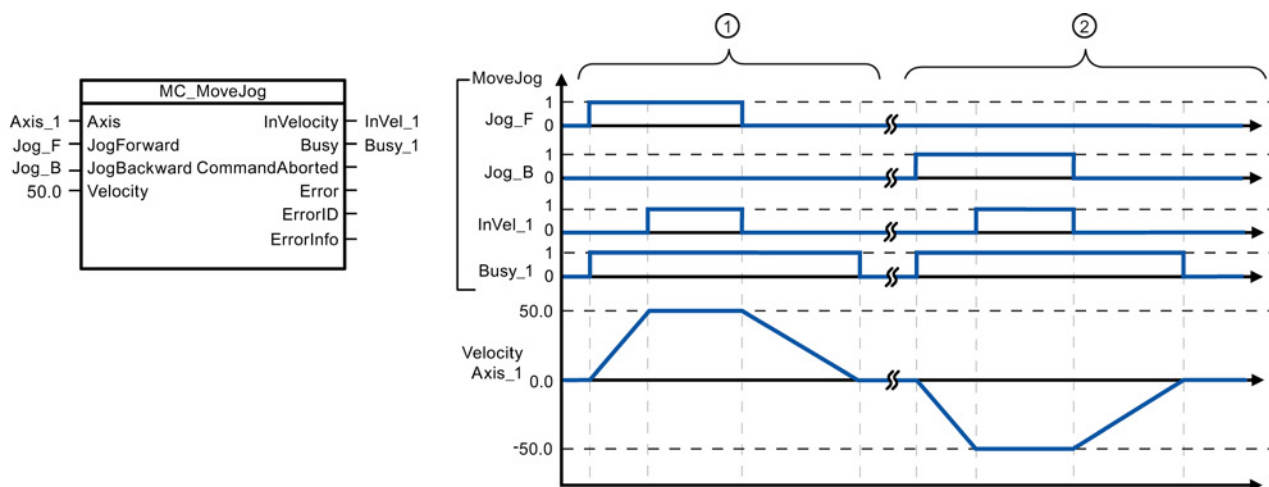

The following values were configured in the "Dynamics > General" configuration window: Acceleration = 10.0 and Deceleration = 5.0

- ① The axis is moved in the positive direction in jog mode via "Jog_F". When the target velocity 50.0 is reached, this is signaled via "InVelo_1". The axis brakes to a standstill again after Jog_F is reset.
- ② The axis is moved in the negative direction in jog mode via "Jog_B". When the target velocity 50.0 is reached, this is signaled via "InVelo_1". The axis brakes to a standstill again after Jog_B is reset.

Override response

The MC_MoveJog task can be aborted by the following motion control tasks:

- MC_Home Mode = 3
- MC_Halt
- MC_MoveAbsolute
- MC_MoveRelative
- MC_MoveVelocity
- MC_MoveJog

The new MC_MoveJog task aborts the following active motion control tasks:

- MC_Home Mode = 3
- MC_Halt
- MC_MoveAbsolute
- MC_MoveRelative
- MC_MoveVelocity
- MC_MoveJog

9.3.5.10 MC_CommandTable (Run axis commands as movement sequence) instruction

Table 9- 45 MC_CommandTable instruction

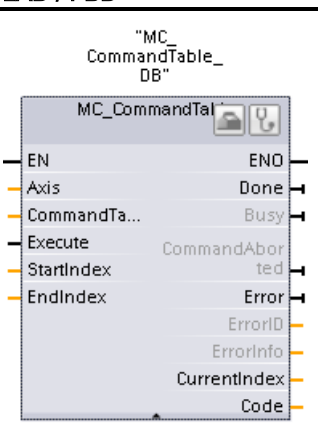
| LAD / FBD | SCL | Description |
|--|---|--|
|  | <pre>"MC_CommandTable_DB" (Axis:= multi_fb_in_, CommandTable:= multi_fb_in_, Execute:= bool_in_, StartIndex:= uint_in_, EndIndex:= uint_in_, Done=> bool_out_, Busy=> bool_out_, CommandAborted=> bool_out_, Error=> bool_out_, ErrorID=> word_out_, ErrorInfo=> word_out_, CurrentIndex=> uint_out_, Code=> word out);</pre> | <p>Executes a series of individual motions for a motor control axis that can combine into a movement sequence.</p> <p>Individual motions are configured in a technology object command table for pulse train output (TO_CommandTable_PTO).</p> |

1 STEP 7 automatically creates the DB when you insert the instruction.

2 In the SCL example, "MC_CommandTable_DB " is the name of the instance DB.

Table 9- 46 Parameters for the MC_CommandTable instruction

| Parameter and type | Data type | Initial value | Description | |
|--------------------|-----------|-------------------|-------------|--|
| Axis | IN | TO_Axis_1 | - | Axis technology object |
| Table | IN | TO_CommandTable_1 | - | Command table technology object |
| Execute | IN | Bool | FALSE | Start job with rising edge |
| StartIndex | IN | Int | 1 | Start command table processing with this step Limits: $1 \leq \text{StartIndex} \leq \text{EndIndex}$ |
| EndIndex | IN | Int | 32 | End command table processing with this step Limits: $\text{StartIndex} \leq \text{EndIndex} \leq 32$ |
| Done | OUT | Bool | FALSE | MC_CommandTable processing completed successfully |

| Parameter and type | Data type | Initial value | Description | |
|--------------------|-----------|---------------|-------------|--|
| Busy | OUT | Bool | FALSE | Operation in progress |
| CommandAborted | OUT | Bool | FALSE | The task was aborted during processing by another task. |
| Error | OUT | Bool | FALSE | An error occurred during processing. The cause is indicated by the parameters ErrorID and ErrorInfo. |
| ErrorID | OUT | Word | 16#0000 | Error identifier |
| ErrorInfo | OUT | Word | 16#0000 | Error information |
| Step | OUT | Int | 0 | Step currently in process |
| Code | OUT | Word | 16#0000 | User defined identifier of the step currently in process |

You can create the desired movement sequence in the "Command Table" configuration window and check the result against the graphic view in the trend diagram.

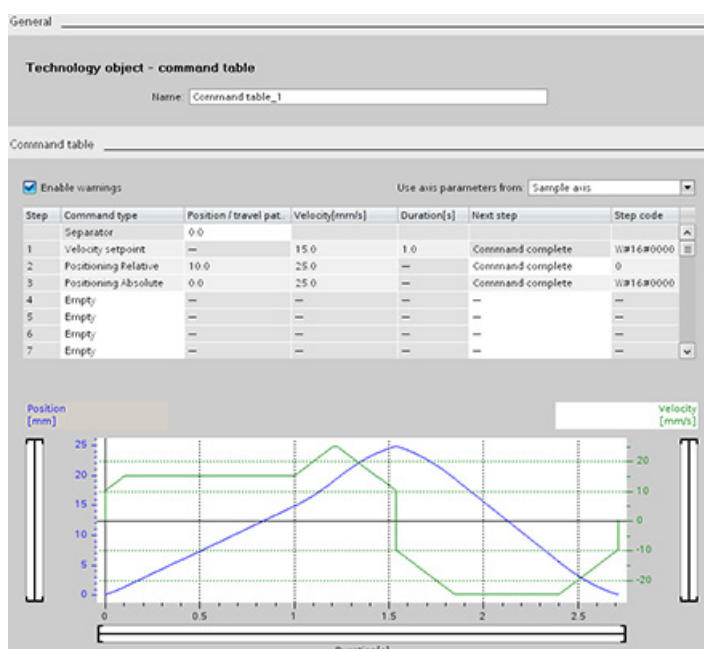

You can select the command types that are to be used for processing the command table. Up to 32 jobs can be entered. The commands are processed in sequence.

Table 9- 47 MC_CommandTable command types

| Command type | Description |
|----------------------|--|
| Empty | The empty serves as a placeholder for any commands to be added. The empty entry is ignored when the command table is processed |
| Halt | Pause axis. Note: The command only takes place after a "Velocity setpoint" command. |
| Positioning Relative | Positions the axis based upon distance. The command moves the axis by the given distance and velocity. |
| Positioning Absolute | Positions the axis based upon location. The command moves the axis to the given location, using the velocity specified. |

| Command type | Description |
|-------------------|---|
| Velocity setpoint | Moves the axis at the given velocity. |
| Wait | Waits until the given period is over. "Wait" does not stop an active traversing motion. |
| Separator | Adds a "Separator" line above the selected line. The separator line allows more than one profile to be defined in a single command table. |

Prerequisites for MC_CommandTable execution:

- The technology object TO_Axis_PTO V2.0 must be correctly configured.
- The technology object TO_CommandTable_PTO must be correctly configured.
- The axis must be released.

Override response

The MC_CommandTable task can be aborted by the following motion control tasks:

- MC_Home Mode = 3
- MC_Halt
- MC_MoveAbsolute
- MC_MoveRelative
- MC_MoveVelocity
- MC_MoveJog
- MC_CommandTable

The new MC_CommandTable task aborts the following active motion control tasks:

- MC_Home Mode = 3
- MC_Halt
- MC_MoveAbsolute
- MC_MoveRelative
- MC_MoveVelocity
- MC_MoveJog
- MC_CommandTable
- The current motion control job with the launch of the first "Positioning Relative", "Positioning Absolute", "Velocity setpoint" or "Halt" command

9.3.5.11 MC_ChangeDynamic (Change dynamic settings for the axis) instruction

Table 9- 48 MC_ChangeDynamic instruction

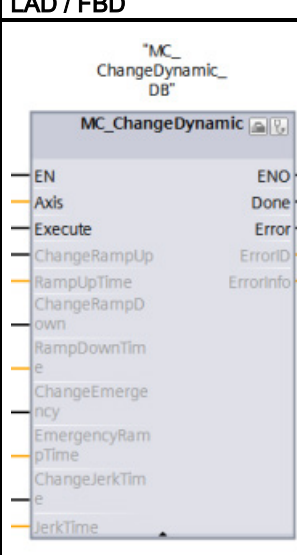
| LAD / FBD | SCL | Description |
|--|--|--|
|  | <pre>"MC_ChangeDynamic_DB" (Execute:=_bool_in_, ChangeRampUp:=_bool_in_, RampUpTime:=_real_in_, ChangeRampDown:=_bool_in_, RampDownTime:=_real_in_, ChangeEmergency:=_bool_in_, EmergencyRampTime:=_real_in_, ChangeJerkTime:=_bool_in_, JerkTime:=_real_in_, Done=>_bool_out_, Error=>_bool_out_, ErrorID=>_word_out_, ErrorInfo=>_word_out_);</pre> | <p>Changes the dynamic settings of a motion control axis:</p> <ul style="list-style-type: none"> • Change the ramp-up time (acceleration) value • Change the ramp-down time (deceleration) value • Change the emergency stop ramp-down time (emergency stop deceleration) value • Change the smoothing time (jerk) value |

- 1 STEP 7 automatically creates the DB when you insert the instruction.
- 2 In the SCL example, "MC_ChangeDynamic_DB " is the name of the instance DB.

Table 9- 49 Parameters for the MC_ChangeDynamic instruction

| Parameter and type | Data type | Description |
|--------------------|-----------|---|
| Axis | IN | TO_Axis_1 Axis technology object |
| Execute | IN | Bool Start of the command with a positive edge. Default value: FALSE |
| ChangeRampUp | IN | Bool TRUE = Change ramp-up time in line with input parameter "RampUpTime". Default value: FALSE |
| RampUpTime | IN | Real Time (in seconds) to accelerate from standstill to the configured maximum velocity without jerk limit. Default value: 5.00 The change will influence the tag <Axis name>. Config.DynamicDefaults.Acceleration. The effectiveness of the change is shown in the description of this tag. |
| ChangeRampDown | IN | Bool TRUE = Change ramp-down time in line with input parameter "RampDownTime". Default value: FALSE |
| RampDownTime | IN | Real Time (in seconds) to decelerate axis from the configured maximum velocity to standstill without jerk limiter. Default value: 5.00 The change will influence the tag <Axis name>. Config.DynamicDefaults.Deceleration. The effectiveness of the change is shown in the description of this tag. |
| ChangeEmergency | IN | Bool TRUE = Change emergency stop ramp-down time in line with input parameter "EmergencyRampTime" Default value: FALSE |

| Parameter and type | | Data type | Description |
|--------------------|-----|-----------|---|
| EmergencyRampTime | IN | Real | Time (in seconds) to decelerate the axis from configured maximum velocity to standstill without jerk limiter in emergency stop mode. Default value: 2.00 The change will influence the tag <Axis name>. Config.DynamicDefaults.EmergencyDeceleration. The effectiveness of the change is shown in the description of this tag. |
| ChangeJerkTime | IN | Bool | TRUE = Change smoothing time according to the input parameter "JerkTime". Default value: FALSE |
| JerkTime | IN | Real | Smoothing time (in seconds) used for the axis acceleration and deceleration ramps. Default value: 0.25 The change will influence the tag <Axis name>. Config.DynamicDefaults.Jerk. The effectiveness of the change is shown in the description of this tag. |
| Done | OUT | Bool | TRUE = The changed values have been written to the technology data block. The description of the tags will show when the change becomes effective. Default value: FALSE |
| Error | OUT | Bool | TRUE = An error occurred during execution of the command. The cause of the error can be found in parameters "ErrorID" and "ErrorInfo". Default value: FALSE |
| ErrorID | OUT | Word | Error identifier. Default value: 16#0000 |
| ErrorInfo | IN | Word | Error information. Default value: 16#0000 |

Prerequisites for MC_ChangeDynamic execution:

- The technology object TO_Axis_PTO V2.0 must be correctly configured.
- The axis must be released.

Override response

An MC_ChangeDynamic command cannot be aborted by any other Motion Control command.

A new MC_ChangeDynamic command does not abort any active Motion Control jobs.

Note

The input parameters "RampUpTime", "RampDownTime", "EmergencyRampTime" and "RoundingOffTime" can be specified with values that makes the resultant axis parameters "acceleration", "delay", "emergency stop-delay" and "jerk" outside the permissible limits.

Make sure you keep the MC_ChangeDynamic parameters within the limits of the dynamic configuration settings for the axis technology object.

9.3.5.12 MC_WriteParam (write parameters of a technology object) instruction

You use the MC_WriteParam instruction to write a select number of parameters to change the functionality of the axis from the user program.

Table 9- 50 MC_WriteParam instruction

| LAD / FBD | SCL | Description |
|-----------|---|--|
| | <pre>"MC_WriteParam_DB" (Parameter:=_variant_in_, Value:=_variant_in_, Execute:=_bool_in_, Done:=_bool_out_, Error:=_real_out_, ErrorID:=_word_out_, ErrorInfo:=_word_out_);</pre> | <p>You use the MC_WriteParam instruction to write to public parameters (for example, acceleration and user DB values).</p> |

- 1 STEP 7 automatically creates the DB when you insert the instruction.
- 2 In the SCL example, "MC_WriteParam_DB" is the name of the instance DB.

You can write to the parameters that are public. You cannot write to "MotionStatus" and "StatusBits". The valid parameters are listed in the table below:

| Writeable parameter name | Writeable parameter name |
|---|---------------------------------------|
| Actor.InverseDirection | DynamicDefaults.Acceleration |
| Actor.DirectionMode | DynamicDefaults.Deceleration |
| Actor.DriveParameter.PulsesPerDriveRevolution | DynamicDefaults.Jerk |
| Sensor[1].ActiveHoming.Mode | DynamicDefaults.EmergencyDeceleration |
| Sensor[1].ActiveHoming.Sidelnput | PositionLimitsHW.Active |
| Sensor[1].ActiveHoming.Offset | PositionLimitsHW.MaxSwitchedLevel |
| Sensor[1].ActiveHoming.SwitchedLevel | PositionLimitsHW.MinSwitchedLevel |
| Sensor[1].PassiveHoming.Mode | PositionLimitsSW.Active |
| Sensor[1].PassiveHoming.Sidelnput | PositionLimitsSW.MinPosition |
| Sensor[1].PassiveHoming.SwitchedLevel | PositionLimitsSW.MaxPosition |
| Units.LengthUnit | Homing.AutoReversal |
| Mechanics.LeadScrew | Homing.ApproachDirection |
| DynamicLimits.MinVelocity | Homing.ApproachVelocity |
| DynamicLimits.MaxVelocity | Homing.ReferencingVelocity |

Table 9- 51 Parameters for the MC_WriteParam instruction

| Parameter and type | | Data type | Description |
|--------------------|-----|-----------|---|
| PARAMNAME | IN | Variant | Name of parameter where value is written |
| VALUE | IN | Variant | Value to write to assigned parameter |
| EXECUTE | IN | Bool | Start the instruction. Default value: FALSE |
| DONE | OUT | Bool | Value has been written. Default value: FALSE |
| BUSY | OUT | Bool | If TRUE, the instruction is operating. Default value: FALSE |
| ERROR | OUT | Real | If TRUE, an error occurred. Default value: FALSE |
| ERRORID | OUT | Word | ID of the error |
| ERRORINFO | OUT | Word | Related information to the ERRORID |

Table 9- 52 Condition codes for ERRORID and ERRORINFO

| ERRORID (W#16#...) | ERRORINFO (W#16#...) | Description |
|--------------------------------|--------------------------------|--|
| 0 | 0 | Successful change of an Axis TO-DB parameter |
| 8410 _[1] | 0028 _[1] | Set an invalid parameter (Axis TO-DB parameter with incorrect length) |
| 8410 _[1] | 0029 _[1] | Set an invalid parameter (no Axis TO-DB parameter) |
| 8410 _[1] | 002B _[1] | Set an Invalid parameter (read-only Axis TO-DB parameter) |
| 8410 _[1] | 002C _[1] | Set a valid parameter, but axis is not disabled |
| Config Error _[2] | Config Error _[2] | Set a valid parameter (public read-only Axis TO-DB parameter) out-of-range |
| Config Error _[3] | Config Error _[3] | Set a valid parameter (public Axis TO-DB parameter) out-of-range |

[1] Error at MC_WriteParam

[2] Error at MC_Power

[3] Error at MC_Power and MC_MoveXXX or MC_CommandTable

9.3.5.13 MC_ReadParam instruction (read parameters of a technology object) instruction

You use the MC_ReadParam instruction to read a select number of parameters that indicate the current position, velocity, and so forth of the axis defined in the Axis input.

Table 9- 53 MC_ReadParam instruction

| LAD / FBD | SCL | Description |
|-----------|--|---|
| | <pre>"MC_ReadParam_DB" (Enable:=_bool_in_, Parameter:=_variant_in_, Value:=_variant_in_out_, Valid:=_bool_out_, Busy:=_bool_out_, Error:=_real_out_, ErrorID:=_word_out_, ErrorInfo:=_word_out_);</pre> | <p>You use the MC_ReadParam instruction to read single status values, independent of the cycle control point.</p> |

- 1 STEP 7 automatically creates the DB when you insert the instruction.
- 2 In the SCL example, "MC_ReadParam_DB " is the name of the instance DB.

The MC_ReadParam instruction works on an enable behavior. As long as the input "Enable" is true the instruction reads the specified "Parameter" to the "Value" storage location.

The "MotionStatus" "Position" value updates at each Cycle Control Point (CCP) based upon the current HSC value.

The "MotionStatus" "Velocity" value is the command velocity at the end of the current segment (updated ~10ms). The MC_ReadParam can also read this value.

If an error occurs, the instruction switches to an error state that can only be reset by a new rising edge at the input "Enable".

Table 9- 54 Parameters for the MC_ReadParam instruction

| Parameter and type | Data type | Description |
|--------------------|-----------|-------------|
| ENABLE | IN | Bool |
| PARAMETER | IN | Variant |
| VALID | OUT | Bool |
| BUSY | OUT | Bool |
| ERROR | OUT | Real |
| ERRORID | OUT | Word |
| ERRORINFO | OUT | Word |
| VALUE | INOUT | Variant |

Table 9- 55 Condition codes for ERRORID and ERRORINFO

| ERRORID (W#16#...) | ERRORINFO (W#16#...) | Description |
|-----------------------|-------------------------|--------------------------------------|
| 0 | 0 | Successful read of a parameter |
| 8410 | 0028 | Invalid parameter (incorrect length) |
| 8410 | 0029 | Invalid parameter (no TO-DB) |
| 8410 | 0030 | Invalid parameter (not readable) |
| 8411 | 0032 | Invalid parameter (wrong value) |

TO parameters

The axis "MotionStatus" consists of four values. You will want to monitor changes in these values, which can be read while the program is running:

| Variable name | Data type | Readable through MC_ReadParam |
|------------------|-----------|----------------------------------|
| MotionStatus: | Structure | No |
| • Position | REAL | Yes |
| • Velocity | REAL | Yes |
| • Distance | REAL | Yes |
| • TargetPosition | REAL | Yes |

9.3.6 Operation of motion control for S7-1200

9.3.6.1 CPU outputs used for motion control

The CPU provides four pulse output generators. Each pulse output generator provides one pulse output and one direction output for controlling a stepper motor drive or a servo motor drive with pulse interface. The pulse output provides the drive with the pulses required for motor motion. The direction output controls the travel direction of the drive.

The PTO output generates a square wave output of variable frequency. Pulse generation is controlled by configuration and execution information supplied through H/W configuration and/or SFCs/SFBs.

Based upon the user's selection while the CPU is in RUN mode, either the values stored in the image register or the pulse generator outputs drive the digital outputs. In STOP mode, the PTO generator does not control the outputs.

Onboard CPU outputs and outputs of a signal board can be used as pulse and direction outputs. You select between onboard CPU outputs and outputs of the signal board during device configuration under Pulse generators (PTO/PWM) on the "Properties" tab. Only PTO (Pulse Train Output) applies to motion control.

The table below shows the default I/O assignments; however, the four pulse generators can be configured to any digital output.

Note

Pulse-train outputs cannot be used by other instructions in the user program.

When you configure the outputs of the CPU or signal board as pulse generators (for use with the PWM or motion control instructions), the corresponding output addresses no longer control the outputs. If your user program writes a value to an output used as a pulse generator, the CPU does not write that value to the physical output.

Note

PTO direction outputs can be freed for use elsewhere in your program.

Each PTO requires the assignment of two outputs: one as a pulse output and one as a direction output. You can use just the pulse output and not the direction output. You can then free the direction output for other purposes in your user program. The output cannot be used for both the PTO direction output and in the user program, simultaneously.

Table 9- 56 Default address assignments of the pulse and direction outputs

| Usage of outputs for motion control | | |
|-------------------------------------|-------------------|-------------------|
| | Pulse | Direction |
| PTO1 | | |
| Built-in I/O | Q0.0 | Q0.1 |
| SB I/O | Q4.0 | Q4.1 |
| PTO2 | | |
| Built-in I/O | Q0.2 | Q0.3 |
| SB I/O | Q4.2 | Q4.3 |
| PTO3 | | |
| Built-in I/O | Q0.4 ¹ | Q0.5 ¹ |
| SB I/O | Q4.0 | Q4.1 |
| PTO4 | | |
| Built-in I/O | Q0.6 ² | Q0.7 ² |
| SB I/O | Q4.2 | Q4.3 |

- 1 The CPU 1211C does not have outputs Q0.4, Q0.5, Q0.6, or Q0.7. Therefore, these outputs cannot be used in the CPU 1211C.
- 2 The CPU 1212C does not have outputs Q0.6 or Q0.7. Therefore, these outputs cannot be used in the CPU 1212C.
- 3 This table applies to the CPU 1211C, CPU 1212C, CPU 1214C, CPU 1215C, and CPU 1217C PTO functions.

Drive interface

For motion control, you can optionally configure a drive interface for "Drive enabled" and "Drive ready". When using the drive interface, the digital output for the drive enable and the digital input for "drive ready" can be freely selected.

Note

The firmware will take control through the corresponding pulse and direction outputs if the PTO (Pulse Train Output) has been selected and assigned to an axis.

With this takeover of the control function, the connection between the process image and I/O output is also disconnected. While the user has the possibility of writing the process image of pulse and direction outputs via the user program or watch table, this is never transferred to the I/O output. Accordingly, it is also not possible to monitor the I/O output via the user program or watch table. The information read merely reflects the value of the process image and does not match the actual status of the I/O output in any respect.

For all other CPU outputs that are not used permanently by the CPU firmware, the status of the I/O output can be controlled or monitored via the process image, as usual.

9.3.6.2 Hardware and software limit switches for motion control

Use the hardware and software limit switches to limit the "allowed travel range" and the "working range" of your axis.

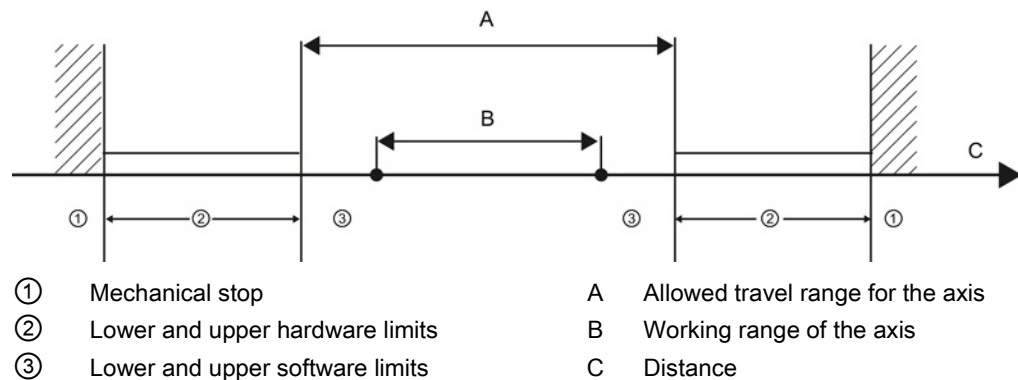

Hardware and software limit switches must be activated prior to use in the configuration or in the user program. Software limit switches are only active after homing the axis.

Hardware limit switches

Hardware limit switches determine the maximum travel range of the axis. Hardware limit switches are physical switching elements that must be connected to interrupt-capable inputs of the CPU. Use only hardware limit switches that remain permanently switched after being approached. This switching status may only be revoked after a return to the allowed travel range.

Table 9- 57 Available inputs for hardware limits

| Description | RPS | LIM- | LIM+ |
|--------------|-----|-------------|------|
| Built-in I/O | | 10.0 - 11.5 | |
| SB I/O | | 14.0 - 14.3 | |

When the hardware limit switches are approached, the axis brakes to a standstill at the configured emergency deceleration. The specified emergency deceleration must be sufficient to reliably stop the axis before the mechanical stop. The following diagram presents the behavior of the axis after it approaches the hardware limit switches.

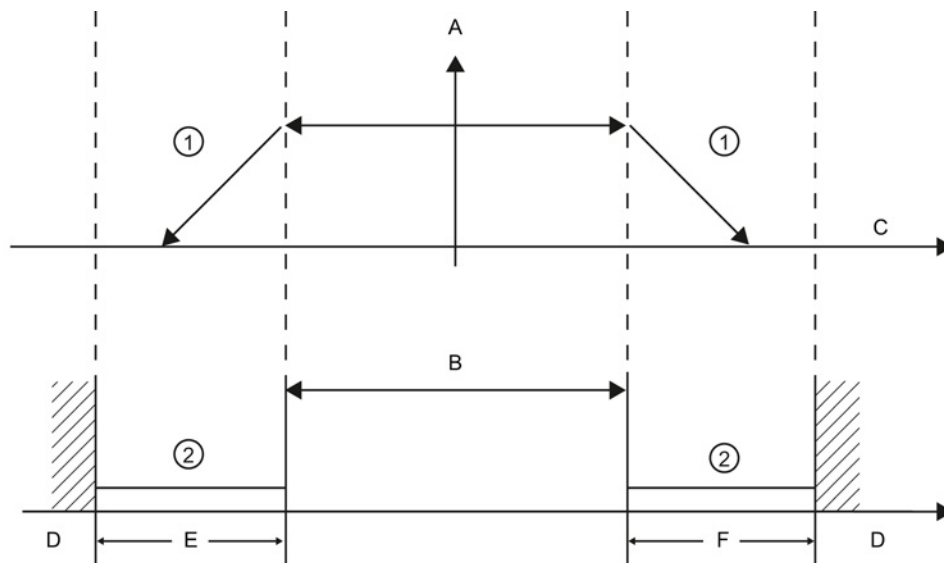

- ① The axis brakes to a standstill at the configured emergency deceleration.
- ② Range in which the hardware limit switches signal the status "approached".
- A [Velocity]
- B Allowed travel range
- C Distance
- D Mechanical stop
- E Lower hardware limit switch
- F Upper hardware limit switch

⚠ WARNING**Risks with changes to filter time for digital input channel**

If the filter time for a digital input channel is changed from a previous setting, a new "0" level input value may need to be presented for up to 20.0 ms accumulated duration before the filter becomes fully responsive to new inputs. During this time, short "0" pulse events of duration less than 20.0 ms may not be detected or counted.

This changing of filter times can result in unexpected machine or process operation, which may cause death or serious injury to personnel, and/or damage to equipment.

To ensure that a new filter time goes immediately into effect, a power cycle of the CPU must be applied.

Software limit switches

Software limit switches limit the "working range" of the axis. They should fall inside the hardware limit switches relative to the travel range. Because the positions of the software limit switches can be set flexibly, the working range of the axis can be restricted on an individual basis depending on the current traversing profile. In contrast to hardware limit switches, software limit switches are implemented exclusively by means of the software and do not require their own switching elements.

If software limit switches are activated, an active motion is stopped at the position of the software limit switch. The axis is braked at the configured deceleration. The following diagram presents the behavior of the axis until it reaches the software limit switches.

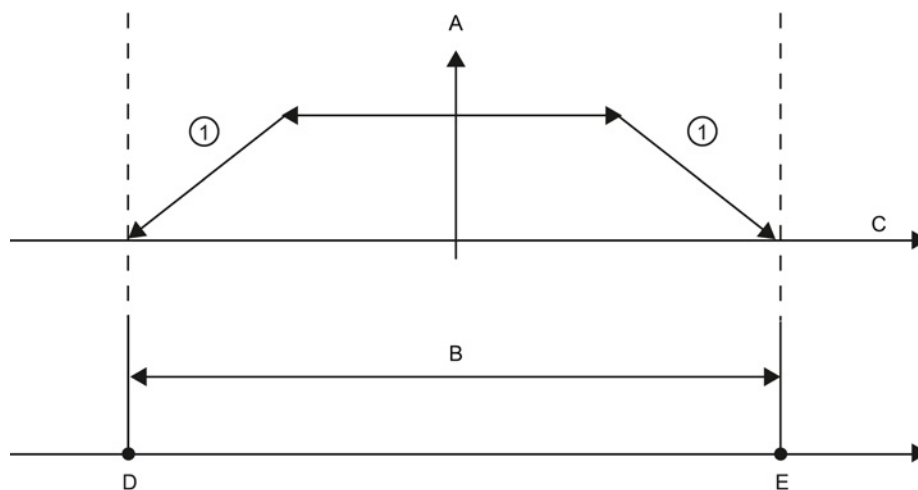

- ① The axis brakes to a standstill at the configured deceleration.
- A [Velocity]
- B Working range
- C Distance
- D Lower software limit switch
- E Upper software limit switch

Use additional hardware limit switches if a mechanical endstop is located after the software limit switches and there is a risk of mechanical damage.

Additional information

Your user program can override the hardware or software position limits by enabling or disabling both hardware and software limits functionality. The selection is made from the Axis DB.

- To enable or disable the hardware limit functionality, access the "Active" tag (Bool) in the DB path "<axis name>/Config/PositionLimits_HW". The state of the "Active" tag enables or disables the use of hardware position limits.
- To enable or disable software position limit functionality, access "Active" tag (Bool) in the DB path "<axis name>/Config/Position Limits_SW". The state of this "Active" tag enables or disables the software position limits.

You can also modify the software position limits with your user program (for example, to add flexibility for machine setup or to shorten machine change-over time). Your user program can write new values to the " MinPosition " and " MaxPosition " tags (engineering units in Real format) in the DB "<axis name>/Config/PositionLimits_SW".

9.3.6.3 Homing

Homing refers to the matching of the axis coordinates to the real, physical drive position. (If the drive is currently at position x, the axis will be adjusted to be in position x.) For position-controlled axes, the entries and displays for the position refer exactly to these axis coordinates.

Note

The agreement between the axis coordinates and the real situation is extremely important. This step is necessary to ensure that the absolute target position of the axis is also achieved exactly with the drive.

The MC_Home instruction initiates the homing of the axis.

There are 4 different homing functions. The first two functions allow the user to set the current position of the axis and the second two position the axis with respect to a Home reference Sensor.

- **Mode 0 - Direct Referencing Absolute:** When executed this mode tells the axis exactly where it is. It sets the internal position variable to the value of the Position input of the Homing instruction. This is used for machine calibration and setup.

The axis position is set regardless of the reference point switch. Active traversing motions are not aborted. The value of the Position input parameter of the MC_Home instruction is set immediately as the reference point of the axis. To assign the reference point to an exact mechanical position, the axis must be at a standstill at this position at the time of the homing operation.

- **Mode 1 - Direct Referencing Relative:** When executed this mode uses the internal position variable and adds the value of the Position input on the Homing instruction to it. This is typically used to account for machine offset.

The axis position is set regardless of the reference point switch. Active traversing motions are not aborted. The following statement applies to the axis position after homing: New axis position = current axis position + value of the Position parameter of the MC_Home instruction.

- **Mode 2 - Passive Referencing:** When the axis is moving and passes the Reference Point Switch the current position is set as the home position. This feature will help account for normal machine wear and gear backlash and prevent the need for manual compensation for wear. The Position input on the Homing instruction, as before, adds to the location indicated by the Reference Point Switch allowing easy offset of the Home position.

During passive homing, the MC_Home instruction does not carry out any homing motion. The traversing motion required for this step must be implemented by the user via other motion control instructions. When the reference point switch is detected, the axis is homed according to the configuration. Active traversing motions are not aborted upon start of passive homing.

- **Mode 3 - Active Referencing:** This mode is the most precise method of Homing the Axis. The initial direction and velocity of movement is configured in the Technology Object Configuration Extended Parameters-Homing. This is dependent upon machine configuration. There is also the ability to determine if the leading edge or falling edge of the Reference Point Switch signal is the Home position. Virtually all sensors have an active range and if the Steady State On position was used as the Home signal then there would be a possibility for error in the Homing position since the On signal active range would cover a range of distance. By using either the leading or falling edge of that signal a much more precise Home position results. As with all other modes the value of the Position input on the Homing instruction is added to the Hardware referenced position.

In active homing mode, the MC_Home instruction performs the required reference point approach. When the reference point switch is detected, the axis is homed according to the configuration. Active traversing motions are aborted.

Modes 0 and 1 do not require that the axis be moved at all. They are typically used in setup and calibration. Modes 2 and 3 require that the axis move and pass a sensor that is configured in the "Axis" technology object as the Reference Point Switch. The reference point can be placed in the work area of the axis or outside of the normal work area but within movement range.

Configuration of homing parameters

Configure the parameters for active and passive homing in the "Homing" configuration window. The homing method is set using the "Mode" input parameter of the motion control instruction. Here, Mode = 2 means passive homing and Mode = 3 means active homing.

Note

Use one of the following measures to ensure that the machine does not travel to a mechanical endstop in the event of a direction reversal:

- Keep the approach velocity low
 - Increase the configured acceleration/deceleration
 - Increase the distance between hardware limit switch and mechanical stop
-

Table 9- 58 Configuration parameters for homing the axis

| Parameter | Description |
|---|---|
| Input reference point switch (Active and passive homing) | Select the digital input for the reference point switch from the drop-down list box. The input must be interrupt-capable. The onboard CPU inputs and inputs of an inserted signal board can be selected as inputs for the reference point switch. The default filter time for the digital inputs is 6.4 ms. When the digital inputs are used as a reference point switch, this can result in undesired decelerations and thus inaccuracies. Depending on the reduced velocity and extent of the reference point switch, the reference point may not be detected. The filter time can be set under "Input filter" in the device configuration of the digital inputs. The specified filter time must be less than the duration of the input signal at the reference point switch. |
| Auto reverse after reaching the hardware limit switches (Active homing only) | Activate the check box to use the hardware limit switch as a reversing cam for the reference point approach. The hardware limit switches must be configured and activated for direction reversal. If the hardware limit switch is reached during active homing, the axis brakes at the configured deceleration (not with the emergency deceleration) and reverses direction. The reference point switch is then sensed in reverse direction. If the direction reversal is not active and the axis reaches the hardware limit switch during active homing, the reference point approach is aborted with an error and the axis is braked at the emergency deceleration. |
| Approach direction (Active and passive homing) | With the direction selection, you determine the "approach direction" used during active homing to search for the reference point switch, as well as the homing direction. The homing direction specifies the travel direction the axis uses to approach the configured side of the reference point switch to carry out the homing operation. |

| Parameter | Description |
|---|---|
| Reference point switch (Active and passive homing) | <ul style="list-style-type: none"> Active homing: Select whether the axis is to be referenced on the left or right side of the reference point switch. Depending on the start position of the axis and the configuration of the homing parameters, the reference point approach sequence can differ from the diagram in the configuration window. Passive homing: With passive homing, the traversing motions for purposes of homing must be implemented by the user via motion commands. The side of the reference point switch on which homing occurs depends on the following factors: <ul style="list-style-type: none"> "Approach direction" configuration "Reference point switch" configuration Current travel direction during passive homing |
| Approach velocity (Active homing only) | Specify the velocity at which the reference point switch is to be searched for during the reference point approach. Limit values (independent of the selected user unit): Start/stop velocity \leq approach velocity \leq maximum velocity |
| Reduced velocity (Active homing only) | Specify the velocity at which the axis approaches the reference point switch for homing. Limit values (independent of the selected user unit): Start/stop velocity \leq reduced velocity \leq maximum velocity |
| Home position offset (Active homing only) | If the desired reference position deviates from the position of the reference point switch, the home position offset can be specified in this field. If the value does not equal 0, the axis executes the following actions following homing at the reference point switch: <ol style="list-style-type: none"> Move the axis at reduced velocity by the value of the home position offset. When the position of the home position offset is reached, the axis position is set to the absolute reference position. The absolute reference position is specified via parameter "Position" of motion control instruction "MC_Home". Limit values (independent of the selected user unit): -1.0e12 \leq home position offset \leq 1.0e12 |

Table 9- 59 Factors that affect homing

| Influencing factors: | | | Result: |
|-------------------------------------|---|--------------------------|-------------------------------------|
| Configuration Approach direction | Configuration Reference point switch | Current travel direction | Homing on Reference point switch |
| Positive | "Left (negative) side" | Positive direction | Left |
| | | Negative direction | Right |
| Positive | "Right (positive) side" | Positive direction | Right |
| | | Negative direction | Left |
| Negative | "Left (negative) side" | Positive direction | Right |
| | | Negative direction | Left |
| Negative | "Right (positive) side" | Positive direction | Left |
| | | Negative direction | Right |

Sequence for active homing

You start active homing with motion control instruction "MC_Home" (input parameter Mode = 3). Input parameter "Position" specifies the absolute reference point coordinates in this case. Alternatively, you can start active homing on the control panel for test purposes.

The following diagram shows an example of a characteristic curve for an active reference point approach with the following configuration parameters:

- "Approach direction" = "Positive approach direction"
- "Reference point switch" = "Right (positive) side"
- Value of "home position offset" > 0

Table 9- 60 Velocity characteristics of MC homing

| Operation | | Notes | |
|-----------|---|-------|--------------------------|
| | | A | Approach velocity |
| | | B | Reduced velocity |
| | | C | Home position coordinate |
| | | D | Home position offset |
| ① | Search phase (blue curve segment): When active homing starts, the axis accelerates to the configured "approach velocity" and searches at this velocity for the reference point switch. | | |
| ② | Reference point approach (red curve section): When the reference point switch is detected, the axis in this example brakes and reverses, to be homed on the configured side of the reference point switch at the configured "reduced velocity". | | |
| ③ | Travel to reference point position (green curve segment): After homing at the reference point switch, the axis travels to the "Reference point coordinates" at the "reduced velocity". On reaching the "Reference point coordinates", the axis is stopped at the position value that was specified in the Position input parameter of the MC_Home instruction". | | |

Note

If the homing search does not function as you expected, check the inputs assigned to the hardware limits or to the reference point. These inputs may have had their edge interrupts disabled in device configuration.

Examine the configuration data for the axis technology object of concern to see which inputs (if any) are assigned for "HW Low Limit Switch Input", "HW High Limit Switch Input", and "Input reference point switch". Then open the Device configuration for the CPU and examine each of the assigned inputs. Verify the "Enable rising edge detection" and "Enable falling edge detection" are both selected. If these properties are not selected, delete the specified inputs in the axis configuration and select them again.

9.3.6.4 Jerk limit

With the jerk limit you can reduce the stresses on your mechanics during an acceleration and deceleration ramp. The value for the acceleration and deceleration is not changed abruptly when the step limiter is active; it is adapted in a transition phase. The figure below shows the velocity and acceleration curve without and with jerk limit.

Table 9- 61 Jerk limit

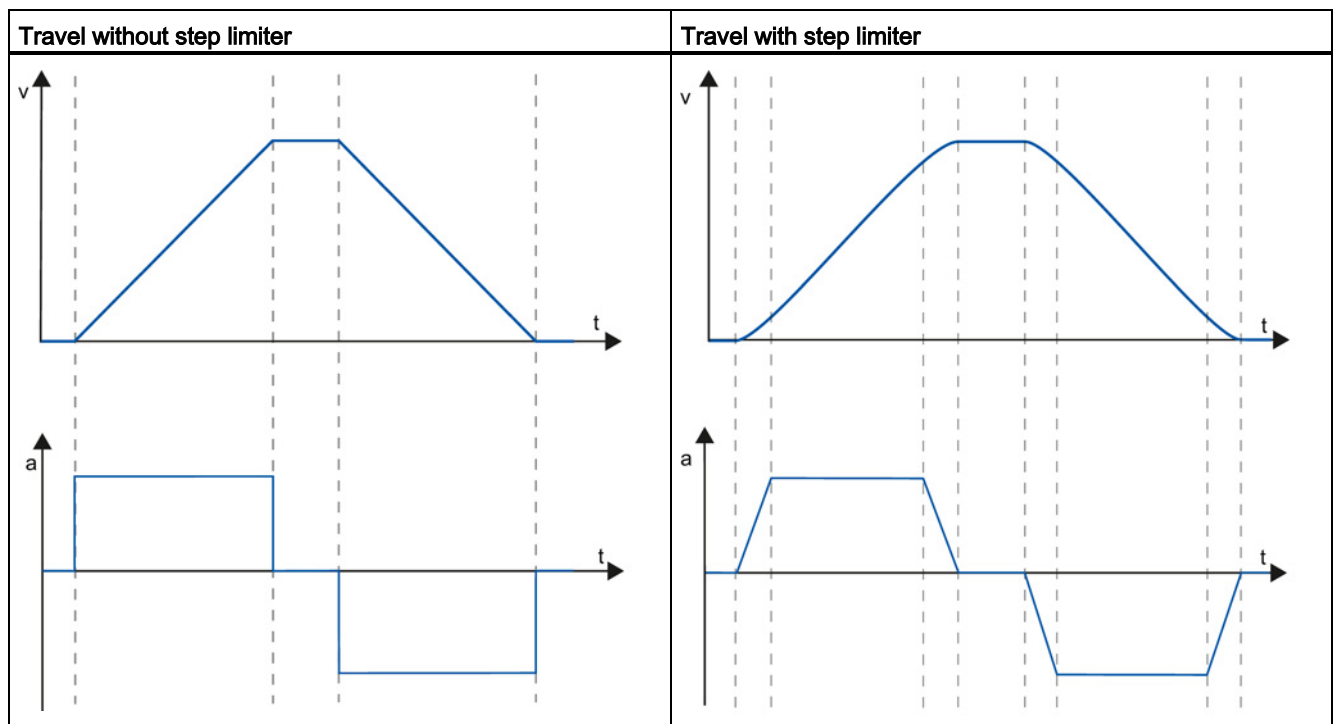

The jerk limit gives a "smoothed" velocity profile of the axis motion. This ensures soft starting and braking of a conveyor belt for example.

9.3.7 Commissioning

"Status and error bits" diagnostic function

Use the "Status and error bits" diagnostic function to monitor the most important status and error messages for the axis. The diagnostic function display is available in online mode in "Manual control" mode and in "Automatic control" when the axis is active.

Table 9- 62 Status of the axis

| Status | Description |
|----------------------|--|
| Enabled | The axis is enabled and ready to be controlled via motion control tasks. (Tag of technology object: <Axis name>.StatusBits.Enable) |
| Homed | The axis is homed and is capable of executing absolute positioning tasks of motion control instruction "MC_MoveAbsolute". The axis does not have to be homed for relative homing. Special situations: <ul style="list-style-type: none"> • During active homing, the status is FALSE. • If a homed axis undergoes passive homing, the status is set to TRUE during passive homing. (Tag of technology object: <Axis name>.StatusBits.HomingDone) |
| Error | An error has occurred in the "Axis" technology object. More information about the error is available in automatic control at the ErrorID and ErrorInfo parameters of the motion control instructions. In manual mode, the "Last error" field of the control panel displays detailed information about the cause of error. (Tag of technology object: <Axis name>.StatusBits.Error) |
| Control panel active | The "Manual control" mode was enabled in the control panel. The control panel has control priority over the "Axis" technology object. The axis cannot be controlled from the user program. (Tag of technology object: <Axis name>.StatusBits.ControlPanelActive) |

Table 9- 63 Drive status

| Status | Description |
|-------------|--|
| Drive ready | The drive is ready for operation. (Tag of technology object: <Axis name>.StatusBits.DriveReady) |
| Error | The drive has reported an error after failure of its ready signal. (Tag of technology object: <Axis name>.ErrorBits.DriveFault) |

Table 9- 64 Status of the axis motion

| Status | Description |
|--------------|---|
| Standstill | The axis is at a standstill. (Tag of technology object: <Axis name>.StatusBits.StandStill) |
| Accelerating | The axis accelerates. (Tag of technology object: <Axis name>.StatusBits.Acceleration) |

| Status | Description |
|-------------------|---|
| Constant velocity | The axis travels at constant velocity. (Tag of technology object: <Axis name>.StatusBits.ConstantVelocity) |
| Decelerating | The axis decelerates (slows down). (Tag of technology object: <Axis name>.StatusBits.Deceleration) |

Table 9- 65 Status of the motion mode

| Status | Description |
|---------------|---|
| Positioning | The axis executes a positioning task of motion control instruction "MC_MoveAbsolute" or "MC_MoveRelative" or of the control panel. (Tag of technology object: <Axis name>.StatusBits.PositioningCommand) |
| Speed Command | The axis executes a task at set speed of motion control instruction "MC_MoveVelocity" or "MC_MoveJog" or of the control panel. (Tag of technology object: <Axis name>.StatusBits.SpeedCommand) |
| Homing | The axis executes a homing task of motion control instruction "MC_Home" or the control panel. (Tag of technology object: <Axis name>.StatusBits.Homing) |

Table 9- 66 Error bits

| Error | Description |
|-----------------------------|---|
| Min software limit reached | The lower software limit switch has been reached. (Tag of technology object: <Axis name>.ErrorBits.SwLimitMinReached) |
| Min software limit exceeded | The lower software limit switch has been exceeded. (Tag of technology object: <Axis name>.ErrorBits.SwLimitMinExceeded) |
| Max software limit reached | The upper software limit switch has been reached. (Tag of technology object: <Axis name>.ErrorBits.SwLimitMaxReached) |
| Max software limit exceeded | The upper software limit switch has been exceeded. (Tag of technology object: <Axis name>.ErrorBits.SwLimitMaxExceeded) |
| Negative hardware limit | The lower hardware limit switch has been approached. (Tag of technology object: <Axis name>.ErrorBits.HwLimitMin) |
| Positive hardware limit | The upper hardware limit switch has been approached. (Tag of technology object: <Axis name>.ErrorBits.HwLimitMax) |
| PTO already used | A second axis is using the same PTO and is enabled with "MC_Power". (Tag of technology object: <Axis name>.ErrorBits.HwUsed) |
| Configuration error | The "Axis" technology object was incorrectly configured or editable configuration data were modified incorrectly during runtime of the user program. (Tag of technology object: <Axis name>.ErrorBits.ConfigFault) |
| General Error | An internal error has occurred. (Tag of technology object: <Axis name>.ErrorBits.SystemFault) |

"Motion status" diagnostic function

Use the "Motion status" diagnostic function to monitor the motion status of the axis. The diagnostic function display is available in online mode in "Manual control" mode and in "Automatic control" when the axis is active.

Table 9- 67 Motion status

| Status | Description |
|------------------|---|
| Target position | The "Target position" field indicates the current target position of an active positioning task of motion control instruction "MC_MoveAbsolute" or "MC_MoveRelative" or of the control panel. The value of the "Target position" is only valid during execution of a positioning task. (Tag of technology object: <Axis name>.MotionStatus.TargetPosition) |
| Current position | The "Current position" field indicates the current axis position. If the axis is not homed, the value indicates the position value relative to the enable position of the axis. (Tag of technology object: <Axis name>.MotionStatus.Position) |
| Current velocity | The "Current velocity" field indicates the actual axis velocity. (Tag of technology object: <Axis name>.MotionStatus.Velocity) |

Table 9- 68 Dynamic limits

| Dynamic limit | Description |
|---------------|--|
| Velocity | The "Velocity" field indicates the configured maximum velocity of the axis. (Tag of technology object: <Axis name>.Config.DynamicLimits.MaxVelocity) |
| Acceleration | The "Acceleration" field indicates the currently configured acceleration of the axis. (Tag of technology object: <Axis name>.Config.DynamicDefaults.Acceleration) |
| Deceleration | The "Deceleration" field indicates the currently configured deceleration of the axis. (Tag of technology object: <Axis name>.Config.DynamicDefaults.Deceleration) |

Motion start value control

You can edit the actual values of the Motion configuration parameters so that the behavior of the process can be optimized in online mode.

Open the "Technology objects" for your motion control and its "Configuration" object. To access the start value control, click the "eyeglasses icon" in the upper left corner of the dialog:

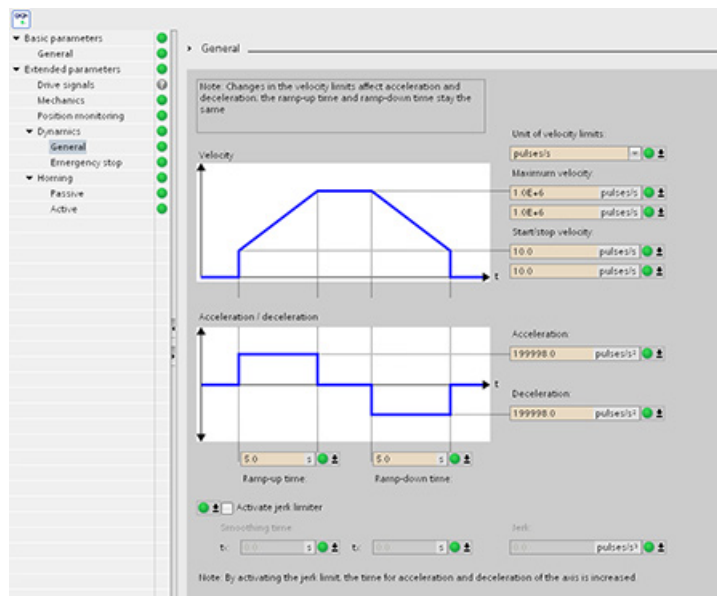

You can now change the value of any of your motion control configuration parameters as shown in the figure below.

You can compare the actual value to the project (offline) start value and the PLC (online) start value of each parameter. This is necessary to compare online/offline differences of the Technology object data block (TO-DB) and to be informed about the values that will be used as current values on the next Stop-to-Start transition of the PLC. In addition, a compare icon gives a visual indication to help easily identify online/offline differences.

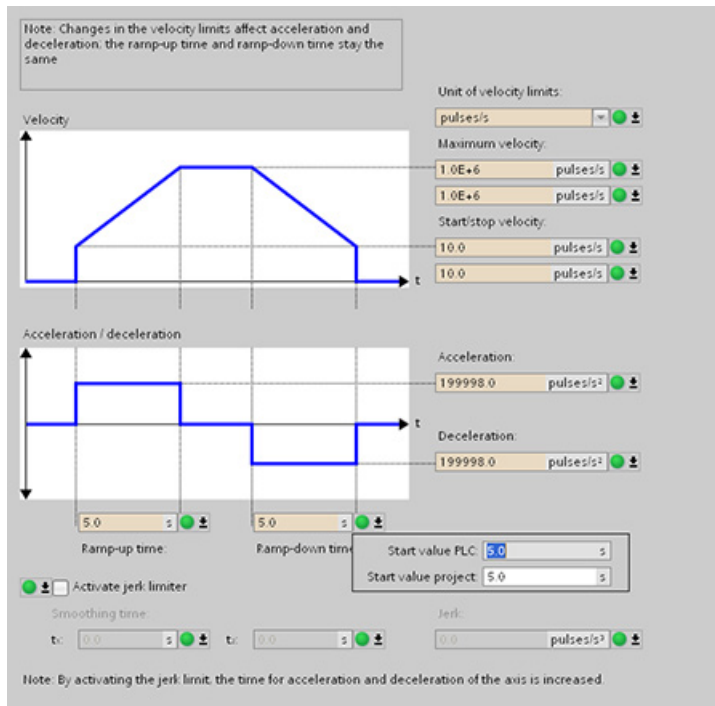

The figure above shows the Motion parameter screen with compare icons showing which values are different between online and offline projects. A green icon indicates that the values are the same; a blue/orange icon indicates that the values are different.

Additionally, click the parameter button with the downward arrow to open a small window that shows the project (offline) start value and the PLC (online) start value of each parameter.

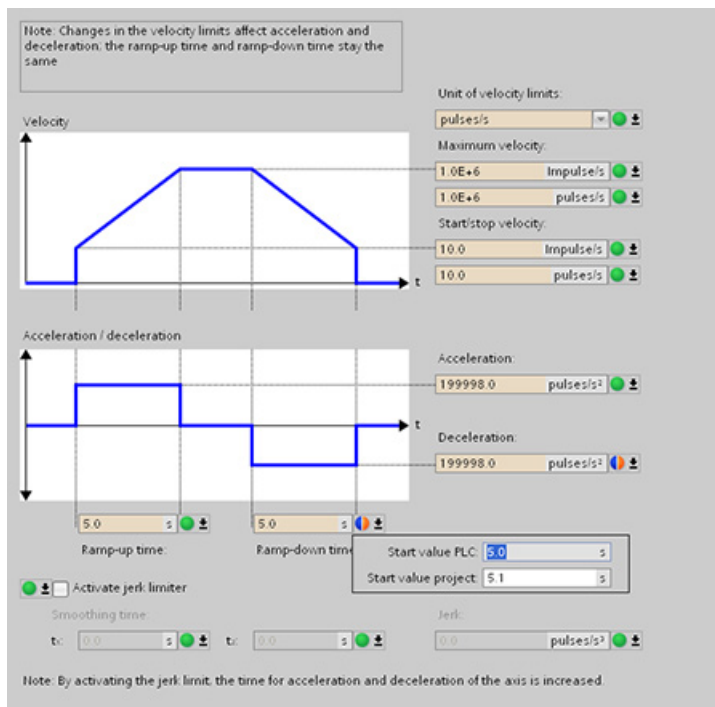

9.3.8 Monitoring active commands

9.3.8.1 Monitoring MC instructions with a "Done" output parameter

Motion control instructions with the output parameter "Done" are started by the input parameter "Execute" and have a defined conclusion (for example, with motion control instruction "MC_Home": Homing was successful). The task is complete and the axis is at a standstill.

- The output parameter "Done" indicates the value TRUE, if the task has been successfully completed.
- The output parameters "Busy", "CommandAborted", and "Error" signal that the task is still being processed, has been aborted or an error is pending. The motion control instruction "MC_Reset" cannot be aborted and thus has no "CommandAborted" output parameter.
 - During processing of the motion control task, the output parameter "Busy" indicates the value TRUE. If the task has been completed, aborted, or stopped by an error, the output parameter "Busy" changes its value to FALSE. This change occurs regardless of the signal at input parameter "Execute".
 - Output parameters "Done", "CommandAborted", and "Error" indicate the value TRUE for at least one cycle. These status messages are latched while input parameter "Execute" is set to TRUE.

The tasks of the following motion control instructions have a defined conclusion:

- MC_Reset
- MC_Home
- MC_Halt
- MC_MoveAbsolute
- MC_MoveRelative

The behavior of the status bits is presented below for various example situations.

- The first example shows the behavior of the axis for a completed task. If the motion control task has been completely executed by the time of its conclusion, this is indicated by the value TRUE in output parameter "Done". The signal status of input parameter "Execute" influences the display duration in the output parameter "Done".
- The second example shows the behavior of the axis for an aborted task. If the motion control task is aborted during execution, this is indicated by the value TRUE in output parameter "CommandAborted". The signal status of the input parameter "Execute" influences the display duration in the output parameter "CommandAborted".
- The third example shows the behavior of the axis if an error occurs. If an error occurs during execution of the motion control task, this is indicated by the value TRUE in the output parameter "Error". The signal status of the input parameter "Execute" influences the display duration in the output parameter "Error".

Table 9- 69 Example 1 - Complete execution of task

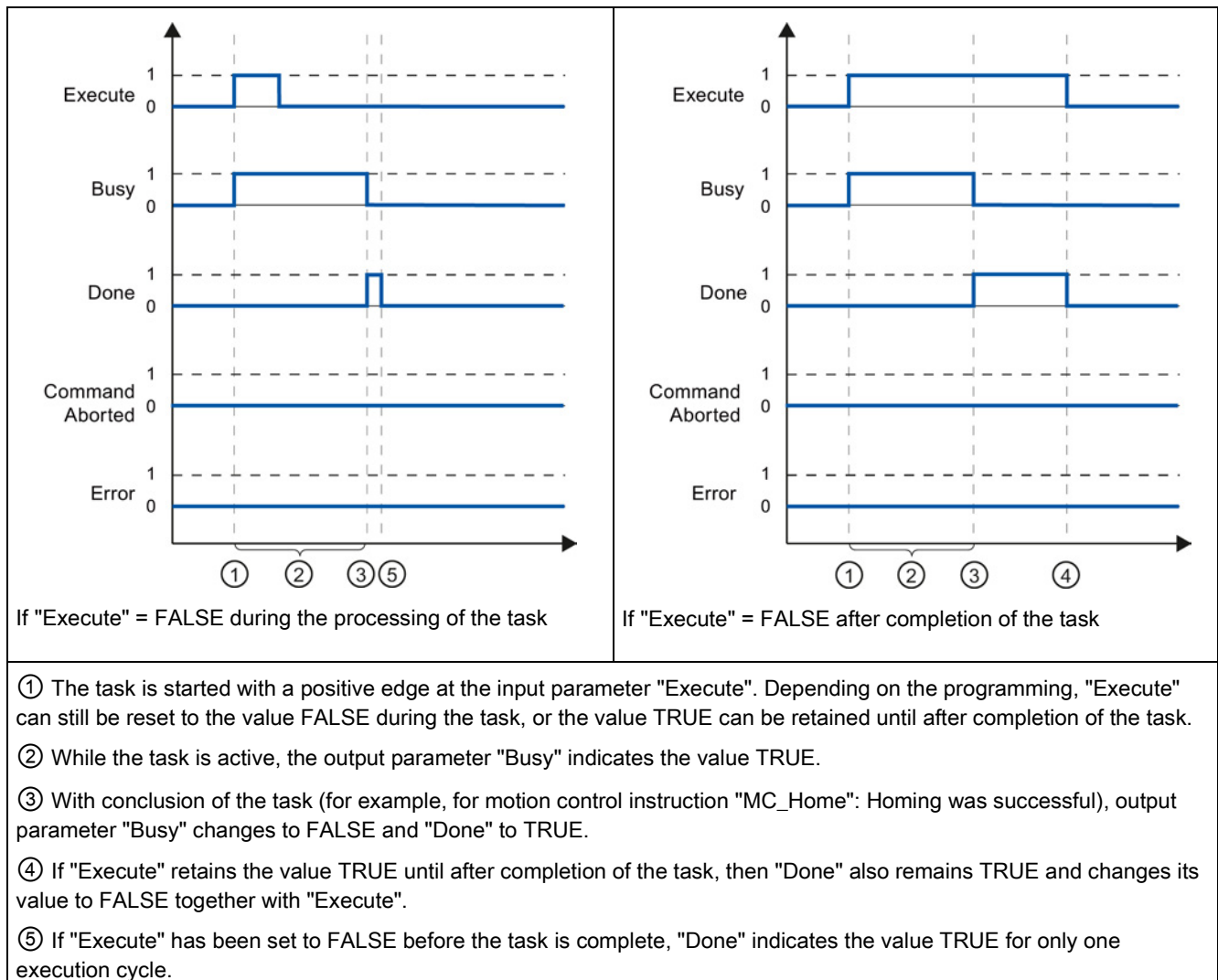

Table 9- 70 Example 2 - Aborting the task

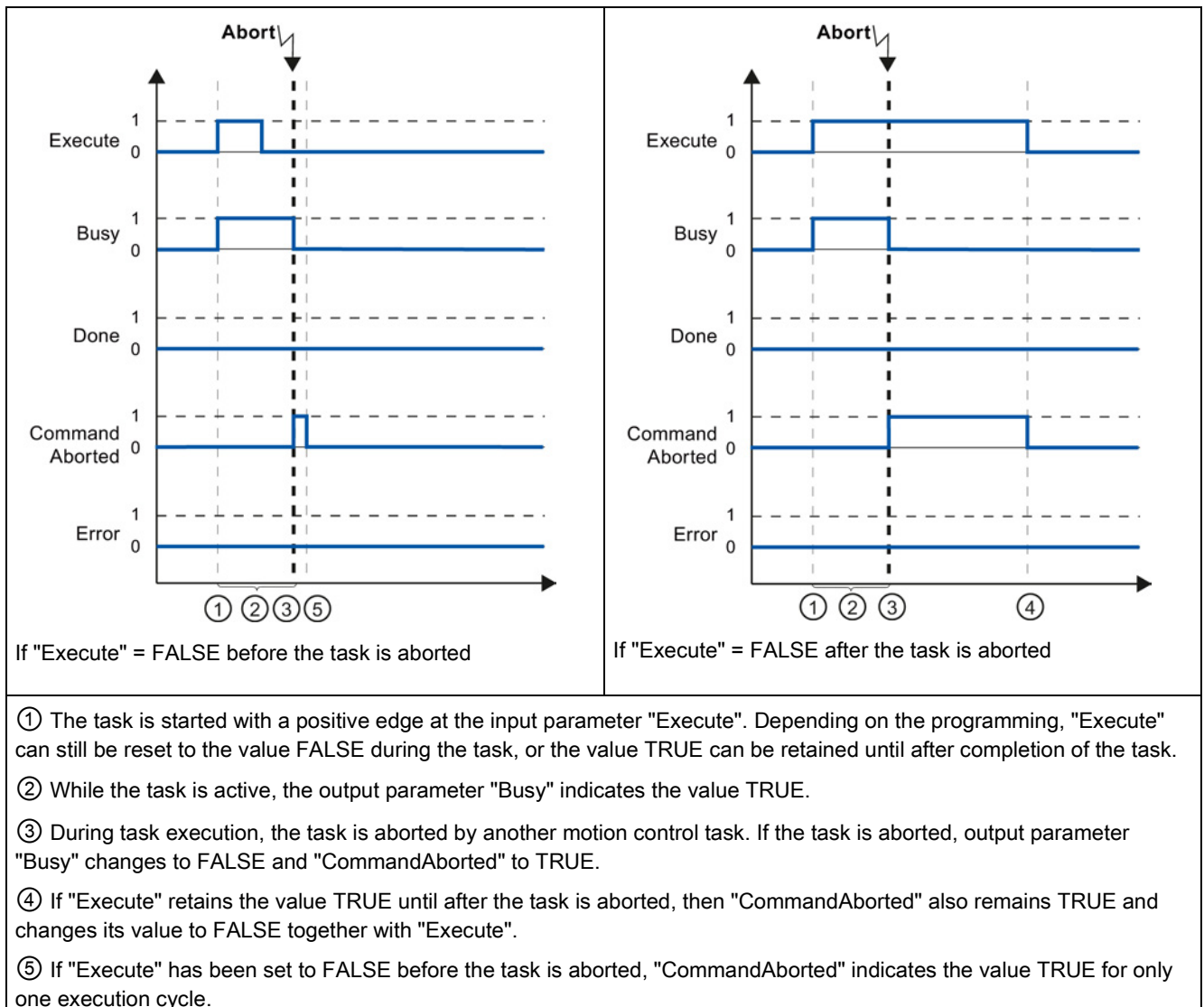
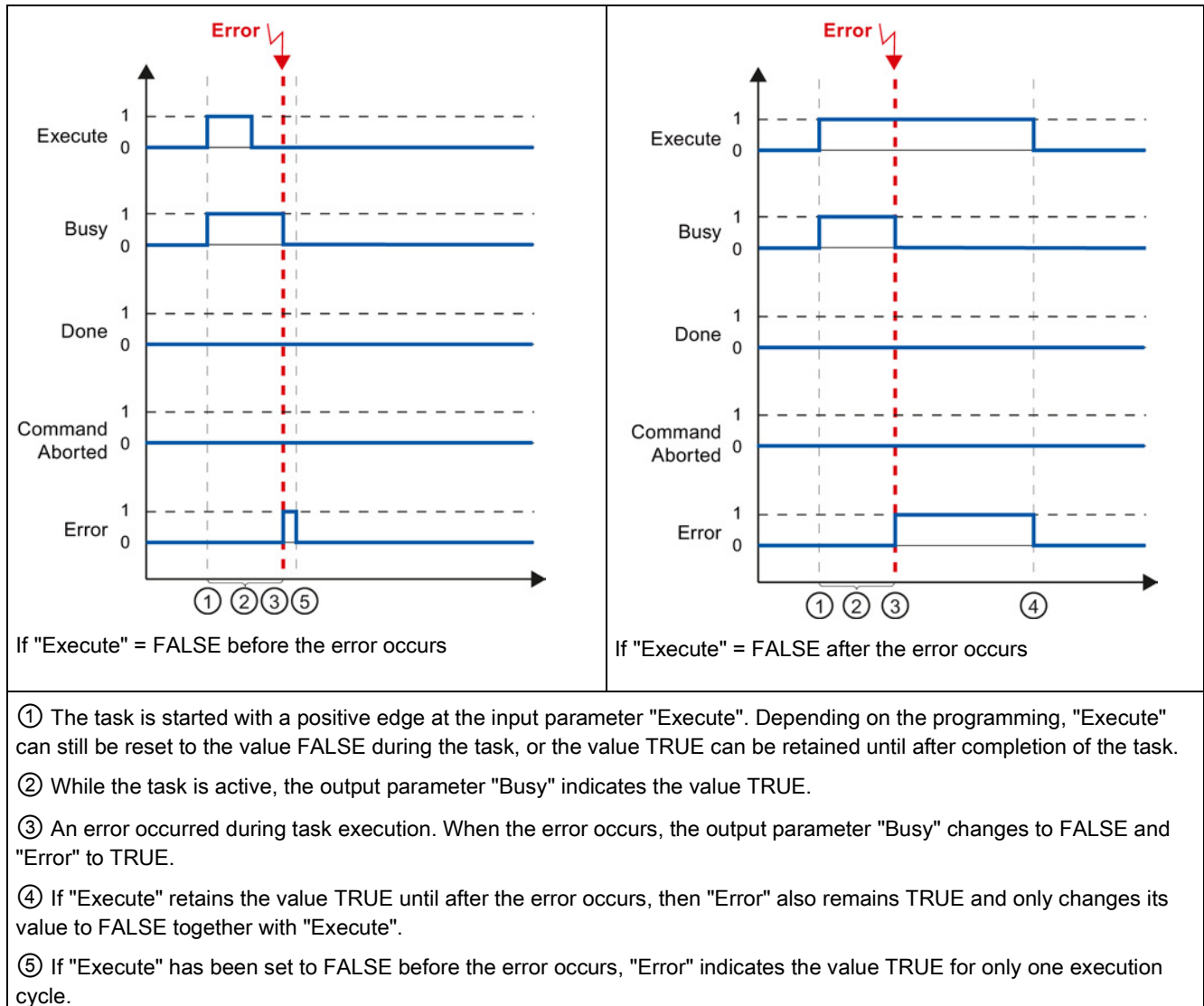

Table 9- 71 Example 3 - Error during task execution



9.3.8.2 Monitoring the MC_Velocity instruction

The tasks of the motion control instruction "MC_MoveVelocity" implement a move at the specified velocity:

- The tasks of motion control instruction "MC_MoveVelocity" do not have a defined end. The task objective is fulfilled when the parameterized velocity is reached for the first time and the axis travels at constant velocity. When the parameterized velocity is reached, this is indicated by the value TRUE in output parameter "InVelocity".
- The task is complete when the parameterized velocity has been reached and input parameter "Execute" has been set to the value FALSE. However, the axis motion is not yet complete upon completion of the task. For example, the axis motion can be stopped with motion control task "MC_Halt".
- The output parameters "Busy", "CommandAborted", and "Error" signal that the task is still being processed, has been aborted or an error is pending.
 - During execution of the motion control task, output parameter "Busy" indicates the value TRUE. If the task has been completed, aborted, or stopped by an error, the output parameter "Busy" changes its value to FALSE. This change occurs regardless of the signal at input parameter "Execute".
 - The output parameters "InVelocity", "CommandAborted", and "Error" indicate the value TRUE for at least one cycle, when their conditions are met. These status messages are latched while input parameter "Execute" is set to TRUE.

The behavior of the status bits is presented below for various example situations:

- The first example shows the behavior when the axis reaches the parameterized velocity. If the motion control task has been executed by the time the parameterized velocity is reached, this is indicated by the value TRUE in output parameter "InVelocity". The signal status of the input parameter "Execute" influences the display duration in the output parameter "InVelocity".
- The second example shows the behavior if the task is aborted before achieving the parameterized velocity. If the motion control task is aborted before the parameterized velocity is reached, this is indicated by the value TRUE in output parameter "CommandAborted". The signal status of input parameter "Execute" influences the display duration in output parameter "CommandAborted".
- The third example shows the behavior of the axis if an error occurs before achieving the parameterized velocity. If an error occurs during execution of the motion control task before the parameterized velocity has been reached, this is indicated by the value TRUE in the output parameter "Error". The signal status of the input parameter "Execute" influences the display duration in the output parameter "Error".

Table 9- 72 Example 1 - If the parameterized velocity is reached

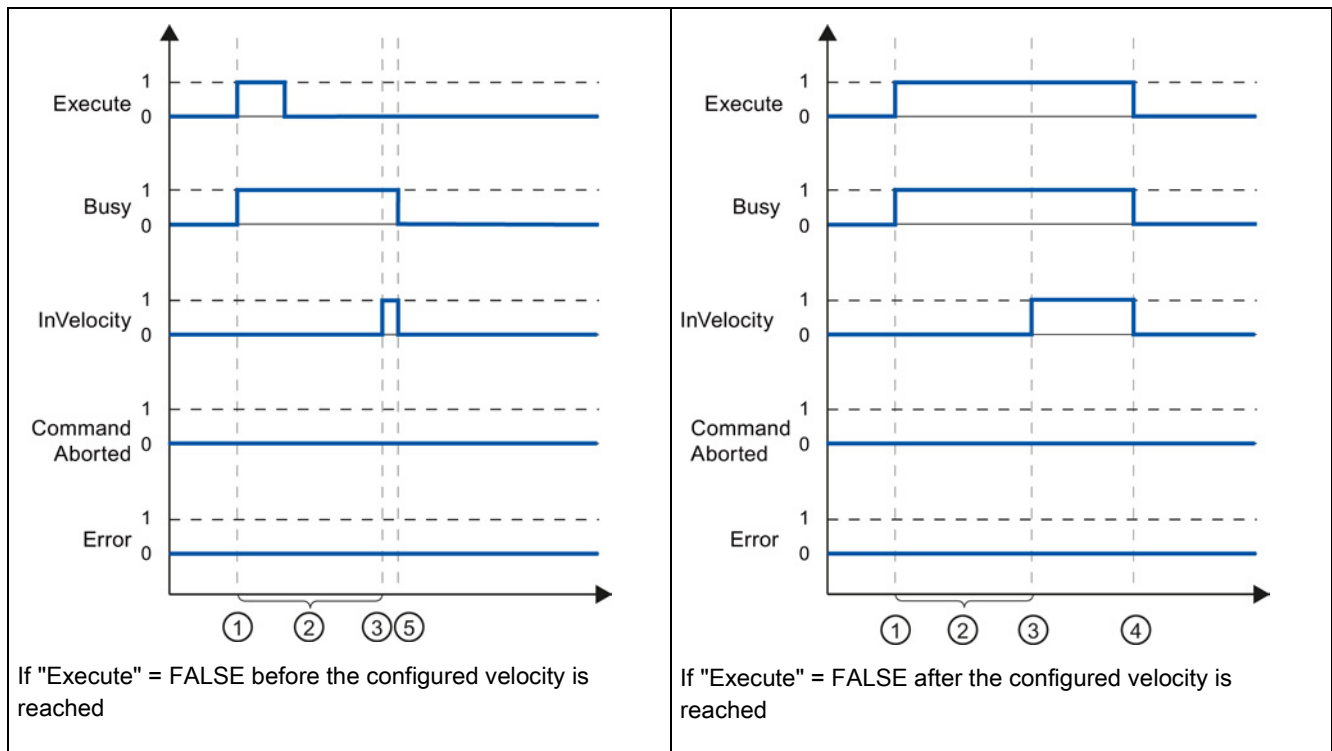

- ① The task is started with a positive edge at the input parameter "Execute". Depending on the programming, "Execute" can be reset to the value FALSE event before the parameterized velocity is reached, or alternatively only after it has been reached.
- ② While the task is active, the output parameter "Busy" indicates the value TRUE.
- ③ When the parameterized velocity is reached, the output parameter "InVelocity" changes to TRUE.
- ④ If "Execute" retains the value TRUE even after the parameterized velocity has been reached, the task remains active. "InVelocity" and "Busy" retain the value TRUE and only change their status to FALSE together with "Execute".
- ⑤ If "Execute" has been reset to FALSE before the parameterized velocity is reached, the task is complete when the parameterized velocity is reached. "InVelocity" indicates the value TRUE for one execution cycle and changes to FALSE together with "Busy".

Table 9- 73 Example 2 - If the task is aborted prior to reaching the parameterized velocity

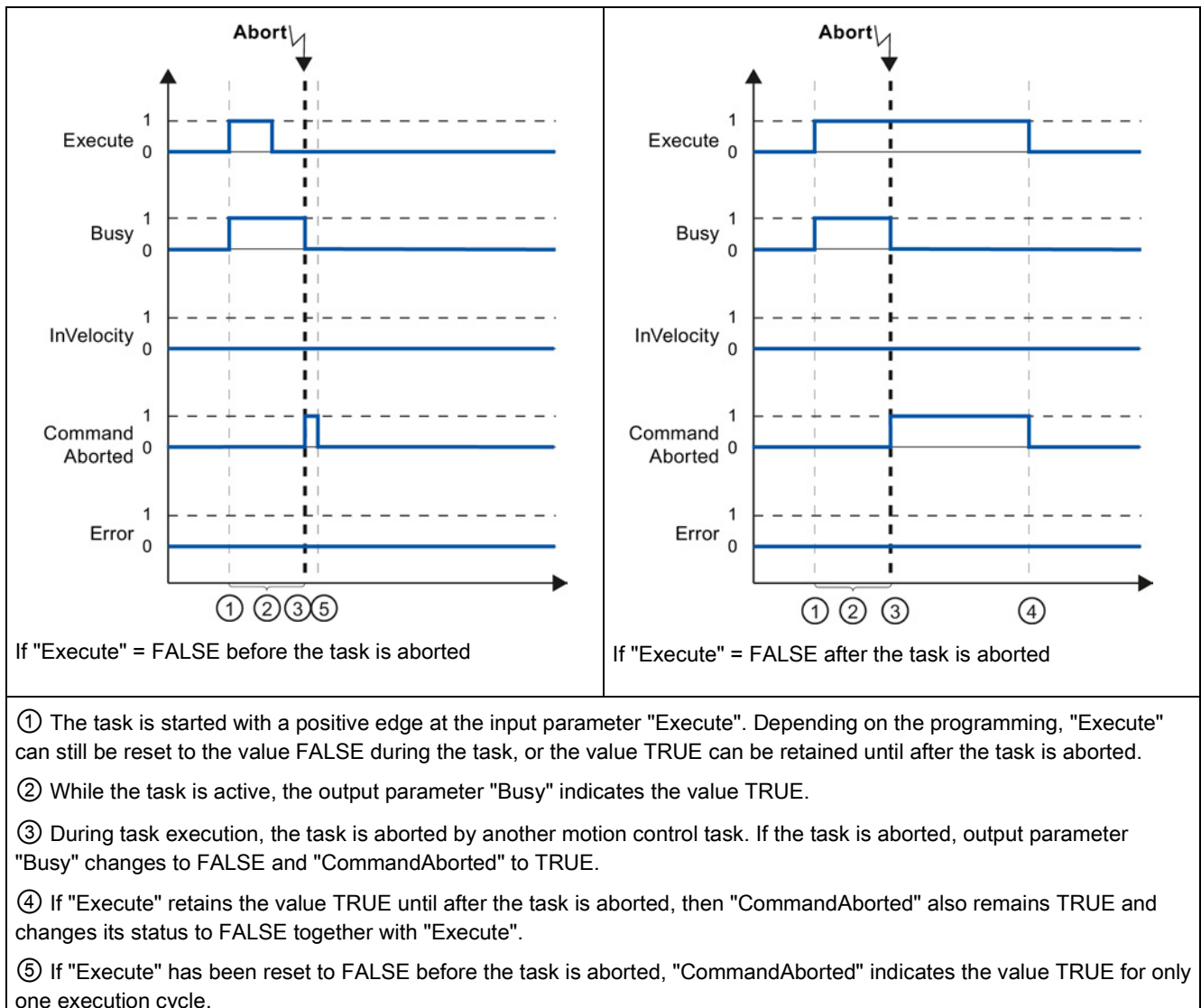
**Note**

Under the following conditions, an abort is not indicated in output parameter "CommandAborted":

- The parameterized velocity has been reached, input parameter "Execute" has the value FALSE, and a new motion control task is initiated.
- When the parameterized velocity is reached and input parameter "Execute" has the value FALSE, the task is complete. Therefore, the start of a new task is not indicated as an abort.

Table 9- 74 Example 3 - If an error occurs prior to reaching the parameterized velocity

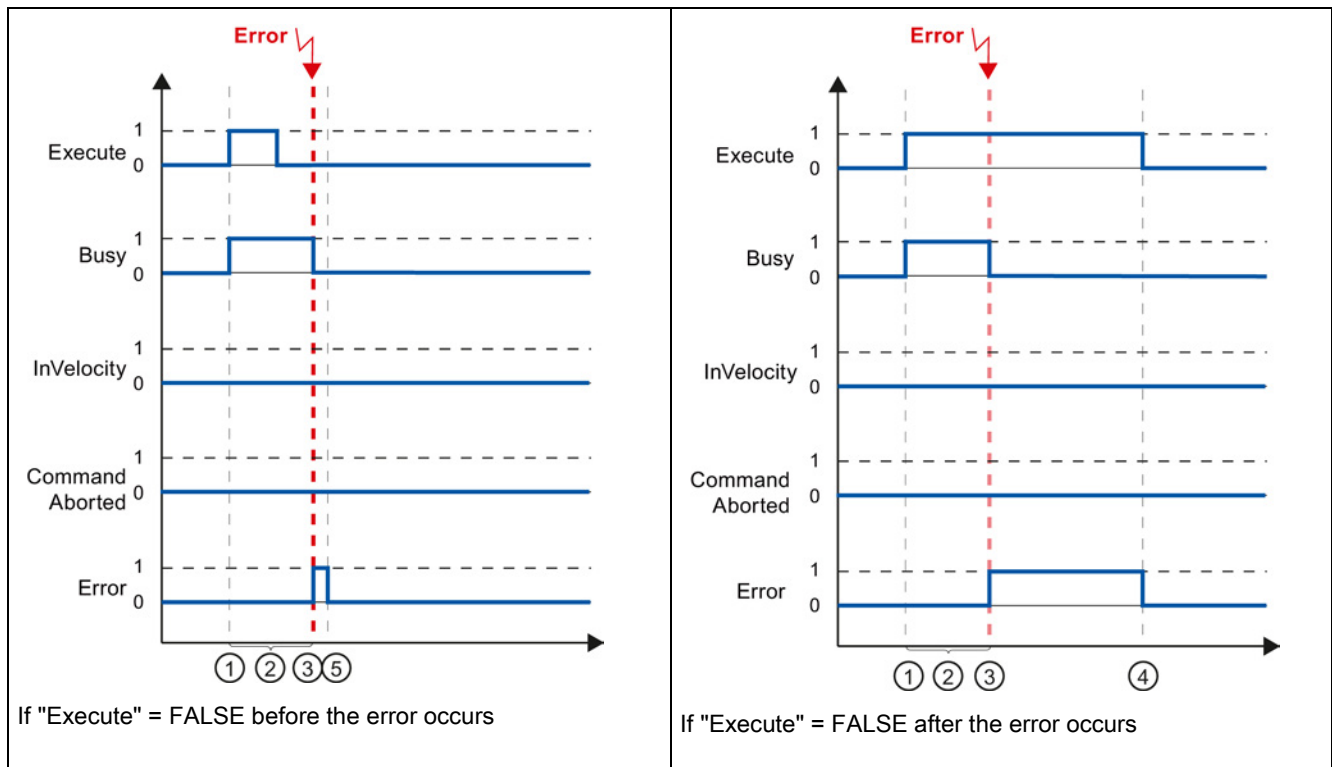

- ① The task is started with a positive edge at the input parameter "Execute". Depending on the programming, "Execute" can still be reset to the value FALSE during the task, or the value TRUE can be retained until after the error has occurred.
- ② While the task is active, the output parameter "Busy" indicates the value TRUE.
- ③ An error occurred during task execution. When the error occurs, the output parameter "Busy" changes to FALSE and "Error" to TRUE.
- ④ If "Execute" retains the value TRUE until after the error has occurred, then "Error" also remains TRUE and only changes its status to FALSE together with "Execute".
- ⑤ If "Execute" has been reset to FALSE before the error occurs, "Error" indicates the value TRUE for only one execution cycle.

Note

Under the following conditions, an error is not indicated in output parameter "Error":

- The parameterized velocity has been reached, input parameter "Execute" has the value FALSE, and an axis error occurs (software limit switch is approached, for example).
- When the parameterized velocity is reached and input parameter "Execute" has the value FALSE, the task is complete. After completion of the task, the axis error is only indicated in the motion control instruction "MC_Power".

9.3.8.3 Monitoring the MC_MoveJog instruction

The tasks of motion control instruction "MC_MoveJog" implement a jog operation.

- The motion control tasks "MC_MoveJog" do not have a defined end. The task objective is fulfilled when the parameterized velocity is reached for the first time and the axis travels at constant velocity. When the parameterized velocity is reached, this is indicated by the value TRUE in output parameter "InVelocity".
- The order is complete when input parameter "JogForward" or "JogBackward" has been set to the value FALSE and the axis has come to a standstill.
- The output parameters "Busy", "CommandAborted", and "Error" signal that the task is still being processed, has been aborted or an error is pending.
 - During processing of the motion control task, the output parameter "Busy" indicates the value TRUE. If the task has been completed, aborted, or stopped by an error, the output parameter "Busy" changes its value to FALSE.
 - The output parameter "InVelocity" indicates the status TRUE, as long as the axis is moving at the parameterized velocity. The output parameters "CommandAborted" and "Error" indicate the status for at least one cycle. These status messages are latched as long as either input parameter "JogForward" or "JogBackward" is set to TRUE.

The behavior of the status bits is presented below for various example situations.

- The first example shows the behavior of the axis if the parameterized velocity is reached and maintained. If the motion control task has been executed by the time the parameterized velocity is reached, this is indicated by the value TRUE in output parameter "InVelocity".
- The second example shows the behavior of the axis if the task is aborted. If the motion control task is aborted during execution, this is indicated by the value TRUE in output parameter "CommandAborted". The behavior is independent of whether or not the parameterized velocity has been reached.
- The third example shows the behavior of the axis if an error occurs. If an error occurs during execution of the motion control task, this is indicated by the value TRUE in output parameter "Error". The behavior is independent of whether or not the parameterized velocity has been reached.

Table 9- 75 Example 1 - If the parameterized velocity is reached and maintained

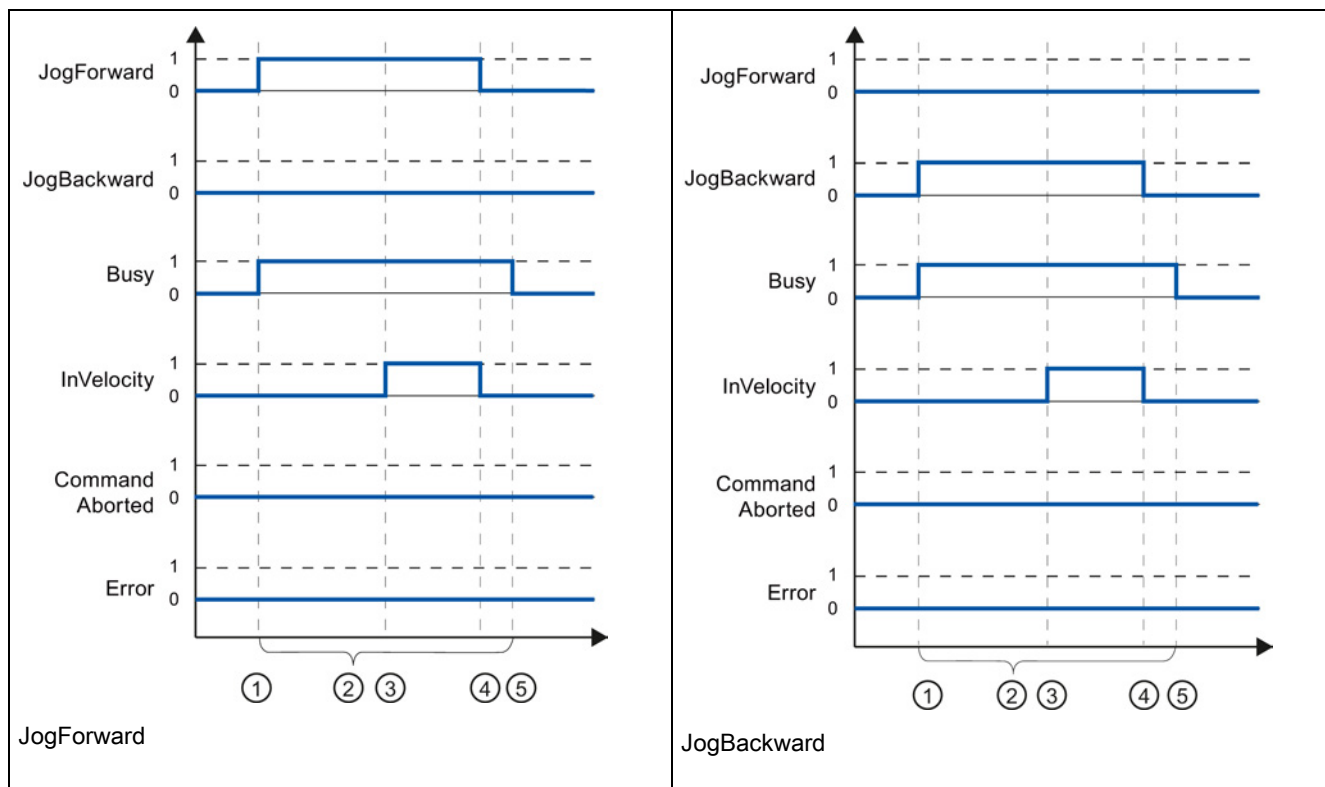

- ① The task is started with a positive edge at the input parameter "JogForward" or "JogBackward".
- ② While the task is active, the output parameter "Busy" indicates the value TRUE.
- ③ When the parameterized velocity is reached, the output parameter "InVelocity" changes to TRUE.
- ④ When the input parameter "JogForward" or "JogBackward" is reset to the value FALSE, the axis motion ends. The axis starts to decelerate. As a result, the axis no longer moves at constant velocity and the output parameter "InVelocity" changes its status to FALSE.
- ⑤ If the axis has come to a standstill, the motion control task is complete and the output parameter "Busy" changes its value to FALSE.

Table 9- 76 Example 2 - If the task is aborted during execution

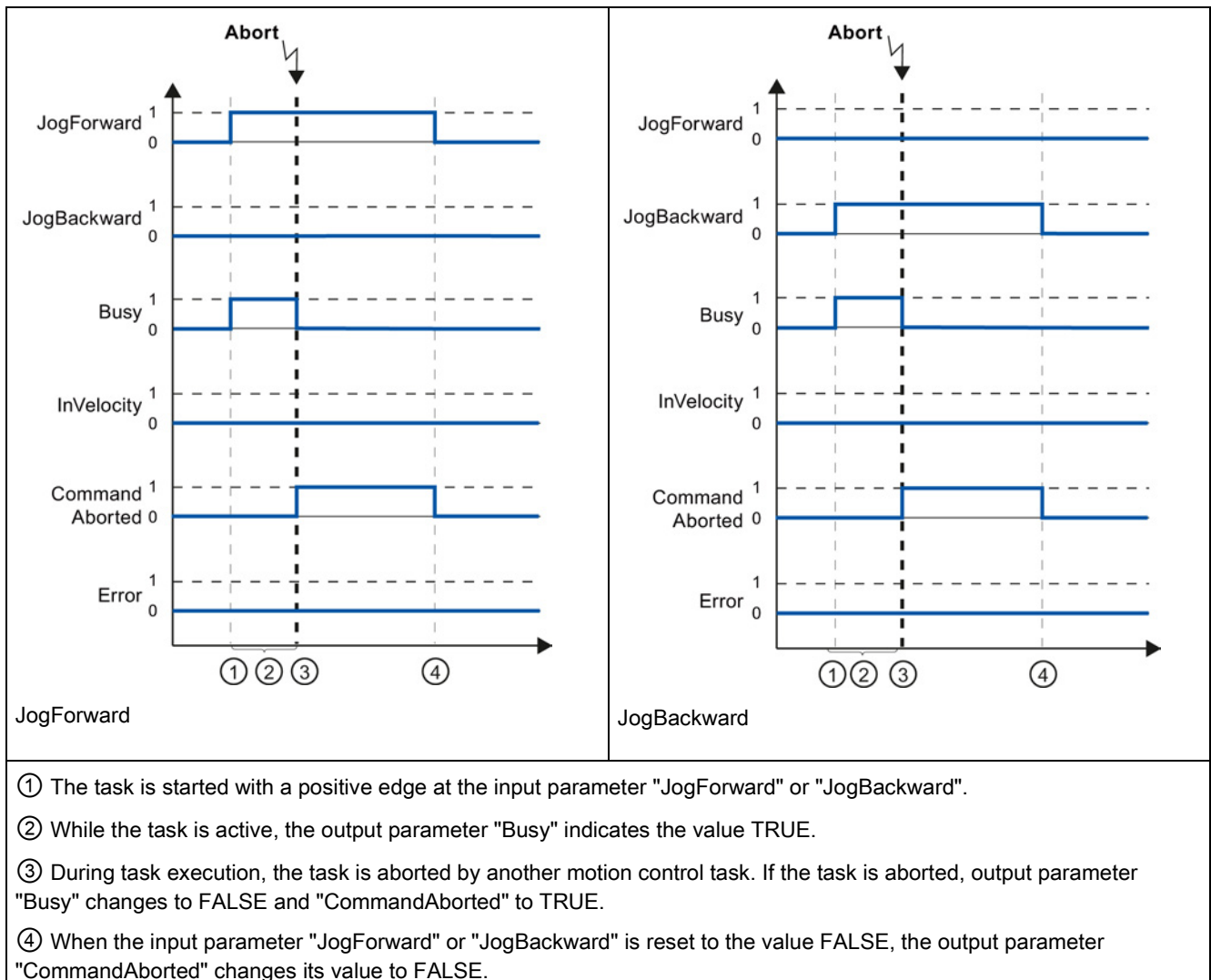
**Note**

The task abort is indicated in the output parameter "CommandAborted" for only one execution cycle, if all conditions below are met:

The input parameters "JogForward" and "JogBackward" have the value FALSE (but the axis is still decelerating) and a new motion control task is initiated.

Table 9- 77 Example 3 - If an error has occurred during task execution

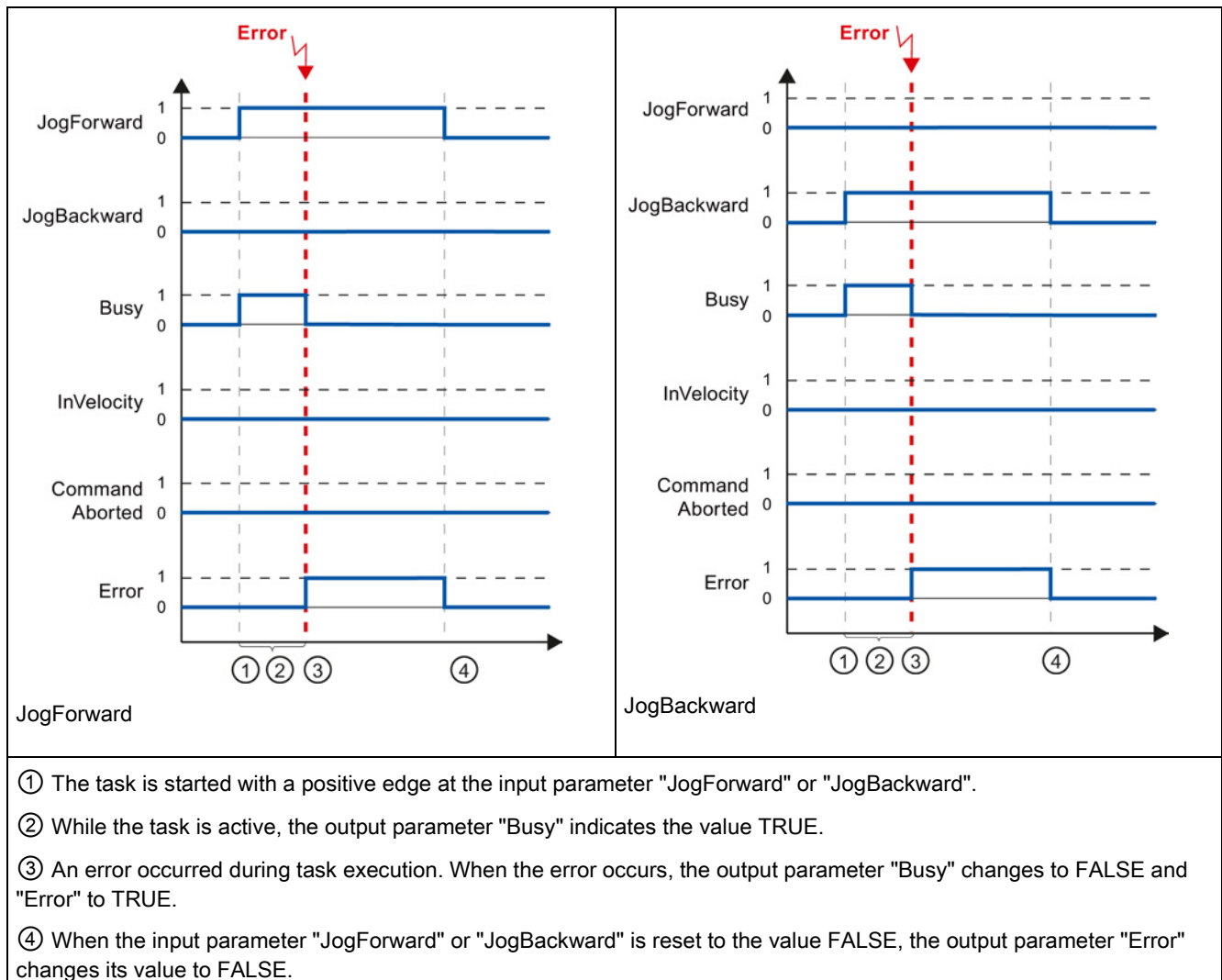

Note

An error occurrence is indicated in the output parameter "Error" for only one execution cycle, if all the conditions below are met:

The input parameters "JogForward" and "JogBackward" have the value FALSE (but the axis is still decelerating) and a new error occurs (software limit switch is approached, for example).

The S7-1200 offers several types of communication between CPUs and programming devices, HMIs, and other CPUs.

| |
|--|
|  WARNING |
| If an attacker can physically access your networks, the attacker can possibly read and write data. |
| The TIA Portal, the CPU, and HMIs (except HMIs using GET/PUT) use secure communication that protects against replay and "man-in-the-middle" attacks. Once communication is enabled, the exchange of signed messages takes place in clear text which allows an attacker to read data, but protects against unauthorized writing of data. The TIA Portal, not the communication process, encrypts the data of know-how protected blocks. |
| All other forms of communication (I/O exchange through PROFIBUS, PROFINET, AS-i, or other I/O bus, GET/PUT, T-Block, and communication modules (CM)) have no security features. You must protect these forms of communication by limiting physical access. If an attacker can physically access your networks utilizing these forms of communication, the attacker can possibly read and write data. |
| For security information and recommendations, please see our "Operational Guidelines for Industrial Security" (http://www.industry.siemens.com/topics/global/en/industrial-security/Documents/operational_guidelines_industrial_security_en.pdf) on the Siemens Service and Support site. |

PROFINET

PROFINET is used for exchanging data through the user program with other communications partners through Ethernet:

- PROFINET supports 16 IO devices with a maximum of 256 submodules. PROFIBUS allows 3 independent PROFIBUS DP Masters, supporting 32 slaves per DP master, with a maximum of 512 modules per DP master.
- S7 communication
- User Datagram Protocol (UDP) protocol
- ISO on TCP (RFC 1006)
- Transport Control Protocol (TCP)

PROFINET RT IO controller

As an IO controller using PROFINET RT, the CPU communicates with up to 16 PN devices on the local PN network or through a PN/PN coupler (link). Refer to PROFIBUS and PROFINET International, PI (www.us.profinet.com) for more information.

PROFIBUS

PROFIBUS is used for exchanging data through the user program with other communications partners through the PROFIBUS network:

- With CM 1242-5, the CPU operates as a PROFIBUS DP slave.
- With CM 1243-5, the CPU operates as a PROFIBUS DP master class1.
- PROFIBUS DP Slaves, PROFIBUS DP Masters, and AS-i (the 3 left-side communication modules) and PROFINET are separate communications networks that do not limit each other.

AS-i

The S7-1200 CM 1243-2 AS-i Master allows the attachment of an AS-i network to an S7-1200 CPU.

CPU-to-CPU S7 communication

You can create a communication connection to a partner station and use the GET and PUT instructions to communicate with S7 CPUs.

Teleservice communication

In TeleService via GPRS, an engineering station on which STEP 7 is installed communicates via the GSM network and the Internet with a SIMATIC S7-1200 station with a CP 1242-7. The connection runs via a telecontrol server that serves as an intermediary and is connected to the Internet.

IO-Link

The S7-1200 SM 1278 4xIO-Link Master enables IO-Link devices to connect to an S7 1200 CPU.

10.1 Number of asynchronous communication connections supported

The CPU supports the following maximum number of simultaneous, asynchronous communication connections for PROFINET and PROFIBUS:

- 8 connections for Open User Communications (active or passive): TSEND_C, TRCV_C, TCON, TDISCON, TSEND, and TRCV.
- 3 CPU-to-CPU S7 connections for server GET/PUT data
- 8 CPU-to-CPU S7 connections for client GET/PUT data

Note

S7-1200, S7-300, and S7-400 CPUs use the GET and PUT instructions for CPU-to-CPU S7 communication. An S7-200 CPU uses ETHx_XFER instructions for CPU-to-CPU S7 communication.

- HMI connections: You can configure the number of HMI connections required for your application through the TIA Portal.
- PG connections: The CPU provides connections to support 1 programming device (PG).
- Web server (HTTP) connections: The CPU provides connections for the Web server.

Note

The Open User Communications, S7 connection, HMI, programming device, and Web server (HTTP) communication connections may utilize multiple connection resources based upon the features currently being used.

10.2 PROFINET

10.2.1 Local/Partner connection

A Local / Partner (remote) connection defines a logical assignment of two communication partners to establish communication services. A connection defines the following:

- Communication partners involved (One active, one passive)
- Type of connection (for example, a PLC, HMI, or device connection)
- Connection path

Communication partners execute the instructions to set up and establish the communication connection. You use parameters to specify the active and passive communication end point partners. After the connection is set up and established, it is automatically maintained and monitored by the CPU. Refer to the section on "Configuring the Local/Partner connection" (Page 150) for information about configuring the parameters for the connection.

If the connection is terminated (for example, due to a line break), the active partner attempts to re-establish the configured connection. You do not have to execute the communication instruction again.

The CPU can communicate with other CPUs, with programming devices, with HMI devices, and with non-Siemens devices using standard TCP communications protocols.

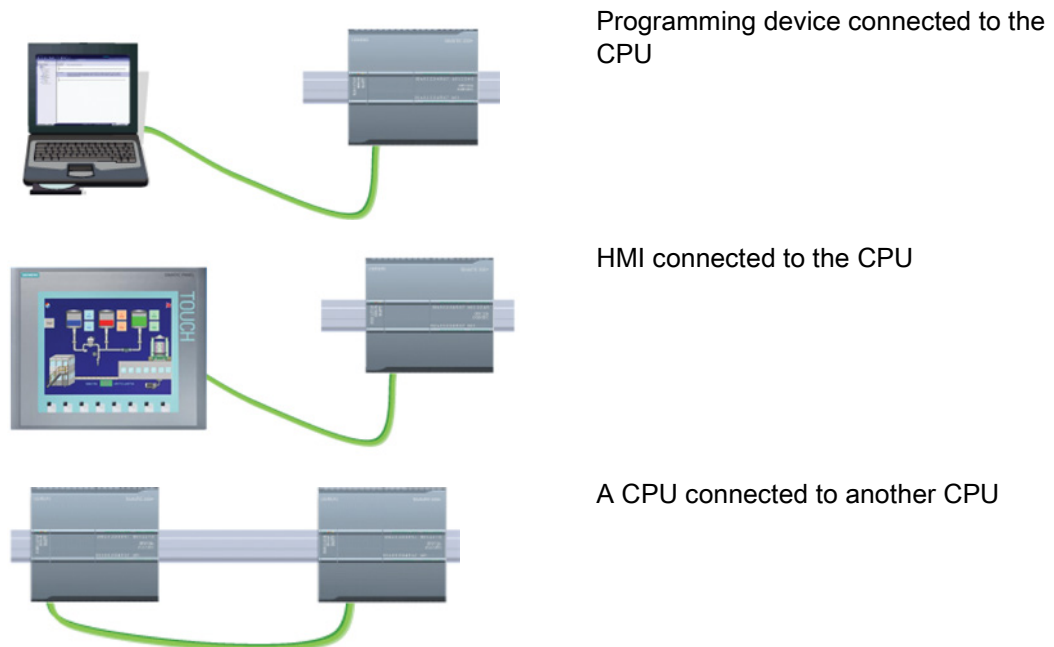

Ethernet switching

The PROFINET port on the CPU 1211C, 1212C, and 1214C does not contain an Ethernet switching device. A direct connection between a programming device or HMI and a CPU does not require an Ethernet switch. However, a network with more than two CPUs or HMI devices requires an Ethernet switch.



The CPU 1215C and the CPU 1217C have a built-in 2-port Ethernet switch. You can have a network with a CPU 1215C and two other S7-1200 CPUs. You can also use the rack-mounted CSM1277 4-port Ethernet switch for connecting multiple CPUs and HMI devices.

10.2.2 Open user communication

10.2.2.1 Connection IDs for the Open user communication instructions

When you insert the TSEND_C, TRCV_C or TCON PROFINET instructions into your user program, STEP 7 creates an instance DB to configure the communications channel (or connection) between the devices. Use the "Properties" of the instruction to configure the parameters for the connection. Among the parameters is the connection ID for that connection.

- The connection ID must be unique for the CPU. Each connection that you create must have a different DB and connection ID.
- Both the local CPU and the partner CPU can use the same connection ID number for the same connection, but the connection ID numbers are not required to match. The connection ID number is relevant only for the PROFINET instructions within the user program of the individual CPU.
- You can use any number for the connection ID of the CPU. However, configuring the connection IDs sequentially from "1" provides an easy method for tracking the number of connections in use for a specific CPU.

Note

Each TSEND_C, TRCV_C or TCON instruction in your user program creates a new connection. It is important to use the correct connection ID for each connection.

The following example shows the communication between two CPUs that utilize 2 separate connections for sending and receiving the data.

- The TSEND_C instruction in CPU_1 links to the TRCV_C in CPU_2 over the first connection ("connection ID 1" on both CPU_1 and CPU_2).
- The TRCV_C instruction in CPU_1 links to the TSEND_C in CPU_2 over the second connection ("connection ID 2" on both CPU_1 and CPU_2).

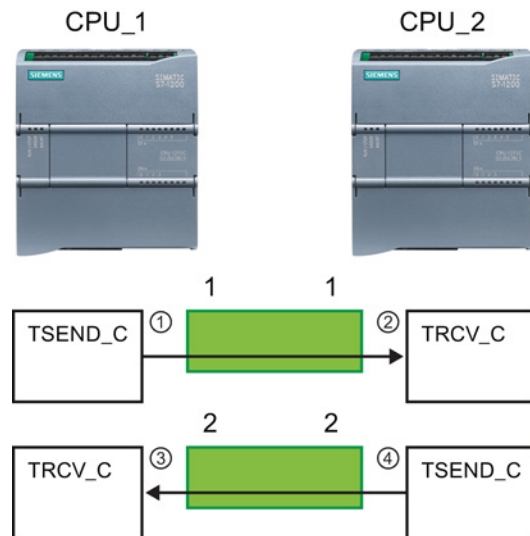

- ① TSEND_C on CPU_1 creates a connection and assigns a connection ID to that connection (connection ID 1 for CPU_1).
- ② TRCV_C on CPU_2 creates the connection for CPU_2 and assigns the connection ID (connection ID 1 for CPU_2).
- ③ TRCV_C on CPU_1 creates a second connection for CPU_1 and assigns a different connection ID for that connection (connection ID 2 for CPU_1).
- ④ TSEND_C on CPU_2 creates a second connection and assigns a different connection ID for that connection (connection ID 2 for CPU_2).

The following example shows the communication between two CPUs that utilize 1 connection for both sending and receiving the data.

- Each CPU uses a TCON instruction to configure the connection between the two CPUs.
- The TSEND instruction in CPU_1 links to the TRCV instruction in CPU_2 by using the connection ID ("connection ID 1") that was configured by the TCON instruction in CPU_1. The TRCV instruction in CPU_2 links to the TSEND instruction in CPU_1 by using the connection ID ("connection ID 1") that was configured by the TCON instruction in CPU_2.
- The TSEND instruction in CPU_2 links to the TRCV instruction in CPU_1 by using the connection ID ("connection ID 1") that was configured by the TCON instruction in CPU_2. The TRCV instruction in CPU_1 links to the TSEND instruction in CPU_1 by using the connection ID ("connection ID 1") that was configured by the TCON instruction in CPU_1.

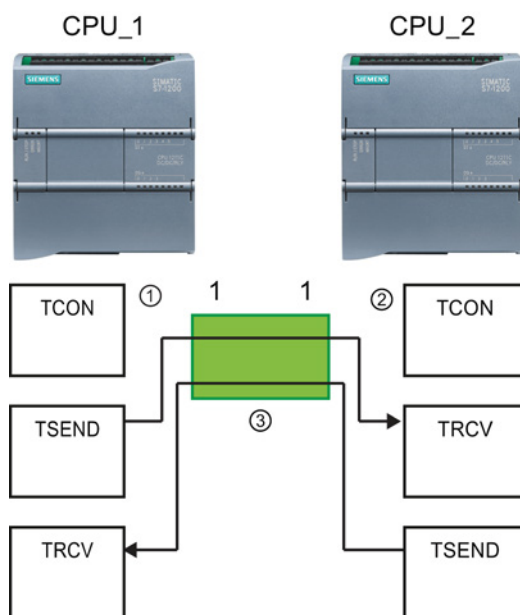

- ① TCON on CPU_1 creates a connection and assigns a connection ID for that connection on CPU_1 (ID=1).
- ② TCON on CPU_2 creates a connection and assigns a connection ID for that connection on CPU_2 (ID=1).
- ③ TSEND and TRCV on CPU_1 use the connection ID created by the TCON on CPU_1 (ID=1). TSEND and TRCV on CPU_2 use the connection ID created by the TCON on CPU_2 (ID=1).

As shown in the following example, you can also use individual TSEND and TRCV instruction to communication over a connection created by a TSEND_C or TRCV_C instruction. The TSEND and TRCV instructions do not themselves create a new connection, so must use the DB and connection ID that was created by a TSEND_C, TRCV_C or TCON instruction.

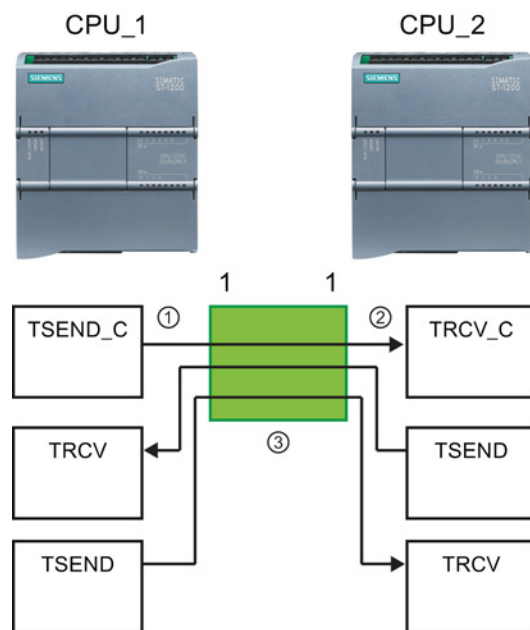

- ① TSEND_C on CPU_1 creates a connection and assigns a connection ID to that connection (ID=1).
- ② TRCV_C on CPU_2 creates a connection and assigns the connection ID to that connection on CPU_2 (ID=1).
- ③ TSEND and TRCV on CPU_1 use the connection ID created by the TSEND_C on CPU_1 (ID=1). TSEND and TRCV on CPU_2 use the connection ID created by the TRCV_C on CPU_2 (ID=1).

See also

Configuring the Local/Partner connection path (Page 150)

10.2.2.2 Protocols

The integrated PROFINET port of the CPU supports multiple communications standards over an Ethernet network:

- Transport Control Protocol (TCP)
- ISO on TCP (RFC 1006)
- User Datagram Protocol (UDP)

Table 10- 1 Protocols and communication instructions for each

| Protocol | Usage examples | Entering data in the receive area | Communication instructions | Addressing type |
|------------------|---|---|---|---|
| TCP | CPU-to-CPU communication Transport of frames | Ad hoc mode | Only TRCV_C and TRCV | Assigns port numbers to the Local (active) and Partner (passive) devices |
| | | Data reception with specified length | TSEND_C, TRCV_C, TCON, TDISCON, TSEND, and TRCV | |
| ISO on TCP | CPU-to-CPU communication Message fragmentation and re-assembly | Ad hoc mode | Only TRCV_C and TRCV | Assigns TSAPs to the Local (active) and Partner (passive) devices |
| | | Protocol-controlled | TSEND_C, TRCV_C, TCON, TDISCON, TSEND, and TRCV | |
| UDP | CPU-to-CPU communication User program communications | User Datagram Protocol | TUSEND and TURCV | Assigns port numbers to the Local (active) and Partner (passive) devices, but is not a dedicated connection |
| S7 communication | CPU-to-CPU communication Read/write data from/to a CPU | Data transmission and reception with specified length | GET and PUT | Assigns TSAPs to the Local (active) and Partner (passive) devices |
| PROFINET RT | CPU-to-PROFINET IO device communication | Data transmission and reception with specified length | Built-in | Built-in |

10.2.2.3 Ad hoc mode

Typically, TCP and ISO-on-TCP receive data packets of a specified length, ranging from 1 to 8192 bytes. However, the TRCV_C and TRCV communication instructions also provide an "ad hoc" communications mode that can receive data packets of a variable length from 1 to 1472 bytes.

Note

If you store the data in an "optimized" DB (symbolic only), you can receive data only in arrays of Byte, Char, USInt, and SInt data types.

To configure the TRCV_C or TRCV instruction for ad hoc mode, set the ADHOC instruction input parameter.

If you do not call the TRCV_C or TRCV instruction in ad hoc mode frequently, you could receive more than one packet in one call. For example: If you were to receive five 100-byte packets with one call, TCP would deliver these five packets as one 500-byte packet, while ISO-on-TCP would restructure the packets into five 100-byte packets.

10.2.2.4 TCP and ISO on TCP

Transport Control Protocol (TCP) is a standard protocol described by RFC 793: Transmission Control Protocol. The primary purpose of TCP is to provide reliable, secure connection service between pairs of processes. This protocol has the following features:

- An efficient communications protocol since it is closely tied to the hardware
- Suitable for medium-sized to large data amounts (up to 8192 bytes)
- Provides considerably more facilities for applications, notably error recovery, flow control, and reliability
- A connection-oriented protocol
- Can be used very flexibly with third-party systems which exclusively support TCP
- Routing-capable
- Only static data lengths are applicable.
- Messages are acknowledged.
- Applications are addressed using port numbers.
- Most of the user application protocols, such as TELNET and FTP, use TCP.
- Programming effort is required for data management due to the SEND / RECEIVE programming interface.

International Standards Organization (ISO) on Transport Control Protocol (TCP) (RFC 1006) (ISO on TCP) is a mechanism that enables ISO applications to be ported to the TCP/IP network. This protocol has the following features:

- An efficient communications protocol closely tied to the hardware
- Suitable for medium-sized to large data amounts (up to 8192 bytes)
- In contrast to TCP, the messages feature an end-of-data identification and are message-oriented.
- Routing-capable; can be used in WAN
- Dynamic data lengths are possible.
- Programming effort is required for data management due to the SEND / RECEIVE programming interface.

Using Transport Service Access Points (TSAPs), TCP protocol allows multiple connections to a single IP address (up to 64K connections). With RFC 1006, TSAPs uniquely identify these communication end point connections to an IP address.

10.2.2.5 TSEND_C and TRCV_C (Send and receive data via Ethernet) instructions

The TSEND_C instruction combines the functions of the TCON, TDISCON and TSEND instructions. The TRCV_C instruction combines the functions of the TCON, TDISCON, and TRCV instructions. (Refer to "TCON, TDISCON, TSEND, and TRCV (TCP communication) instructions (Page 527)" for more information on these instructions.)

The minimum size of data that you can transmit (TSEND_C) or receive (TRCV_C) is one byte; the maximum size is 8192 bytes. TSEND_C does not support the transmission of data from Boolean locations, and TRCV_C will not receive data into Boolean locations. For information on transferring data with these instructions, see the section on data consistency (Page 178).

Note

Initializing the communication parameters

After you insert the TSEND_C or TRCV_C instruction, use the "Properties" of the instruction (Page 150) to configure the communication parameters (Page 153). As you enter the parameters for the communication partners in the inspector window, STEP 7 enters the corresponding data in the DB for the instruction.

If you want to use a multi-instance DB, you must manually configure the DB on both CPUs.

Table 10-2 TSEND_C and TRCV_C instructions

| LAD / FBD | SCL | Description |
|-----------|--|--|
| | <pre>"TSEND_C_DB" (req:=_bool_in_, cont:=_bool_in_, len:=_uint_in_, done=>_bool_out_, busy=>_bool_out_, error=>_bool_out_, status=>_word_out_, connect:=_struct_inout_, data:=_variant_inout_, com rst:=_bool_inout_);</pre> | <p>TSEND_C establishes a TCP or ISO on TCP communication connection to a partner station, sends data, and can terminate the connection. After the connection is set up and established, it is automatically maintained and monitored by the CPU.</p> |
| | <pre>"TRCV_C_DB" (en_r:=_bool_in_, cont:=_bool_in_, len:=_uint_in_, adhoc:=_bool_in_, done=>_bool_out_, busy=>_bool_out_, error=>_bool_out_, status=>_word_out_, rcvd_len=>_uint_out_, connect:=_struct_inout_, data:=_variant_inout_, com rst:=_bool_inout_);</pre> | <p>TRCV_C establishes a TCP or ISO on TCP communication connection to a partner CPU, receives data, and can terminate the connection. After the connection is set up and established, it is automatically maintained and monitored by the CPU.</p> |

¹ STEP 7 automatically creates the DB when you insert the instruction.

Table 10-3 TSEND_C and TRCV_C data types for the parameters

| Parameter and type | Data type | Description | |
|--------------------|-----------|-------------|---|
| REQ (TSEND_C) | IN | Bool | Control parameter REQ starts the send job with the connection described in CONNECT on a rising edge. |
| EN_R (TRCV_C) | IN | Bool | Control parameter enabled to receive: When EN_R = 1, TRCV_C is ready to receive. The receive job is processed. |
| CONT | IN | Bool | <ul style="list-style-type: none"> 0: Disconnect 1: Establish and hold connection |
| LEN | IN | UInt | <p>Maximum number of bytes to be sent (TSEND_C) or received (TRCV_C):</p> <ul style="list-style-type: none"> Default = 0: The DATA parameter determines the length of the data to be sent (TSEND_C) or received (TRCV_C). Ad hoc mode = 65535: A variable length of data is set for reception (TRCV_C). |
| CONNECT | IN_OUT | TCON_Param | Pointer to the connection description (Page 153) |

| Parameter and type | | Data type | Description |
|----------------------|--------|-----------|---|
| DATA | IN_OUT | Variant | <ul style="list-style-type: none"> Contains address and length of data to be sent (TSEND_C) Contains start address and maximum length of received data (TRCV_C). |
| COM_RST | IN_OUT | Bool | Allows restart of the instruction: <ul style="list-style-type: none"> 0: Irrelevant 1: Complete restart of the function block, existing connection will be terminated. |
| DONE | OUT | Bool | <ul style="list-style-type: none"> 0: Job is not yet started or still running. 1: Job completed without error. |
| BUSY | OUT | Bool | <ul style="list-style-type: none"> 0: Job is completed. 1: Job is not yet completed. A new job cannot be triggered. |
| ERROR | OUT | Bool | Status parameters with the following values: <ul style="list-style-type: none"> 0: No error 1: Error occurred during processing. STATUS provides detailed information on the type of error. |
| STATUS | OUT | Word | Status information including error information. (Refer to the "Error and Status Parameters" table below.) |
| RCVD_LEN (TRCV_C) | OUT | Int | Amount of data actually received, in bytes |

Note

The TSEND_C instruction requires a low-to-high transition at the REQ input parameter to start a send job. The BUSY parameter is then set to 1 during processing. Completion of the send job is indicated by either the DONE or ERROR parameters being set to 1 for one scan. During this time, any low-to-high transition at the REQ input parameter is ignored.

Note

The default setting of the LEN parameter (LEN = 0) uses the DATA parameter to determine the length of the data being transmitted. Ensure that the DATA transmitted by the TSEND_C instruction is the same size as the DATA parameter of the TRCV_C instruction.

TSEND_C operations

The following functions describe the operation of the TSEND_C instruction:

- To establish a connection, execute TSEND_C with CONT = 1.
- After successful establishing of the connection, TSEND_C sets the DONE parameter for one cycle.
- To terminate the communication connection, execute TSEND_C with CONT = 0. The connection will be aborted immediately. This also affects the receiving station. The connection will be closed there and data inside the receive buffer could be lost.
- To send data over an established connection, execute TSEND_C with a rising edge on REQ. After a successful send operation, TSEND_C sets the DONE parameter for one cycle.
- To establish a connection and send data, execute TSEND_C with CONT =1 and REQ = 1. After a successful send operation, TSEND_C sets the DONE parameter for one cycle.

TRCV_C operations

The following functions describe the operation of the TRCV_C instruction:

- To establish a connection, execute TRCV_C with parameter CONT = 1.
- To receive data, execute TRCV_C with parameter EN_R = 1. TRCV_C receives the data continuously when parameters EN_R = 1 and CONT = 1.
- To terminate the connection, execute TRCV_C with parameter CONT = 0. The connection will be aborted immediately, and data could be lost.

TRCV_C handles the same receive modes as the TRCV instruction. The following table shows how data is entered in the receive area:

Table 10-4 Entering the data into the receive area

| Protocol variant | Entering the data in the receive area | Parameter "connection_type" | Value of the LEN parameter | Value of the RCVD_LEN parameter (bytes) |
|------------------|---------------------------------------|-----------------------------|--|---|
| TCP | Ad hoc mode | B#16#11 | 65535 | 1 to 1472 |
| TCP | Data reception with specified length | B#16#11 | 0 (recommended) or 1 to 8192, except 65535 | 1 to 8192 |
| ISO on TCP | Ad hoc mode | B#16#12 | 65535 | 1 to 1472 |
| ISO on TCP | Protocol-controlled | B#16#12 | 0 (recommended) or 1 to 8192, except 65535 | 1 to 8192 |

Note

Ad hoc mode

The "ad hoc mode" exists with the TCP and ISO on TCP protocol variants. You set "ad hoc mode" by assigning "65535" to the LEN parameter. The receive area is identical to the area formed by DATA. The length of the received data will be output to the parameter RCVD_LEN.

If you store the data in an "optimized" DB (symbolic only), you can receive data only in arrays of Byte, Char, USInt, and SInt data types.

Note

Importing of S7-300/400 STEP 7 projects containing "ad hoc mode" into the S7-1200

In S7-300/400 STEP 7 projects, "ad hoc mode" is selected by assigning "0" to the LEN parameter. In the S7-1200, you set "ad hoc mode" by assigning "65535" to the LEN parameter.

If you import an S7-300/400 STEP 7 project containing "ad hoc mode" into the S7-1200, you must change the LEN parameter to "65535".

Note

Must keep the data in the sender area consistent until the DONE parameter or the ERROR parameter assumes the value TRUE

Due to the asynchronous processing of TSEND_C, you must keep the data in the sender area consistent until the DONE parameter or the ERROR parameter assumes the value TRUE.

For TSEND_C, a TRUE state at the parameter DONE means that the data was sent successfully. It does not mean that the connection partner CPU actually read the receive buffer.

Due to the asynchronous processing of TRCV_C, the data in the receiver area are only consistent when parameter DONE = 1.

Table 10- 5 TSEND_C and TRCV_C instructions BUSY, DONE, and ERROR parameters

| BUSY | DONE | ERROR | Description |
|-------|------------|------------|---|
| TRUE | irrelevant | irrelevant | The job is being processed. |
| FALSE | TRUE | FALSE | The job is successfully completed. |
| FALSE | FALSE | TRUE | The job was ended with an error. The cause of the error can be found in the STATUS parameter. |
| FALSE | FALSE | FALSE | A new job was not assigned. |

TSEND_C and TRCV_C Error and Status condition codes

| ERROR | STATUS | Description |
|-------|--------|---|
| 0 | 0000 | Job executed without error |
| 0 | 7000 | No job processing active |
| 0 | 7001 | Start job processing, establishing connection, waiting for connection partner |
| 0 | 7002 | Data being sent or received |
| 0 | 7003 | Connection being terminated |
| 0 | 7004 | Connection established and monitored, no job processing active |
| 1 | 8085 | LEN parameter is greater than the largest permitted value. |
| 1 | 8086 | The CONNECT parameter is outside the permitted range. |
| 1 | 8087 | Maximum number of connections reached; no additional connection possible. |
| 1 | 8088 | LEN parameter is not valid for the memory area specified in DATA. |
| 1 | 8089 | The CONNECT parameter does not point to a data block. |
| 1 | 8091 | Maximum nesting depth exceeded. |
| 1 | 809A | The CONNECT parameter points to a field that does not match the length of the connection description. |
| 1 | 809B | The local_device_id in the connection description does not match the CPU. |
| 1 | 80A1 | Communications error: <ul style="list-style-type: none"> • The specified connection was not yet established • The specified connection is currently being terminated; transmission over this connection is not possible • The interface is being reinitialized |
| 1 | 80A3 | Attempt being made to terminate a nonexistent connection |
| 1 | 80A4 | IP address of the remote partner connection is invalid. For example, the remote partner IP address is the same as the local partner IP address. |
| 1 | 80A5 | Connection ID (Page 514) is already in use. |
| 1 | 80A7 | Communications error: You called TDISCON before TSEND_C was complete. |
| 1 | 80B2 | The CONNECT parameter points to a data block that was generated with the keyword UNLINKED. |
| 1 | 80B3 | Inconsistent parameters: <ul style="list-style-type: none"> • Error in the connection description • Local port (parameter local_tsap_id) is already present in another connection description. • ID in the connection description different from the ID specified as parameter |

| ERROR | STATUS | Description |
|-------|--------|---|
| 1 | 80B4 | <p>When using the ISO on TCP (connection_type = B#16#12) to establish a passive connection, condition code 80B4 alerts you that the TSAP entered did not conform to one of the following address requirements:</p> <ul style="list-style-type: none"> • For a local TSAP length of 2 and a TSAP ID value of either E0 or E1 (hexadecimal) for the first byte, the second byte must be either 00 or 01. • For a local TSAP length of 3 or greater and a TSAP ID value of either E0 or E1 (hexadecimal) for the first byte, the second byte must be either 00 or 01 and all other bytes must be valid ASCII characters. • For a local TSAP length of 3 or greater and the first byte of the TSAP ID does not have a value of either E0 or E1 (hexadecimal), then all bytes of the TSAP ID must be valid ASCII characters. <p>Valid ASCII characters are byte values from 20 to 7E (hexadecimal).</p> |
| 1 | 80B7 | Data type and/or length of the transmitted data does not fit in the area in the partner CPU in which it is to be written. |
| 1 | 80C3 | All connection resources are in use. |
| 1 | 80C4 | <p>Temporary communications error:</p> <ul style="list-style-type: none"> • The connection cannot be established at this time • The interface is receiving new parameters • The configured connection is currently being removed by a TDISCON. |
| 1 | 8722 | CONNECT parameter: Source area invalid: area does not exist in DB. |
| 1 | 873A | CONNECT parameter: Access to connection description is not possible (for example, DB not available) |
| 1 | 877F | CONNECT parameter: Internal error such as an invalid ANY reference |
| 1 | 893A | Parameter contains the number of a DB that is not loaded. |

Connection Ethernet protocols

Every CPU has an integrated PROFINET port, which supports standard PROFINET communications. The TSEND_C and TRCV_C and TSEND and TRCV instructions all support the TCP and ISO on TCP Ethernet protocols.

Refer to "Device Configuration: Configuring the Local/Partner connection path (Page 150)" for more information.

10.2.2.6 TCON, TDISCON, TSEND, and TRCV (TCP communication) instructions

Ethernet communication using TCP and ISO on TCP protocols

Note

TSEND_C and TRCV_C instructions

To help simplify the programming of PROFINET/Ethernet communication, the TSEND_C instruction and the TRCV_C instruction combine the functionality of the TCON, TDISCON, TSEND and TRCV instructions:

- TSEND_C combines the TCON, TDISCON and TSEND instructions.
- TRCV_C combines the TCON, TDISCON and TRCV instructions.

The following instructions control the communication process:

- TCON establishes the TCP/IP connection between the client and server (CPU) PC.
- TSEND and TRCV send and receive data.
- TDISCON breaks the connection.

The minimum size of data that you can transmit (TSEND) or receive (TRCV) is one byte; the maximum size is 8192 bytes. TSEND does not support the transmission of data from Boolean locations, and TRCV will not receive data into Boolean locations. For information transferring data with these instructions, see the section on data consistency (Page 178).

TCON, TDISCON, TSEND, and TRCV operate asynchronously, which means that the job processing extends over multiple instruction executions. For example, you start a job for setting up and establishing a connection by executing an instruction TCON with parameter REQ = 1. Then you use additional TCON executions to monitor the job progress and test for job completion with parameter DONE.

The following table shows the relationships between BUSY, DONE, and ERROR. Use the table to determine the current job status:

Table 10- 6 Interactions between the BUSY, DONE, and ERROR parameters

| BUSY | DONE | ERROR | Description |
|-------|------------|------------|---|
| TRUE | irrelevant | irrelevant | The job is being processed. |
| FALSE | TRUE | FALSE | The job successfully completed. |
| FALSE | FALSE | TRUE | The job was ended with an error. The cause of the error can be found in the STATUS parameter. |
| FALSE | FALSE | FALSE | A new job was not assigned. |

TCON and TDISCON

Note

Initializing the communication parameters

After you insert the TCON instruction, use the "Properties" of the instruction (Page 150) to configure the communication parameters (Page 153). As you enter the parameters for the communication partners in the inspector window, STEP 7 enters the corresponding data in the instance DB for the instruction.

If you want to use a multi-instance DB, you must manually configure the DB on both CPUs.

Table 10- 7 TCON and TDISCON instructions

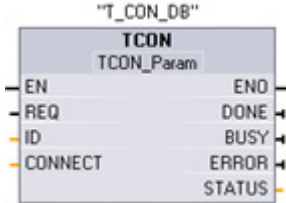
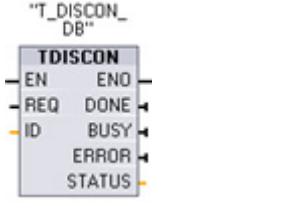
| LAD / FBD | | Description |
|---|---|---|
|  | <pre>"TCON_DB" (req:=_bool_in_, ID:=_undef_in_, done=>_bool_out_, busy=>_bool_out_, error=>_bool_out_, status=>_word_out_, connect:= struct inout);</pre> | TCP and ISO on TCP: TCON initiates a communications connection from the CPU to a communication partner. |
|  | <pre>"TDISCON_DB" (req:=_bool_in_, ID:=_word_in_, done=>_bool_out_, busy=>_bool_out_, error=>_bool_out_, status=>_word_out_);</pre> | TCP and ISO on TCP: TDISCON terminates a communications connection from the CPU to a communication partner. |

¹ STEP 7 automatically creates the DB when you insert the instruction.

Table 10- 8 Data types for the parameters of TCON and TDISCON

| Parameter and type | Data type | Description |
|--------------------|-----------|---|
| REQ | IN | Bool |
| ID | IN | CONN_OUC (Word) |
| CONNECT (TCON) | IN_OUT | TCON_Param |
| | | Control parameter REQ starts the job by establishing the connection specified by ID. The job starts at rising edge. |
| | | Reference to the connection to be established (TCON) or terminated (TDISCON) to the remote partner, or between the user program and the communication layer of the operating system. The ID must be identical to the associated parameter ID in the local connection description. Value range: W#16#0001 to W#16#0FFF |
| | | Pointer to the connection description (Page 153) |

| Parameter and type | | Data type | Description |
|--------------------|-----|-----------|---|
| DONE | OUT | Bool | <ul style="list-style-type: none"> 0: Job is not yet started or still running. 1: Job completed without error. |
| BUSY | OUT | Bool | <ul style="list-style-type: none"> 0: Job is completed. 1: Job is not yet completed. A new job cannot be triggered. |
| ERROR | OUT | Bool | Status parameters with the following values: <ul style="list-style-type: none"> 0: No error 1: Error occurred during processing. STATUS provides detailed information on the type of error. |
| STATUS | OUT | Word | Status information including error information. (Refer to the Error and Status condition codes in the table below.) |

Both communication partners execute the TCON instruction to set up and establish the communication connection. You use parameters to specify the active and passive communication end point partners. After the connection is set up and established, it is automatically maintained and monitored by the CPU.

If the connection is terminated due to a line break or due to the remote communications partner, for example, the active partner attempts to re-establish the configured connection. You do not have to execute TCON again.

An existing connection is terminated and the set-up connection is removed when the TDISCON instruction is executed or when the CPU has gone into STOP mode. To set up and re-establish the connection, you must execute TCON again.

Table 10-9 ERROR and STATUS condition codes for TCON and TDISCON

| ERROR | STATUS | Description |
|----------|--------|---|
| 0 | 0000 | Connection was established successfully. |
| 0 | 7000 | No job processing active |
| 0 | 7001 | Start job processing; establishing connection (TCON) or terminating connection (TDISCON) |
| 0 | 7002 | Follow-on call (REQ irrelevant); establishing connection (TCON) or terminating connection (TDISCON) |
| 1 | 8086 | The ID parameter is outside the permitted address range. |
| 1 | 8087 | TCON: Maximum number of connections reached; no additional connection possible. |
| 1 | 809B | TCON: The local_device_id in the connection description does not match the CPU. |
| 1 | 80A1 | TCON: Connection or port is already occupied by user. |
| 1 | 80A2 | TCON: Local or remote port is occupied by the system. |
| 1 | 80A3 | Attempt being made to re-establish an existing connection (TCON) or terminate a non-existent connection (TDISCON). |
| 1 | 80A4 | TCON: IP address of the remote connection end point is invalid; it may match the local IP address. |
| 1 | 80A5 | TCON: Connection ID (Page 514) is already in use. |
| 1 () | 80A7 | TCON: Communications error: you executed TDISCON before TCON was complete. TDISCON must first completely terminate the connection referenced by the ID. |



| ERROR | STATUS | Description |
|-------|--------|---|
| 1 | 80B4 | <p>TCON: When using the ISO on TCP (connection_type = B#16#12) to establish a passive connection, condition code 80B4 alerts you that the TSAP entered did not conform to one of the following address requirements:</p> <ul style="list-style-type: none"> • For a local TSAP length of 2 and a TSAP ID value of either E0 or E1 (hexadecimal) for the first byte, the second byte must be either 00 or 01. • For a local TSAP length of 3 or greater and a TSAP ID value of either E0 or E1 (hexadecimal) for the first byte, the second byte must be either 00 or 01 and all other bytes must be valid ASCII characters. • For a local TSAP length of 3 or greater and the first byte of the TSAP ID does not have a value of either E0 or E1 (hexadecimal), then all bytes of the TSAP ID must be valid ASCII characters. <p>Valid ASCII characters are byte values from 20 to 7E (hexadecimal).</p> |
| 1 | 80B6 | TCON: Parameter assignment error in parameter connection_type |
| 1 | 80B7 | TCON: Data type and/or length of the transmitted data does not fit in the area in the partner CPU, in which it is to be written. |
| 1) | 80B8 | TCON: Parameter in the local connection description and Parameter ID are different. |
| 1 | 80C3 | TCON: All connection resources are in use. |
| 1 | 80C4 | <p>Temporary communications error:</p> <ul style="list-style-type: none"> • The connection cannot be established at this time (TCON). • The configured connection is currently being removed by TDISCON (TCON). • The connection is currently being established (TDISCON). • The interface is receiving new parameters (TCON and TDISCON). |

TSEND and TRCV

Note

When using PROFINET Open User communication, if you execute a TSEND instruction without a corresponding TRCV instruction executing on the remote device, then the TSEND instruction may reside indefinitely in a "Busy State", waiting for the TRCV instruction to receive the data. In this state, the TSEND instruction "Busy" output is set, and the "Status" output has a value of "0x7002". This condition may occur if you are transferring more than 4096 bytes of data. The issue is resolved at the next execution of the TRCV instruction.

Table 10- 10 TSEND and TRCV instructions

| LAD / FBD | SCL | Description |
|---|---|---|
|  | <pre>"TSEND_DB" (req:=_bool_in_, ID:=_word_in_, len:=_udint_in_, done=>_bool_out_, busy=>_bool_out_, error=>_bool_out_, status=>_word_out_, data:=_variant_inout_);</pre> | <p>TCP and ISO on TCP: TSEND sends data through a communication connection from the CPU to a partner station.</p> |
|  | <pre>"TRCV_DB" (en_r:=_bool_in_, ID:=_word_in_, len:=_udint_in_, ndr=>_bool_out_, busy=>_bool_out_, error=>_bool_out_, status=>_word_out_, rcvd_len=>_udint_out_, data:=_variant_inout_);</pre> | <p>TCP and ISO on TCP: TRCV receives data through a communication connection from a partner station to the CPU.</p> |

¹ STEP 7 automatically creates the DB when you insert the instruction.

Table 10- 11 Data types for the parameters of TSEND and TRCV

| Parameter and type | Data type | Description |
|--------------------|-----------------|--|
| REQ IN | Bool | TSEND: Starts the send job on a rising edge. The data is transferred from the area specified by DATA and LEN. |
| EN_R IN | Bool | TRCV: Enables the CPU to receive; with EN_R = 1, the TRCV is ready to receive. The receive job is processed. |
| ID IN | CONN_OUC (Word) | Reference to the associated connection. ID must be identical to the associated parameter ID in the local connection description. Value range: W#16#0001 to W#16#0FFF |
| LEN IN | UInt | Maximum number of bytes to be sent (TSEND) or received (TRCV): <ul style="list-style-type: none"> • Default = 0: The DATA parameter determines the length of the data to be sent (TSEND) or received (TRCV). • Ad hoc mode = 65535: A variable length of data is set for reception (TRCV). |
| DATA IN_OUT | Variant | Pointer to send (TSEND) or receive (TRCV) data area; data area contains the address and length. The address refers to I memory, Q memory, M memory, or a DB. |
| DONE OUT | Bool | TSEND: <ul style="list-style-type: none"> • 0: Job not yet started or still running. • 1: Job executed without error. |

| Parameter and type | | Data type | Description |
|--------------------|-----|-----------|---|
| NDR | OUT | Bool | TRCV: <ul style="list-style-type: none"> NDR = 0: Job not yet started or still running. NDR = 1: Job successfully completed. |
| BUSY | OUT | Bool | <ul style="list-style-type: none"> BUSY = 1: The job is not yet complete. A new job cannot be triggered. BUSY = 0: Job is complete. |
| ERROR | OUT | Bool | ERROR = 1: Error occurred during processing. STATUS provides detailed information on the type of error |
| STATUS | OUT | Word | Status information including error information. (Refer to the Error and Status condition codes in the table below.) |
| RCVD_LEN | OUT | Int | TRCV: Amount of data actually received in bytes |

Note

The TSEND instruction requires a low-to-high transition at the REQ input parameter to start a send job. The BUSY parameter is then set to 1 during processing. Completion of the send job is indicated by either the DONE or ERROR parameters being set to 1 for one scan. During this time, any low-to-high transition at the REQ input parameter is ignored.

TRCV Operations

The TRCV instruction writes the received data to a receive area that is specified by the following two variables:

- Pointer to the start of the area
- Length of the area or the value supplied at the LEN input if not 0

Note

The default setting of the LEN parameter (LEN = 0) uses the DATA parameter to determine the length of the data being transmitted. Ensure that the DATA transmitted by the TSEND instruction is the same size as the DATA parameter of the TRCV instruction.

As soon as all the job data has been received, TRCV transfers it to the receive area and sets NDR to 1.

Table 10- 12 Entering the data into the receive area

| Protocol variant | Entering the data in the receive area | Parameter "connection_type" | Value of the LEN parameter | Value of the RCVD_LEN parameter (bytes) |
|------------------|---------------------------------------|-----------------------------|--|---|
| TCP | Ad hoc mode | B#16#11 | 65535 | 1 to 1472 |
| TCP | Data reception with specified length | B#16#11 | 0 (recommended) or 1 to 8192, except 65535 | 1 to 8192 |
| ISO on TCP | Ad hoc mode | B#16#12 | 65535 | 1 to 1472 |
| ISO on TCP | protocol-controlled | B#16#12 | 0 (recommended) or 1 to 8192, except 65535 | 1 to 8192 |

Note

Ad hoc mode

The "ad hoc mode" exists with the TCP and ISO on TCP protocol variants. You set "ad hoc mode" by assigning "65535" to the LEN parameter. The receive area is identical to the area formed by DATA. The length of the received data will be output to the parameter RCVD_LEN. Immediately after receiving a block of data, TRCV enters the data in the receive area and sets NDR to 1.

If you store the data in an "optimized" DB (symbolic only), you can receive data only in arrays of Byte, Char, USInt, and SInt data types.

Note

Importing of S7-300/400 STEP 7 projects containing "ad hoc mode" into the S7-1200

In S7-300/400 STEP 7 projects, "ad hoc mode" is selected by assigning "0" to the LEN parameter. In the S7-1200, you set "ad hoc mode" by assigning "65535" to the LEN parameter.

If you import an S7-300/400 STEP 7 project containing "ad hoc mode" into the S7-1200, you must change the LEN parameter to "65535".

TSEND and TRCV Error and Status condition codes

| ERROR | STATUS | Description |
|-------|--------|--|
| 0 | 0000 | <ul style="list-style-type: none"> Send job completed without error (TSEND) New data accepted: The current length of the received data is shown in RCVD_LEN (TRCV). |
| 0 | 7000 | <ul style="list-style-type: none"> No job processing active (TSEND) Block not ready to receive (TRCV) |
| 0 | 7001 | <ul style="list-style-type: none"> Start of job processing, data being sent: During this processing the operating system accesses the data in the DATA send area (TSEND). Block is ready to receive, receive job was activated (TRCV). |
| 0 | 7002 | <ul style="list-style-type: none"> Follow-on instruction execution (REQ irrelevant), job being processed: The operating system accesses the data in the DATA send area during this processing (TSEND). Follow-on instruction execution, receive job being processed: Data is written to the receive area during this processing. For this reason, an error could result in inconsistent data in the receive area (TRCV). |
| 1 | 8085 | <ul style="list-style-type: none"> LEN parameter is greater than the largest permitted value (TSEND) and (TRCV). LEN or DATA parameter changed since the first instruction execution (TRCV). |
| 1 | 8086 | The ID parameter is not in the permitted address range. |
| 1 | 8088 | The LEN parameter is larger than the memory area specified in DATA. |
| 1 | 80A1 | Communications error: <ul style="list-style-type: none"> The specified connection has not yet established (TSEND and TRCV). The specified connection is currently being terminated. Transmission or a receive job over this connection is not possible (TSEND and TRCV). The interface is being reinitialized (TSEND). The interface is receiving new parameters (TRCV). |
| 1 | 80C3 | Internal lack of resources: A block with this ID is already being processed in a different priority class. |
| 1 | 80C4 | Temporary communications error: <ul style="list-style-type: none"> The connection to the communications partner cannot be established at this time. The interface is receiving new parameter settings, or the connection is currently being established. |

Connection Ethernet protocols

Every CPU has an integrated PROFINET port, which supports standard PROFINET communications. The TSEND_C, TRCV_C, TSEND and TRCV instructions all support the TCP and ISO on TCP Ethernet protocols.

Refer to "Device Configuration: Configuring the Local/Partner connection path (Page 150)" for more information.

10.2.2.7 UDP

UDP is a standard protocol described by RFC 768: User Datagram Protocol. UDP provides a mechanism for one application to send a datagram to another; however, delivery of data is not guaranteed. This protocol has the following features:

- A quick communications protocol, because it is very hardware-intimate
- Suitable for small-sized to medium data amounts (up to 1472 bytes)
- UDP is a simpler transport control protocol than TCP, with a thin layer that yields low overheads
- Can be used very flexibly with many third-party systems
- Routing-capable
- Uses port numbers to direct the datagrams
- Messages are unacknowledged: The application is required to take responsibility for error recovery and security
- Programming effort is required for data management due to the SEND / RECEIVE programming interface

UDP supports broadcast communication. To use broadcast, you must configure the IP address portion of the ADDR configuration. For example: A CPU with an IP address of 192.168.2.10 and subnet mask of 255.255.255.0 would use a broadcast address of 192.168.2.255.

10.2.2.8 TUSEND and TURCV

The following instructions control the UDP communication process:

- TCON establishes the communication between the client and server (CPU) PC.
- TUSEND and TURCV send and receive data.
- TDISCON disconnects the communication between the client and server.

Refer to TCON, TDISCON, TSEND, and TRCV (Page 527) in the "TCP and ISO-on-TCP" section for more information on the TCON and TDISCON communication instructions.

Table 10- 13 TUSEND and TURCV instructions

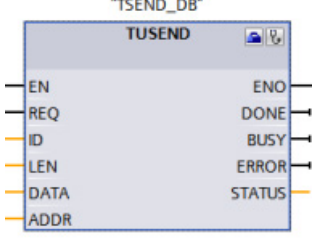
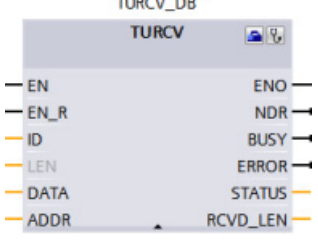
| LAD / FBD | SCL | Description |
|---|--|--|
|  | <pre>"TUSEND_DB" (req:=_bool_in_, ID:=_word_in_, len:=_udint_in_, done=>_bool_out_, busy=>_bool_out_, error=>_bool_out_, status=>_word_out_, data:=_variant_inout_);</pre> | <p>The TUSEND instruction sends data via UDP to the remote partner specified by the parameter ADDR.</p> <p>To start the job for sending data, call the TUSEND instruction with REQ = 1.</p> |
|  | <pre>"TURCV_DB" (en_r:=_bool_in_, ID:=_word_in_, len:=_udint_in_, ndr=>_bool_out_, busy=>_bool_out_, error=>_bool_out_, status=>_word_out_, rcvd_len=>_udint_out_, data:=_variant_inout_);</pre> | <p>The TURCV instruction receives data via UDP. The parameter ADDR shows the address of the sender. After successful completion of TURCV, the parameter ADDR contains the address of the remote partner (the sender).</p> <p>TURCV does not support ad hoc mode.</p> <p>To start the job for receiving data, call the TURCV instruction with EN_R = 1.</p> |

¹ STEP 7 automatically creates the DB when you insert the instruction.

TCON, TDISCON, TUSEND, and TURCV operate asynchronously, which means that the job processing extends over multiple instruction executions.

Table 10- 14 TUSEND and TURCV data types for the parameters

| Parameter and type | Data type | Description | |
|--------------------|-----------|-------------|---|
| REQ (TUSEND) | IN | Bool | Starts the send job on a rising edge. The data is transferred from the area specified by DATA and LEN. |
| EN_R (TURCV) | IN | Bool | <ul style="list-style-type: none"> 0: CPU cannot receive. 1: Enables the CPU to receive. The TURCV instruction is ready to receive, and the receive job is processed. |
| ID | IN | Word | Reference to the associated connection between the user program and the communication level of the operating system. ID must be identical to the associated parameter ID in the local connection description. Range of values: W#16#0001 to W#16#0FFF. |
| LEN | IN | UDInt | Number of bytes to be sent (TUSEND) or received (TURCV). <ul style="list-style-type: none"> Default = 0. The DATA parameter determines the length of the data to be sent or received. Otherwise, range of values: 1 to 1472 |
| DONE (TUSEND) | IN | Bool | Status parameter DONE (TUSEND): <ul style="list-style-type: none"> 0: Job is not yet started or still running. 1: Job completed without error. |

| Parameter and type | | Data type | Description |
|--------------------|--------|-----------|--|
| NDR (TURCV) | OUT | Bool | Status parameter NDR (TURCV): <ul style="list-style-type: none"> 0: Job not yet started or still running. 1: Job has successfully completed. |
| BUSY | OUT | Bool | <ul style="list-style-type: none"> 1: Job is not yet completed. A new job cannot be triggered. 0: Job has completed. |
| ERROR | OUT | Bool | Status parameters with the following values: <ul style="list-style-type: none"> 0: No error 1: Error occurred during processing. STATUS provides detailed information on the type of error. |
| STATUS | OUT | Word | Status information including error information. (Refer to the Error and Status condition codes in the table below.) |
| RCVD_LEN | OUT | UDInt | Number of bytes received (TURCV) |
| DATA | IN_OUT | Variant | Address of the sender area (TUSEND) or receive area (TURCV): <ul style="list-style-type: none"> The process image input table The process image output table A memory bit A data block |
| ADDR | IN_OUT | Variant | Pointer to the address of the receiver (for TUSEND) or sender (for TURCV) (for example, P#DB100.DBX0.0 byte 8). The pointer may point to any memory area. A structure of 8 bytes is required as follows: <ul style="list-style-type: none"> First 4 bytes contain the remote IP address. Next 2 bytes specify the remote port number. Last 2 bytes are reserved. |

The job status is indicated at the output parameters BUSY and STATUS. STATUS corresponds to the RET_VAL output parameter of asynchronously functioning instructions.

The following table shows the relationships between BUSY, DONE (TUSEND), NDR (TURCV), and ERROR. Using this table, you can determine the current status of the instruction (TUSEND or TURCV) or when the sending (transmission) / receiving process is complete.

Table 10- 15 Status of BUSY, DONE (TUSEND) / NDR (TURCV), and ERROR parameters

| BUSY | DONE / NDR | ERROR | Description |
|-------|------------|------------|---|
| TRUE | irrelevant | irrelevant | The job is being processed. |
| FALSE | TRUE | FALSE | The job was completed successfully. |
| FALSE | FALSE | TRUE | The job was ended with an error. The cause of the error can be found in the STATUS parameter. |
| FALSE | FALSE | FALSE | The instruction was not assigned a (new) job. |

¹ Due to the asynchronous function of the instructions: For TUSEND, you must keep the data in the sender area consistent until the DONE parameter or the ERROR parameter assumes the value TRUE. For TURCV, the data in the receiver area are only consistent when the NDR parameter assumes the value TRUE.

Table 10- 16 TUSEND and TURCV condition codes for ERROR and STATUS

| ERROR | STATUS | Description |
|-------|--------|--|
| 0 | 0000 | <ul style="list-style-type: none"> Send job completed without error (TUSEND). New data were accepted. The current length of the received data is shown in RCVD_LEN (TURCV). |
| 0 | 7000 | <ul style="list-style-type: none"> No job processing active (TUSEND) Block not ready to receive (TURCV) |
| 0 | 7001 | <ul style="list-style-type: none"> Start of job processing, data being sent (TUSEND): During this processing, the operating system accesses the data in the DATA send area. Block is ready to receive, receive job was activated (TURCV). |
| 0 | 7002 | <ul style="list-style-type: none"> Follow-on instruction execution (REQ irrelevant), job being processed (TUSEND): During this processing, the operating system accesses the data in the DATA send area. Follow-on instruction execution, job being processed: During this processing, the TURCV instruction writes data to the receive area. For this reason, an error could result in inconsistent data in the receive area. |
| 1 | 8085 | LEN parameter is greater than the largest permitted value, has the value 0 (TUSEND), or you changed the value of the LEN or DATA parameter since the first instruction execution (TURCV). |
| 1 | 8086 | The ID parameter is not in the permitted address range. |
| 1 | 8088 | <ul style="list-style-type: none"> LEN parameter is larger than the memory area (TUSEND) or receive area (TURCV) specified in DATA. Receive area is too small (TURCV). |
| 1 | 8089 | ADDR parameter does not point to a data block. |
| 1 | 80A1 | Communications error: <ul style="list-style-type: none"> The specified connection between user program and communications layer of the operating system has not yet been established. The specified connection between the user program and the communication layer of the operating system is currently being terminated. Transmission (TUSEND) or a receive job (TURCV) over this connection is not possible. The interface is being reinitialized. |
| 1 | 80A4 | IP address of the remote connection end point is invalid; it is possible that it matches the local IP address (TUSEND). |
| 1 | 80B3 | <ul style="list-style-type: none"> The set protocol variant (connection_type parameter in the connection description) is not UDP. Please use the TSEND or TRCV instruction. ADDR parameter: Invalid settings for port number (TUSEND) |

| ERROR | STATUS | Description |
|-------|--------|---|
| 1 | 80C3 | <ul style="list-style-type: none"> • A block with this ID is already being processed in a different priority class. • Internal lack of resources |
| 1 | 80C4 | Temporary communications error: <ul style="list-style-type: none"> • The connection between the user program and the communication level of the operating system cannot be established at this time (TUSEND). • The interface is receiving new parameters (TUSEND). • The connection is currently being reinitiated (TURCV). |

Connection Ethernet protocols

Every CPU has an integrated PROFINET port, which supports standard PROFINET communications. The TUSEND and TURCV instructions support the UDP Ethernet protocol.

Refer to "Configuring the Local/Partner connection path" (Page 150)" in the "Device configuration" chapter for more information.

Operations

Both partners are passive in UDP communication. Typical parameter start values for the "TCON_Param" data type are shown in the following figures. Port numbers (LOCAL_TSAP_ID) are written in a 2-byte format. All ports except for 161, 34962, 34963, and 34964 are allowed.

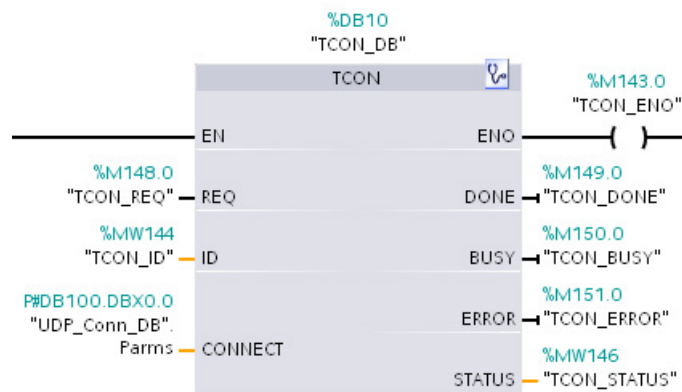

| UDP_Conn_DB | | | | | |
|-------------|--------------------|----------------------|--------|---------------|--|
| | Name | Data type | Offset | Initial value | Comment |
| 1 | ▼ Static | | | | |
| 2 | ▼ Params | TCON_Param | 0.0 | | |
| 3 | BLOCK_LENGTH | UInt | 0.0 | 64 | byte length of SDT |
| 4 | ID | CONN_OUC | 2.0 | 1 | reference to the connection |
| 5 | CONNECTION_TYPE | USInt | 4.0 | 19 | 17: TCP/IP, 18: ISO on TCP |
| 6 | ACTIVE_EST | Bool | 5.0 | false | active/passive connection establishment |
| 7 | LOCAL_DEVICE_ID | USInt | 6.0 | 1 | 1: local IE interface |
| 8 | LOCAL_TSAP_ID_L... | USInt | 7.0 | 2 | byte length of local TSAP id/port number |
| 9 | REM_SUBNET_ID_... | USInt | 8.0 | 0 | byte length of remote subnet id |
| 10 | REM_STADDR_LEN | USInt | 9.0 | 0 | byte length of remote IP address |
| 11 | REM_TSAP_ID_LEN | USInt | 10.0 | 0 | byte length of remote port/TSAP id |
| 12 | NEXT_STADDR_LEN | USInt | 11.0 | 0 | byte length of next station address |
| 13 | ▼ LOCAL_TSAP_ID | Array[1..16] of Byte | 12.0 | | TSAP id/local port number |
| 14 | LOCAL_TSAP_I... | Byte | | B#16#07 | |
| 15 | LOCAL_TSAP_I... | Byte | | B#16#D0 | |

The TUSEND instruction sends data through UDP to the remote partner specified in the "TADDR_Param" data type. The TURCV instruction receives data through UDP. After a successful execution of the TURCV instruction, the "TADDR_Param" data type shows the address of the remote partner (the sender), as shown in the figures below.

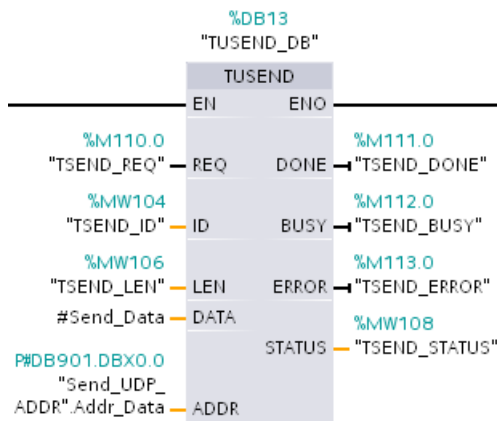

| Send_UDP_ADDR | | | | | |
|---------------|----------------|----------------------|--------|---------------|------------------------|
| | Name | Data type | Offset | Initial value | Comment |
| 1 | ▼ Static | | | | |
| 2 | ▼ Addr_Data | TADDR_Param | 0.0 | | |
| 3 | ▼ REM_IP_ADDR | Array[1..4] of USInt | 0.0 | | remote station address |
| 4 | REM_IP_ADDR[1] | USInt | | 192 | |
| 5 | REM_IP_ADDR[2] | USInt | | 168 | |
| 6 | REM_IP_ADDR[3] | USInt | | 2 | |
| 7 | REM_IP_ADDR[4] | USInt | | 10 | |
| 8 | REM_PORT_Nr | UInt | 4.0 | 2000 | remote port number |
| 9 | RESERVED | Word | 6.0 | 0 | unused; has to be 0 |

10.2.2.9 T_CONFIG

The T_CONFIG instruction changes the IP configuration parameters of the PROFINET port from the user program, allowing the permanent change or setting of the following features:

- Station name
- IP address
- Subnet mask
- Router address

Note

Located in the CPU "Properties", "Ethernet address" page, the "Set IP address using a different method" (Page 546) radio button allows you to change the IP address online or by using the "T_CONFIG" instruction after the program is downloaded. This IP address assignment method is for the CPU only.

Located in the CPU "Properties", "Ethernet address" page, the "Set PROFINET device name using a different method" (Page 547) radio button allows you to change the PROFINET device name online or by using the "T_CONFIG" instruction after the program is downloaded. This PROFINET device name assignment method is for the CPU only.

WARNING

Changing IP configuration parameter with T_CONFIG causes a CPU restart.

After you use the T_CONFIG to change an IP configuration parameter, the CPU restarts. The CPU goes to STOP mode, performs a warm restart, and returns to RUN mode.

Do not use the T_CONFIG instruction in a production environment. Control devices can fail in an unsafe condition, resulting in unexpected operation of controlled equipment. Such unexpected operations could result in death or serious injury to personnel, and/or damage to equipment.

Ensure that your process will go to a safe state when the CPU performs a warm restart as a result of T_CONFIG instruction execution. A warm restart does not reset memory. A warm restart does initialize all non-retentive system and user data and retains the values of all retentive user data.

Note

You should not attempt to execute more than one T_CONFIG instruction at a time.

Table 10- 17 T_CONFIG instruction

| LAD / FBD | SCL | Description |
|-----------|--|---|
| | <pre>"T_CONFIG_DB" (req:=_bool_in_, interface:=_word_in_, conf_Data:=_variant_in_, done=>_bool_out_, busy=>_bool_out_, error=>_bool_out_, status=>_dword_out_, err_loc=>_word_out_);</pre> | <p>Use the T_CONFIG instruction to change the IP configuration parameters from your user program. T_CONFIG works asynchronously. The execution extends over multiple calls.</p> |

Table 10- 18 T_CONFIG data types for the parameters

| Parameter and type | Data type | Description |
|--------------------|--------------|---|
| REQ Input | Bool | Starts the instruction on the rising edge. |
| INTERFACE Input | HW_Interface | ID of network interface |
| CONF_DATA Input | Variant | Reference to the structure of the configuration data; CONF_DATA is defined by a System Data Type (SDT). |
| DONE Output | Bool | <ul style="list-style-type: none"> 0: Job has not yet started or is still running. 1: Job was executed without error. |
| BUSY Output | Bool | <ul style="list-style-type: none"> 0: The job is complete. 1: The job is not yet complete. A new job cannot be triggered. |
| ERROR Output | Bool | Status parameters with the following values: <ul style="list-style-type: none"> 0: No error 1: Error occurred during processing. STATUS provides detailed information on the type of error. |
| STATUS Output | DWord | Status information including error information. (Refer to the Error and Status condition codes in the table below.) |
| ERR_LOC Output | DWord | Fault location (field ID and subfield ID of the error parameter) |

The IP configuration information is placed in the CONF_DATA data block, along with a Variant pointer on parameter CONF_DATA referenced above. The successful execution of the T_CONFIG instruction ends with the handover of the IP configuration data to the network interface. Errors are assigned to the STATUS output parameter.

Table 10- 19 Condition codes for ERROR and STATUS

| ERROR | STATUS (DW#16#...) | Description |
|-------|--------------------|--|
| 0 | 00000000 | No error Note: If the instruction executes successfully, the "no error" status may not be returned. |
| 0 | 00700000 | The job is not finished (BUSY = 1). |
| 0 | 00700100 | Start of job execution |

| ERROR | STATUS (DW#16#...) | Description |
|-------|-----------------------|--|
| 0 | 00700200 | Intermediate call (REQ irrelevant) |
| 1 | C08xyy00 | General failure |
| 1 | C0808000 | LADDR parameters for identification of the interface are invalid. |
| 1 | C0808100 | LADDR parameters for identification of the interface have been assigned a non-supported hardware interface. |
| 1 | C0808200 | CONF_DATA parameter error: Data type of the Variant pointer does not match the data type Byte. |
| 1 | C0808300 | CONF_DATA parameter error: The area pointer is not in the DB of the Variant pointer. |
| 1 | C0808400 | CONF_DATA parameter error: The Variant pointer is the wrong length. |
| 1 | C0808600 | Reserved |
| 1 | C0808700 | Inconsistency in the CONF_DATA data block length to the IP configuration |
| 1 | C0808800 | The parameters of the CONF_DATA data block field_type_id are invalid. (Only field_type_id = 0 is allowed.) |
| 1 | C0808900 | The parameters of the CONF_DATA data block field_type_id are invalid or have been used several times. |
| 1 | C0808A00 | LEN length of the IP configuration parameters or subfield_cnt errors |
| 1 | C0808B00 | The IP configuration ID parameter is invalid or unsupported. |
| 1 | C0808C00 | The Sub-block of the IP configuration is incorrectly placed (Sub-block wrong, wrong order, or used multiple times). |
| 1 | C0808D00 | The length of a statement LEN Sub-blocks is invalid. |
| 1 | C0808E00 | The value of the parameter in Sub-blocks mode is invalid. |
| 1 | C0808F00 | Sub-block conflict between the IP configuration and a previous Sub-block. |
| 1 | C0809000 | The parameters of the subfield are write-protected (for example: parameters are specified by configuration, or PNIO mode is enabled). |
| 1 | C0809100 | Reserved |
| 1 | C0809400 | A parameter in the Sub-block IP configuration has not been defined or may not be used. |
| 1 | C0809500 | There is an inconsistency between a parameter of the Sub-block IP configuration and other parameters. |
| 1 | C080C200 | Instruction cannot be executed. This error can occur if, for example, communication with the interface has been lost. |
| 1 | C080C300 | There are not enough resources. This error can occur if, for example, the instruction is called multiple times with different parameters |
| 1 | C080C400 | Communication failure. The error can occur temporarily and will require a repeat of the user program. |
| 1 | C080D200 | Execution of the instruction is not supported by the PROFINET interface. |

CONF_DATA Data block

The following diagram shows how the configuration data to be transferred is stored in the configuration DB.

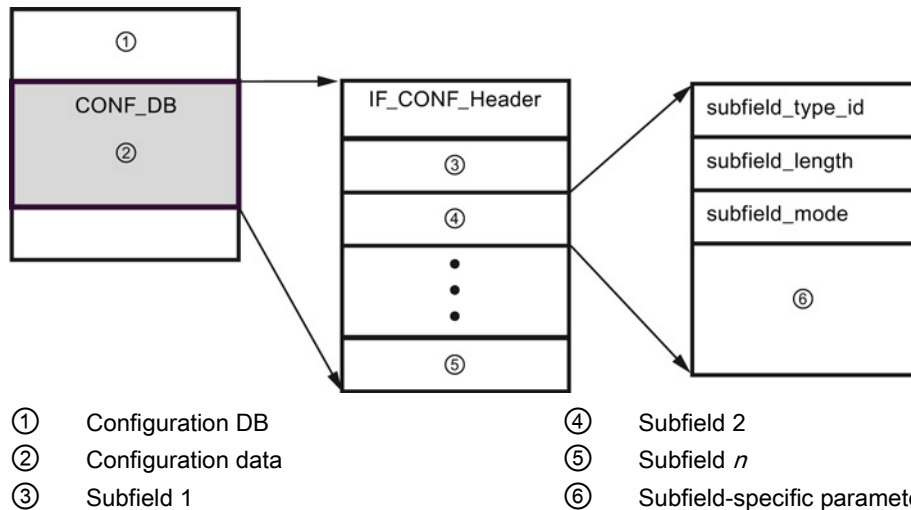

The configuration data of CONF_DB consists of a field that contains a header (IF_CONF_Header) and several subfields. IF_CONF_Header provides the following elements:

- field_type_id (data type UInt): Zero
- field_id (data type UInt): Zero
- subfield_cnt (data type UInt): Number of subfields

Each subfield consists of a header (subfield_type_id, subfield_length, subfield_mode) and the subfield-specific parameters. Each subfield must consist of an even number of bytes. The subfield_mode supports a value of 1.

Note

Only one field (IF_CONF_Header) is currently allowed. Its parameters field_type_id and field_id must have the value zero. Other fields with different values for field_type_id and field_id are subject to future extensions.

In the IF_CONF_Header field, only two subfields, "addr" (IP address) and "nos" (Name of station) are currently allowed.

Table 10- 20 Subfields supported

| subfield_type_id | Data type | Explanation |
|------------------|-------------|--|
| 30 | IF_CONF_V4 | IP parameters: IP address, subnet mask, router address |
| 40 | IF_CONF_NOS | PROFINET IO device name (Name of station) |

Table 10- 21 Elements of the IF_CONF_V4 data type

| Name | Data type | Start value | Description | | |
|------------------|----------------------|-------------|------------------------------|---------|----------------------------|
| Id | UInt | 30 | subfield_type_id | | |
| len | UInt | 18 | subfield_length | | |
| mode | UInt | 1 | subfield_mode (1: permanent) | | |
| InterfaceAddress | IP_V4 | - | Interface address | | |
| ADDR | Array [1..4] of Byte | | | | |
| ADDR[1] | Byte | | | b#16#C8 | IP address high byte: 200 |
| ADDR[2] | Byte | | | b#16#0C | IP address high byte: 12 |
| ADDR[3] | Byte | | | b#16#01 | IP address low byte: 1 |
| ADDR[4] | Byte | b#16#90 | IP address low byte: 144 | | |
| SubnetMask | IP_V4 | - | Subnet mask | | |
| ADDR | Array [1..4] of Byte | | | | |
| ADDR[1] | Byte | | | b#16#FF | Subnet mask high byte: 255 |
| ADDR[2] | Byte | | | b#16#FF | Subnet mask high byte: 255 |
| ADDR[3] | Byte | | | b#16#FF | Subnet mask low byte: 255 |
| ADDR[4] | Byte | b#16#00 | Subnet mask low byte: 0 | | |
| DefaultRouter | IP_V4 | - | Default router | | |
| ADDR | Array [1..4] of Byte | | | | |
| ADDR[1] | Byte | | | b#16#C8 | Router high byte: 200 |
| ADDR[2] | Byte | | | b#16#0C | Router high byte: 12 |
| ADDR[3] | Byte | | | b#16#01 | Router low byte: 1 |
| ADDR[4] | Byte | b#16#01 | Router low byte: 1 | | |

Table 10- 22 Elements of the IF_CONF_NOS data type

| Name | Data type | Start value | Description |
|-----------------------|-----------------------|-------------|---|
| id | UInt | 40 | subfield_type_id |
| len | UInt | 246 | subfield_length |
| mode | UInt | 1 | subfield_mode (1: permanent) |
| Nos (Name of station) | Array[1..240] of Byte | 0 | Station name: You must occupy the ARRAY from the first byte. If the ARRAY is longer than the station name to be assigned, you must enter a zero byte after the actual station name (in conformity with IEC 61158-6-10). Otherwise, nos is rejected and the "T_CONFIG (Page 541)" instruction enters the error code DW#16#C0809400 in STATUS. If you occupy the first byte with zero, the station name is deleted. |

The station name is subject to the following limitations:

- A name component within the station name, i.e., a character string between two dots, must not exceed 63 characters.
- No special characters such as umlauts, brackets, underscore, slash, blank space, etc. The only special character permitted is the dash.
- The station name must not begin or end with the "-" character.
- The station name must not begin with a number.
- The station name form n.n.n.n (n = 0, ... 999) is not permitted.
- The station name must not begin with the string "port-xyz" or "port-xyz-abcde" (a, b, c, d, e, x, y, z = 0, ... 9).

Note

You can also create an ARRAY "nos" that is shorter than 240 bytes, but not less than 2 bytes. In this case, you must adjust the "len" (length of subfield) tag accordingly.

How to change IP parameters

In the following example, in the "addr" subfield, the "InterfaceAddress" (IP address), "SubnetMask", and "DefaultRouter" (IP router) are changed. In the CPU "Properties", "Ethernet address" page, the "Set IP address using a different method" radio button must be clicked to enable you to change the IP address using the "T_CONFIG" instruction after the program is downloaded.

| CONF_DATA_1 | | | |
|-------------|------------------|----------------------|-------------|
| | Name | Data type | Start value |
| 1 | Static | | |
| 2 | Conf_data | Struct | |
| 3 | header | IF_CONFIG_Header | |
| 4 | FieldType | UInt | 0 |
| 5 | FieldId | UInt | 0 |
| 6 | SubfieldCount | UInt | 1 |
| 7 | addr | IF_CONFIG_V4 | |
| 8 | Id | UInt | 30 |
| 9 | Length | UInt | 18 |
| 10 | Mode | UInt | 1 |
| 11 | InterfaceAddress | IP_V4 | |
| 12 | ADDR | array [1..4] of Byte | |
| 13 | ADDR[1] | Byte | 192 |
| 14 | ADDR[2] | Byte | 168 |
| 15 | ADDR[3] | Byte | 2 |
| 16 | ADDR[4] | Byte | 30 |
| 17 | SubnetMask | IP_V4 | |
| 18 | ADDR | array [1..4] of Byte | |
| 19 | ADDR[1] | Byte | 255 |
| 20 | ADDR[2] | Byte | 255 |
| 21 | ADDR[3] | Byte | 255 |
| 22 | ADDR[4] | Byte | 0 |
| 23 | DefaultRouter | IP_V4 | |
| 24 | ADDR | array [1..4] of Byte | |
| 25 | ADDR[1] | Byte | 192 |
| 26 | ADDR[2] | Byte | 168 |
| 27 | ADDR[3] | Byte | 2 |
| 28 | ADDR[4] | Byte | 1 |

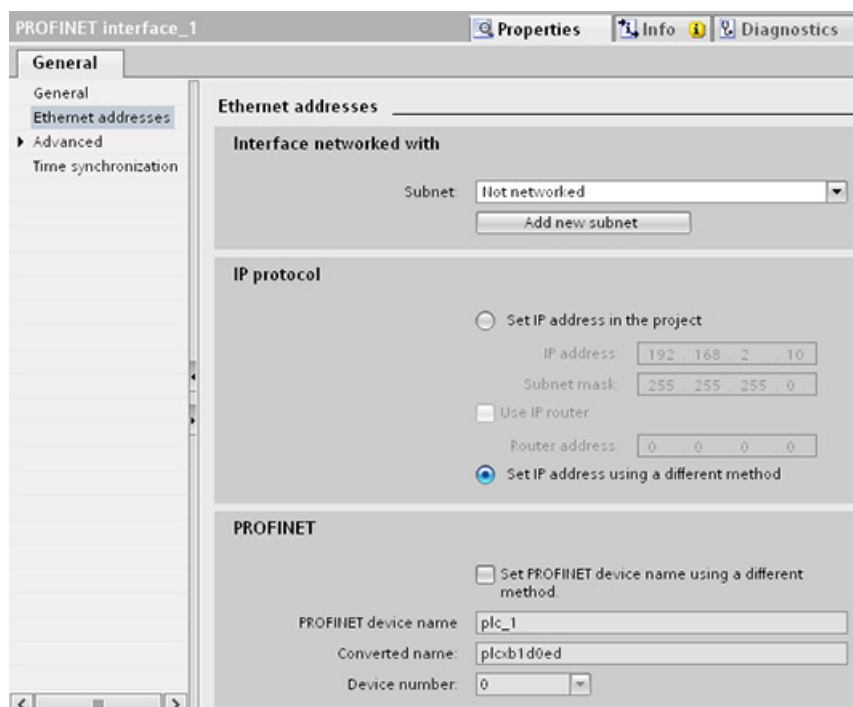

How to change IP parameters and PROFINET IO device names

In the following example, both the "addr" and "nos" (Name of station) subfields are changed. In the CPU "Properties", "Ethernet address" page, the "Set PROFINET device name using a different method" radio button must be clicked to enable you to change the PROFINET device name using the "T_CONFIG" instruction after the program is downloaded.

| CONF_DATA_2 | | | |
|-------------|------------------|------------------------|-------------|
| | Name | Data type | Start value |
| 1 | Static | | |
| 2 | Conf_data | Struct | |
| 3 | header | IF_CONF_Header | |
| 4 | Fieldtype | UInt | 0 |
| 5 | Fieldid | UInt | 0 |
| 6 | SubfieldCount | UInt | 2 |
| 7 | addr | IF_CONF_v4 | |
| 8 | Id | UInt | 30 |
| 9 | Length | UInt | 18 |
| 10 | Mode | UInt | 1 |
| 11 | InterfaceAddress | IP_V4 | |
| 12 | ADDR | array [1..4] of Byte | |
| 13 | SubnetMask | IP_V4 | |
| 14 | ADDR | array [1..4] of Byte | |
| 15 | DefaultRouter | IP_V4 | |
| 16 | ADDR | array [1..4] of Byte | |
| 17 | nos | IF_CONF_NOS | |
| 18 | Id | UInt | 40 |
| 19 | Length | UInt | 246 |
| 20 | Mode | UInt | 1 |
| 21 | NOS | array [1..240] of Byte | |

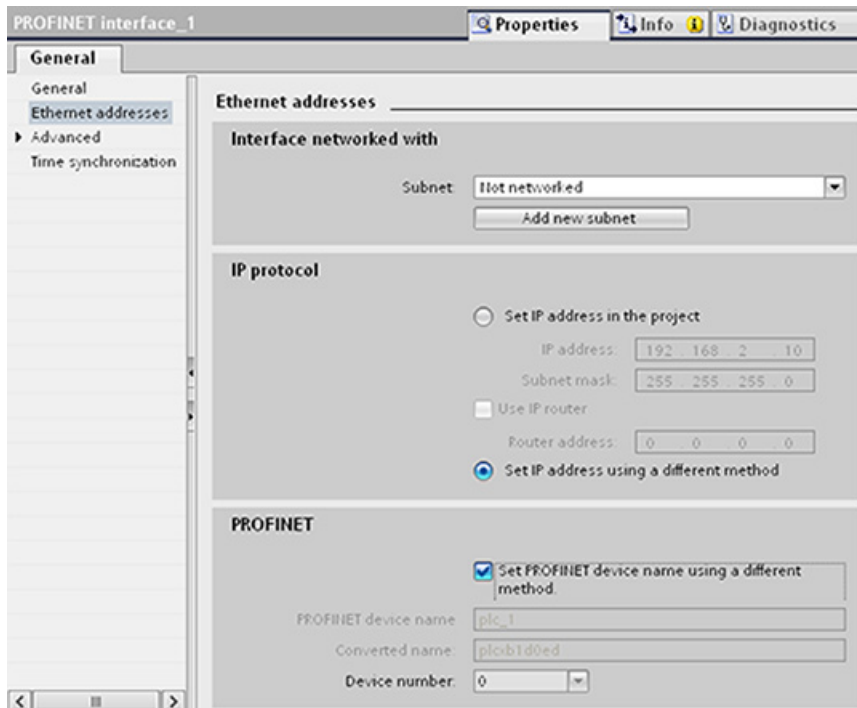

10.2.2.10 Common parameters for instructions

REQ input parameter

Many of the Open User Communication instructions use the REQ input to initiate the operation on a low to high transition. The REQ input must be high (TRUE) for one execution of an instruction, but the REQ input can remain TRUE for as long as desired. The instruction does not initiate another operation until it has been executed with the REQ input FALSE so that the instruction can reset the history state of the REQ input. This is required so that the instruction can detect the low to high transition to initiate the next operation.

When you place one of these instructions in your program, STEP 7 prompts you to identify the instance DB. Use a unique DB for each instruction call. This ensures that each instruction properly handles inputs such as REQ.

ID input parameter

This is a reference to the "Local ID (hex)" on the "Network view" of "Devices and networks" in STEP 7 and is the ID of the network that you want to use for this communication block. The ID must be identical to the associated parameter ID in the local connection description.

DONE, NDR, ERROR, and STATUS output parameters

These instructions provide outputs describing the completion status:

Table 10- 23 Open User Communication instruction output parameters

| Parameter | Data type | Default | Description |
|-----------|-----------|---------|--|
| DONE | Bool | FALSE | Is set TRUE for one execution to indicate that the last request completed without errors; otherwise, FALSE. |
| NDR | Bool | FALSE | Is set TRUE for one execution to indicate that the requested action has completed without error and new data has been received; otherwise, FALSE. |
| BUSY | Bool | FALSE | Is set TRUE when active to indicate that: <ul style="list-style-type: none"> • The job is not yet complete. • A new job cannot be triggered. Is set FALSE when job is complete. |
| ERROR | Bool | FALSE | Is set TRUE for one execution to indicate that the last request completed with errors, with the applicable error code in STATUS; otherwise, FALSE. |
| STATUS | Word | 0 | Result status: <ul style="list-style-type: none"> • If the DONE or NDR bit is set, then STATUS is set to 0 or to an informational code. • If the ERROR bit is set, then STATUS is set to an error code. • If none of the above bits are set, then the instruction returns status results that describe the current state of the function. STATUS retains its value for the duration of the execution of the function. |

Note

Note that DONE, NDR, and ERROR are set for one execution only.

Restricted TSAPs and port numbers for passive ISO and TCP communication

If you use the "TCON" instruction to set up and establish a passive communications connection, the following port addresses are restricted and should not be used:

- ISO TSAP (passive):
 - 01.00, 01.01, 02.00, 02.01, 03.00, 03.01
 - 10.00, 10.01, 11.00, 11.01, ... BF.00, BF.01
- TCP port (passive): 5001, 102, 123, 20, 21, 25, 34962, 34963, 34964, 80
- UDP port (passive): 161, 34962, 34963, 34964

10.2.3 Communication with a programming device

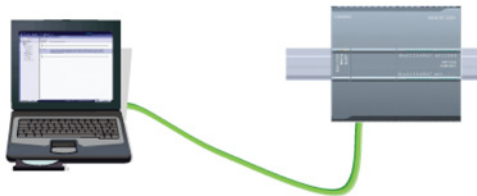

A CPU can communicate with a STEP 7 programming device on a network.

Consider the following when setting up communications between a CPU and a programming device:

- Configuration/Setup: Hardware configuration is required.
- No Ethernet switch is required for one-to-one communications; an Ethernet switch is required for more than two devices in a network.

10.2.3.1 Establishing the hardware communications connection

The PROFINET interfaces establish the physical connections between a programming device and a CPU. Since Auto-Cross-Over functionality is built into the CPU, either a standard or crossover Ethernet cable can be used for the interface. An Ethernet switch is not required to connect a programming device directly to a CPU.

Follow the steps below to create the hardware connection between a programming device and a CPU:

1. Install the CPU (Page 56).
2. Plug the Ethernet cable into the PROFINET port shown below.
3. Connect the Ethernet cable to the programming device.

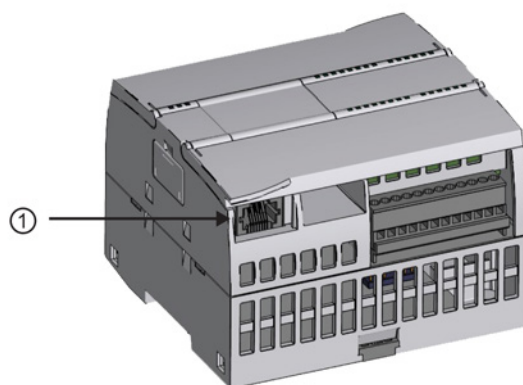

① PROFINET port

An optional strain relief is available to strengthen the PROFINET connection.

10.2.3.2 Configuring the devices

If you have already created a project with a CPU, open your project in STEP 7.

If not, create a project and insert a CPU (Page 138) into the rack. In the project below, a CPU is shown in the "Device View".

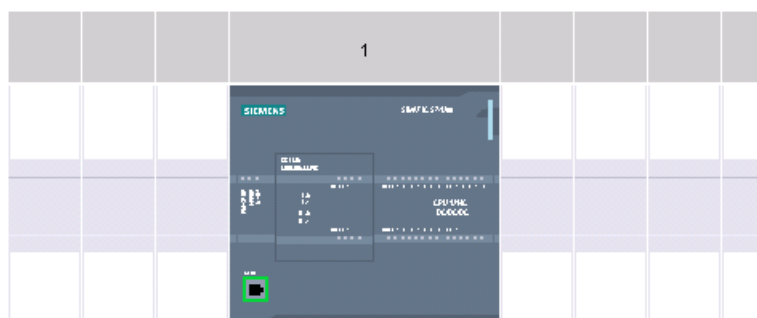

10.2.3.3 Assigning Internet Protocol (IP) addresses

Assigning the IP addresses

In a PROFINET network, each device must also have an Internet Protocol (IP) address. This address allows the device to deliver data on a more complex, routed network:

- If you have programming or other network devices that use an on-board adapter card connected to your plant LAN or an Ethernet-to-USB adapter card connected to an isolated network, you must assign IP addresses to them. Refer to "Assigning IP addresses to programming and network devices" (Page 155) for more information.
- You can also assign an IP address to a CPU or network device online. This is particularly useful in an initial device configuration. Refer to "Assigning an IP address to a CPU online" (Page 155) for more information.
- After you have configured your CPU or network device in your project, you can configure parameters for the PROFINET interface, to include its IP address. Refer to "Configuring an IP address for a CPU in your project" (Page 158) for more information.

10.2.3.4 Testing your PROFINET network

After completing the configuration, you must download your project to the CPU. All IP addresses are configured when you download the project.

The CPU "Download to device" function and its "Extended download to device" dialog can show all accessible network devices and whether or not unique IP addresses have been assigned to all devices. Refer to "Testing the PROFINET network" (Page 162) for more information.

10.2.4 HMI-to-PLC communication



The CPU supports PROFINET communications connections to HMIs (Page 32). The following requirements must be considered when setting up communications between CPUs and HMIs:

Configuration/Setup:

- The PROFINET port of the CPU must be configured to connect with the HMI.
- The HMI must be setup and configured.
- The HMI configuration information is part of the CPU project and can be configured and downloaded from within the project.
- No Ethernet switch is required for one-to-one communications; an Ethernet switch is required for more than two devices in a network.

Note

The rack-mounted CSM1277 4-port Ethernet switch can be used to connect your CPUs and HMI devices. The PROFINET port on the CPU does not contain an Ethernet switching device.

Supported functions:

- The HMI can read/write data to the CPU.
- Messages can be triggered, based upon information retrieved from the CPU.
- System diagnostics

Table 10- 24 Required steps in configuring communications between an HMI and a CPU

| Step | Task |
|------|---|
| 1 | Establishing the hardware communications connection A PROFINET interface establishes the physical connection between an HMI and a CPU. Since Auto-Cross-Over functionality is built into the CPU, you can use either a standard or crossover Ethernet cable for the interface. An Ethernet switch is not required to connect an HMI and a CPU. Refer to "Communication with a programming device: Establishing the hardware communications connection" (Page 550) for more information. |
| 2 | Configuring the devices Refer to "Communication with a programming device: Configuring the devices" (Page 551) for more information. |
| 3 | Configuring the logical network connections between an HMI and a CPU Refer to "HMI-to-PLC communication: Configuring the logical network connections between two devices" (Page 553) for more information. |

| Step | Task |
|------|--|
| 4 | Configuring an IP address in your project Use the same configuration process; however, you must configure IP addresses for the HMI and the CPU. Refer to "Device configuration: Configuring an IP address for a CPU in your project" (Page 159) for more information. |
| 5 | Testing the PROFINET network You must download the configuration for each CPU and HMI device. Refer to "Device configuration: Testing the PROFINET network" (Page 162) for more information. |

10.2.4.1 Configuring logical network connections between two devices

After you configure the rack with the CPU, you are now ready to configure your network connections.

In the Devices and Networks portal, use the "Network view" to create the network connections between the devices in your project. First, click the "Connections" tab, and then select the connection type with the dropdown, just to the right (for example, an ISO on TCP connection).

To create a PROFINET connection, click the green (PROFINET) box on the first device, and drag a line to the PROFINET box on the second device. Release the mouse button and your PROFINET connection is joined.

Refer to "Device Configuration: Creating a network connection" (Page 149) for more information.

10.2.5 PLC-to-PLC communication



A CPU can communicate with another CPU on a network by using the TSEND_C and TRCV_C instructions.

Consider the following when setting up communications between two CPUs:

- Configuration/Setup: Hardware configuration is required.
- Supported functions: Reading/Writing data to a peer CPU
- No Ethernet switch is required for one-to-one communications; an Ethernet switch is required for more than two devices in a network.

Table 10- 25 Required steps in configuring communications between two CPUs

| Step | Task |
|------|--|
| 1 | <p>Establishing the hardware communications connection</p> <p>A PROFINET interface establishes the physical connection between two CPUs. Since Auto-Cross-Over functionality is built into the CPU, you can use either a standard or crossover Ethernet cable for the interface. An Ethernet switch is not required to connect the two CPUs.</p> <p>Refer to "Communication with a programming device: Establishing the hardware communications connection" (Page 550) for more information.</p> |
| 2 | <p>Configuring the devices</p> <p>You must configure two CPUs in your project.</p> <p>Refer to "Communication with a programming device: Configuring the devices" (Page 551) for more information.</p> |
| 3 | <p>Configuring the logical network connections between two CPUs</p> <p>Refer to "PLC-to-PLC communication: Configuring logical network connections between two devices" (Page 554) for more information.</p> |
| 4 | <p>Configuring an IP address in your project</p> <p>Use the same configuration process; however, you must configure IP addresses for two CPUs (for example, PLC_1 and PLC_2).</p> <p>Refer to "Device configuration: Configuring an IP address for a CPU in your project" (Page 159) for more information.</p> |
| 5 | <p>Configuring transmit (send) and receive parameters</p> <p>You must configure TSEND_C and TRCV_C instructions in both CPUs to enable communications between them.</p> <p>Refer to "Configuring communications between two CPUs: Configuring transmit (send) and receive parameters" (Page 555) for more information.</p> |
| 6 | <p>Testing the PROFINET network</p> <p>You must download the configuration for each CPU.</p> <p>Refer to "Device configuration: Testing the PROFINET network" (Page 162) for more information.</p> |

10.2.5.1 Configuring logical network connections between two devices

After you configure the rack with the CPU, you are now ready to configure your network connections.

In the Devices and Networks portal, use the "Network view" to create the network connections between the devices in your project. First, click the "Connections" tab, and then select the connection type with the dropdown, just to the right (for example, an ISO on TCP connection).

To create a PROFINET connection, click the green (PROFINET) box on the first device, and drag a line to the PROFINET box on the second device. Release the mouse button and your PROFINET connection is joined.

Refer to "Device Configuration: Creating a network connection" (Page 149) for more information.

10.2.5.2 Configuring the Local/Partner connection path between two devices

Configuring General parameters

You specify the communication parameters in the "Properties" configuration dialog of the communication instruction. This dialog appears near the bottom of the page whenever you have selected any part of the instruction.

Refer to "Device configuration: Configuring the Local/Partner connection path (Page 150)" for more information.

In the "Address Details" section of the Connection parameters dialog, you define the TSAPs or ports to be used. The TSAP or port of a connection in the CPU is entered in the "Local TSAP" field. The TSAP or port assigned for the connection in your partner CPU is entered under the "Partner TSAP" field.

10.2.5.3 Configuring transmit (send) and receive parameters

Communication blocks (for example, TSEND_C and TRCV_C) are used to establish connections between two CPUs. Before the CPUs can engage in PROFINET communications, you must configure parameters for transmitting (or sending) messages and receiving messages. These parameters dictate how communications operate when messages are being transmitted to or received from a target device.

Configuring the TSEND_C instruction transmit (send) parameters

TSEND_C instruction

The TSEND_C instruction (Page 520) creates a communications connection to a partner station. The connection is set up, established, and automatically monitored until it is commanded to disconnect by the instruction. The TSEND_C instruction combines the functions of the TCON, TDISCON and TSEND instructions.

From the Device configuration in STEP 7, you can configure how a TSEND_C instruction transmits data. To begin, you insert the instruction into the program from the "Communications" folder in the "Instructions" task card. The TSEND_C instruction is displayed, along with the Call options dialog where you assign a DB for storing the parameters of the instruction.

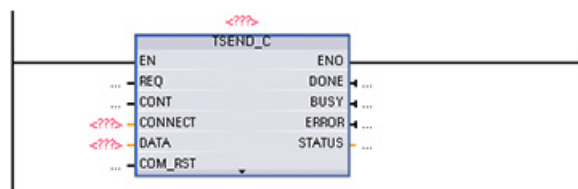

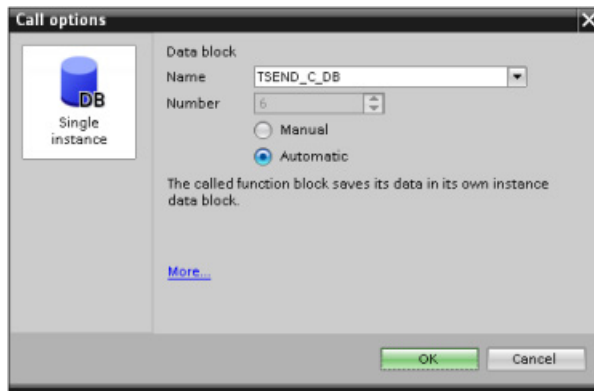

You can assign tag memory locations to the inputs and outputs, as shown in the following figure:

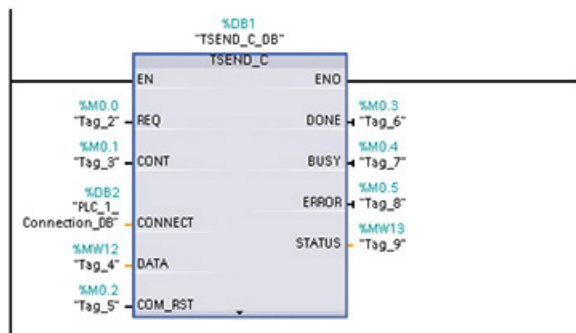

Configuring General parameters

You specify the parameters in the Properties configuration dialog of the TSEND_C instruction. This dialog appears near the bottom of the page whenever you have selected any part of the TSEND_C instruction.

Configuring the TRCV_C instruction receive parameters

TRCV_C instruction

The TRCV_C instruction (Page 520) creates a communications connection to a partner station. The connection is set up, established, and automatically monitored until it is commanded to disconnect by the instruction. The TRCV_C instruction combines the functions of the TCON, TDISCON, and TRCV instructions.

From the CPU configuration in STEP 7, you can configure how a TRCV_C instruction receives data. To begin, insert the instruction into the program from the "Communications" folder in the "Instructions" task card. The TRCV_C instruction is displayed, along with the Call options dialog where you assign a DB for storing the parameters of the instruction.

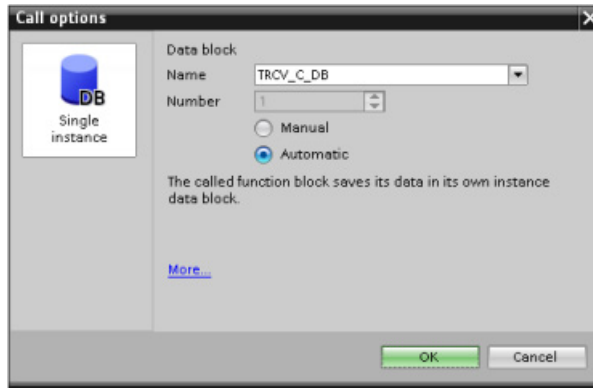
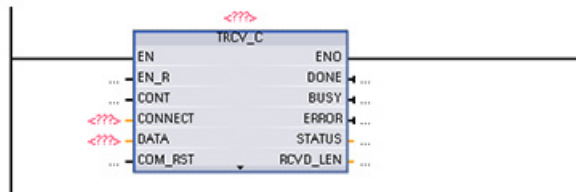

You can assign tag memory locations to the inputs and outputs, as shown in the following figure:

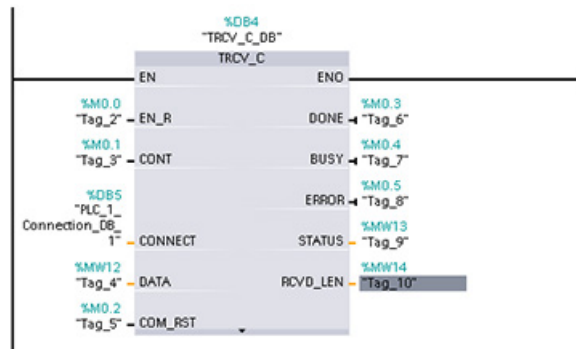

Configuring the General parameters

You specify the parameters in the Properties configuration dialog of the TRCV_C instruction. This dialog appears near the bottom of the page whenever you have selected any part of the TRCV_C instruction.

10.2.6 Configuring a CPU and PROFINET IO device

10.2.6.1 Adding a PROFINET IO device

Adding a PROFINET IO device



In the "Devices and networks" portal, use the hardware catalog to add PROFINET IO devices.

Note

To add a PROFINET IO device, you can use STEP 7 Professional or Basic, V11 or greater.

For example, expand the following containers in the hardware catalog to add an ET200S IO device: Distributed I/O, ET200S, Interface modules, and PROFINET. You can then select the interface module from the list of ET200S devices (sorted by part number) and add the ET200S IO device.

Table 10- 26 Adding an ET200S IO device to the device configuration

| Insert the IO device | Result |
|---|--|
|  |  |

You can now connect the PROFINET IO device to the CPU:

1. Right-click the "Not assigned" link on the device and select "Assign new IO controller" from the context menu to display the "Select IO controller" dialog.
2. Select your S7-1200 CPU (in this example, "PLC_1") from the list of IO controllers in the project.
3. Click "OK" to create the network connection.

10.2.6.2 Configuring logical network connections between a CPU and a PROFINET IO device

Configuring logical network connections

After you configure the rack with the CPU, you are now ready to configure your network connections.

In the "Devices and networks" portal, use the "Network view" to create the network connections between the devices in your project. To create a PROFINET connection, click the green (PROFINET) box on the first device, and drag a line to the PROFINET box on the second device. Release the mouse button and your PROFINET connection is joined.

Refer to "Device Configuration: Creating a network connection" (Page 149) for more information.

10.2.6.3 Assigning CPUs and device names

Assigning CPUs and device names

Network connections between the devices also assign the PROFINET IO device to the CPU, which is required for that CPU to control the device. To change this assignment, click the PLC Name shown on the PROFINET IO device. A dialog box opens that allows the PROFINET IO device to be disconnected from the current CPU and reassigned or left unassigned, if desired.

The devices on your PROFINET network must have an assigned name before you can connect with the CPU. Use the "Network view" to assign names to your PROFINET devices if the devices have not already been assigned a name or if the name of the device is to be changed. Right-click the PROFINET IO device and select "Assign device name" to do this.

For each PROFINET IO device, you must assign the same name to that device in both the STEP 7 project and, using the "Online & diagnostics" tool, to the PROFINET IO device configuration memory (for example, an ET200 S interface module configuration memory). If a name is missing or does not match in either location, the PROFINET IO data exchange mode will not run. Refer to "Online and diagnostic tools: Assigning a name to a PROFINET device online (Page 787)" for more information.

10.2.6.4 Assigning Internet Protocol (IP) addresses

Assigning the IP addresses

In a PROFINET network, each device must also have an Internet Protocol (IP) address. This address allows the device to deliver data on a more complex, routed network:

- If you have programming or other network devices that use an on-board adapter card connected to your plant LAN or an Ethernet-to-USB adapter card connected to an isolated network, you must assign IP addresses to them. Refer to "Assigning IP addresses to programming and network devices" (Page 155) for more information.
- You can also assign an IP address to a CPU or network device online. This is particularly useful in an initial device configuration. Refer to "Assigning an IP address to a CPU online" (Page 158) for more information.
- After you have configured your CPU or network device in your project, you can configure parameters for the PROFINET interface, to include its IP address. Refer to "Configuring an IP address for a CPU in your project" (Page 159) for more information.

10.2.6.5 Configuring the IO cycle time

Configuring the IO cycle time

A PROFINET IO device is supplied with new data from the CPU within an "IO cycle" time period. The update time can be separately configured for each device and determines the time interval in which data is transmitted from the CPU to and from the device.

STEP 7 calculates the "IO cycle" update time automatically in the default setting for each device of the PROFINET network, taking into account the volume of data to be exchanged and the number of devices assigned to this controller. If you do not want to have the update time calculated automatically, you can change this setting.

You specify the "IO cycle" parameters in the "Properties" configuration dialog of the PROFINET IO device. This dialog appears near the bottom of the page whenever you have selected any part of the instruction.

In the "Device view" of the PROFINET IO device, click the PROFINET port. In the "PROFINET Interface" dialog, access the "IO cycle" parameters with the following menu selections:

- "Advanced options"
- "Realtime settings"
- "IO cycle"

Define the IO cycle "Update time" with the following selections:

- To have a suitable update time calculated automatically, select "Automatic".
- To set the update yourself, select "Can be set" and enter the required update time in ms.
- To ensure consistency between the send clock and the update time, activate the "Adapt update time when send clock changes" option. This option ensures that the update time is not set to less than the send clock.

Table 10- 27 Configuring the ET200S PROFINET IO cycle time

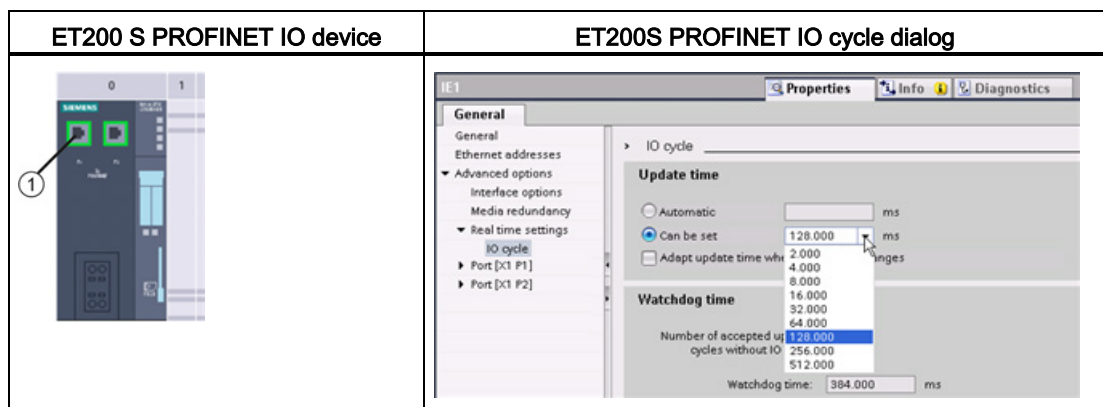

① PROFINET port

10.2.7 Configuring a CPU and PROFINET iDevice

10.2.7.1 I-device functionality

The "I-device" (intelligent IO device) functionality of a CPU facilitates data exchange with an IO controller and operation of the CPU as intelligent preprocessing unit of sub processes, for example. The I-device is linked as an IO device to a "higher-level" IO controller.

The pre-processing is handled by the user program on the CPU. The process values acquired in the centralized or distributed (PROFINET IO or PROFIBUS DP) I/O are pre-processed by the user program and made available through a PROFINET IO interface to the CPU of a higher-level station.

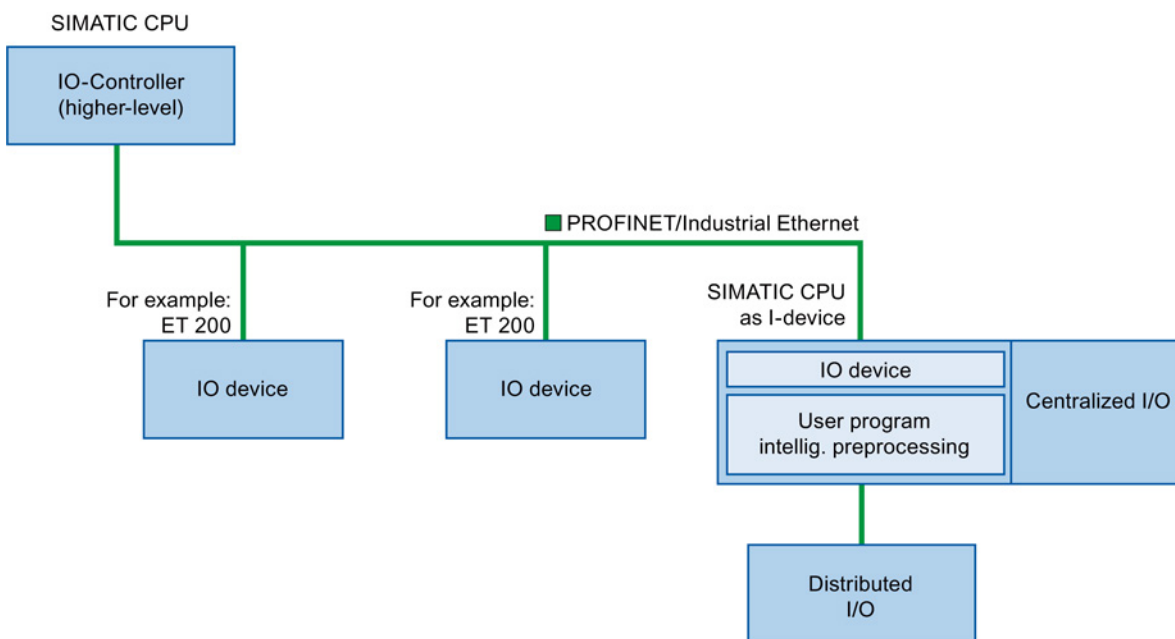

"I-device" naming conventions

In the remainder of this description, a CPU or a CP with I-device functionality is simply called an "I-device".

10.2.7.2 Properties and advantages of the I-device

Fields of application

Fields of application of the I-device:

- Distributed processing:

A complex automation task can be divided into smaller units/subprocesses. This results in manageable processes which lead to simplified subtasks.

- Separating subprocesses:

Complicated, widely distributed and extensive processes can be subdivided into several subprocesses with manageable interfaces by using I-devices. These subprocesses can be stored in individual STEP 7 projects if necessary, which can later be merged to form one master project.

- Know-how protection:

Components can only be delivered with a GSD file for the I-device interface description instead of with a STEP 7 project. The user can protect his program since it no longer has to be published.

Properties

Properties of the I-device:

- Unlinking STEP 7 projects:

Creators and users of an I-device can have completely separated STEP 7 automation projects. The GSD file forms the interface between the STEP 7 projects. This allows a link to standard IO controllers through a standardized interface.

- Real-time communication:

The I-device is provided with a deterministic PROFINET IO system through a PROFINET IO interface and therefore supports RT (real-time communication) and IRT (isochronous real time).

Advantages

The I-device has the following advantages:

- Simple linking of IO controllers
- Real-time communication between IO controllers
- Relieving the IO controller by distributing the computing capacity to I-devices.
- Lower communications load by processing process data locally.
- Manageable, due to processing of subtasks in separate STEP 7 projects

10.2.7.3 Characteristics of an I-device

An I-device is included in an IO system like a standard IO device.

I-device without lower-level PROFINET IO system

The I-device does not have its own distributed I/O. The configuration and parameter assignment of the I-devices in the role of an IO device is the same as for a distributed I/O system (for example, ET 200).

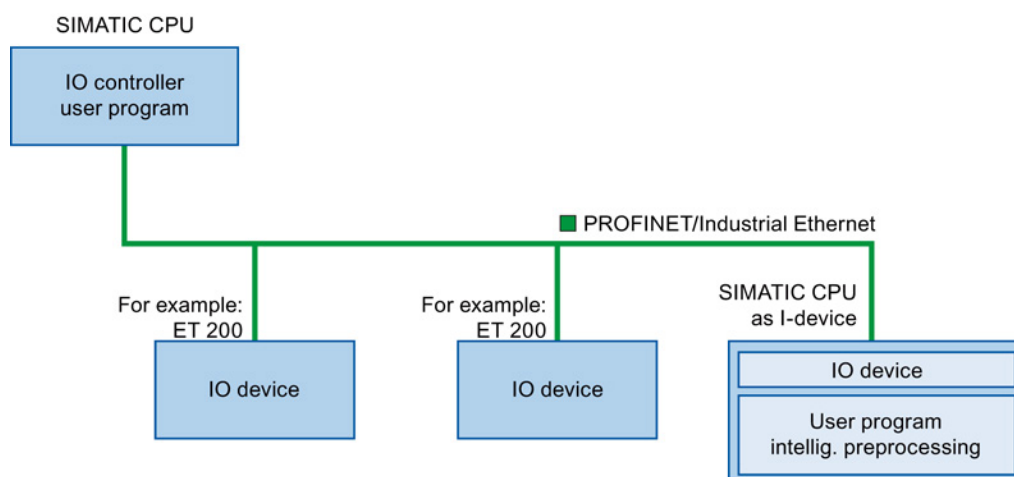

I-device with lower-level PROFINET IO system

Depending on the configuration, an I-device can also be an IO controller on a PROFINET interface in addition to having the role of an IO device.

This means that the I-device can be part of a higher-level IO system through its PROFINET interface and as an IO controller can support its own lower-level IO system.

The lower-level IO system can, in turn, contain I-devices (see figure below). This makes hierarchically structured IO systems possible.

In addition to its role as IO controller, an I-device can also be used through a PROFIBUS interface as DP master for a lower-level PROFIBUS system.

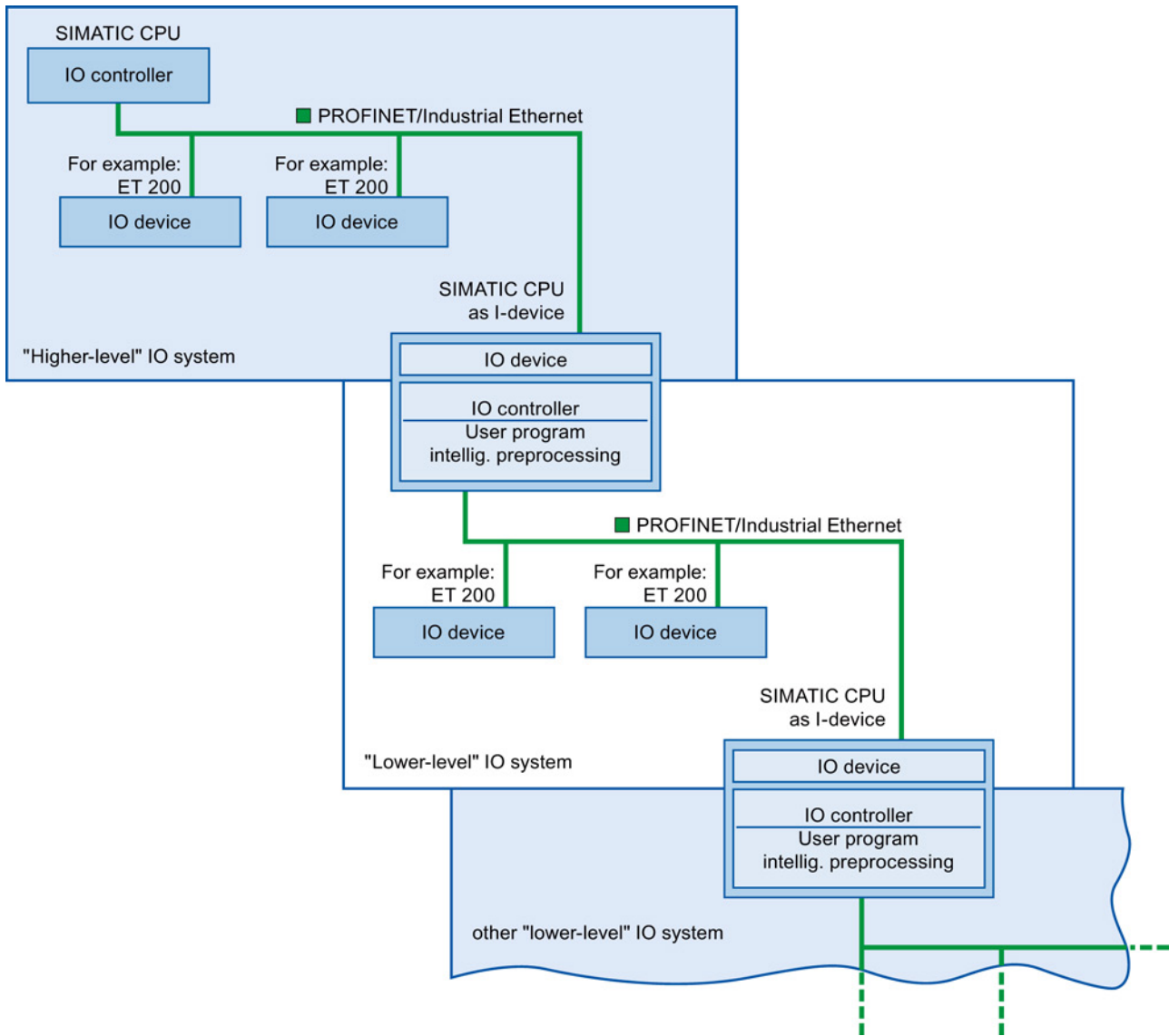

Example - the I-device as IO device and IO controller

The I-device as IO device and IO controller is explained based on the example of a print process. The I-device controls a unit (a subprocess). One unit is used, for example, to insert additional sheets such as flyers or brochures in a package of printed material.

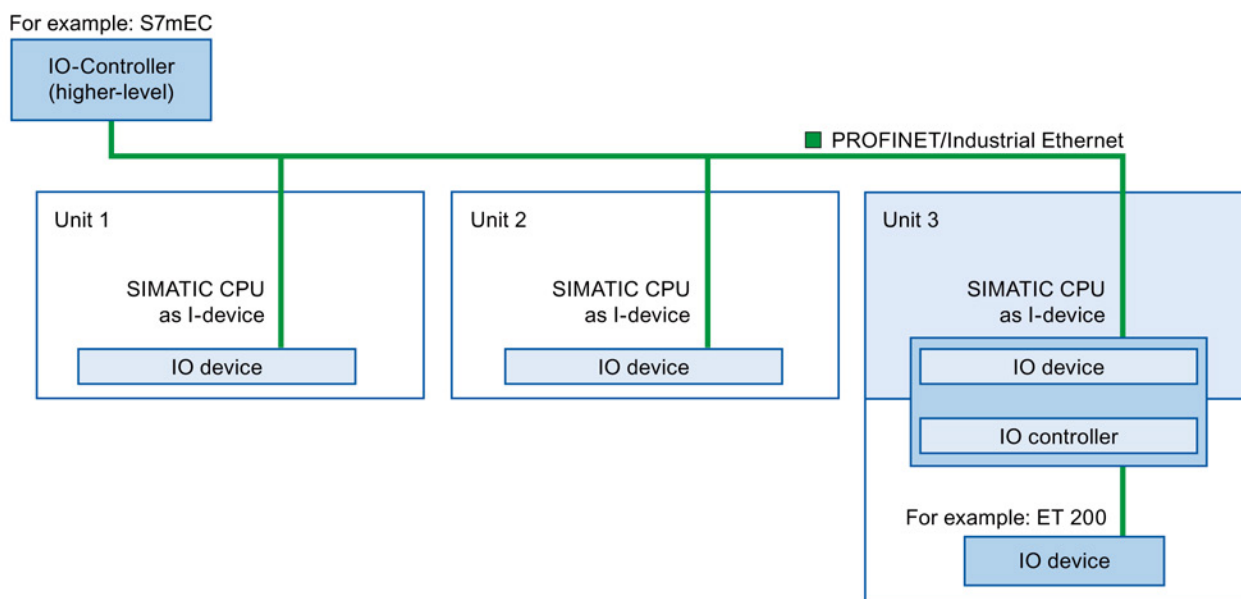

Unit 1 and unit 2 each consist of an I-device with centralized I/O. The I-device along with the distributed I/O system (for example, ET 200) forms unit 3.

The user program on the I-device is responsible for preprocessing the process data. For this task, the user program of the I-device requires default settings (for example, control data) from the higher-level IO controller. The I-device provides the higher-level IO controller with the results (for example, status of its subtask).

10.2.7.4 Data exchange between higher- and lower-level IO system

Transfer areas are an interface to the user program of the I-device CPU. Inputs are processed in the user program and outputs are the result of the processing in the user program.

The data for communication between IO controller and I-device is made available in the transfer areas. A transfer area contains an information unit that is exchanged consistently between IO controller and I-device. You can find more information on configuration and use of transfer areas in the section "Configuring the I-device".

The next figure shows the data exchange between the higher- and lower-level IO system. The individual communication relations are explained below based upon the numbers:

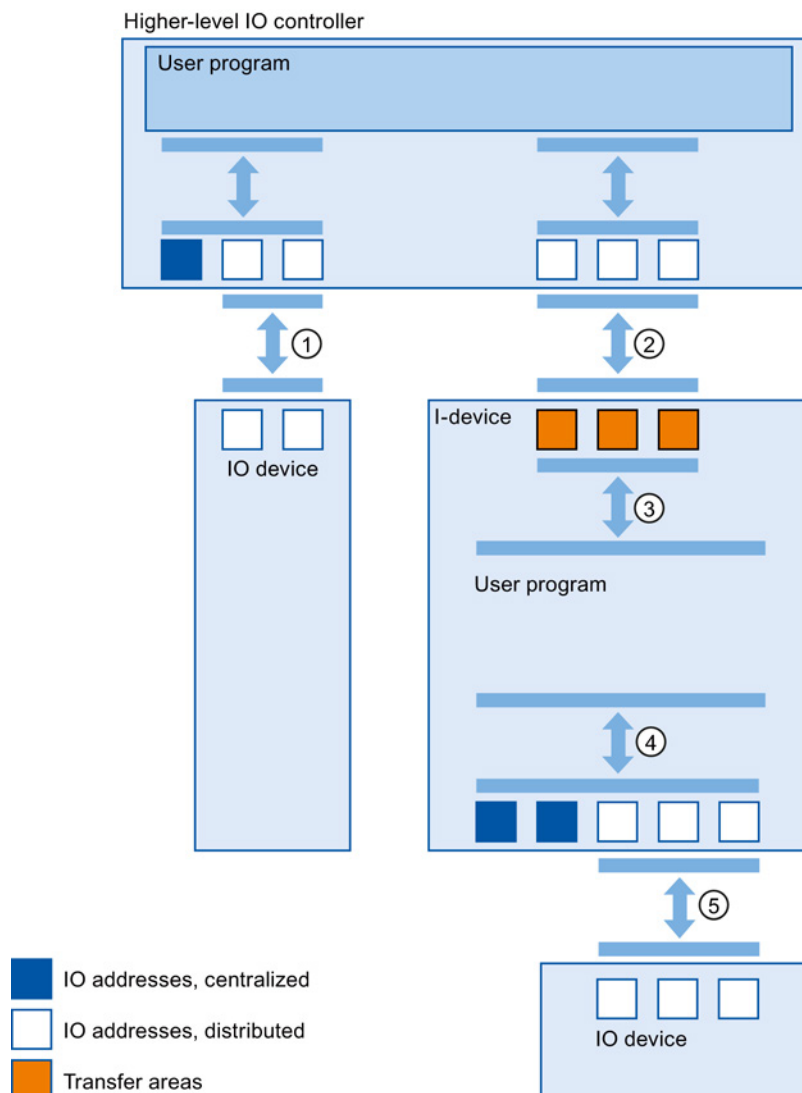

- IO addresses, centralized
- IO addresses, distributed
- Transfer areas

- ① **Data exchange between higher-level IO controller and normal IO-device**
In this way, the IO controller and IO devices exchange data through PROFINET.
- ② **Data exchange between higher-level IO controller and I-device**
In this way, the IO controller and the I-device exchange data through PROFINET.
The data exchange between a higher-level IO controller and an I-device is based upon the conventional IO controller / IO device relationship.
For the higher-level IO controller, the transfer areas of the I-devices represent submodules of a pre-configured station.
The output data of the IO controller is the input data of the I-device. Analogously, the input data of the IO controller is the output data of the I-device.
- ③ **Transfer relationship between the user program and the transfer area**
In this way, the user program and the transfer area exchange input and output data.
- ④ **Data exchange between the user program and the I/O of the I-device**
In this way, the user program and the centralized / distributed I/O exchange input and output data.

⑤ **Data exchange between the I-device and a lower-level IO device**

In this way, the I-device and its IO devices exchange data. The data transfer is through PROFINET.

10.2.7.5 Configuring the I-device

There are basically two possibilities for configuration:

- Configuration of an I-device within a project
- Configuration of an I-device that is used in another project or in another engineering system.

STEP 7 allows you to configure an I-device for another project or for another engineering system by exporting a configured iDevice to a GSD file. You import the GSD file in other projects or engineering systems as with other GSD files. The transfer areas for the data exchange, among other data, are stored in this GSD file.

Configuration of an I-device within a project

1. Drag-and-drop a PROFINET CPU from the hardware catalog into the network view.
2. Drag-and-drop a PROFINET CPU, which can also be configured as an IO device, from the hardware catalog into the network view. This device is configured as an I-device (for example, CPU 1215C).
3. Select the PROFINET interface for the I-device.
4. In the Inspector window in the area navigation choose "Operating mode" and select the check box "IO device".
5. Now you have the option of choosing the IO controller in the "Assigned IO controller" drop-down list.

Once you have chosen the IO controller, the networking and the IO system between both devices are displayed in the network view.

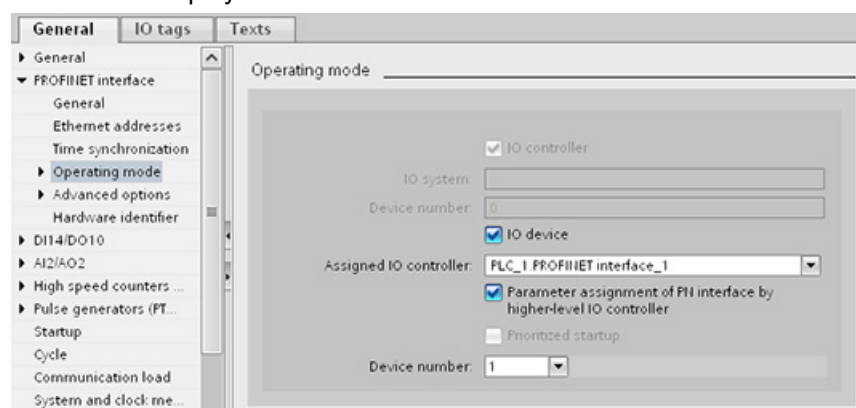

6. With the "Parameter assignment of PN interface by higher-level IO controller" check box, you specify whether the interface parameters will be assigned by the I-device itself or by a higher-level IO controller.

If you operate the I-device with a lower-level IO system, then the parameters of the I-device PROFINET interface (for example, port parameter) cannot be assigned with the higher-level IO controller.

7. Configure the transfer areas. The transfer areas are found in the area navigation section "I-device communication":
 - Click in the first field of the "Transfer area" column. STEP 7 assigns a default name which you can change.
 - Select the type of communication relation: you can currently only select CD or F-CD.
 - Addresses are automatically preset; you can correct addresses if necessary, and determine the length of the transfer area which is to be consistently transferred.

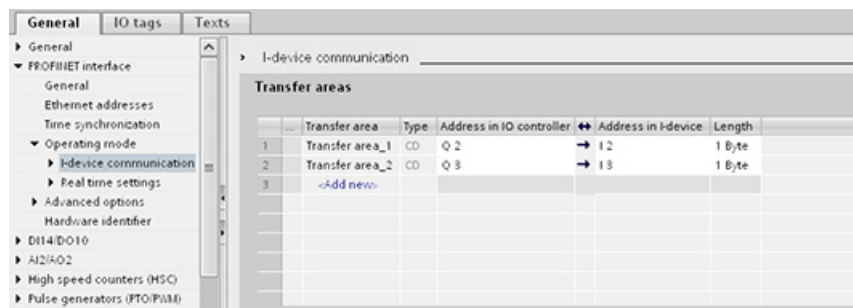

8. A separate entry is created in the area navigation for each transfer area. If you select one of these entries, you can adjust the details of the transfer area, or correct them and comment on them.

Configuring an I-device with a GSD file

If you use an I-device in another project, or if the I-device is used in another engineering system, then configure the higher-level IO controller and the I-device as described above.

However, click on the "Export" button after configuring the transfer areas so a new GSD file is created from the I-device. This GSD file represents the configured I-device in other projects.

The "Export" button is found in the "I-device communication" section of the Inspector window.

The hardware configuration is compiled and the export dialog opened.

Assign a name for the I-device proxy as well as a description in the fields provided. Click the "Export" button to complete your process.

Finally, import the GSD file, for example, in another project.

10.2.8 Diagnostics

Refer to "Organization blocks (OBs)" (Page 85) for information on how to use organization blocks (OBs) for diagnostics with these communication networks.

10.2.9 Distributed I/O instructions

Refer to "Distributed I/O (PROFINET, PROFIBUS, or AS-i)" (Page 314) for information on how to use the distributed I/O instructions with these communication networks.

10.2.10 Diagnostic instructions

Refer to the "Diagnostics (PROFINET or PROFIBUS)": "Diagnostics instructions" (Page 345) for information on how to use these instructions with these communication networks.

10.2.11 Diagnostic events for distributed I/O

Refer to the "Diagnostics (PROFINET or PROFIBUS)": "Diagnostics events for distributed I/O" (Page 345) for information on how to use this diagnostic information with these communication networks.

10.3 PROFIBUS

A PROFIBUS system uses a bus master to poll slave devices distributed in a multi-drop fashion on an RS485 serial bus. A PROFIBUS slave is any peripheral device (I/O transducer, valve, motor drive, or other measuring device) which processes information and sends its output to the master. The slave forms a passive station on the network since it does not have bus access rights, and can only acknowledge received messages, or send response messages to the master upon request. All PROFIBUS slaves have the same priority, and all network communication originates from the master.

A PROFIBUS master forms an "active station" on the network. PROFIBUS DP defines two classes of masters. A class 1 master (normally a central programmable controller (PLC) or a PC running special software) handles the normal communication or exchange of data with the slaves assigned to it. A class 2 master (usually a configuration device, such as a laptop or programming console used for commissioning, maintenance, or diagnostics purposes) is a special device primarily used for commissioning slaves and for diagnostic purposes.

The S7-1200 is connected to a PROFIBUS network as a DP slave with the CM 1242-5 communication module. The CM 1242-5 (DP slave) module can be the communications partner of DP V0/V1 masters. If you want to configure the module in a third-party system, there is a GSD file available for the CM 1242-5 (DP slave) on the CD that ships with the module and on Siemens Automation Customer Support (<http://support.automation.siemens.com/WW/llisapi.dll?func=cslib.csinfo&lang=en&objid=6GK72425DX300XE0&caller=view>) pages on the Internet.

In the figure below, the S7-1200 is a DP slave to an S7-300 controller:

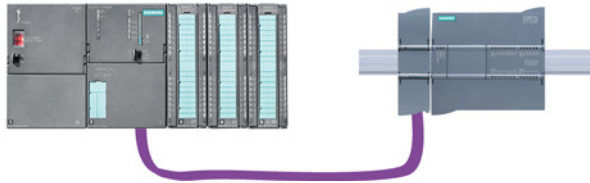

The S7-1200 is connected to a PROFIBUS network as a DP master with the CM 1243-5 communication module. The CM 1243-5 (DP master) module can be the communications partner of DP V0/V1 slaves. In the figure below, the S7-1200 is a master controlling an ET200S DP slave:

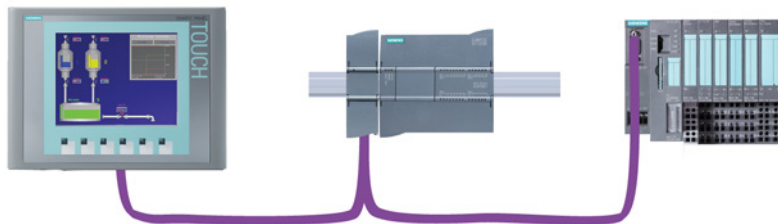

If a CM 1242-5 and a CM 1243-5 are installed together, an S7-1200 can perform as both a slave of a higher-level DP master system and a master of a lower-level DP slave system, simultaneously:



For V4.0, you can configure a maximum of three PROFIBUS CMs per station, in which there can be any combination of DP master or DP slave CMs. DP masters in a V3.0 or greater CPU firmware implementation can each control a maximum of 32 slaves.

The configuration data of the PROFIBUS CMs is stored on the local CPU. This allows simple replacement of these communications modules when necessary.

To use PROFIBUS with S7-1200 V4.0 CPUs, you must upgrade the PROFIBUS Master CM firmware to V1.3.

You can make this upgrade using a Secure Digital (SD) card.

Note

It is recommended that you always update the PROFIBUS CM firmware to the latest version available (<http://support.automation.siemens.com/WW/view/en/42131407>) at the Siemens Service and Support web site.

10.3.1 Communications services of the PROFIBUS CMs

The PROFIBUS CMs use the PROFIBUS DP-V1 protocol.

Types of communication with DP-V1

The following types of communication are available with DP-V1:

- Cyclic communication (CM 1242-5 and CM 1243-5)

Both PROFIBUS modules support cyclic communication for the transfer of process data between DP slave and DP master.

Cyclic communication is handled by the operating system of the CPU. No software blocks are required for this. The I/O data is read or written directly from/to the process image of the CPU.

- Acyclic communication (CM 1243-5 only)

The DP master module also supports acyclic communication using software blocks:

- The "RALRM" instruction is available for interrupt handling.
- The "RDREC" and "WRREC" instructions are available for transferring configuration and diagnostics data.

Functions not supported by the CM 1243-5: SYNC/FREEZE and Get_Master_Diag

Other communications services of the CM 1243-5

The CM 1243-5 DP master module supports the following additional communications services:

- S7 communication

- PUT/GET services

The DP master functions as a client and server for queries from other S7 controllers or PCs via PROFIBUS.

- PG/OP communication

The PG functions allow the downloading of configuration data and user programs from a PG and the transfer of diagnostics data to a PG.

Possible communications partners for OP communication are HMI panels, SIMATIC panel PCs with WinCC flexible or SCADA systems that support S7 communication.

10.3.2 Reference to the PROFIBUS CM user manuals

Further information

You can find detailed information on the PROFIBUS CMs in the manuals for the devices. You can find these on the Internet in the pages of Siemens Industrial Automation Customer Support under the following entry IDs:

- CM 1242-5 (<http://support.automation.siemens.com/WW/view/en/49852105>)
- CM 1243-5 (<http://support.automation.siemens.com/WW/view/en/49851842>)

10.3.3 Configuring a DP master and slave device

10.3.3.1 Adding the CM 1243-5 (DP master) module and a DP slave

In the "Devices and networks" portal, use the hardware catalog to add PROFIBUS modules to the CPU. These modules are connected to the left side of the CPU. To insert a module into the hardware configuration, select the module in the hardware catalog and either double-click or drag the module to the highlighted slot.

Table 10- 28 Adding a PROFIBUS CM 1243-5 (DP master) module to the device configuration

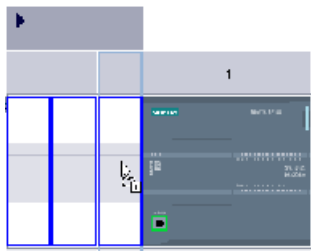
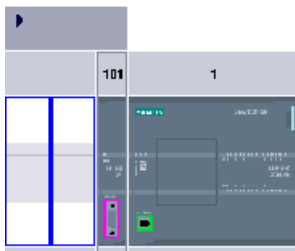

| Module | Select the module | Insert the module | Result |
|-----------------------|---|---|---|
| CM 1243-5 (DP master) |  |  |  |

Use the hardware catalog to add DP slaves as well. For example, to add an ET200 S DP slave, in the Hardware Catalog, expand the following containers:

- Distributed I/O
- ET200 S
- Interface modules
- PROFIBUS

Next, select "6ES7 151-1BA02-0AB0" (IM151-1 HF) from the list of part numbers, and add the ET200 S DP slave as shown in the figure below.

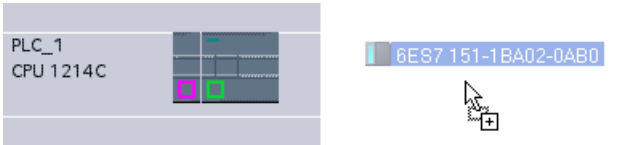
Table 10- 29 Adding an ET200 S DP slave to the device configuration

| Insert the DP slave | Result |
|---|--|
|  |  |

10.3.3.2 Configuring logical network connections between two PROFIBUS devices

After you configure the CM 1243-5 (DP master) module, you are now ready to configure your network connections.

In the Devices and Networks portal, use the "Network view" to create the network connections between the devices in your project. To create the PROFIBUS connection, select the purple (PROFIBUS) box on the first device. Drag a line to the PROFIBUS box on the second device. Release the mouse button and your PROFIBUS connection is joined.

Refer to "Device Configuration: Creating a network connection" (Page 149) for more information.

10.3.3.3 Assigning PROFIBUS addresses to the CM 1243-5 module and DP slave

Configuring the PROFIBUS interface

After you configure logical network connections between two PROFIBUS devices, you can configure parameters for the PROFIBUS interfaces. To do so, click the purple PROFIBUS box on the CM 1243-5 module, and the "Properties" tab in the inspector window displays the PROFIBUS interface. The DP slave PROFIBUS interface is configured in the same manner.

Table 10- 30 Configuring the CM 1243-5 (DP master) module and ET200 S DP slave PROFIBUS interfaces

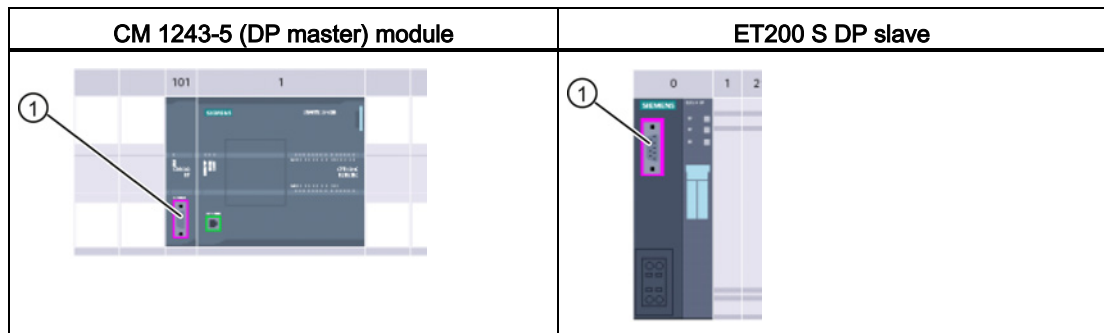

① PROFIBUS port

Assigning the PROFIBUS address

In a PROFIBUS network, each device is assigned a PROFIBUS address. This address can range from 0 through 127, with the following exceptions:

- Address 0: Reserved for network configuration and/or programming tools attached to the bus
- Address 1: Reserved by Siemens for the first master
- Address 126: Reserved for devices from the factory that do not have a switch setting and must be re-addressed through the network
- Address 127: Reserved for broadcast messages to all devices on the network and may not be assigned to operational devices

Thus, the addresses that may be used for PROFIBUS operational devices are 2 through 125.

In the Properties window, select the "PROFIBUS address" configuration entry. STEP 7 displays the PROFIBUS address configuration dialog, which is used to assign the PROFIBUS address of the device.

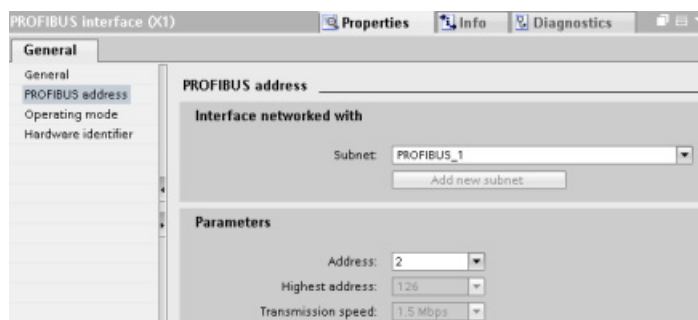

Table 10- 31 Parameters for the PROFIBUS address

| Parameter | | Description |
|------------|-------------------|---|
| Subnet | | Name of the Subnet to which the device is connected. Click the "Add new subnet" button to create a new subnet. "Not connected" is the default. Two connection types are possible: <ul style="list-style-type: none"> • The "Not connected" default provides a local connection. • A subnet is required when your network has two or more devices. |
| Parameters | Address | Assigned PROFIBUS address for the device |
| | Highest address | The highest PROFIBUS address is based on the active stations on the PROFIBUS (for example, DP master). Passive DP slaves independently have PROFIBUS addresses from 1 to 125 even if the highest PROFIBUS address is set to 15, for example. The highest PROFIBUS address is relevant for token forwarding (forwarding of the send rights), and the token is only forwarded to active stations. Specifying the highest PROFIBUS address optimizes the bus. |
| | Transmission rate | Transmission rate of the configured PROFIBUS network: The PROFIBUS transmission rates range from 9.6 Kbits/sec to 12 Mbits/sec. The transmission rate setting depends on the properties of the PROFIBUS nodes being used. The transmission rate should not be greater than the rate supported by the slowest node. The transmission rate is normally set for the master on the PROFIBUS network, with all DP slaves automatically using that same transmission rate (auto-baud). |

10.3.4 Distributed I/O instructions

Refer to "Distributed I/O (PROFINET, PROFIBUS, or AS-i)" (Page 314) for information on how to use the distributed I/O instructions with these communication networks.

10.3.5 Diagnostic instructions

Refer to the "Diagnostics (PROFINET or PROFIBUS)": "Diagnostics instructions" (Page 345) for information on how to use these instructions with these communication networks.

10.3.6 Diagnostic events for distributed

Refer to the "Diagnostics (PROFINET or PROFIBUS)": "Diagnostics events for distributed I/O" (Page 345) for information on how to use this diagnostic information with these communication networks.

10.4 AS-i

The S7-1200 AS-i master CM 1243-2 allows the attachment of an AS-i network to an S7-1200 CPU.

The actuator/sensor interface, or AS-i, is a single master network connection system for the lowest level in automation systems. The CM 1243-2 serves as the AS-i master for the network. Using a single AS-i cable, sensors and actuators (AS-i slave devices) can be connected to the CPU through the CM 1243-2. The CM 1243-2 handles all AS-i network coordination and relays data and status information from the actuators and sensors to the CPU through the I/O addresses assigned to the CM 1243-2. You can access binary or analog values depending on the slave type. The AS-i slaves are the input and output channels of the AS-i system and are only active when called by the CM 1243-2.

In the figure below, the S7-1200 is an AS-i master controlling AS-i operator panel and I/O module digital/analog slave devices.

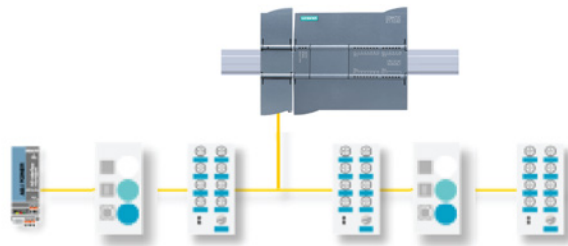

To use AS-i with S7-1200 V4.0 CPUs, you must upgrade the AS-i Master CM firmware to V1.1.

You can make this upgrade using a Secure Digital (SD) card.

Note

It is recommended that you always update the AS-i CM firmware to the latest version available (<http://support.automation.siemens.com/WW/view/en/43416171>) at the Siemens Service and Support web site.

10.4.1 Configuring an AS-i master and slave device

The AS-i master CM 1243-2 is integrated into the S7-1200 automation system as a communication module.

You can find detailed information on the AS-i master CM 1243-2 in the "AS-i master CM 1243-2 and AS-i data decoupling unit DCM 1271 for SIMATIC S7-1200" Manual (<http://support.automation.siemens.com/WW/view/en/50414115/133300>).

10.4.1.1 Adding the AS-i master CM 1243-2 and AS-i slave

Use the hardware catalog to add AS-i master CM1243-2 modules to the CPU. These modules are connected to the left side of the CPU, and a maximum of three AS-i master CM1243-2 modules can be used. To insert a module into the hardware configuration, select the module in the hardware catalog and either double-click or drag the module to the highlighted slot.

Table 10- 32 Adding an AS-i master CM1243-2 module to the device configuration

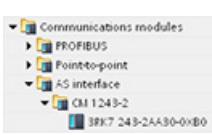
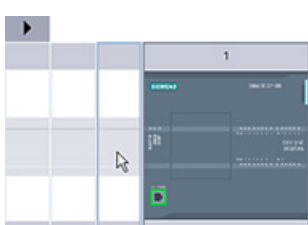
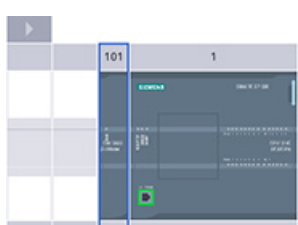

| Module | Select the module | Insert the module | Result |
|-----------------------------|--|--|--|
| CM 1243-2 AS-i Master |  |  |  |

Use the hardware catalog to add AS-i slaves as well. For example, to add an "I/O module, compact, digital, input" slave, in the Hardware Catalog, expand the following containers:

- Field devices
- AS-Interface slaves

Next, select "3RG9 001-0AA00" (AS-i SM-U, 4DI) from the list of part numbers, and add the "I/O module, compact, digital, input" slave as shown in the figure below.

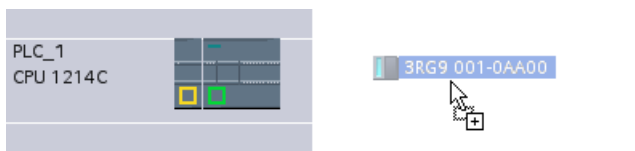
Table 10- 33 Adding an AS-i slave to the device configuration

| Insert the AS-i slave | Result |
|---|--|
|  |  |

10.4.1.2 Configuring logical network connections between two AS-i devices

After you configure the AS-i master CM1243-2, you are now ready to configure your network connections.

In the Devices and Networks portal, use the "Network view" to create the network connections between the devices in your project. To create the AS-i connection, select the yellow (AS-i) box on the first device. Drag a line to the AS-i box on the second device. Release the mouse button and your AS-i connection is joined.

Refer to "Device Configuration: Creating a network connection" (Page 149) for more information.

10.4.1.3 Configuring the properties of the AS-i master CM1243-2

To configure parameters for the AS-i interface, click the yellow AS-i box on the AS-i master CM1243-2 module, and the "Properties" tab in the inspector window displays the AS-i interface.

In the STEP 7 inspector window, you can view, configure, and change general information, addresses and operating parameters:

Table 10- 34 AS-i master CM1243-2 module properties

| Property | Description |
|----------------------|--|
| General | Name of the AS-i master CM 1243-2 |
| Operating parameters | Parameters for the response of the AS-i master |
| I/O addresses | Address area for the slave I/O addresses |
| AS-i interface (X1) | Assigned AS-i network |

Note

"Diagnostic interrupt for faults in the AS-i configuration" and "Automatic address programming" are always active and are therefore shown in gray.

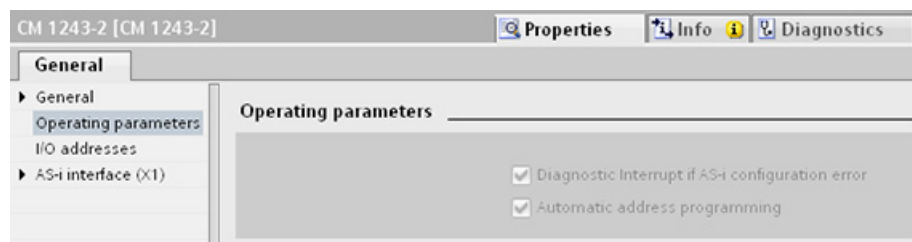

10.4.1.4 Assigning an AS-i address to an AS-i slave

Configuring the AS-i slave interface

To configure parameters for the AS-i interface, click the yellow AS-i box on the AS-i slave, and the "Properties" tab in the inspector window displays the AS-i interface.

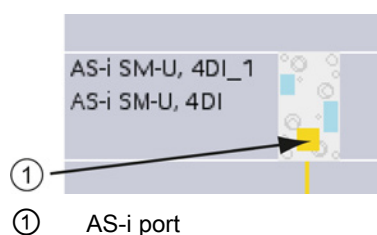

Assigning the AS-i slave address

In an AS-i network, each device is assigned an AS-i slave address. This address can range from 0 through 31; however, address 0 is reserved only for new slave devices. The slave addresses are 1(A or B) to 31(A or B) for a total of up to 62 slave devices.

"Standard" AS-i devices use the entire address, having a number address without the A or B designation. "A/B node" AS-i devices use the A or B portion of each address, enabling each of the 31 addresses to be used twice. The address space range is 1A to 31A plus 1B to 31B.

Any address in the range of 1 - 31 can be assigned to an AS-i slave device; in other words, it does not matter whether the slaves begin with address 21 or whether the first slave is actually given the address 1.

In the example below, three AS-i devices have been addressed as "1" (a standard type device), "2A" (an A/B node type device), and "3" (a standard type device):

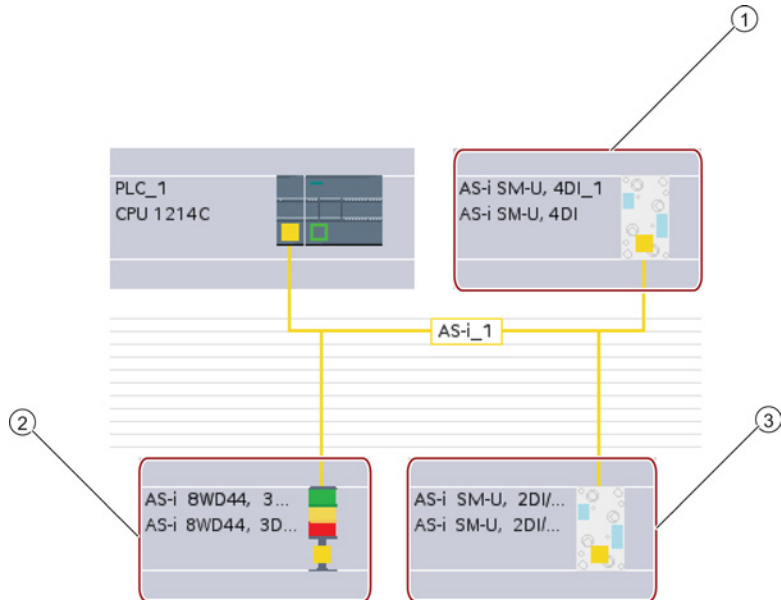

- ① AS-i slave address 1; Device: AS-i SM-U, 4DI; order number: 3RG9 001-0AA00
- ② AS-i slave address 2A; Device: AS-i 8WD44, 3DO, A/B; order number: 8WD4 428-0BD
- ③ AS-i slave address 3; Device: AS-i SM-U, 2DI/2DO; order number: 3RG9 001-0AC00

Enter the AS-i slave address here:

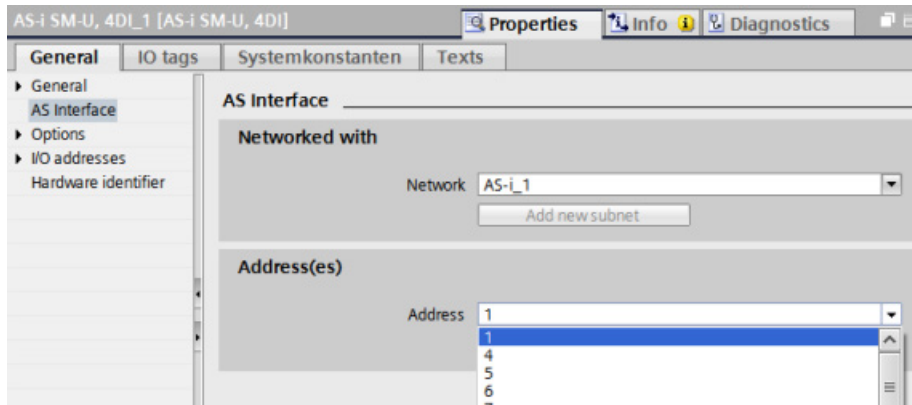

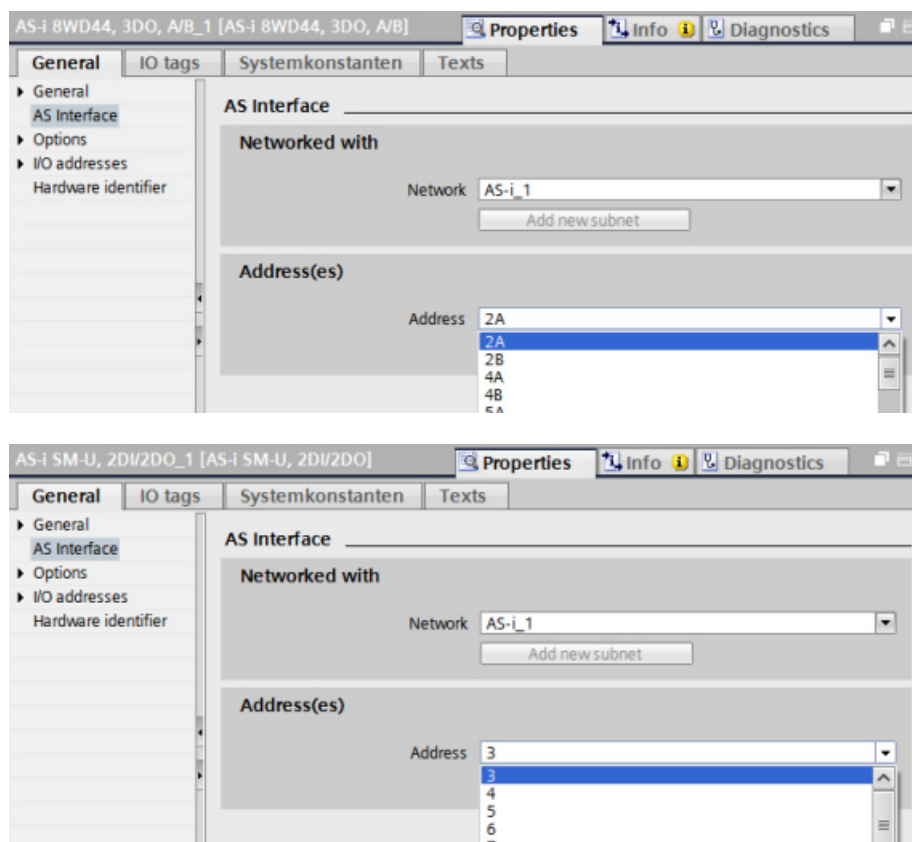

Table 10- 35 Parameters for the AS-i interface

| Parameter | Description |
|-------------|--|
| Network | Name of the network to which the device is connected |
| Address(es) | Assigned AS-i address for the slave device in range of 1(A or B) to 31(A or B) for a total of up to 62 slave devices |

10.4.2 Exchanging data between the user program and AS-i slaves

10.4.2.1 STEP 7 basic configuration

The AS-i master reserves a 62-byte data area in the I/O area of the CPU. Access to the digital data is performed here in bytes; for each slave, there is one byte of input and one byte of output data.

The assignment of the AS-i connections of the AS-i digital slaves to the data bits of the assigned byte is indicated in the inspection window of the AS-i master CM 1243-2.

| I address | O address | AS-i address | HW ID |
|-----------|-----------|--------------|-------|
| | | 0 | 335 |
| 2 | 2 | 1A | 336 |
| 33 | 33 | 1B | 337 |
| 3 | 3 | 2A | 338 |
| 34 | 34 | 2B | 339 |
| 4 | 4 | 3A | 340 |
| 35 | 35 | 3B | 341 |
| 5 | 5 | 4A | 342 |
| 36 | 36 | 4B | 343 |
| 6 | 6 | 5A | 344 |
| 37 | 37 | 5B | 345 |
| 7 | 7 | 6A | 346 |

You can access the data of the AS-i slaves in the user program by using the displayed I/O addresses with the appropriate bit logic operations (for example, "AND") or bit assignments.

Note

"System assignment" is automatically activated if you do not configure the AS-i slaves with STEP 7.

If you do not configure any slaves, you must inform the AS-i master CM1243-2 about the actual bus configuration using the online function "ACTUAL > EXPECTED".

Further information

You can find detailed information on the AS-i master CM 1243-2 in the "AS-i master CM 1243-2 and AS-i data decoupling unit DCM 1271 for SIMATIC S7-1200" Manual (<http://support.automation.siemens.com/WW/view/en/50414115/133300>).

10.4.2.2 Configuring slaves with STEP 7

Transferring AS-i digital values

The CPU accesses the digital inputs and outputs of the AS-i slaves through the AS-i master CM1243-2 in cyclic operation. The data is accessed through I/O addresses or by means of a data record transfer.

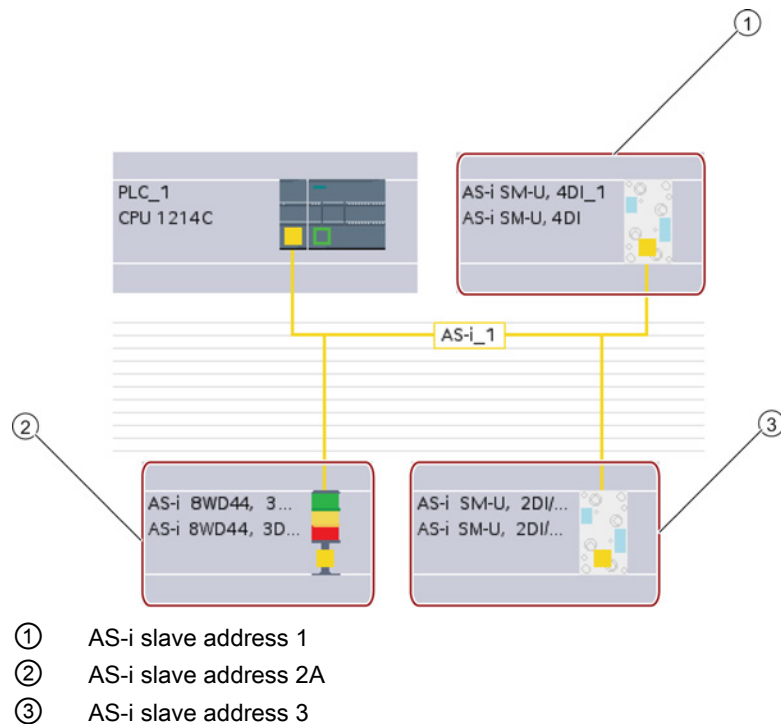

Access to the digital data is performed here in bytes (in other words, one byte is assigned to each AS-i digital slave). When you configure the AS-i slaves in STEP 7, the I/O address for accessing the data from the user program is displayed in the inspection window for the respective AS-i slave.

The digital input module (AS-i SM-U, 4DI) in the AS-i network above has been assigned slave address 1. By clicking on the digital input module, the "AS interface" tab in the device "Properties" displays the slave address, as shown below:

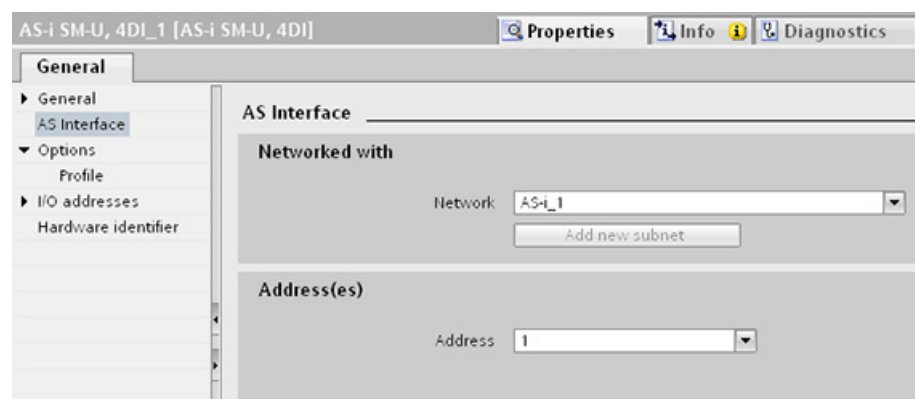

The digital input module (AS-i SM-U, 4DI) in the AS-i network above has been assigned I/O address 2. By clicking on the digital input module, the "I/O addresses" tab in the device "Properties" displays the I/O address, as shown below:

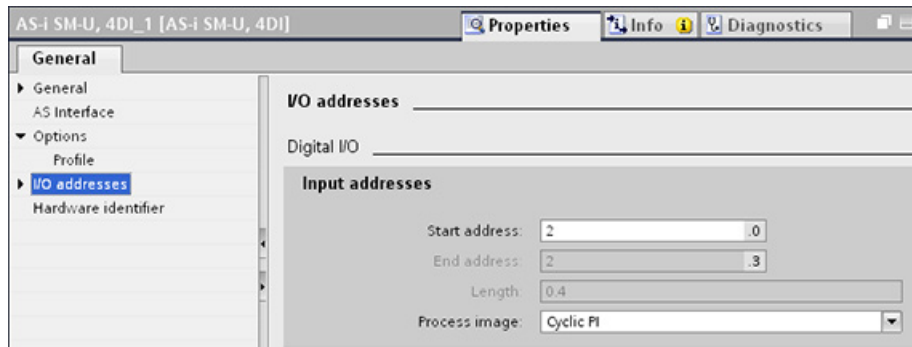

You can access the data of the AS-i slaves in the user program by using their I/O addresses with the appropriate bit logic operations (for example, "AND") or bit assignments. The following simple program illustrates how the assignment works:

Input 2.0 is polled in this program. In the AS-i system, this input belongs to slave1 (Input byte 2, bit 0). Output 4.3, which is then set, corresponds to AS-i slave 3 (Output byte 4, bit 3)

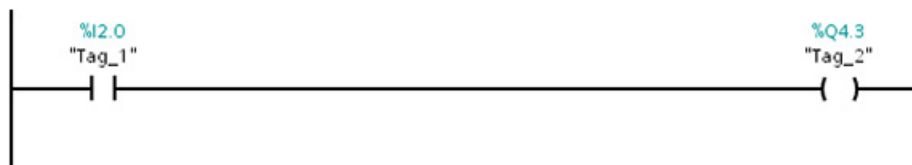

Transferring AS-i analog values

You can access analog data of an AS-i slave through the process image of the CPU if you have configured this AS-i slave in STEP 7 as an analog slave.

If you did not configure the analog slave in STEP 7, you can only access the data of the AS-i slave through the acyclic functions (data record interface). In the user program of the CPU, AS-i calls are read and written using the RDREC (read data record) and WRREC (write data record) distributed I/O instructions.

Note

A configuration of the AS-i slaves specified through STEP 7 and downloaded into the S7 station is transferred by the CPU on the AS-i master CM1243-2 during S7 station start-up. Any existing configuration that was determined through the "System assignment" online function (Page 582) ("ACTUAL -> EXPECTED") will be overwritten.

Further information

You can find detailed information on the AS-i master CM 1243-2 in the "AS-i master CM 1243-2 and AS-i data decoupling unit DCM 1271 for SIMATIC S7-1200" Manual (<http://support.automation.siemens.com/WW/view/en/50414115/133300>).

10.4.3 Distributed I/O instructions

Refer to "Distributed I/O (PROFINET, PROFIBUS, or AS-i)" (Page 314) for information on how to use the distributed I/O instructions with these communication networks.

10.4.4 Working with AS-i online tools

Changing AS-i operational modes online

You must go online to view and change the AS-i operational modes.

In order to go online, you must first be in "Device configuration" with the AS-i master CM1243-2 module selected, and then click the "Go online" button in the toolbar. Next, select the "Online and diagnostics" command from the "Online" menu.

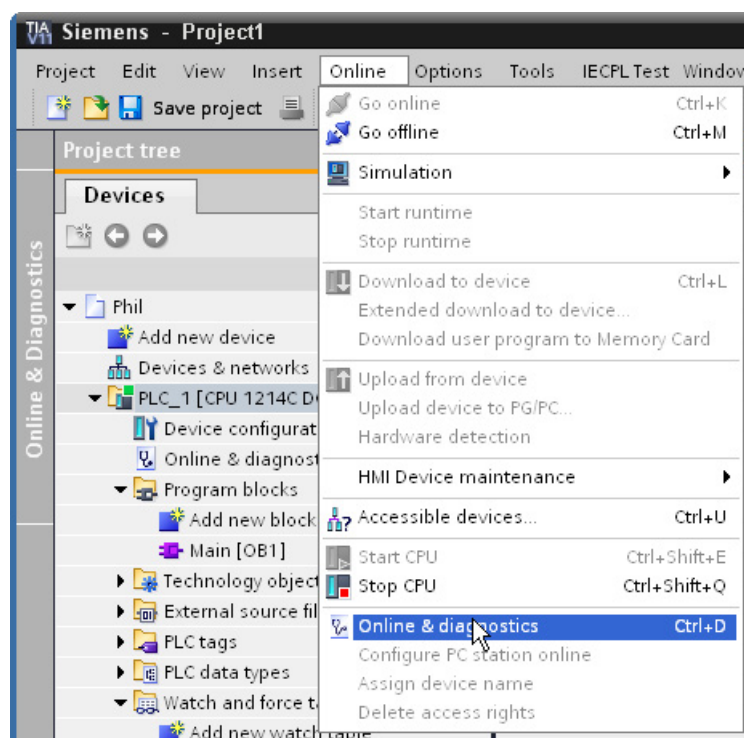

There are two AS-i operational modes:

- Protection mode:
 - You cannot change AS-i slave device and CPU I/O addresses.
 - The green "CM" LED is OFF.
- Configuration mode:
 - You can make required changes in your AS-i slave device and CPU I/O addresses.
 - The green "CM" LED is ON.

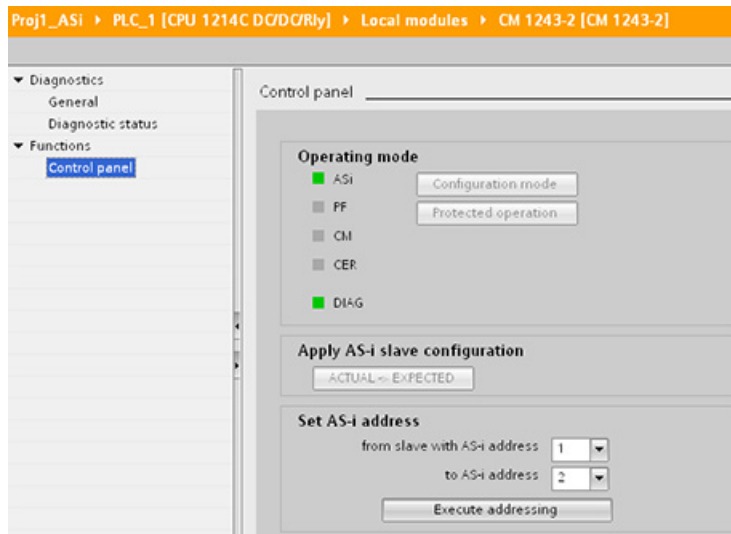

In the "Set AS-i address" field, you can change the AS-i slave address. A new slave that has not been assigned an address always has address 0. It is detected by the master as a new slave without an address assignment and is not included in normal communication until assigned an address.

Configuration error

When the yellow "CER" LED is ON, there is an error in the AS-i slave device configuration. Select the "ACTUAL > EXPECTED" button to overwrite the AS-i master CM1243-2 module slave device configuration with the AS-i field network slave device configuration.

10.5 S7 communication

10.5.1 GET and PUT (Read and write from a remote CPU) instructions

You can use the GET and PUT instructions to communicate with S7 CPUs through PROFINET and PROFIBUS connections. This is only possible if the "Permit access with PUT/GET communication" function is activated for the partner CPU in the "Protection" property of the local CPU properties:

- Accessing data in a remote CPU: An S7-1200 CPU can only use absolute addresses in the ADDR_x input field to address variables of remote CPUs (S7-200/300/400/1200).
- Accessing data in a standard DB: An S7-1200 CPU can only use absolute addresses in the ADDR_x input field to address DB variables in a standard DB of a remote S7 CPU.
- Accessing data in an optimized DB: An S7-1200 CPU cannot access DB variables in an optimized DB of a remote S7-1200 CPU.
- Accessing data in a local CPU: An S7-1200 CPU can use either absolute or symbolic addresses as inputs to the RD_x or SD_x input fields of the GET or PUT instruction, respectively.

Note

V4.0 CPU program GET/PUT operation is not automatically enabled

A V3.0 CPU program GET/PUT operation is automatically enabled in a V4.0 CPU.

However, a V4.0 CPU program GET/PUT operation in a V4.0 CPU is not automatically enabled. You must go the CPU "Device configuration", inspector window "Properties" tab, "Protection" property to enable GET/PUT access (Page 190).

Table 10- 36 GET and PUT instructions

| LAD / FBD | SCL | Description |
|-----------|---|--|
| | <pre>"GET_DB" (req:=_bool_in_, ID:=_word_in_, ndr=>_bool_out_, error=>_bool_out_, status=>_word_out_, addr_1:=_remote_inout_, [...addr_4:=_remote_inout_,] rd_1:=_variant_inout_ [...rd_4:=_variant_inout_]);</pre> | <p>Use the GET instruction to read data from a remote S7 CPU. The remote CPU can be in either RUN or STOP mode. STEP 7 automatically creates the DB when you insert the instruction.</p> |
| | <pre>"PUT_DB" (req:=_bool_in_, ID:=_word_in_, done=>_bool_out_, error=>_bool_out_, status=>_word_out_, addr_1:=_remote_inout_, [...addr_4:=_remote_inout_,] sd_1:=_variant_inout_, [...sd_4:=_variant_inout_]);</pre> | <p>Use the PUT instruction to write data to a remote S7 CPU. The remote CPU can be in either RUN or STOP mode. STEP 7 automatically creates the DB when you insert the instruction.</p> |

Table 10- 37 Data types for the parameters

| Parameter and type | Data type | Description |
|--------------------|-----------|-----------------|
| REQ | Input | Bool |
| ID | Input | CONN_PRG (Word) |
| NDR (GET) | Output | Bool |
| DONE (PUT) | Output | Bool |

| Parameter and type | | Data type | Description |
|--------------------------|------------------|--------------|--|
| ERROR STATUS | Output Output | Bool Word | <ul style="list-style-type: none"> • ERROR=0 STATUS value: <ul style="list-style-type: none"> – 0000H: neither warning nor error – <> 0000H: Warning, STATUS supplies detailed information • ERROR=1 There is an error. STATUS supplies detailed information about the nature of the error. |
| ADDR_1 | InOut | Remote | Pointer to the memory areas in the remote CPU that stores the data to be read (GET) or that is sent (PUT). |
| ADDR_2 | InOut | Remote | |
| ADDR_3 | InOut | Remote | |
| ADDR_4 | InOut | Remote | |
| RD_1 (GET) SD_1 (PUT) | InOut | Variant | Pointer to the memory areas in the local CPU that stores the data to be read (GET) or sent (PUT). |
| RD_2 (GET) SD_2 (PUT) | InOut | Variant | Data types allowed: Bool (only a single bit allowed), Byte, Char, Word, Int, DWord, DInt, or Real. |
| RD_3 (GET) SD_3 (PUT) | InOut | Variant | Note: If the pointer accesses a DB, you must specify the absolute address, such as: |
| RD_4 (GET) SD_4 (PUT) | InOut | Variant | P# DB10.DBX5.0 Byte 10 In this case, 10 represents the number of bytes to GET or PUT. |

You must ensure that the length (number of bytes) and data types for the ADDR_x (remote CPU) and RD_x or SD_x (local CPU) parameters match. The number after the identifier "Byte" is the number of bytes referenced by the ADDR_x, RD_x, or SD_x parameter.

Note

The total number of bytes received on a GET instruction or the total number of bytes sent on a PUT instruction is limited. The limitations are based on how many of the four possible address and memory areas you use:

- If you use only ADDR_1 and RD_1/SD_1, a GET instruction can get 222 bytes and a PUT instruction can send 212 bytes.
- If you use ADDR_1, RD_1/SD_1, ADDR_2, and RD_2/SD_2, a GET instruction can get a total of 218 bytes and a PUT instruction can send a total of 196 bytes.
- If you use ADDR_1, RD_1/SD_1, ADDR_2, RD_2/SD_2, ADDR_3, and RD_3/SD_3 a GET instruction can get a total of 214 bytes and a PUT instruction can send a total of 180 bytes.
- If you use ADDR_1, RD_1/SD_1, ADDR_2, RD_2/SD_2, ADDR_3, RD_3/SD_3, ADDR_4, RD_4/SD_4 a GET instruction can get a total of 210 bytes and a PUT instruction can send a total of 164 bytes.

The sum of the number of bytes of each of your address and memory area parameters must be less than or equal to the defined limits. If you exceed these limits, the GET or PUT instruction returns an error.

On the rising edge of the REQ parameter, the read operation (GET) or write operation (PUT) loads the ID, ADDR_1, and RD_1 (GET) or SD_1 (PUT) parameters.

- For GET: The remote CPU returns the requested data to the receive areas (RD_x), starting with the next scan. When the read operation has completed without error, the NDR parameter is set to 1. A new operation can only be started only after the previous operation has completed.
- For PUT: The local CPU starts sending the data (SD_x) to the memory location (ADDR_x) in the remote CPU. When the write operation has completed without error, the remote CPU returns an execution acknowledgement. The DONE parameter of the PUT instruction is then set to 1. A new write operation can only be started after the previous operation has completed.

Note

To ensure data consistency, always evaluate when the operation has been completed (NDR = 1 for GET, or DONE = 1 for PUT) before accessing the data or initiating another read or write operation.

The ERROR and STATUS parameters provide information about the status of the read (GET) or write (PUT) operation.

Table 10- 38 Error information

| ERROR | STATUS (decimal) | Description |
|-------|------------------|---|
| 0 | 11 | <ul style="list-style-type: none"> • New job cannot take effect since previous job is not yet completed. • The job is now being processed in a priority class having lower priority. |
| 0 | 25 | Communication has started. The job is being processed. |
| 1 | 1 | Communications problems, such as: <ul style="list-style-type: none"> • Connection description not loaded (local or remote) • Connection interrupted (for example: cable, CPU is turned off, or CM/CB/CP is in STOP mode) • Connection to partner not yet established |
| 1 | 2 | Negative acknowledgement from the partner device. The task cannot be executed. |
| 1 | 4 | Errors in the send area pointers (RD_x for GET, or SD_x for PUT) involving the data length or the data type. |
| 1 | 8 | Access error on the partner CPU |
| 1 | 10 | Access to the local user memory not possible (for example, attempting to access a deleted DB) |
| 1 | 12 | When the SFB was called: <ul style="list-style-type: none"> • An instance DB was specified that does not belong to GET or PUT • No instance DB was specified, but rather a shared DB • No instance DB found (loading a new instance DB) |

| ERROR | STATUS (decimal) | Description |
|-------|---------------------|--|
| 1 | 20 | <ul style="list-style-type: none"> Exceeded the maximum number of parallel jobs/instances The instances were overloaded at CPU-RUN This status is possible for first execution of the GET or PUT instruction |
| 1 | 27 | There is no corresponding GET or PUT instruction in the CPU. |

10.5.2 Creating an S7 connection

Connection mechanisms

To access remote connection partners with PUT/GET instructions, the user must also have permission.

By default, the "Permit access with PUT/GET communication" option is not enabled. In this case, read and write access to CPU data is only possible for communication connections that require configuration or programming both for the local CPU and for the communication partner. Access through BSEND/BRCV instructions is possible, for example.

Connections for which the local CPU is only a server (meaning that no configuration/programming of the communication with the communication partner exists at the local CPU), are therefore not possible during operation of the CPU, for example:

- PUT/GET, FETCH/WRITE or FTP access through communication modules
- PUT/GET access from other S7 CPUs
- HMI access through PUT/GET communication

If you want to allow access to CPU data from the client side, that is, you do not want to restrict the communication services of the CPU, refer to "Access protection for the S7-1200 CPU" (Page 190) for more information.

Connection types

The connection type that you select creates a communication connection to a partner station. The connection is set up, established, and automatically monitored.

In the Devices and Networks portal, use the "Network view" to create the network connections between the devices in your project. First, click the "Connections" tab, and then select the connection type with the dropdown, just to the right (for example, an S7 connection). Click the green (PROFINET) box on the first device, and drag a line to the PROFINET box on the second device. Release the mouse button and your PROFINET connection is joined.

Refer to "Creating a network connection" (Page 149) for more information.

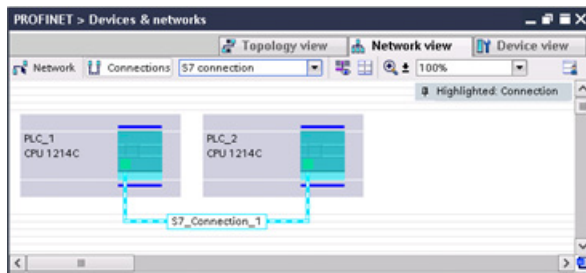

Click the "Highlighted: Connection" button to access the "Properties" configuration dialog of the communication instruction.

10.5.3 Configuring the Local/Partner connection path between two devices

Configuring General parameters

You specify the communication parameters in the "Properties" configuration dialog of the communication instruction. This dialog appears near the bottom of the page whenever you have selected any part of the instruction.

Refer to "Device configuration: Configuring the Local/Partner connection path (Page 150)" for more information.

In the "Address Details" section of the Connection parameters dialog, you define the TSAPs or ports to be used. The TSAP or port of a connection in the CPU is entered in the "Local TSAP" field. The TSAP or port assigned for the connection in your partner CPU is entered under the "Partner TSAP" field.

10.5.4 GET/PUT connection parameter assignment

The GET/PUT instructions connection parameter assignment is a user aid for configuring CPU-to-CPU S7 communication connections.

After inserting a GET or PUT block, the GET/PUT instructions connection parameter assignment is started:

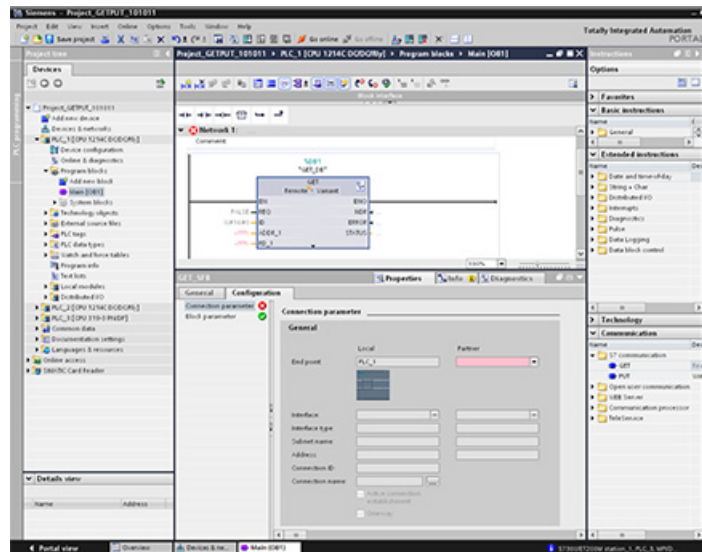

The inspector window displays the properties of the connection whenever you have selected any part of the instruction. You can specify the communication parameters in the "Configuration" tab of the "Properties" for the communication instruction.

Note

V4.0 CPU program GET/PUT operation is not automatically enabled

A V3.0 CPU program GET/PUT operation is automatically enabled in a V4.0 CPU.

However, a V4.0 CPU program GET/PUT operation in a V4.0 CPU is not automatically enabled. You must go the CPU "Device configuration", inspector window "Properties" tab, "Protection" property to enable GET/PUT access (Page 190).

10.5.4.1 Connection parameters

The "Connection parameters" page allows you to configure the necessary S7 connection and to configure the parameter "Connection ID" that is referenced by the GET/PUT block parameter "ID". The page's content has information about the local endpoint and allows you to define the local interface. You can also define the partner end point.

The "Block parameters" page allows you to configure the additional block parameters.

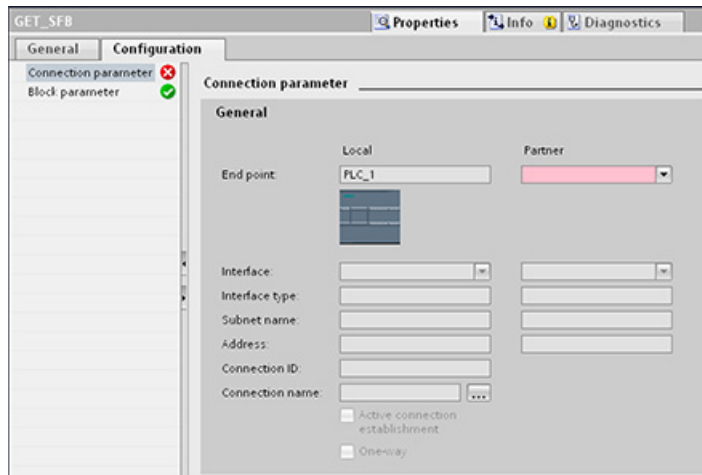

Table 10- 39 Connection parameter: General definitions

| Parameter | | Definition |
|----------------------------------|---|---|
| Connection parameter: General | End point | "Local End point": Name assigned to the Local CPU "Partner End point": Name assigned to the Partner (remote) CPU Note: In the "Partner End point" dropdown list, the system displays all potential S7 connection partners of the current project as well as the option "unspecified". An unspecified partner represents a communication partner which is not currently in the STEP 7 project (for example, a third party device communication partner). |
| | Interface | Name assigned to the interfaces Note: You can change the connection by changing the Local and Partner interfaces |
| | Interface type | Type of interface |
| | Subnet name | Name assigned to the subnets |
| | Address | Assigned IP addresses Note: You can specify the remote address of a third party device for an "unspecified" communication partner. |
| | Connection ID | ID number: Automatically generated by the GET/PUT connection parameter assignment |
| | Connection name | Local and Partner CPU data storage location: Automatically generated by the GET/PUT connection parameter assignment |
| | Active connection establishment | Checkbox to select Local CPU as the active connection |
| One-way | Checkbox to specify a one-way or two-way connection; read-only Note: In a PROFINET GET/PUT connection, both the local and partner devices can act as a server or a client. This allows a two-way connection, and the "One-way" checkbox is unchecked. In a PROFIBUS GET/PUT connection, in some cases, the Partner device can only act as a server (for example, an S7-300), and the "One-way" checkbox is checked. | |

Connection ID parameter

There are three ways to change the system-defined connection IDs:

1. The user can change the current ID directly on the GET/PUT block. If the new ID belongs to an already existing connection, the connection is changed.
2. The user can change the current ID directly on the GET/PUT block, but the new ID does not already exist. A new S7 connection is created by the system.
3. The user can change the current ID through the "Connection overview" dialog: The user-input is synchronized with the ID-parameter on the corresponding GET/PUT block.

Note

The parameter "ID" of the GET/PUT block is not a connection name, but a numerical expression which is written like the following example: W#16#1

Connection name parameter

The connection name is editable through a special user control, the "Connection overview" dialog. This dialog offers all the available S7 connections which could be selected as an alternative for the current GET/PUT communication. The user can create a completely new connection in this table. Click the button to the right of the "Connection name" field to start the "Connection overview" dialog.

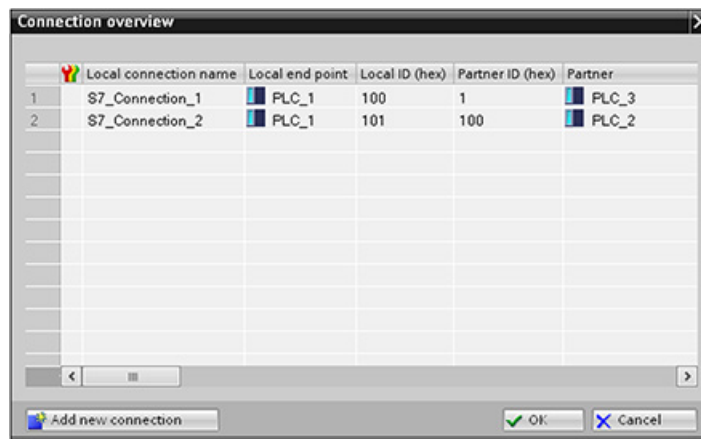

10.5.4.2 Configuring a CPU-to-CPU S7 connection

Given the configuration of PLC_1, PLC_2, and PLC_3 as shown in the figure below, insert GET or PUT blocks for "PLC_1".

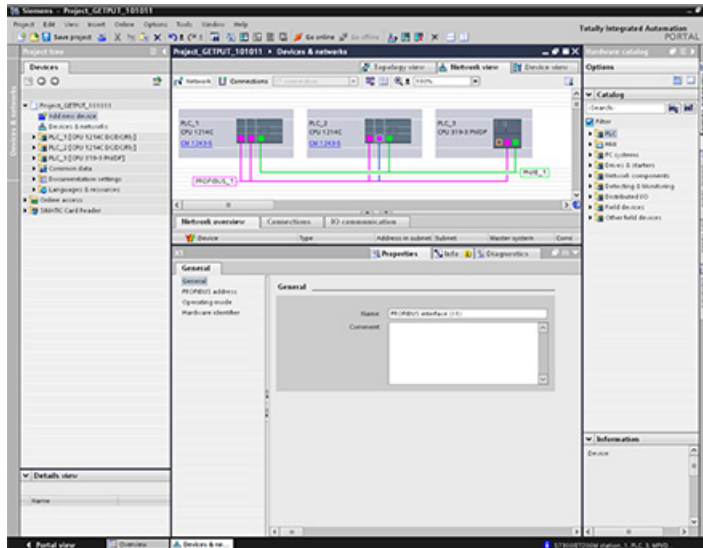

For the GET or PUT instruction, the "Properties" tab is automatically displayed in the inspector window with the following menu selections:

- "Configuration"
- "Connection parameters"

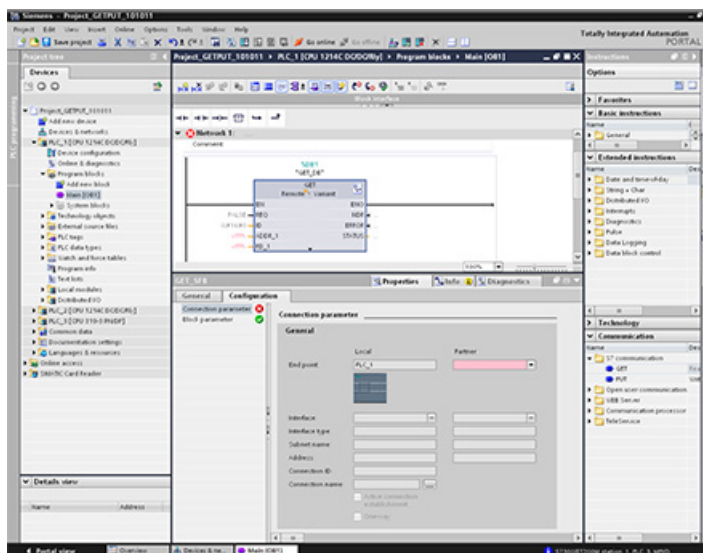

Configuring a PROFINET S7 connection

For the "Partner End point", select "PLC_3".

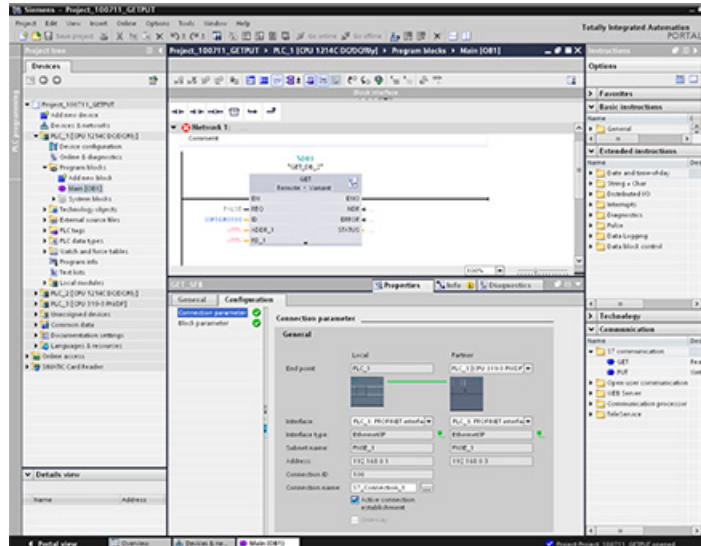

The system reacts with the following changes:

Table 10- 40 Connection parameter: General values

| Parameter | Definition | |
|----------------------------------|----------------|--|
| Connection parameter: General | End point | "Local End point" contains "PLC_1" as read-only. "Partner End point" field contains "PLC_3[CPU319-3PN/DP]": <ul style="list-style-type: none"> The color switches from red to white The "Partner" device image is shown. A connection line appears between the PLC_1- and PLC_3 device images (green Ethernet line). |
| | Interface | "Local Interface" contains "CPU1214C DC/DC/DC, PROFINET interface (R0/S1)". "Partner Interface" contains: "CPU319-3PN/DP, PROFINET interface (R0/S2)". |
| | Interface type | "Local Interface type" contains "Ethernet/IP"; control is read-only. "Partner Interface type" contains "Ethernet/IP"; control is read-only. Interface type images are shown at the right beside the Local and Partner "Interface type" (green Ethernet icon). |
| | Subnet name | "Local Subnet name" contains "PN/IE_1"; control is read only. "Partner Subnet name" contains "PN/IE_1"; control is read only. |
| | Address | "Local Address" contains the Local IP address; control is read only. "Partner Address" contains the Partner IP address; control is read only. |
| | Connection ID | "Connection ID" contains "100". In the Program editor, in the Main [OB1], the GET/PUT block "Connection ID" value also contains "100". |

| Parameter | Definition |
|---------------------------------|---|
| Connection name | "Connection name" contains the default connection name (for example, "S7_Connection_1"); control is enabled. |
| Active connection establishment | Checked and enabled to select the Local CPU as the active connection. |
| One-way | Read-only and unchecked. Note: "PLC_1" (an S7-1200 CPU 1214CDC/DC/Rly) and "PLC_3" (an S7-300 CPU 319-3PN/DP) can both act as a server and a client in a PROFINET GET/PUT connection, allowing a two-way connection. |

The GET/PUT icon in the Property View tree also changes from red to green.

Completed PROFINET S7 connection

In the "Network view", a two-way S7 connection is shown in the "Connections" table between "PLC_1" and "PLC_3".

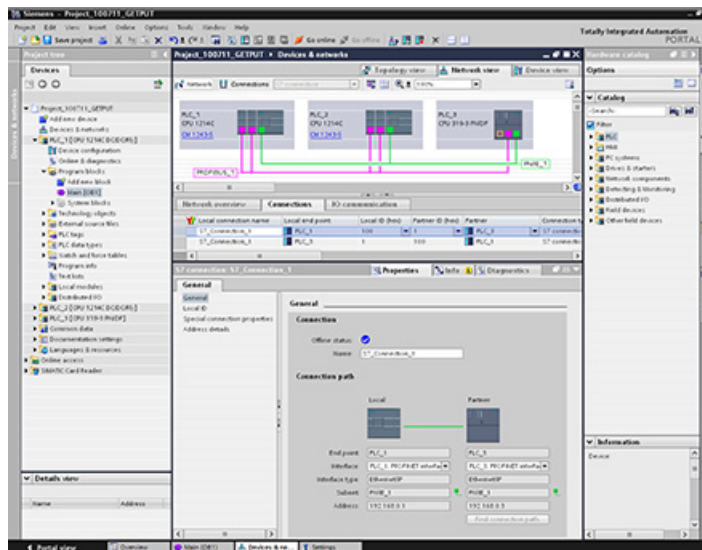

Configuring a PROFIBUS S7 connection

For the "Partner End point", select "PLC_3".

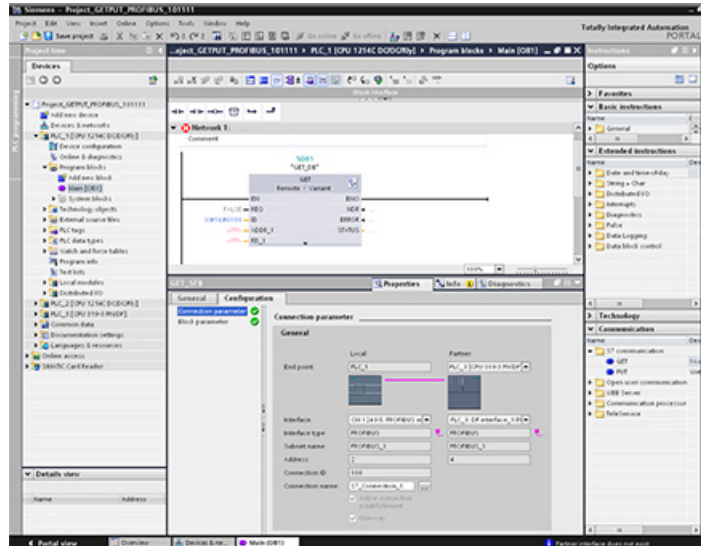

The system reacts with the following changes:

Table 10- 41 Connection parameter: General values

| Parameter | Definition | |
|----------------------------------|----------------|---|
| Connection parameter: General | End point | "Local End point" contains "PLC_1" as read-only. "Partner End point" field contains "PLC_3[CPU319-3PN/DP]": <ul style="list-style-type: none"> The color switches from red to white The "Partner" device image is shown. A connection line appears between the PLC_1- and PLC_3 device images (purple PROFIBUS line). |
| | Interface | "Local Interface" contains "CPU1214C DC/DC/DC, PROFIBUS interface (R0/S1)". "Partner Interface" contains: "CPU319-3PN/DP, PROFIBUS interface (R0/S2)". |
| | Interface type | "Local Interface type" contains "PROFIBUS"; control is read-only. "Partner Interface type" contains " PROFIBUS "; control is read-only. Interface type images are shown at the right beside the Local and Partner "Interface type" (purple PROFIBUS icon). |
| | Subnet name | "Local Subnet name" contains " PROFIBUS _1"; control is read only. "Partner Subnet name" contains " PROFIBUS _1"; control is read only. |
| | Address | "Local Address" contains the Local IP address; control is read only. "Partner Address" contains the Partner IP address; control is read only. |
| | Connection ID | "Connection ID" contains "100". In the Program editor, in the Main [OB1], the GET/PUT block "Connection ID" value also contains "100". |

| Parameter | Definition | |
|---------------------------------|--|--|
| Connection name | "Connection name" contains the default connection name (for example, "S7_Connection_1"); control is enabled. | |
| Active connection establishment | Read-only, checked, and enabled to select the Local CPU as the active connection. | |
| One-way | Read-only and checked. Note: "PLC_3" (an S7-300 CPU319-3PN/DP) can act only as a server (cannot also be a client) in a PROFIBUS GET/PUT connection, allowing only a one-way connection. | |

The GET/PUT icon in the Property View tree also changes from red to green.

Completed PROFIBUS S7 connection

In the "Network view", a one-way S7 connection is shown in the "Connections" table between "PLC_1" and "PLC_3".

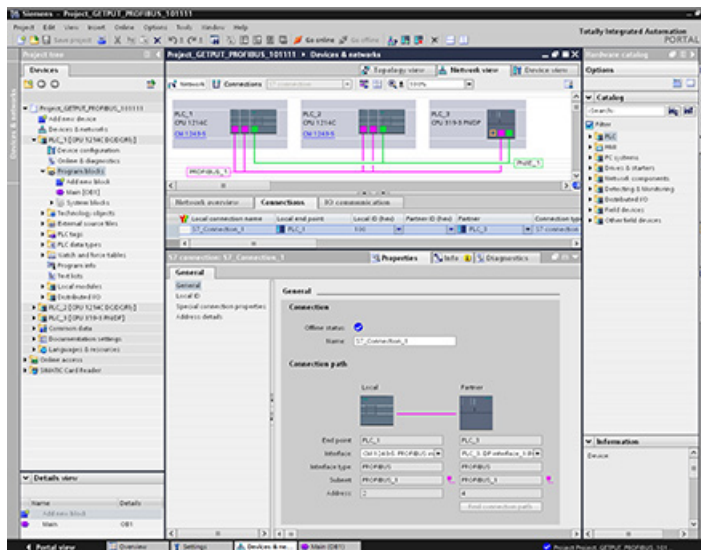

Web server

The Web server for the S7-1200 provides Web page access to data about your CPU and process data.

You can access the S7-1200 Web pages from a PC or from a mobile device. The Web server displays the pages in a format and size compatible with the device you use to access the Web pages. The Web server supports a minimum resolution of 240 x 240 pixels.



Standard Web pages

The S7-1200 includes standard Web pages that you can access from the Web browser of your PC (Page 606) or from a mobile device (Page 607):

- Introduction (Page 613) - entry point to the standard Web pages
- Start Page (Page 614) - general information about the CPU
- Identification (Page 615) - detailed information about the CPU including serial, order, and version numbers
- Module Information (Page 616) - information about the modules in the local rack and the ability to update firmware
- Communication (Page 620) - information about the network addresses, physical properties of the communication interfaces, and communication statistics
- Diagnostic Buffer (Page 616) - the diagnostic buffer
- Variable Status (Page 620) - CPU variables and I/O, accessible by address or PLC tag name
- File Browser (Page 622) - browser for files stored internally in the CPU or on a memory card, for example, data logs and recipes
- Login (Page 610) - log in as a different user, or log out.

These pages are built in to the S7-1200 CPU, and are available in English, German, French, Spanish, Italian, and Simplified Chinese. Some pages require additional user privileges (Page 604) that you configure in STEP 7 in order to view the page. For details about the standard Web pages, and how to access them, refer to the Standard Web pages (Page 609) section.

Note

S7-1200 V4.0 CPUs do not include a separate firmware update standard Web page. The firmware update feature is included in the module information page.

User-defined Web pages

The S7-1200 also provides support for you to create user-defined Web pages that can access CPU data. You can develop these pages with the HTML authoring software of your choice, and include pre-defined "AWP" (Automation Web Programming) commands in your HTML code to access CPU data. Refer to the User-defined Web pages (Page 625) chapter for specific information on the development of user-defined Web pages, and the associated configuration and programming in STEP 7.

You can access the user-defined pages from either a PC or mobile device from the standard Web pages.

Web browser requirement

The Web server supports the following PC Web browsers:

- Internet Explorer 8.0
- Internet Explorer 9.0
- Mozilla Firefox 17.0.1
- Google Chrome 23.0
- Apple Safari 5.1.7 (Windows)
- Apple Safari 6.0.2 (Mac)

The Web server supports the following mobile device Web browsers:

- Internet Explorer 6.0 and earlier, for HMI panels
- Mobile Safari 7534.48.3 (iOS 5.0.1)
- Mobile Android Browser 2.3.4
- Mobile Google Chrome 23.0

For browser-related restrictions that can interfere with the display of standard or user-defined Web pages, see the Constraints (Page 664) section.

11.1 Enabling the Web server

You enable the Web server in STEP 7 from Device Configuration for the CPU to which you intend to connect.

To enable the Web server, follow these steps:

1. Select the CPU in the Device Configuration view.
2. In the inspector window, select "Web server" from the CPU properties.
3. Select the check box for "Activate web server on this module".
4. To require secure access to the Web server, select the "Permit access only with HTTPS" check box.

WARNING

Unauthorized access to the CPU through the Web server

Unauthorized access to the CPU or changing PLC variables to invalid values could disrupt process operation and could result in death, severe personal injury and/or property damage.

Because enabling the Web server allows authorized users to perform operating mode changes, writes to PLC data, and firmware updates, Siemens recommends that you observe the following security practices:

- Enable access to the Web server only with the HTTPS protocol.
- Password-protect Web server user IDs (Page 604) with a strong password. Strong passwords are at least ten characters in length, mix letters, numbers, and special characters, are not words that can be found in a dictionary, and are not names or identifiers that can be derived from personal information. Keep the password secret and change it frequently.
- Do not extend the default minimum privileges of the "Everybody" user.
- Perform error-checking and range-checking on your variables in your program logic because Web page users can change PLC variables to invalid values.
- Use a secure Virtual Private Network (VPN) to connect to the S7-1200 PLC Web server from a location outside your protected network.

After you download the device configuration, you can use the standard Web pages to access the CPU. If you select "Enable" for "Automatic update", standard Web pages refresh every ten seconds.

If you created and enabled user-defined Web pages (Page 625), you can access them from the standard Web page menu.

Note

Device exchange: replacing a V3.0 CPU with a V4.0 CPU and project conversion

If you replace an existing V3.0 CPU with a V4.0 CPU (Page 995) and convert your V3.0 project to a V4.0 project, note that STEP 7 and the V4.0 CPU retain the Web server settings for

- "Activate web server on this module"
 - "Permit access only with HTTPS"
-

Note

If a "Download in RUN" (Page 803) is in progress, standard and user-defined Web pages do not update data values or permit you to write data values until the download is complete. The Web server discards any attempts to write data values while a download is in progress.

Enabling other languages for the Web server

You can also optionally select other languages for the display of the standard Web pages. Select "User interface languages" from the Properties tab of your device configuration, and you can then assign a STEP 7 project language to one of the six languages that the Web server supports. After you download the device configuration, the standard Web pages provide a selector for the user interface language. If you do not select any languages, the default is English.

11.2 Configuring Web server users

You can configure users with various privilege levels for accessing the CPU through the Web server.

To configure Web server users and their associated privileges, follow these steps:

1. Select the CPU in the Device Configuration view.
2. In the inspector window, select "Web server" from the CPU properties and enable the Web server (Page 603).
3. Select "User management" in the Web server properties.
4. Enter user names, access levels, and passwords for the user logins that you want to provide.

After you download the configuration to the CPU, only authorized users can access Web server functions for which they have privileges.

Web server access levels

STEP 7 provides a default user named "Everybody" with no password. By default, this user has no additional privileges and can only view Web pages when logged in. You can, however, grant additional privileges to the "Everybody" user as well as other users that you configure:

- Query diagnostics
- Read tags
- Write tags
- Read tag status
- Write tag status
- Open user-defined pages
- Write in user-defined pages
- Read files
- Write/delete files
- Change operating mode
- Flash LEDs
- Perform firmware update

Without adding additional privileges, the "Everybody" user can view only the Start (Page 614) and Introduction (Page 613) pages.

WARNING

Access to Web server

Granting privileges to the "Everybody" user makes it possible to log in to the Web server with no password. Unauthorized access to the CPU or changing PLC variables to invalid values could disrupt process operation and could result in death, severe personal injury and/or property damage.

Because the "Everybody" user when granted sufficient privileges can perform operating mode changes, writes to PLC data, and firmware updates with no password, Siemens recommends that you observe the following security practices

- Enable access to the Web server only with the HTTPS protocol.
- Password-protect Web server user IDs with a strong password. Strong passwords are at least ten characters in length, mix letters, numbers, and special characters, are not words that can be found in a dictionary, and are not names or identifiers that can be derived from personal information. Keep the password secret and change it frequently.
- Do not extend the default minimum privileges of the "Everybody" user.
- Perform error-checking and range-checking on your variables in your program logic because Web page users can change PLC variables to invalid values.
- Use a secure Virtual Private Network (VPN) to connect to the S7-1200 PLC Web server from a location outside your protected network.

11.3 Accessing the Web pages from a PC

You can access the S7-1200 standard Web pages from a PC or from a mobile device.

To access the S7-1200 standard Web pages from a PC, follow these steps:

1. Ensure that the S7-1200 and the PC are on a common Ethernet network or are connected directly to each other with a standard Ethernet cable.
2. Open a Web browser and enter the URL "http://ww.xx.yy.zz", where "ww.xx.yy.zz" corresponds to the IP address of the S7-1200 CPU.

The Web browser opens the Introduction page.

Note

Use a secure Virtual Private Network (VPN) to connect to the S7-1200 PLC Web server from a location outside your protected network. Be aware also of any constraints (Page 664) that your Web environment or operating system might impose.

Alternatively, you can address your Web browser to a specific standard Web page. To do so, enter the URL in the form "http://ww.xx.yy.zz/<page>.html", where <page> corresponds to one of the standard Web pages:

- start (Page 614) - general information about the CPU
- identification (Page 615) - detailed information about the CPU including serial, order, and version numbers
- module (Page 616) - information about the modules in the local rack and the ability to update firmware
- communication (Page 620) - information about the network addresses, physical properties of the communication interfaces, and communication statistics
- diagnostic (Page 616) - the diagnostic buffer
- variable (Page 620) - CPU variables and I/O, accessible by address or PLC tag name
- filebrowser (Page 622) - browser for accessing data log files or recipe files stored internally in the CPU or on a memory card
- index (Page 613) - introduction page to enter the standard Web pages
- login (Page 610) - page to log in as a different user or log out. (Note that a login window is available from every page of the PC standard Web pages, but that the login page is necessary to log it from a mobile device.)

For example, if you enter "http://ww.xx.yy.zz/communication.html", the browser displays the communication page.

Secure access

Use a secure Virtual Private Network (VPN) to connect to the S7-1200 PLC Web server from a location outside your protected network. You can use `https://` instead of `http://` for secure access to the standard Web pages. When you connect to the S7-1200 with `https://`, the Web site encrypts the session with a digital certificate. The Web server transmits the data securely and it is not accessible for anyone to view. You typically get a security warning that you can confirm with "Yes" to proceed to the standard Web pages. To avoid the security warning with each secure access, you can import the Siemens software certificate to your Web browser (Page 666).

You can also configure the PLC in STEP 7 (Page 603) to be accessible only by secure access (`https`) if you choose.

11.4 Accessing the Web pages from a mobile device

To access an S7-1200 from a mobile device, you must connect your PLC to a network that connects to the Internet or to a local wireless access point. Use a secure Virtual Private Network (VPN) to connect a mobile device to the S7-1200 PLC Web server. You can use port forwarding in the wireless router to map the IP address of the PLC to an address by which a mobile device can access it from the Internet. To configure port forwarding, follow the instructions for the software configuration of your router. You can connect as many PLCs and switching devices as your router supports.

Without port forwarding, you can connect to a PLC, but only locally within range of the wireless signal.

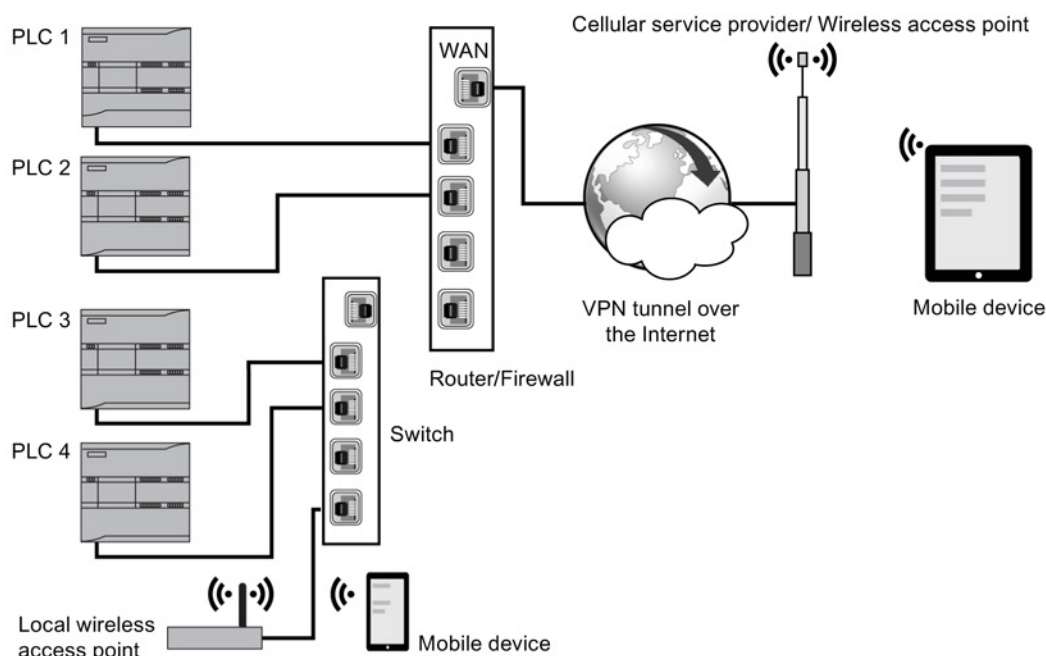

11.4 Accessing the Web pages from a mobile device

In this example, a mobile device that is within range of the local wireless access point can connect to PLC 3 and PLC 4 by their IP addresses. From the Internet outside the local wireless range, a mobile device can connect to PLC 1 and PLC 2 using the port forwarded address for each PLC.

To access the standard Web pages, you must have access to a cellular service or wireless access point. To access a PLC from the Internet, enter the port forwarded address in the Web browser of your mobile device to access the PLC, for example `http://ww.xx.yy.zz:pppp` or `https://ww.xx.yy.zz:pppp`, where `ww.xx.yy.zz` is the address of the router and `pppp` is the port assignment for a specific PLC.

For local access through a local wireless access point, enter the IP address of the CPU: `http://ww.xx.yy.zz` or `https://ww.xx.yy.zz`. You can also navigate to a specific Web page by name as described in *Accessing the Web pages from a PC* (Page 606).

Note that if you choose you can configure the PLC in STEP 7 (Page 603) to be accessible only by secure access (https).

11.5 Standard Web pages

11.5.1 Layout of the standard Web pages

Each of the standard Web pages has a common layout with navigational links and page controls. Regardless of whether you are viewing the page on a PC or on a mobile device, each page has the same content area, but the layout and navigation controls vary based on the screen size and resolution of the device. On a standard PC or large mobile device the layout of a standard Web page appears as follows:

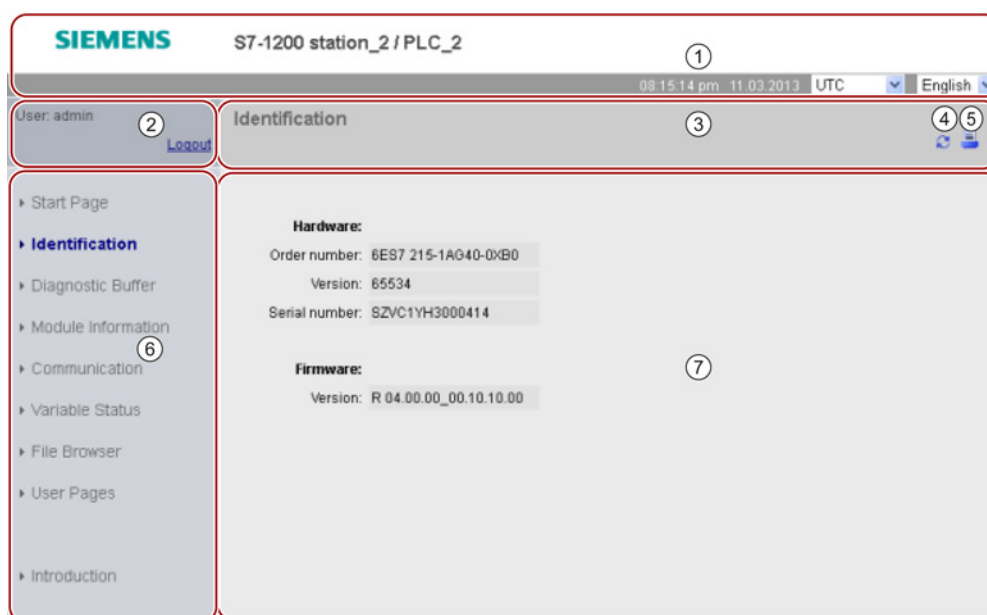

- ① Web server header with selector to display PLC Local time or UTC time, and a selector for the display language (Page 142)
- ② Log in or log out
- ③ Standard Web page header with name of the page that you are viewing. This example is the CPU Identification page. Some of the standard Web pages, such as module information, also display a navigation path here if multiple screens of that type can be accessed.
- ④ Refresh icon: for pages with automatic refresh, enables or disables the automatic refresh function; for pages without automatic refresh, causes the page to update with current data
- ⑤ Print icon: prepares and displays a printable version of the information available from the displayed page
- ⑥ Navigation area to switch to another page
- ⑦ Content area for specific standard Web page that you are viewing. This example is the CPU Identification page.

Mobile device layout

On a device where the width is less than 768 pixels, the Web server displays a mobile version of each page. The page omits the navigation area, login area, and the header area, and includes buttons for advancing backward and forward through the Web pages, and a Home page button that takes you to a Navigation page. You can also use the navigation controls provided with your mobile device for navigation. For example, on a mobile device with a screen width less than 768 pixels the Identification page appears as follows in the vertical orientation:



Note that the standard Web page illustrations in this chapter represent the standard PC Web page appearance. Each standard Web page has an equivalent mobile page appearance.

11.5.2 Logging in and user privileges

Each of the PC standard Web pages provides a login window above the navigation pane. Due to space considerations, the mobile Web pages provide a separate Login page. The S7-1200 supports multiple user logins with various access levels (privileges):

- Query diagnostics
- Read tags
- Write tags
- Read tag status
- Write tag status
- Open user-defined pages
- Write in user-defined pages
- Read files
- Write/delete files
- Change operating mode
- Flash LEDs
- Perform firmware update

You configure user roles, associated access levels (privileges), and passwords (Page 604) in the Web server user management properties of the STEP 7 device configuration of the CPU.

Logging in

Typically, you do not have to log in to view the data in the standard Web pages. STEP 7 provides an "Everybody" user that, by default, has privileges to view all of the standard Web pages. To perform certain actions such as changing the operating mode of the controller, writing values to memory, and updating the CPU firmware you must have the required privileges. Note that if you have set the protection level of the CPU to "Complete protection (no access)", then the "Everybody" user cannot access the Web server.



The log in frame is near the upper left corner on each standard Web page when displayed from a PC or a wide mobile device.

The Log In page is a separate page on small mobile devices, and is selectable from the Home page.

To log in, follow these steps:

1. Enter the user name for the Username field.
2. Enter the user password in the Password field.

Your login times out after thirty minutes of inactivity. If the currently-loaded page is continually refreshing, the login does not time out.

| |
|--|
|  WARNING |
| Unauthorized access to the CPU through the Web server |
| Unauthorized access to the CPU or changing PLC variables to invalid values could disrupt process operation and could result in death, severe personal injury and/or property damage. |
| Because enabling the Web server allows authorized users to perform operating mode changes, writes to PLC data, and firmware updates, Siemens recommends that you observe the following security practices: |
| <ul style="list-style-type: none">• Enable access to the Web server only with the HTTPS protocol.• Password-protect Web server user IDs (Page 190) with a strong password. Strong passwords are at least eight characters in length, mix letters, numbers, and special characters, are not words that can be found in a dictionary, and are not names or identifiers that can be derived from personal information. Keep the password secret and change it frequently.• Perform error-checking and range-checking on your variables in your program logic because Web page users can change PLC variables to invalid values. |

If you encounter any errors logging in, return to the Introduction page (Page 613) and download the Siemens security certificate (Page 666). You can then log in with no errors.

Logging out

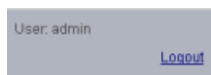

To log out, simply click the "Logout" link from any page when viewing from a PC or wide mobile device.

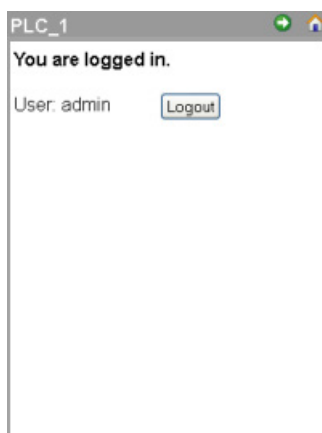

From a small mobile device, navigate to the Login/Logout page from the Home page and tap the "Logout" button.

You can continue to access and view standard Web pages when not logged in, according to the privileges of the "Everybody" user, but you cannot perform actions that require higher privileges. Each of the standard Web page descriptions defines the actions, if any, that require additional privileges.

Note**Log off prior to closing Web server**

If you have logged in to the Web server, be sure to log off prior to closing your Web browser. The Web server supports a maximum of seven concurrent logins.

11.5.3 Introduction

The Introduction page is the welcome screen for entry into the S7-1200 standard Web pages.



From this page, you click "Enter" to access the S7-1200 standard Web pages. At the top of the screen are links to useful Siemens Web sites, as well as a link to download the Siemens security certificate (Page 666).

11.5.4 Start

The Start page displays a representation of the CPU to which you are connected and lists general information about the CPU. You can also use the buttons to change the operating mode of the CPU and flash the LEDs, if you have logged in (Page 610) with those specific privileges.

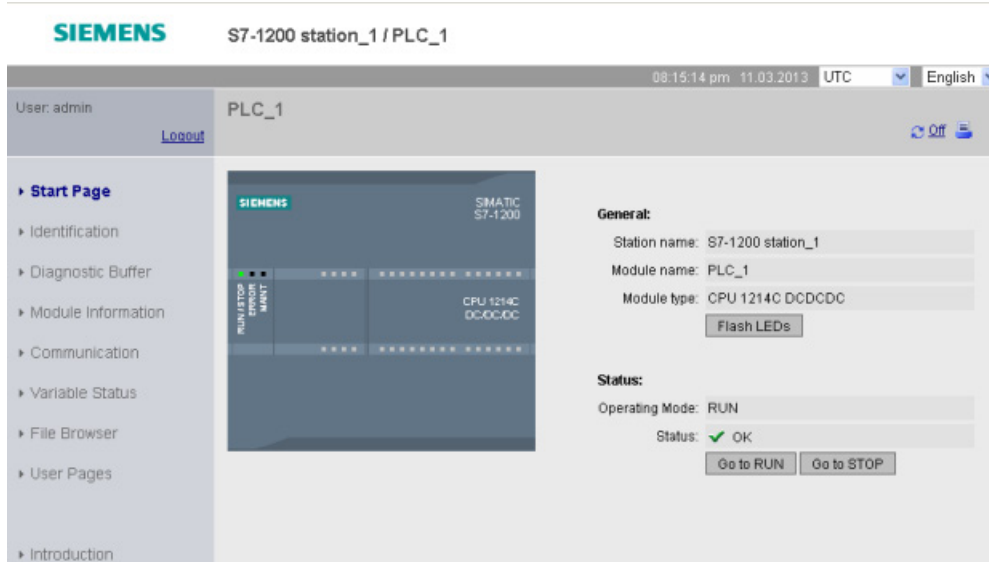

11.5.5 Identification

The Identification page displays identifying characteristics of the CPU:

- Serial number
- Order number
- Version information

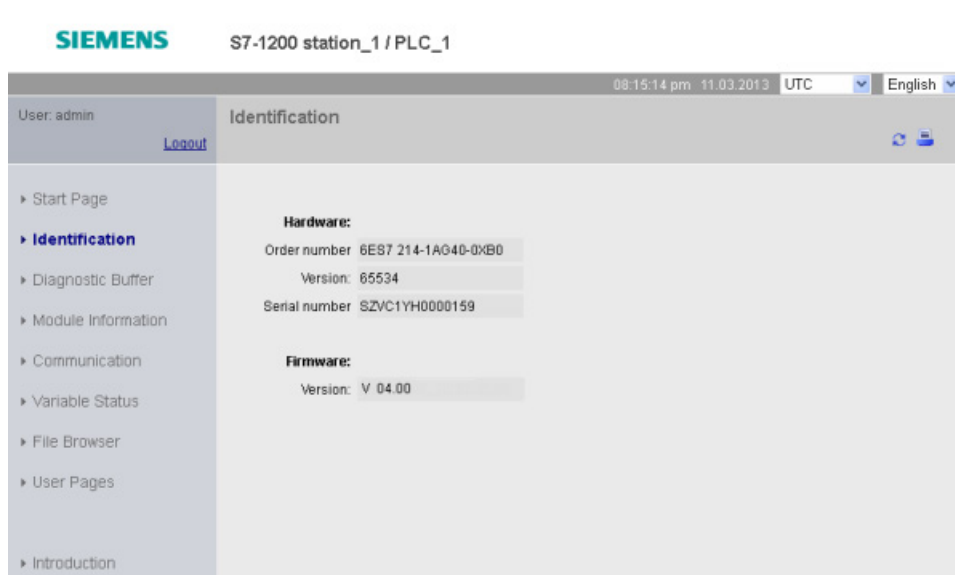

Viewing the Identification page requires the "query diagnostics" privilege. By default the "Everybody" user has this privilege with no login.

See also

Configuring Web server users (Page 604)

11.5.6 Diagnostic Buffer

The diagnostic buffer page displays diagnostic events. From the selector on the left, you can choose what range of diagnostic buffer entries to display, either 1 to 25 or 26 to 50. From the selector on the right, you can choose whether to display the times in UTC times or PLC local times. The top part of the page displays the diagnostic entries with the time and date of when the event occurred.

From the top part of the page, you can select any individual entry to show detailed information about that entry in the bottom part of the page.

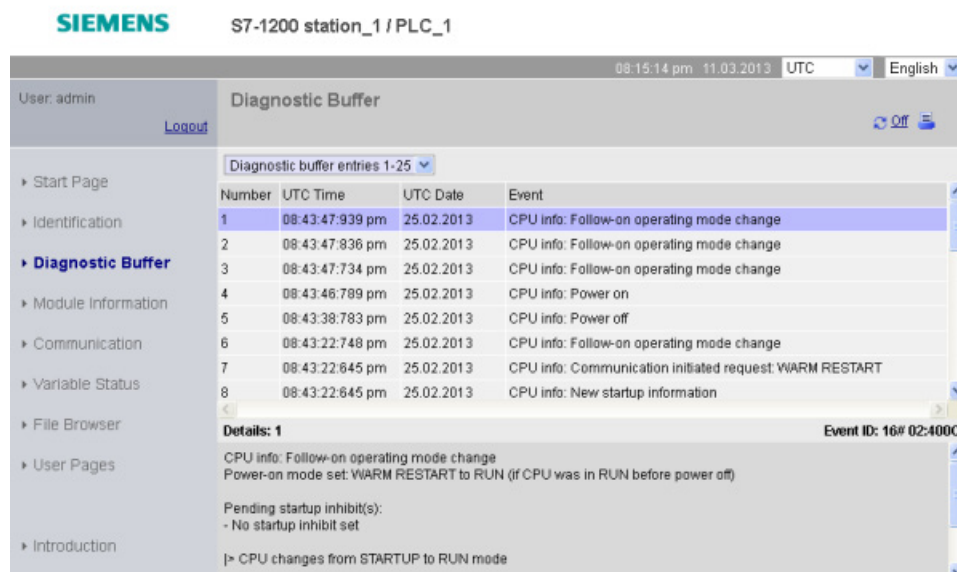

Viewing the Module Information page requires the "query diagnostics" privilege (Page 604). By default the "Everybody" user has this privilege with no login.

11.5.7 Module Information

The module information page provides information about all the modules in the local rack. The top section of the screen shows a summary of the modules, and the bottom section shows status, identification and firmware information of the selected module. The module information page also provides the capability to perform a firmware update.

Viewing the Module Information page requires the "query diagnostics" privilege (Page 604). By default the "Everybody" user has this privilege with no login.

Module information: Status tab

The status tab in the bottom section of the module information page displays a description of the current status of the module that is selected in the top section.

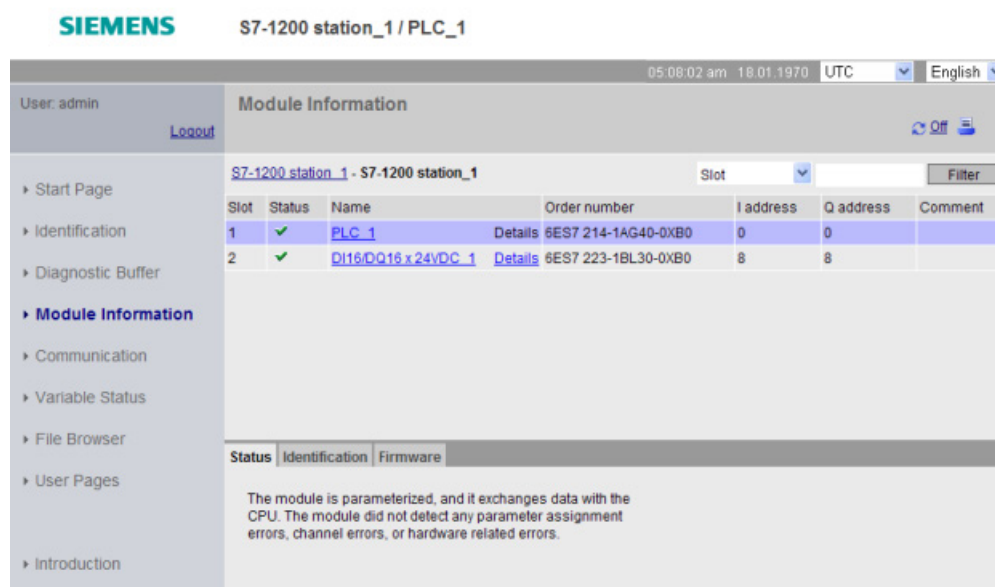

SIEMENS S7-1200 station_1 / PLC_1

User: admin Logout 05:08:02 am 18.01.1970 UTC English

Module Information

S7-1200 station_1 - S7-1200 station_1 Slot Filter

| Slot | Status | Name | Order number | I address | Q address | Comment |
|------|--------|---------------------|---|-----------|-----------|---------|
| 1 | ✓ | PLC_1 | Details 6ES7 214-1AG40-0XB0 | 0 | 0 | |
| 2 | ✓ | DI16/DO16 x 24VDC_1 | Details 6ES7 223-1BL30-0XB0 | 8 | 8 | |

Status Identification Firmware

The module is parameterized, and it exchanges data with the CPU. The module did not detect any parameter assignment errors, channel errors, or hardware related errors.

Note

The mobile device module information page displays the "I address", "Q address", and "Comment" information on the Identification tab rather than as columns in the main module information table.

Drilling down

You can select a link in the top section to drill down to the module information for that particular module. Modules with submodules have links for each submodule. The type of information that is displayed varies with the module selected. For example, the module information dialog initially displays the name of the SIMATIC 1200 station, a status indicator, and a comment. If you drill down to the CPU, the module information displays the name of the digital and analog inputs and outputs that the CPU model provides (for example, "DI14/DO10", "AI2"), addressing information for the I/O, status indicators, slot numbers, and comments.

| Slot | Status | Name | Order number | I address | Q address | Comment |
|------|--------|-------------|---|-----------|-----------|---------|
| 1.16 | ✓ | HSC_1 | Details 6ES7 214-1AG40-0XB0 | 1000 | --- | |
| 1.17 | ✓ | HSC_2 | Details 6ES7 214-1AG40-0XB0 | 1004 | --- | |
| 1.18 | ✓ | HSC_3 | Details 6ES7 214-1AG40-0XB0 | 1008 | --- | |
| 1.19 | ✓ | HSC_4 | Details 6ES7 214-1AG40-0XB0 | 1012 | --- | |
| 1.20 | ✓ | HSC_5 | Details 6ES7 214-1AG40-0XB0 | 1016 | --- | |
| 1.21 | ✓ | HSC_6 | Details 6ES7 214-1AG40-0XB0 | 1020 | --- | |
| 1.2 | ✓ | AI2_1 | Details 6ES7 214-1AG40-0XB0 | 64 | --- | |
| 1.1 | ✓ | DI14/DO10_1 | Details 6ES7 214-1AG40-0XB0 | 0 | 0 | |
| 1.32 | ✓ | Pulse_1 | Details 6ES7 214-1AG40-0XB0 | --- | 1000 | |

As you drill down, the module information page shows the path you have followed. You can click any link in this path to return to a higher level.



Sorting fields

When the list displays multiple modules, you can click the column header of a field to sort it either up or down by that field.

Note: This feature is not yet available for the Chinese Module Information page.

| Name | |
|-------------|-------------------------|
| AI2_1 | Details |
| DI14/DO10_1 | Details |
| HSC_1 | Details |
| HSC_2 | Details |
| HSC_3 | Details |
| HSC_4 | Details |
| HSC_5 | Details |
| HSC_6 | Details |
| Pulse_1 | Details |

Filtering the module information

You can filter any field in the module information list. From the drop-down list, select the field name for which you want to filter the data. Enter text in the associated text box and click the Filter link. The list updates to show you modules that correspond to your filtering criteria.

Module information: Identification tab

The identification tab displays the serial number and version numbers of the selected module.

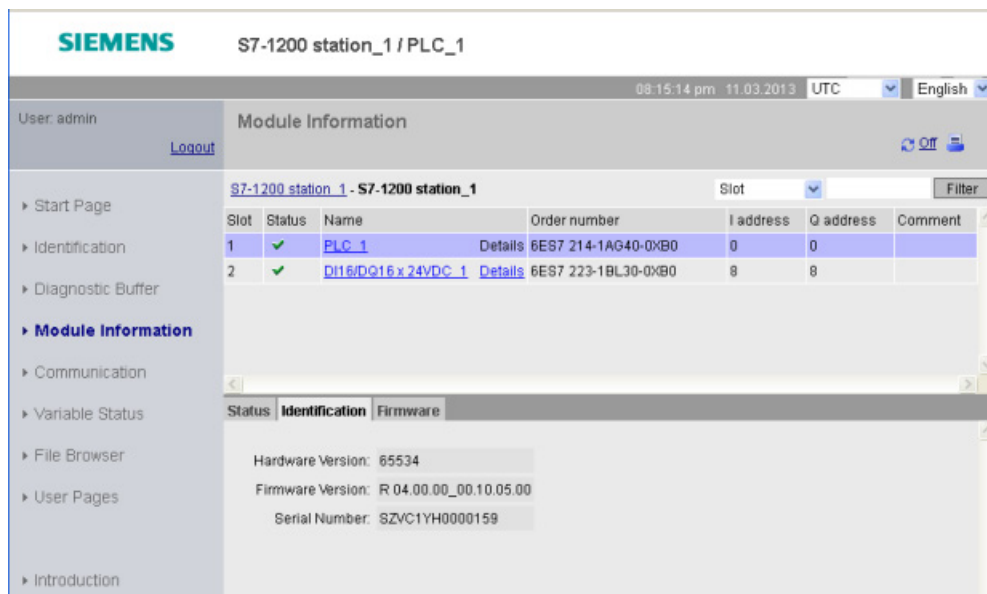

Module information: Firmware tab

The firmware tab of the module information page displays information about the firmware of the selected module. If you have the "perform firmware update" privilege (Page 604), you can also perform a firmware update of the CPU or other modules that support firmware update.

Note

You can only update S7-1200 CPUs of version 3.0 and higher with the Update Firmware feature.

The Web server uses the "https" protocol to perform the firmware update.

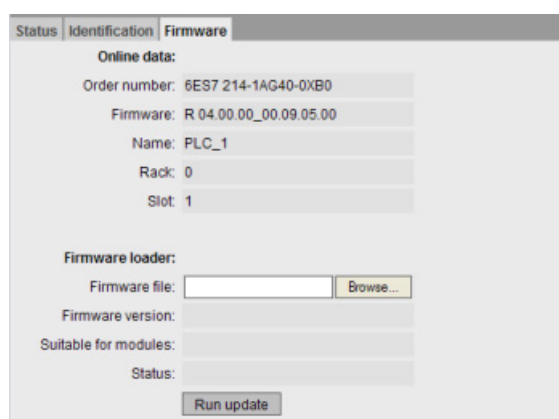

The CPU must be in STOP mode to perform a firmware update. When the CPU is in STOP mode, click the Browse button to navigate to and select a firmware file. Firmware updates are available on the customer support Web site (<http://support.automation.siemens.com>).

During the update, the page displays a message showing that the update is in progress. After the update completes, the page displays the order number and version number of the updated firmware. If you updated the firmware for the CPU or a signal board, the Web server restarts the CPU.

Note

You can also perform a firmware update from STEP 7 (Page 791), or by using a memory card (Page 133).

11.5.8 Communication

The communication page displays the parameters of the connected CPU, including the MAC address, the IP address, and IP settings of the CPU.

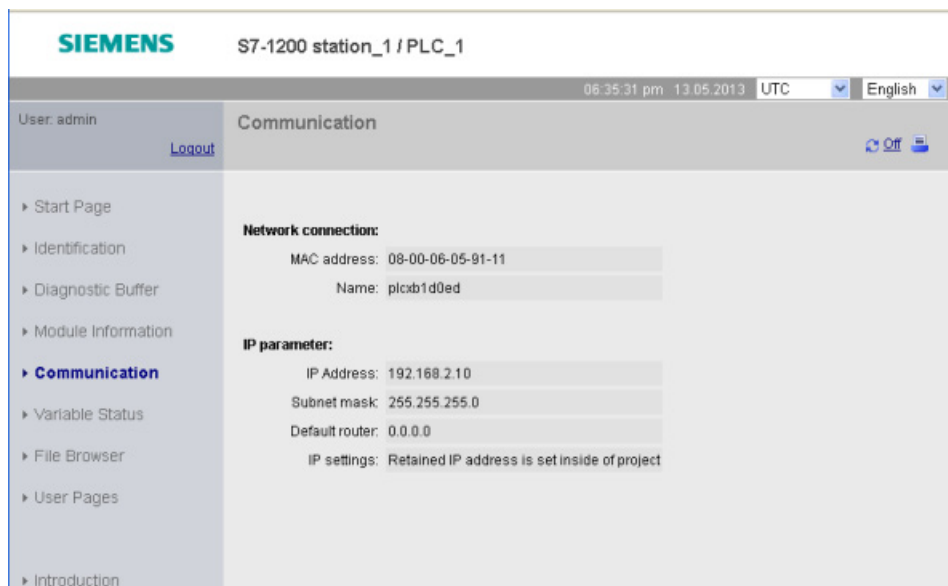

Viewing the Communication page requires the "query diagnostics" privilege.

11.5.9 Variable Status

The Variable Status page allows you to view any of the I/O or memory data in your CPU. You can enter a direct address (such as I0.0), a PLC tag name, or a tag from a specific data block. For data block tags, you enclose the data block name in double quotation marks. For each monitor value you can select a display format for the data. You can continue entering and specifying values until you have as many as you want within the limitations for the page. The monitor values show up automatically and refresh by default, unless you click the "Off" icon in the upper right area of the page. When refresh is disabled, you can click "On" to re-enable automatic refresh.

Viewing the Variable Status page requires the "read variable status" privilege.

If you login as a user with the "write variable status" privilege, you can also modify data values. Enter any values that you wish to set in the appropriate "Modify Value" field. Click the "Go" button beside a value to write that value to the CPU. You can also enter multiple values and click "Modify All Values" to write all of the values to the CPU. The buttons and column labels for modifying only appear if you have the "write variable status" privilege.

SIEMENS S7-1200 station_1 / PLC_1

User: admin Logout

08:15:14 pm 11.03.2013 UTC English

Variable Status

Enter the address of a tag here which you want to monitor/modify

| Address / Display Format | Monitor Value / Modify Value | Modify |
|--------------------------------------|------------------------------|--------|
| Q0.1 BOOL | true | Go |
| I0.1 BOOL | false | Go |
| Conveyor_speed DEC | 145 | Go |
| Mixer_On BOOL | false | Go |
| *Data block 1* location CHARACTER | 16#00000000 | Go |
| Tag_1 FLOATING POINT | 17.2 | Go |
| New variable BIN | | |

Monitor Value Modify All Values

If you leave the Variable Status page and return, the Variable Status page does not retain your entries. You can bookmark the page and return to the bookmark to see the same entries. If you do not bookmark the page, you must re-enter the variables.

Note

Be aware of the following issues when using the standard Variable Status page:

- Enclose all string modifications in single quotes.
- The Variable Status page cannot monitor or modify tags that contain any of the following characters: &, <, (, +, ,(comma), ., [,], \$, or %. For example, you cannot monitor the tag "Clock_2.5Hz".
- The Variable Status page does not allow you to modify a string longer than 198 characters.
- When using exponential notation to enter a value for a Real or LReal data type in the Variable Status page:
 - To enter a real-number value (Real or LReal) with a positive exponent (such as +3.402823e+25), enter the value in either of the following formats:
 - +3.402823e25
 - +3.402823e+25
 - To enter real-number value (Real or LReal) with a negative exponent (such as +3.402823e-25), enter the value as follows:
 - +3.402823e-25
 - Be sure that the mantissa portion of the real value in exponential notation includes a decimal point. Failure to include a decimal point results in the modification of the value to an unexpected integer value. For example, enter -1.0e8 rather than -1e8.
- The Variable Status page supports only 15 digits for an LReal value (regardless of the location of the decimal point). Entering more than 15 digits creates a rounding error.

Limitations on the Variable Status page:

- The maximum number of variable entries per page is 50.
- The maximum number of characters for the URL corresponding to the Variable Status page is 2083. You can see the URL that represents your current variable page in the address bar of your browser.
- For the character display format, the page displays hexadecimal values if the actual CPU values are not valid ASCII characters as interpreted by the browser.

Note

If a tag name displays special characters such that it is rejected as an entry on the Variable Status page, you can enclose the tag name in double quotation marks. In most cases, the Variable Status page will then recognize the tag name.

See also

Logging in and user privileges (Page 610)

11.5.10 File Browser

The File Browser page provides access to files in the internal load memory of the CPU or on the memory card (external load memory). The file browser page initially displays the root folder of the load memory, which contains the "DataLogs" and "Recipes" folders, but also displays any other folders that you might have created, if using a memory card.

The type of file access you have to the files and folders depends on your user privileges (Page 604). Any user with "read files" privileges can view the files and folders with the file browser. You cannot delete the DataLogs or Recipes folder regardless of your login privileges, but if you had made custom folders on the memory card, you can delete those folders if you have logged in as a user with "write/delete files" privileges.

Click a folder to access the individual files in the folder.

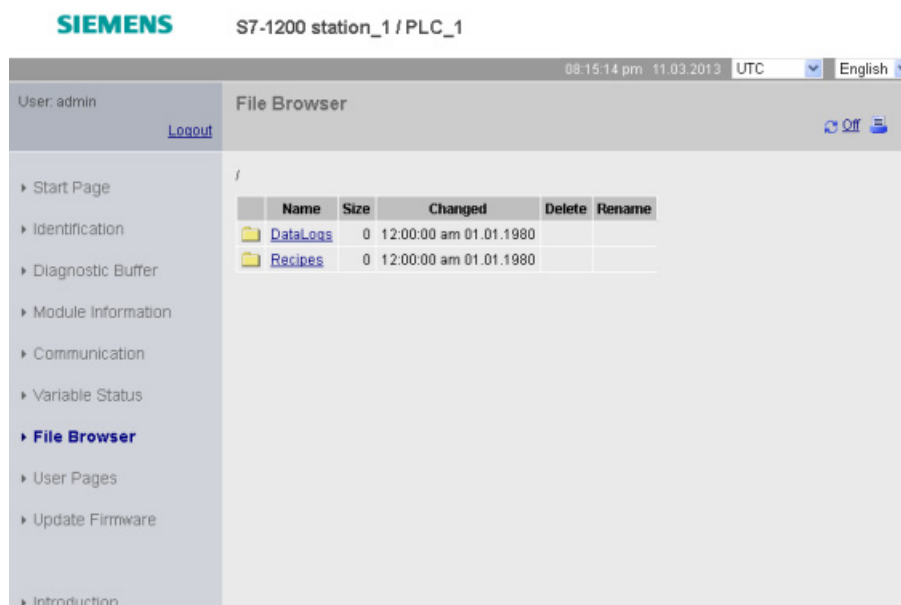

Data logs

From the "Data Logs" folder, you can open any of the data log files. If you have logged in with the "write/delete files" privilege (Page 604), you can also delete, rename, and upload files. The data log files are in comma-separated values (CSV) file format. You can save them to your computer or open them in Microsoft Excel (default) or another program. Note that if the PLC program has a data log open, you cannot delete it from the file browser page while it is open. Also, you cannot upload a data log file if the filename already exists.

Note

Time stamps for data logs

The Web server displays the time stamps for the data logs in either UTC time or PLC local time depending upon your selection at the top of the page.

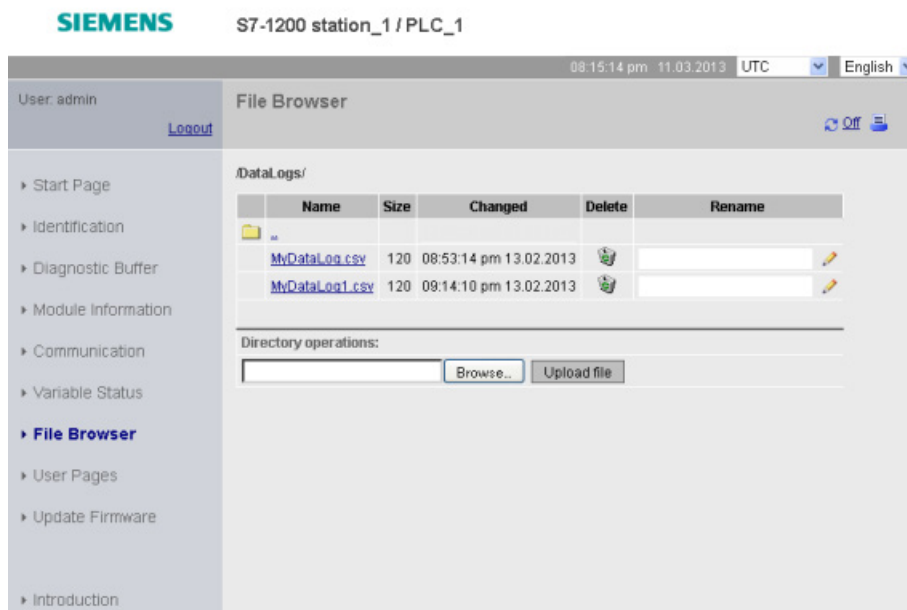

Note: The "Delete" and "Rename" options are not available if you are not logged in with the "write/delete files" privilege.

Note

The data log file is in USA/UK comma-separated values format (CSV). To open it in Excel on non-USA/UK systems, you must import it into Excel with specific settings (Page 667).

Recipe files

Like the data logs folder, the recipe folder displays any recipe files that are present in load memory. Recipe files are also in CSV format, and you can open them in Microsoft Excel, or another program. Like data logs, you must have modify privileges in order to delete, modify and save, rename or upload recipe files.

Uploading files and automatic page refresh

If you begin a file upload, the upload operation continues as long as you remain on the File Browser Web page. If you enabled automatic update to refresh the Web server pages every ten seconds, then whenever a page refresh occurs you see the incremental progress of the file upload operation. For example, if you are uploading a 2 MB file, you might see updates that show the file size in bytes at 2500, 5000, 10000, 15000, and 20000 as the file upload progresses.

If you leave the File Browser page before the upload completes, you do not get the complete file. When you return, the File Browser page displays the file name and the size of the file at the time that the upload stopped. You see no other indication that it is an incomplete file. To be sure you upload the complete file, remain on the File Browser page until the displayed file size reaches the actual size of the file.

Additional information

For information on programming with the data log instructions, and importing (Page 376) and exporting (Page 374) recipes, see the Recipes and Data logs (Page 369) chapter.

11.6 User-defined Web pages

The S7-1200 Web server also provides the means for you to create your own application-specific HTML pages that incorporate data from the PLC.

WARNING

Unauthorized access to the CPU through user-defined Web pages

Unauthorized access to the CPU through user-defined Web pages could disrupt process operation, which could result in death, severe personal injury and/or property damage.

Insecure coding of user-defined Web pages introduces security vulnerabilities such as cross-site scripting (XSS), code injection, and others.

Protect your S7-1200 CPU from unauthorized access by installing it in a secure fashion as outlined in the Operational Guidelines found on the Industrial Security Web site.

You create user-defined Web pages using the HTML editor of your choice and download them to the CPU where they are accessible from the standard Web page menu. This process involves several tasks:

- Creating HTML pages with an HTML editor, such as Microsoft Frontpage (Page 626)
- Including AWP commands in HTML comments in the HTML code (Page 627): The AWP commands are a fixed set of commands that Siemens provides for accessing CPU information.
- Configuring STEP 7 to read and process the HTML pages (Page 641)
- Generating blocks from the HTML pages (Page 641)
- Programming STEP 7 to control the use of the HTML pages (Page 642)
- Compiling and downloading the blocks to the CPU (Page 643)
- Accessing the user-defined Web pages from your PC (Page 644)

This process is illustrated below:

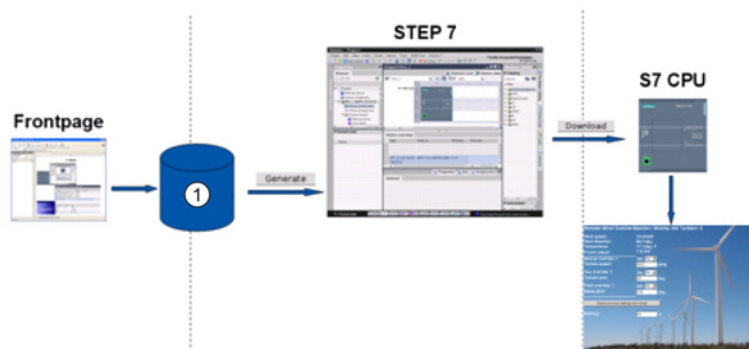

① HTML files with embedded AWP commands

See also

Industrial Security Web site (<http://www.siemens.com/industrialsecurity>)

11.6.1 Creating HTML pages

You can use the software package of your choice to create your own HTML pages for use with the Web server. Be sure that your HTML code is compliant to the HTML standards of the W3C (World Wide Web Consortium). STEP 7 does not perform any verification of your HTML syntax.

You can use a software package that lets you design in WYSIWYG or design layout mode, but you need to be able to edit your HTML code in pure HTML form. Most Web authoring tools provide this type of editing; otherwise, you can always use a simple text editor to edit the HTML code. Include the following line in your HTML page to set the charset for the page to UTF-8:

```
<meta http-equiv="content-type" content="text/html; charset=utf-8">
```

Also be sure to save the file from the editor in UTF-8 character encoding.

You use STEP 7 to compile everything in your HTML pages into STEP 7 data blocks. These data blocks consist of one control data block that directs the display of the Web pages and one or more fragment data blocks that contain the compiled Web pages. Be aware that extensive sets of HTML pages, particularly those with lots of images, require a significant amount of load memory space (Page 644) for the fragment DBs. If the internal load memory of your CPU is not sufficient for your user-defined Web pages, use a memory card (Page 124) to provide external load memory.

To program your HTML code to use data from the S7-1200, you include AWP commands (Page 627) as HTML comments. When finished, save your HTML pages to your PC and note the folder path where you save them.

Note

The file size limit for HTML files containing AWP command is 64 kilobytes. You must keep your file size below this limit.

Refreshing user-defined Web pages

User-defined Web pages do not automatically refresh. It is your choice whether to program the HTML to refresh the page or not. For pages that display PLC data, refreshing periodically keeps the data current. For HTML pages that serve as forms for data entry, refreshing can interfere with the user entering data. If you want your entire page to automatically refresh, you can add this line to your HTML header, where "10" is the number of seconds between refreshes:

```
<meta http-equiv="Refresh" content="10">
```

You can also use JavaScript or other HTML techniques to control page or data refreshing. For this, refer to documentation on HTML and JavaScript.

11.6.2 AWP commands supported by the S7-1200 Web server

The S7-1200 Web server provides AWP commands that you embed in your user-defined Web pages as HTML comments for the following purposes:

- Reading variables (Page 629)
- Writing variables (Page 630)
- Reading special variables (Page 631)
- Writing special variables (Page 633)
- Defining enum types (Page 635)
- Assigning variables to enum types (Page 635)
- Creating fragment data blocks (Page 637)

General syntax

Except for the command to read a variable, the AWP commands are of the following syntax:
`<!-- AWP_ <command name and parameters> -->`

You use the AWP commands in conjunction with typical HTML form commands to write to variables in the CPU.

The descriptions of the AWP commands in the following pages use the following conventions:

- Items enclosed in brackets [] are optional.
- Items enclosed in angle brackets < > are parameter values to be specified.
- Quotation marks are a literal part of the command. They must be present as indicated.
- Special characters in tag or data block names, depending on usage, must be escaped or enclosed in quotation marks (Page 639).

Use a text editor or HTML editing mode to insert AWP commands into your pages.

Note

Expected syntax of AWP commands

The space after "`<!--`" and the space before "`-->`" in the formulation of an AWP command are essential to proper compiling of the command. Omission of the space characters can cause the compiler to be unable to generate the proper code. The compiler does not display an error in this case.

AWP command summary

The details for using each AWP command are in the topics to follow, but here is a brief summary of the commands:

Reading variables

```
:=<Varname>:
```

Writing variables

```
<!-- AWP_In_Variable Name='<Varname1>' [Use='<Varname2>'] ... -->
```

This AWP command merely declares the variable in the Name clause to be writable. Your HTML code performs writes to the variable by name from `<input>`, `<select>`, or other HTML statements within an HTML form.

Reading special variables

```
<!-- AWP_Out_Variable Name='<Type>:<Name>' [Use='<Varname>'] -->
```

Writing special variables

```
<!-- AWP_In_Variable Name='<Type>:<Name>' [Use='<Varname>'] -->
```

Defining enum types

```
<!--
  AWP_Enum_Def Name='<Enum type name>' Values='<Value>, <Value>, ... '
  -->
```

Referencing enum types

```

<!-- AWP_Enum_Ref Name='<VarName>' Enum='<EnumType>' -->

Creating fragments
<!-- AWP_Start_Fragment Name='<Name>' [Type=<Type>] [ID=<id>] -->

Importing fragments
<!-- AWP_Import_Fragment Name='<Name>' -->

```

11.6.2.1 Reading variables

User-defined Web pages can read variables (PLC tags) from the CPU.

Syntax

```
:=<Varname>:
```

Parameters

| | |
|-----------|--|
| <Varname> | The variable to be read, which can be a PLC tag name from your STEP 7 program, a data block tag, I/O, or addressable memory. For memory or I/O addresses or alias names (Page 639), do not use quotation marks around the tag name. For PLC tags, use double quotation marks around the tag name. For data block tags, enclose the block name only in double quotation marks. The tag name is outside of the quotation marks. Note that you use the data block name and not a data block number. |
|-----------|--|

Examples

```

:="Conveyor_speed"::="My_Data_Block".flag1:
:=I0.0:
:=MW100:

```

Example reading an aliased variable

```

<!-- AWP_Out_Variable Name='flag1' Use='"My_Data_Block".flag1' -->
:=flag1:

```

Note

Defining alias names for PLC tags and data block tags is described in the topic Using an alias for a variable reference (Page 634).

If a tag name or data block name includes special characters, you must use additional quotation marks or escape characters as described in the topic Handling tag names that contain special characters (Page 639).

11.6.2.2 Writing variables

User-defined pages can write data to the CPU. This is accomplished by using an AWP command to identify a variable in the CPU to be writable from the HTML page. The variable must be specified by PLC tag name or data block tag name. You can declare multiple variable names in one statement. To write the data to the CPU, you use standard HTTP POST commands.

A typical usage is to design a form in your HTML page with text input fields or select list choices that correspond to writable CPU variables. As with all user-defined pages, you then generate the blocks from STEP 7 such that they are included in your STEP 7 program. When a user with privileges to modify variables subsequently accesses this page and types data into the input fields or selects a choice from a select list, the Web server converts the input to the appropriate data type for the variable, and writes the value to the variable in the CPU. Note that the name clause for HTML input fields and HTML select lists uses syntax typical for the name clause of the AWP_In_Variable command. Typically enclose the name in single quotation marks and if you reference a data block, enclose the data block name in double quotation marks.

For form management details, refer to documentation for HTML.

Syntax

```
<!-- AWP_In_Variable Name='<Varname1>' [Use='<Varname2>'] ... -->
```

Parameters

| | |
|------------|--|
| <Varname1> | <p>If no Use clause is provided, Varname1 is the variable to be written. It can be a PLC tag name from your STEP 7 program or a tag from a specific data block.</p> <p>If a Use clause is provided, Varname1 is an alternate name for the variable referenced in <Varname2> (Page 634). It is a local name within the HTML page.</p> |
| <Varname2> | <p>If a Use clause is provided, Varname2 is the variable to be written. It can be a PLC tag name from your STEP 7 program or a tag from a specific data block.</p> |

For both Name clauses and Use clauses, the complete name must be enclosed in single quotation marks. Within the single quotes, use double quotation marks around a PLC tag and double quotation marks around a data block name. The data block name is within the double quotes but not the data block tag name. Note that for data block tags, you use the name of the block and not a data block number.

Examples using HTML input field

```

<!-- AWP_In_Variable Name='\"Target_Level\"' -->
<form method="post">
<p>Input Target Level: <input name='\"Target_Level\"' type="text" />
</p>
</form>

<!-- AWP_In_Variable Name='\"Data_block_1\".Braking' -->
<form method="post">
<p>Braking: <input name='\"Data_block_1\".Braking' type="text" />
%</p>
</form>

<!-- AWP_In_Variable Name='\"Braking\"' Use='\"Data_block_1\".Braking' -
->
<form method="post">
<p>Braking: <input name='\"Braking\"' type="text" /> %</p>
</form>

```

Example using HTML select list

```

<!-- AWP_In_Variable Name='\"Data_block_1\".ManualOverrideEnable'-->
<form method="post">
<select name='\"Data_block_1\".ManualOverrideEnable'>
<option value='\"Data_block_1\".ManualOverrideEnable:> </option>
<option value=1>Yes</option>
<option value=0>No</option>
</select><input type="submit" value="Submit setting" /></form>

```

Note

Only a user with privileges to modify variables can write data to the CPU. The Web server ignores the commands if the user does not have modify privileges.

If a tag name or data block name includes special characters, you must use additional quotation marks or escape characters as described in the topic "Handling tag names that contain special characters (Page 639)".

11.6.2.3 Reading special variables

The Web server provides the ability to read values from the PLC to store in special variables in the HTTP response header. You might, for example, want to read a pathname from a PLC tag to redirect the URL to another location using the HEADER:Location special variable.

Syntax

```

<!-- AWP_Out_Variable Name='<Type>:<Name>' [Use='<Varname>'] -->

```

Parameters

| | |
|-----------|---|
| <Type> | The type of special variable, which is one of the following: HEADER COOKIE_VALUE COOKIE_EXPIRES |
| <Name> | Refer to HTTP documentation for a list of all the names of HEADER variables. A few examples are listed below: Status: response code Location: path for redirection Retry-After: how long service is expected to be unavailable to the requesting client For types COOKIE_VALUE and COOKIE_EXPIRES, <Name> is the name of a specific cookie. COOKIE_VALUE:name: value of the named cookie COOKIE_EXPIRES:name: expiration time in seconds of named cookie The Name clause must be enclosed in single or double quotation marks. If no Use clause is specified, the special variable name corresponds to a PLC tag name. Enclose the complete Name clause within single quotation marks and the PLC tag in double quotation marks. The special variable name and PLC tag name must match exactly. |
| <Varname> | Name of the PLC tag or data block tag into which the variable is to be read The Varname must be enclosed in single quotation marks. Within the single quotes, use double quotation marks around a PLC tag or data block name. The data block name is within the double quotes but not the data block tag name. Note that for data block tags, you use the name of the block and not a data block number. |

If a tag name or data block name includes special characters, you must use additional quotation marks or escape characters as described in the topic Handling tag names that contain special characters (Page 639).

Example: Reading a special variable with no Use clause

```
<!-- AWP_Out_Variable Name="HEADER:Status" -->
```

In this example, the HTTP special variable "HEADER:Status" receives the value of the PLC tag "HEADER:Status". The name in the PLC tag table must match the name of the special variable exactly if no Use clause is specified.

Example: Reading a special variable with a Use clause

```
<!-- AWP_Out_Variable Name='HEADER:Status' Use='Status' -->
```

In this example, the HTTP special variable "HEADER:Status" receives the value of the PLC tag "Status".

11.6.2.4 Writing special variables

The Web server provides the ability to write values to the CPU from special variables in the HTTP request header. For example, you can store information in STEP 7 about the cookie associated with a user-defined Web page, the user that is accessing a page, or header information. The Web server provides access to specific special variables that you can write to the CPU when logged in as a user with privileges to modify variables.

Syntax

```
<!-- AWP_In_Variable Name='<Type>:<Name>' [Use='<Varname>']-->
```

Parameters

| | |
|-----------|--|
| <Type> | The type of special variable and is one of the following: HEADER SERVER COOKIE_VALUE |
| <Name> | Specific variable within the types defined above, as shown in these examples: HEADER:Accept: content types that are acceptable HEADER:User-Agent: information about the user agent originating the request. SERVER:current_user_id: id of the current user; 0 if no user logged in SERVER:current_user_name: name of the current user COOKIE_VALUE:<name>: value of the named cookie Enclose the Name clause in single quotation marks. If no Use clause is specified, the special variable name corresponds to a PLC variable name. Enclose the complete Name clause within single quotation marks and the PLC tag in double quotation marks. The special variable name must match the PLC tag name exactly. Refer to HTTP documentation for a list of all the names of HEADER variables. |
| <Varname> | The variable name in your STEP 7 program into which you want to write the special variable, which can be a PLC tag name, or a data block tag. The Varname must be enclosed in single quotation marks. Within the single quotes, use double quotation marks around a PLC tag or data block name. The data block name is within the double quotes but not the data block tag name. Note that for data block tags, you use the name of the block and not a data block number. |

Examples

```
<!-- AWP_In_Variable Name='SERVER:current_user_id' -->
```

In this example, the Web page writes the value of the HTTP special variable "SERVER:current_user_id" to the PLC tag named "SERVER:current_user_id".

```
<!-- AWP_In_Variable Name=SERVER:current_user_id' Use='my_userid' -->
```

In this example, the Web page writes the value of the HTTP special variable "SERVER:current_user_id" to the PLC tag named "my_userid".

Note

Only a user with privileges to modify variables can write data to the CPU. The Web server ignores the commands if the user does not have modify privileges.

If a tag name or data block name includes special characters, you must use additional quotation marks or escape characters as described in the topic "Handling tag names that contain special characters (Page 639)".

11.6.2.5 Using an alias for a variable reference

You can use an alias in your user-defined Web page for an In_Variable or an Out_Variable. For example, you can use a different symbolic name in your HTML page than the one used in the CPU, or you can equate a variable in the CPU with a special variable. The AWP Use clause provides this capability.

Syntax

```
<-- AWP_In_Variable Name='<Varname1>' Use='<Varname2>' -->
<-- AWP_Out_Variable Name='<Varname1>' Use='<Varname2>' -->
```

Parameters

| | |
|------------|---|
| <Varname1> | The alias name or special variable name Varname1 must be enclosed in single or double quotation marks. |
| <Varname2> | Name of the PLC variable for which you want to assign an alias name. The variable can be a PLC tag, a data block tag, or a special variable. Varname2 must be enclosed in single quotation marks. Within the single quotes, use double quotation marks around a PLC tag, special variable, or data block name. The data block name is within the double quotes but not the data block tag name. Note that for data block tags, you use the name of the block and not a data block number. |

Examples

```
<-- AWP_In_Variable Name='SERVER:current_user_id'
Use=' "Data_Block_10".server_user' -->
```

In this example, the special variable SERVER:current_user_id is written to the tag "server_user" in data block "Data_Block_10".

```
<-- AWP_Out_Variable Name='Weight'
Use=' "Data_Block_10".Tank_data.Weight' -->
```

In this example, the value in data block structure member Data_Block_10.Tank_data.Weight can be referenced simply by "Weight" throughout the rest of the user-defined Web page.

```
<-- AWP_Out_Variable Name='Weight' Use=' "Raw_Milk_Tank_Weight"' -->
```

In this example, the value in the PLC tag "Raw_Milk_Tank_Weight" can be referenced simply by "Weight" throughout the rest of the user-defined Web page.

If a tag name or data block name includes special characters, you must use additional quotation marks or escape characters as described in the topic Handling tag names that contain special characters (Page 639).

11.6.2.6 Defining enum types

You can define enum types in your user-defined pages and assign the elements in an AWP command.

Syntax

```
<!-- AWP_Enum_Def Name='<Enum type name>' Values='<Value>,
<Value>,... ' -->
```

Parameters

| | |
|------------------|---|
| <Enum type name> | Name of the enumerated type, enclosed in single or double quotation marks. |
| <Value> | <constant>:<name> The constant indicates the numerical value for the enum type assignment. The total number is unbounded. The name is the value assigned to the enum element. |

Note that the entire string of enum value assignments is enclosed in single quotation marks, and each individual enum type element assignment is enclosed in double quotation marks. The scope of an enum type definition is global for the user-defined Web pages. If you have set up your user-defined Web pages in language folders (Page 656), the enum type definition is global for all pages in the language folder.

Example

```
<!-- AWP_Enum_Def Name='AlarmEnum' Values='0:"No alarms", 1:"Tank is
full", 2:"Tank is empty"' -->
```

11.6.2.7 Referencing CPU variables with an enum type

You can assign a variable in the CPU to an enum type. This variable can be used elsewhere in your user-defined Web page in a read operation (Page 629) or a write operation (Page 630). On a read operation, the Web server will replace the numerical value that is read from the CPU with the corresponding enum text value. On a write operation, the Web server will replace the text value with the integer value of the enumeration that corresponds to the text before writing the value to the CPU.

Syntax

```
<!-- AWP_In_Variable Name='<Varname>' Enum="<EnumType>" -->
<!-- AWP_Out_Variable Name='<Varname>' Enum="<EnumType>" -->
```

Parameters

| | |
|------------|--|
| <Varname> | Name of PLC tag or data block tag to associate with the enum type, or the name of the alias name for a PLC tag (Page 634) if declared. Varname must be enclosed in single quotation marks. Within the single quotes, use double quotation marks around a PLC tag or data block name. Note that for data block tags, you use the name of the block and not a data block number. The data block name is within the double quotes but not the data block tag name. |
| <EnumType> | Name of the enumerated type, which must be enclosed in single or double quotation marks |

The scope of an enum type reference is the current fragment.

Example usage in a variable read

```
<!-- AWP_Out_Variable Name='Alarm' Enum='AlarmEnum' -->...
<p>The current value of "Alarm" is :="Alarm":</p>
```

If the value of "Alarm" in the CPU is 2, the HTML page displays 'The current value of "Alarm" is Tank is empty' because the enum type definition (Page 635) assigns the text string "Tank is empty" to the numerical value 2.

Example usage in a variable write

```
<!-- AWP_Enum_Def Name='AlarmEnum' Values='0:"No alarms", 1:"Tank is full", 2:"Tank is empty"' -->
<!-- AWP_In_Variable Name='Alarm' Enum='AlarmEnum' -->...
<form method="POST">
<p><input type="hidden" name='Alarm' value="Tank is full" /></p>
<p><input type="submit" value='Set Tank is full' /><p>
</form>
```

Because the enum type definition (Page 635) assigns "Tank is full" to the numerical value 1, the value 1 is written to the PLC tag named "Alarm" in the CPU.

Note that the Name clause in the AWP_In_Variable declaration must correspond exactly to the Name clause in the AWP_Enum_Ref declaration.

Example usage in a variable write with use of an alias

```
<!-- AWP_Enum_Def Name='AlarmEnum' Values='0:"No alarms", 1:"Tank is full", 2:"Tank is empty"' -->
<!-- AWP_In_Variable Name='Alarm' Enum='AlarmEnum'
Use='Data_block_4.Motor1.Alarm'-->...
<form method="POST">
<p><input type="hidden" name='Alarm' value="Tank is full" /></p>
<p><input type="submit" value='Set Tank is full' /><p>
</form>
```

Because the enum type definition (Page 635) assigns "Tank is full" to the numerical value 1, the value 1 is written to the alias "Alarm" which corresponds to the PLC tag named "Motor1.Alarm" in data block "Data_Block_4" in the CPU.

If a tag name or data block name includes special characters, you must use additional quotation marks or escape characters as described in the topic Handling tag names that contain special characters (Page 639).

Note

Previous releases required a separate AWP_Enum_Ref declaration to associate a variable with a defined enum type. STEP 7 and the S7-1200 support existing code with AWP_Enum_Ref declarations; however, this command is no longer needed.

11.6.2.8 Creating fragments

STEP 7 converts and stores user-defined Web pages as a control DB and fragment DBs when you click "Generate blocks" in the CPU Properties for the Web server. You can set up specific fragments for specific pages or for sections of specific pages. You can identify these fragments by a name and number with the "Start_Fragment" AWP command. Everything in the page following the AWP_Start_Fragment command belongs to that fragment until another AWP_Start_Command is issued or until end of file is reached.

Syntax

```
<!-- AWP_Start_Fragment Name='<Name>'
[Type=<Type>] [ID=<id>] [Mode=<Mode>] -->
```

Parameters

| | |
|--------|--|
| <Name> | Text string: name of fragment DB Fragment names must begin with a letter or underscore and be comprised of letters, numeric digits, and underscores. The fragment name is a regular expression of the form: [a-zA-Z][a-zA-Z_0-9]* |
| <Type> | "manual" or "automatic" manual: The STEP 7 program must request this fragment and can respond accordingly. Operation of the fragment must be controlled with STEP 7 and the control DB variables. automatic: The Web server processes the fragment automatically. If you do not specify the type parameter, the default is "automatic". |
| <id> | Integer identification number. If you do not specify the ID parameter, the Web server assigns a number by default. For manual fragments, set the ID to a low number. The ID is the means by which the STEP 7 program controls a manual fragment. |
| <Mode> | "visible" or "hidden" visible: Contents of the fragment will display on the user-defined Web page. hidden: Contents of the fragment will not display on the user-defined Web page. If you do not specify the type parameter, the default is "visible". |

Manual fragments

If you create a manual fragment for a user-defined Web page or portion of a page, then your STEP 7 program must control when the fragment is sent. The STEP 7 program must set appropriate parameters in the control DB for a user-defined page under manual control and then call the WWW instruction with the control DB as modified. For understanding the structure of the control DB and how to manipulate individual pages and fragments, see the topic Advanced user-defined Web page control (Page 660).

11.6.2.9 Importing fragments

You can create a named fragment from a portion of your HTML code and then import that fragment elsewhere in your set of user-defined Web pages. For example, consider a set of user-defined Web pages that has a start page and then several other HTML pages accessible from links on the start page. Suppose each of the separate pages is to display the company logo on the page. You could implement this by creating a fragment (Page 637) that loads the image of the company logo. Each individual HTML page could then import this fragment to display the company logo. You use the AWP Import_Fragment command for this purpose. The HTML code for the fragment only exists in one fragment, but you can import this fragment DB as many times as necessary in as many Web pages as you choose.

Syntax

```
<!-- AWP_Import_Fragment Name='<Name>' -->
```

Parameters

| | |
|--------|---|
| <Name> | Text string: name of the fragment DB to be imported |
|--------|---|

Example

Excerpt from HTML code that creates a fragment to display an image:

```
<!-- AWP_Start_Fragment Name='My_company_logo' --><p></p>
```

Excerpt from HTML code in another .html file that imports the fragment that displays the logo image:

```
<!-- AWP_Import_Fragment Name='My_company_logo' -->
```

Both .html files (the one that creates the fragment and the one that imports it) are in the folder structure that you define when you configure the user-defined pages in STEP 7 (Page 641).

11.6.2.10 Combining definitions

When declaring variables for use in your user-defined Web pages, you can combine a variable declaration and an alias for the variable (Page 634). You can also declare multiple In_Variables in one statement and multiple Out_Variables in one statement.

Examples

```
<!-- AWP_In_Variable Name='Level', Name='Weight', Name='Temp'
-->
<!--! AWP_Out_Variable Name='HEADER:Status', Use='Status',
      Name='HEADER:Location', Use='Location',
      Name='COOKIE_VALUE:name', Use='my_cookie' -->
<!-- AWP_In_Variable Name='Alarm' Use='Data_block_10'.Alarm' -->
```

11.6.2.11 Handling tag names that contain special characters

When specifying variable names in user-defined Web pages, you must take special care if tag names contain characters that have special meanings.

Reading variables

You use the following syntax to read a variable (Page 629):
 :=<Varname>:

The following rules apply to reading variables:

- For variable names from the PLC tag table, enclose the tag name in double quotation marks.
- For variable names that are data block tags, enclose the data block name in double quotation marks. The tag is outside of the quotation marks.
- For variable names that are direct I/O addresses, memory addresses, or alias names, do not use quotation marks around the read variable.
- For tag names or data block tag names that contain a backslash, precede the backslash with another backslash.
- If a tag name or data block tag name contains a colon, less than sign, greater than sign, or ampersand define an alias that has no special characters for the read variable, and read the variable using the alias. Precede colons in tag names in a Use clause with a backslash.

Table 11- 1 Examples of Read variables

| Data block name | Tag name | Read command |
|-----------------|----------|---|
| n/a | ABC:DEF | <!--AWP_Out_Variable Name='special_tag' Use ='"ABC:DEF"' --> :=special tag: |
| n/a | T\ | :=T\\": |
| n/a | A\B\C:D | <!--AWP_Out_Variable Name='another_special_tag' Use='A \\B \'C :D"' --> :=another special tag: |
| n/a | a<b | <!--AWP_Out_Variable Name='a_less_than_b' Use='a<b"' --> :=a less than b: |
| Data_block_1 | Tag_1 | :=Data_block_1".Tag_1: |

| Data block name | Tag name | Read command |
|-----------------|----------|--|
| Data_block_1 | ABC:DEF | <code><!-- AWP_Out_Variable Name='special_tag' Use=' "Data_block_1".ABC\ :DEF' --> :=special_tag:</code> |
| DB A' B C D\$ E | Tag | <code>:= "DB A' B C D\$ E".Tag:</code> |
| DB:DB | Tag:Tag | <code><!--AWP_Out_Variable Name='my_tag' Use ='"DB:DB".Tag\ :Tag' --> :=my_tag:</code> |

Name and Use clauses

The AWP commands AWP_In_Variable, AWP_Out_Variable, AWP_Enum_Def, AWP_Enum_Ref, AWP_Start_Fragment and AWP_Import_Fragment have Name clauses. HTML form commands such as <input> and <select> also have name clauses. AWP_In_Variable and AWP_Out_Variable can additionally have Use clauses. Regardless of the command, the syntax for Name and Use clauses regarding the handling of special characters is the same:

- The text you provide for a Name or Use clause must be enclosed within single quotation marks. If the enclosed name is a PLC tag or Data block name, use single quotation marks for the full clause.
- Within a Name or Use clause, data block names and PLC tag names must be enclosed within double quotation marks.
- If a tag name or Data block name includes a single quote character or backslash, escape that character with a backslash. The backslash is the escape character in the AWP command compiler.

Table 11- 2 Examples of Name clauses

| Data block name | Tag name | Name clause options |
|-----------------|------------|--|
| n/a | ABC'DEF | <code>Name=' "ABC\ 'DEF" '</code> |
| n/a | A \B 'C :D | <code>Name=' "A \\B \'C :D" '</code> |
| Data_block_1 | Tag_1 | <code>Name=' "Data_block_1".Tag_1'</code> |
| Data_block_1 | ABC'DEF | <code>Name=' "Data_block_1".ABC\ 'DEF'</code> |
| Data_block_1 | A \B 'C :D | <code>Name=' "Data_block_1".A \\B \'C :D'</code> |
| DB A' B C D\$ E | Tag | <code>Name=' "DB A\ ' B C D\$ E".Tag'</code> |

Use clauses follow the same conventions as Name clauses.

Note

Regardless of what characters you use in your HTML page, set the charset of the HTML page to UTF-8 and save it from the editor with UTF-8 character encoding.

11.6.3 Configuring use of user-defined Web pages

To configure user-defined Web pages from STEP 7, follow these steps:

1. Select the CPU in the Device Configuration view.
2. Display the "Web server" properties in the inspector window for the CPU.

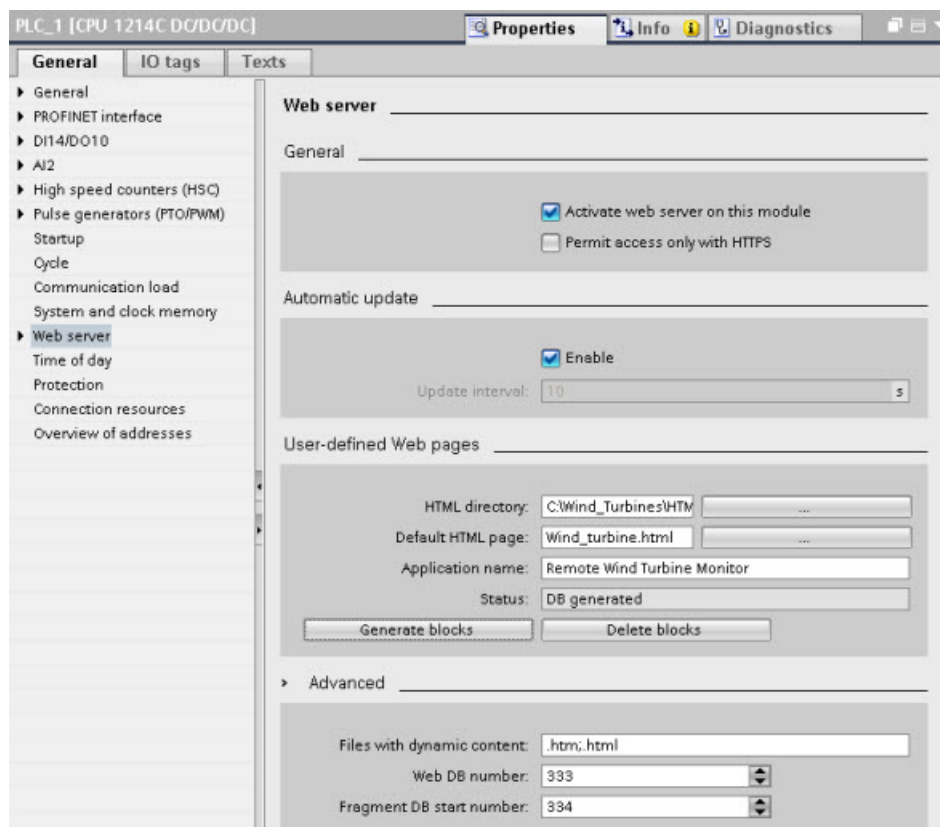

3. If not already selected, select the check box for "Activate Web server on this module".
4. Select the check box for "Permit access only with HTTPS" to ensure that the Web server uses encrypted communication and to increase the security of your Web-accessible CPU.
5. Enter or browse to the folder name on your PC where you saved the HTML default page (start page).
6. Enter the name of the default page.
7. Provide a name for your application (optional). The Web server uses the application name to further subcategorize or group web pages. When an application name exists, the URL will appear in the following format: `http://ww.xx.yy.zz/awp/<application name>/<pagename>.html`.

Avoid special characters in the application name. Some characters can cause the Web server to be unable to display the user-defined pages.

8. Specify filename extensions to be examined for the presence of AWP commands. By default, STEP 7 analyzes files with .htm, .html, or .js extensions. If you have additional file extensions, append them.

11.6 User-defined Web pages

9. Keep the default for the Web DB number, or enter a number of your choice. This is the DB number of the control DB that controls display of the Web pages.
- 10.Keep the default for the fragment DB start number, or enter a number of your choice. This is the first of the fragment DBs that contains the Web pages.

Generating program blocks

When you click the "Generate blocks" button, STEP 7 generates data blocks from the HTML pages in the HTML source directory that you specified and a control data block for the operation of your Web pages. You can set these attributes as needed for your application (Page 642). STEP 7 also generates a set of fragment data blocks to hold the representation of all of your HTML pages. When you generate the data blocks, STEP 7 updates the properties to display the control data block number, and the number of the first of the fragment data blocks. After you generate the data blocks, your user-defined Web pages are a part of your STEP 7 program. The blocks corresponding to these pages appear in the Web server folder, which is in the System blocks folder under Program blocks in the project navigation tree.

Deleting program blocks

To delete data blocks that you have previously generated, click the "Delete data blocks" button. STEP 7 deletes the control data block and all of the fragment data blocks from your project that correspond to user-defined Web pages.

11.6.4 Programming the WWW instruction for user-defined web pages

Your STEP 7 user program must include and execute the WWW instruction in order for the user-defined Web pages to be accessible from the standard Web pages. The control data block is the input parameter to the WWW instruction and specifies the content of the pages as represented in the fragment data blocks, as well as state and control information. STEP 7 creates the control data block when you click the "Create blocks" button in the configuration of user-defined Web pages (Page 641).

Programming the WWW instruction

The STEP 7 program must execute the WWW instruction for the user-defined Web pages to be accessible from the standard Web pages. You might want the user-defined Web pages available only under certain circumstances as dictated by your application requirements and preferences. In this case, your program logic can control when to call the WWW instruction.

Table 11- 3 WWW instruction

| LAD / FBD | SCL | Description |
|-----------|---|---|
| | <pre>ret_val := WWW(ctrl_db:=_uint_in_);</pre> | Provides access to user-defined Web pages from standard Web pages |

You must provide the control data block input parameter (CTRL_DB) which corresponds to the integer DB number of the control DB. You can find this control DB block number (called Web DB Number) in the Web Server properties of the CPU after you create the blocks for the user-defined Web pages. Enter the integer DB number as the CTRL_DB parameter of the WWW instruction. The return value (RET_VAL) contains the function result. Note that the WWW instruction executes asynchronously and that the RET_VAL output might have an initial value of 0 although an error can occur later. The program can check the state of the control DB to ensure that the application started successfully, or check RET_VAL with a subsequent call to WWW.

Table 11-4 Return value

| RET_VAL | Description |
|---------|---|
| 0 | No error |
| 16#00yx | x: The request represented by the respective bit is in the waiting state: x=1: request 0 x=2: request 1 x=4: request 2 x=8: request 3 The x values can be logically OR-ed to represent waiting states of multiple requests. If x = 6, for example, requests 1 and 2 are waiting. y: 0: no error; 1: error exists and "last_error" has been set in the control DB (Page 660) |
| 16#803a | The control DB is not loaded. |
| 16#8081 | The control DB is of the wrong type, format, or version. |
| 16#80C1 | No resources are available to initialize the web application. |

Usage of the Control DB

STEP 7 creates the control data block when you click "Generate blocks" and displays the control DB number in the User-defined Web pages properties. You can find the control DB as well in the Program blocks folder in the project navigation tree.

Typically, your STEP 7 program uses the control DB directly as created by the "Generate blocks" process with no additional manipulation. However, the STEP 7 user program can set global commands in the control DB to deactivate the web server or to subsequently re-enable it. Also, for user-defined pages that you create as manual fragment DBs (Page 641), the STEP 7 user program must control the behavior of these pages through a request table in the control DB. For information on these advanced tasks, see the topic Advanced user-defined Web page control (Page 660).

11.6.5 Downloading the program blocks to the CPU

After you have generated the blocks for user-defined Web pages, they are part of your STEP 7 program just like any other program blocks. You follow the normal process to download the program blocks to the CPU. Note that you can only download user-defined Web page program blocks when the CPU is in STOP mode.

11.6.6 Accessing the user-defined Web pages

You access your user-defined Web pages from the standard Web pages (Page 606). The standard Web pages display a link for "User Pages" on the left side menu where the links to the other pages appear. The mobile device navigation page also provides a link to "User Pages". When you click the "User Pages" link, your Web browser goes to the page that provides a link to your default page. From within the user-defined pages, navigation is according to how you designed your specific pages.

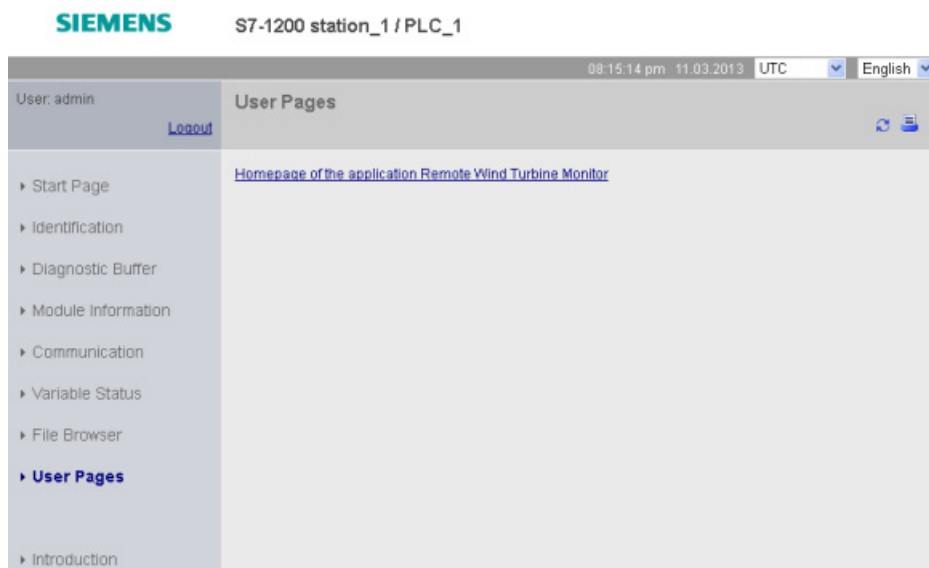

11.6.7 Constraints specific to user-defined Web pages

The constraints for standard Web pages (Page 664) also apply to user-defined Web pages. In addition, user-defined Web pages have some specific considerations.

Load memory space

Your user-defined Web pages become data blocks when you click "Generate blocks", which require load memory space. If you have a memory card installed, you have up to the capacity of your memory card as external load memory space for the user-defined Web pages.

If you do not have a memory card installed, these blocks take up internal load memory space, which is limited according to your CPU model.

You can check the amount of load memory space that is used and the amount that is available from the Online and Diagnostic tools in STEP 7. You can also look at the properties for the individual blocks that STEP 7 generates from your user-defined Web pages and see the load memory consumption.

Note

If you need to reduce the space required for your user-defined Web pages, reduce your use of images if applicable.

11.6.8 Example of a user-defined web page

11.6.8.1 Web page for monitoring and controlling a wind turbine

As an example of a user-defined Web page, consider a Web page that is used to remotely monitor and control a wind turbine:

Remote Wind Turbine Monitor: Turbine #5

| | |
|---------------------|-------------|
| Wind speed: | 7.5 km/h |
| Wind direction: | 23.5 deg. |
| Temperature: | 17.2 deg. C |
| Power output: | 1000 KW |
| Manual override: On | Set: Yes |
| Turbine speed: | 15 RPM |
| Yaw override: On | Set: Yes |
| Turbine yaw: | 52 deg. |
| Pitch override: On | Set: Yes |
| Blade pitch: | 4.5 deg. |

Submit override settings and values

Braking: 25 %

Description

In this application, each wind turbine in a wind turbine farm is equipped with an S7-1200 for control of the turbine. Within the STEP 7 program, each wind turbine has a data block with data specific to that wind turbine.

The user-defined Web page provides remote turbine access from a PC. A user can connect to standard web pages of the CPU of a particular wind turbine and access the user-defined "Remote Wind Turbine Monitor" Web page to see the data for that turbine. A user with privileges to modify variables can also put the turbine in manual mode and control the variables for turbine speed, yaw, and pitch from the Web page. A user with privileges to modify variables can also set a braking value regardless of whether the turbine is under manual or automatic control.

The STEP 7 program would check the Boolean values for overriding automatic control, and if set, would use the user-entered values for turbine speed, yaw, and pitch. Otherwise, the program would ignore these values.

Files used

This user-defined Web page example consists of three files:

- **Wind_turbine.html:** This is the HTML page that implements the display shown above, using AWP commands to access controller data.
- **Wind_turbine.css:** This is the cascading style sheet that contains formatting styles for the HTML page. Use of a cascading style sheet is optional, but it can simplify the HTML page development.
- **Wind_turbine.jpg:** This is the background image that the HTML page uses. Use of images in user-defined Web pages is, of course, optional, and does require additional space in the CPU.

These files are not provided with your installation, but are described as an example.

Implementation

The HTML page uses AWP commands to read values from the PLC (Page 629) for the display fields and to write values to the PLC (Page 630) for data coming from user input. This page also uses AWP commands for enum type definition (Page 635) and reference (Page 635) for handling ON/OFF settings.

The first part of the page displays a header line that includes the wind turbine number.

Remote Wind Turbine Monitor: Turbine #5

The next part of the page displays atmospheric conditions at the wind turbine. I/O at the turbine site provide the wind speed, wind direction, and current temperature.

| | |
|-----------------|-------------|
| Wind speed: | 7.5 km/h |
| Wind direction: | 23.5 deg. |
| Temperature: | 17.2 deg. C |

Next, the page displays the power output of the turbine as read from the S7-1200.

| | |
|---------------|---------|
| Power output: | 1000 KW |
|---------------|---------|

The following sections allow for manual control of the turbine, overriding the normal automatic control by the S7-1200. These types are as follows:

- Manual override: enables manual override of the turbine. The STEP 7 user program requires that the manual override setting be true before enabling the use of any of the manual settings for turbine speed, or yaw or pitch.

| | |
|---------------------|----------|
| Manual override: On | Set: Yes |
| Turbine speed: | 15 RPM |

- Yaw override: enables manual override of the yaw setting, and a manual setting for the yaw. The STEP 7 user program requires that both manual override and yaw override be true in order to apply the yaw setting.

| | |
|------------------|----------|
| Yaw override: On | Set: Yes |
| Turbine yaw: | 52 deg. |

- Pitch override: enables manual override of the pitch of the blades. The STEP 7 user program requires that both manual override and pitch override be true in order to apply the blade pitch setting.

| | |
|--------------------|----------|
| Pitch override: On | Set: Yes |
| Blade pitch: | 4.5 deg. |

The HTML page includes a submit button to post the override settings to the controller.

| |
|-------------------------------------|
| Submit override settings and values |
|-------------------------------------|

The braking user input field provides a manual setting for a braking percentage. The STEP 7 user program does not require manual override to accept a braking value.

| | |
|----------|------|
| Braking: | 25 % |
|----------|------|

In addition, the HTML page uses an AWP command to write the special variable (Page 633) that contains the user ID of the user that is accessing the page to a tag in the PLC tag table.

11.6.8.2 Reading and displaying controller data

The "Remote Wind Turbine Monitor" HTML page uses numerous AWP commands for reading data from the controller (Page 629) and displaying it on the page. For example, consider the HTML code for displaying the power output as shown in this portion of the example Web page:

| | |
|---------------|---------|
| Power output: | 1000 KW |
|---------------|---------|

Sample HTML code

The following excerpt from the "Remote Wind Turbine Monitor" HTML page displays the text "Power Output:" in the left cell of a table row and reads the variable for the power output and displays it in the right cell of the table row along with the text abbreviation for kilowatts, kW.

The AWP command := "Data_block_1".PowerOutput: performs the read operation. Note that data blocks are referenced by name, not by data block number (that is, "Data_block_1" and not "DB1").

```
<tr style="height:2%;">
<td>
<p>Power output:</p>
</td>
<td>
<p style="margin-bottom:5px;"> := "Data_block_1".PowerOutput: kW</p>
</td>
</tr>
```

11.6.8.3 Using an enum type

The "Remote Wind Turbine Monitor" HTML page uses enum types for the three instances where HTML page displays "ON" or "OFF" for a Boolean value, and for where the user sets a Boolean value. The enum type for "ON" results in a value of 1, and the enum type for "OFF" results in a value of 0. For example, consider the HTML code for reading and writing the Manual Override Enable setting in "Data_block_1".ManualOverrideEnable value using an enum type:

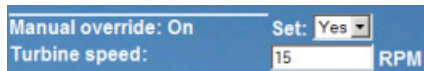

Sample HTML code

The following excerpts from the "Remote Wind Turbine Monitor" HTML page show how to declare an enum type called "OverrideStatus" with values of "Off" and "On" for 0 and 1, and then setting an enum type reference to OverrideStatus for the ManualOverrideEnable Boolean tag in the data block named "Data_block_1".

```
<!-- AWP_In_Variable Name="Data_block_1".ManualOverrideEnable'
Enum="OverrideStatus" -->

<!-- AWP_Enum_Def Name="OverrideStatus" Values='0:"Off",1:"On"' -->
```

Where the HTML page includes a display field in a table cell for the current state of ManualOverrideEnable, it uses just a normal read variable command, but with the use of the previously declared and referenced enum type, the page displays "Off" or "On" rather than 0 or 1.

```
<td style="width:24%; border-top-style: Solid; border-top-width:
2px; border-top-color: #ffffff;">
<p>Manual override: := "Data_block_1".ManualOverrideEnable:</p>
</td>
```

The HTML page includes a drop-down select list for the user to change the value of ManualOverrideEnable. The select list uses the text "Yes" and "No" to display in the select lists. With the use of the enum type, "Yes" is correlated to the value "On" of the enum type, and "No" is correlated to the value "Off". The empty selection leaves the value of ManualOverrideEnable as it is.

```
<select name=' "Data_block_1".ManualOverrideEnable'>
<option value=' : "Data_block_1".ManualOverrideEnable: ' > </option>
<option value="On">Yes</option>
<option selected value="Off">No</option>
</select>
```

The select list is included within a form on the HTML page. When the user clicks the submit button, the page posts the form, which writes a value of "1" to the Boolean ManualOverrideEnable in Data_block_1 if the user had selected "Yes", or "0" if the user had selected "No".

11.6.8.4 Writing user input to the controller

The "Remote Wind Turbine Monitor" HTML page includes several AWP commands for writing data to the controller (Page 630). The HTML page declares AWP_In_Variables for Boolean variables so that a user with privileges to modify variables can put the wind turbine under manual control and enable manual override for the turbine speed, yaw override, and/or blade pitch override. The page also uses AWP_In_Variables to allow a user with privileges to modify variables to subsequently set floating-point values for the turbine speed, yaw, pitch, and braking percentage. The page uses an HTTP form post command to write the AWP_In_Variables to the controller.

For example, consider the HTML code for manually setting the braking value:



Sample HTML code

The following excerpt from the "Remote Wind Turbine Monitor" HTML page first declares an AWP_In_Variable for "Data_block_1" that enables the HTML page to write to any tags in the data block "Data_block_1". The page displays the text "Braking:" in the left cell of a table row. In the right cell of the table row is the field that accepts user input for the "Braking" tag of "Data_block_1". This user input value is within an HTML form that uses the HTTP method "POST" to post the entered text data to the CPU. The page then reads the actual braking value from the controller and displays it in the data entry field.

A user with privileges to modify variables can subsequently use this page to write a braking value to the data block in the CPU that controls braking.

```
<!-- AWP_In_Variable Name=' "Data_block_1"' -->
...
<tr style="vertical-align: top; height: 2%;">
<td style="width: 22%;"><p>Braking:</p></td>
<td>
<form method="POST">
<p><input name=' "Data_block_1".Braking' size="10" type="text"> %</p>
</form>
</td>
</tr>
```

Note

Note that if a user-defined page has a data entry field for a writable data block tag that is a string data type, the user must enclose the string in single quotation marks when entering the string value in the field.

Note

Note that if you declare an entire data block in an AWP_In_Variable declaration such as `<!-- AWP_In_Variable Name="Data_block_1" -->`, then every tag within that data block can be written from the user-defined Web page. Use this when you intend for all of the tags in a data block to be writable. Otherwise, if you only want specific data block tags to be writable from the user-defined Web page, declare it specifically with a declaration such as `<!-- AWP_In_Variable Name="Data_block_1".Braking' -->`

11.6.8.5 Writing a special variable

The "Remote Wind Turbine Monitor" Web page writes the special variable `SERVER:current_user_id` to a PLC tag in the CPU, providing that the user has modify privileges. In this case, the PLC tag value contains the user ID of the user who is accessing the "Remote Wind Turbine Monitor" Web page.

The Web page writes the special variable to the PLC and requires no user interface.

Sample HTML code

```
<!-- AWP_In_Variable Name="SERVER:current_user_id" Use="User_ID"-->
```

11.6.8.6 Reference: HTML listing of remote wind turbine monitor Web page**Wind_turbine.html**

```
<!DOCTYPE HTML PUBLIC "-//W3C//DTD HTML 4.01 Transitional//EN"
"http://www.w3.org/TR/html4/loose.dtd">
<!--
This test program simulates a Web page to monitor and control a Wind
Turbine
Required PLC tags and Data Block Tags in STEP 7:

PLC Tag:
User_ID: Int

Data Blocks:
Data_block_1

Tags in Data_Block_1:

TurbineNumber: Int
WindSpeed: Real
WindDirection: Real
```

```

Temperature: Real
PowerOutput: Real
ManualOverrideEnable: Bool
TurbineSpeed: Real
YawOverride: Bool
Yaw: Real
PitchOverride: Bool
Pitch: Real
Braking: Real

```

The user-defined Web page displays current values for the PLC data, and provides a select list to set the three Booleans using an enumerated type assignment. The "Submit" button posts the selected Boolean values as well as the data entry fields for TurbineSpeed, Yaw, and Pitch. The value for Braking can be set without use of the "Submit" button.

No actual STEP 7 program is required to use this page. Theoretically, the STEP 7 program would only act on the values of TurbineSpeed, Yaw, and Pitch, if the associated Booleans were set. The only STEP 7 requirement is to call the WWW instruction with the DB number of the generated data blocks for this page.

```

-->
<!-- AWP_In_Variable Name='"Data_block_1"' -->
<!-- AWP_In_Variable Name='"Data_block_1".ManualOverrideEnable'
Enum="OverrideStatus" -->
<!-- AWP_In_Variable Name='"Data_block_1".PitchOverride'
Enum="OverrideStatus" -->
<!-- AWP_In_Variable Name='"Data_block_1".YawOverride'
Enum="OverrideStatus" -->
<!-- AWP_In_Variable Name="SERVER:current_user_id" Use="User_ID"-->
<!-- AWP_Enum_Def Name="OverrideStatus" Values='0:"Off",1:"On"' -->

```

```

<html>
<head>
<meta http-equiv="content-type" content="text/html; charset=utf-8">
<link rel="stylesheet" href="Wind_turbine.css">
<title>Remote Wind Turbine Monitor</title>
</head>
<body>
<table cellpadding="0" cellspacing="2">
<tr style="height: 2%;">
<td colspan="2">
<h2>Remote Wind Turbine Monitor: Turbine
#:="Data_block_1".TurbineNumber:</h2>
</td>

<tr style="height: 2%;">
<td style="width: 25%;"><p>Wind
speed:</p></td>
<td><p> :="Data_block_1".WindSpeed: km/h</p></td>
</tr>

<tr style="height: 2%;">
<td style="width: 25%;"><p>Wind direction:</p></td>
<td><p> :="Data_block_1".WindDirection: deg.</p></td>
</tr>

```

```

<tr style="height: 2%;"><td style="width:
25%;"><p>Temperature:</p></td>
<td><p> := "Data_block_1".Temperature: deg. C</p></td>
</tr>

<tr style="height: 2%;">
<td style="width: 25%;"><p>Power output:</p></td>
<td><p style="margin-bottom:5px;"> := "Data_block_1".PowerOutput:
kW</p>
</td>
</tr>

<form method="POST" action="">
<tr style="height: 2%;" >
<td style="width=25%; border-top-style: Solid; border-top-width:
2px; border-top-color: #ffffff;">
<p>Manual override: := "Data_block_1".ManualOverrideEnable:</p>
</td>
<td class="Text">Set:

<select name=' "Data_block_1".ManualOverrideEnable'>
<option value=' := "Data_block_1".ManualOverrideEnable:'> </option>
<option value="On">Yes</option>
<option value="Off">No</option>
</select>

</td>
</tr>

<tr style="vertical-align: top; height: 2%;"><td style="width:
25%;"><p>Turbine speed:</p></td>
<td>
<p style="margin-bottom:5px;"><input
name=' "Data_block_1".TurbineSpeed' size="10"
value=' := "Data_block_1".TurbineSpeed:' type="text"> RPM</p>
</td>
</tr>

<tr style="vertical-align: top; height: 2%;">
<td style="width: 25%;">
<p>Yaw override: := "Data_block_1".YawOverride: </p>
</td>
<td class="Text">Set:

<select name=' "Data_block_1".YawOverride'>
<option value=' := "Data_block_1".YawOverride:'> </option>
<option value="On">Yes</option>
<option value="Off">No</option>
</select>

</td>
</tr>

<tr style="vertical-align: top; height: 2%;">

```



```

<td style="width: 25%;">
<p>Turbine yaw:</p>
</td>
<td>
<p style="margin-bottom:5px;"><input name=' "Data_block_1".Yaw'
size="10" value=' :="Data_block_1".Yaw:' type="text"> deg.</p>
</td>
</tr>

<tr style="vertical-align: top; height: 2%;">
<td style="width: 25%;">
<p>Pitch override: :="Data_block_1".PitchOverride: </p>
</td>
<td class="Text">Set:

<select name=' "Data_block_1".PitchOverride'>
<option value=' :="Data_block_1".PitchOverride:'> </option>
<option value="On">Yes</option>
<option value="Off">No</option>
</select>

</td>
</tr>

<tr style="vertical-align: top; height: 2%;">
<td style="width=25%; border-bottom-style: Solid; border-bottom-
width: 2px; border-bottom-color: #ffffff;">
<p>Blade pitch:</p>
</td>
<td>
<p style="margin-bottom:5px;"><input name=' "Data_block_1".Pitch'
size="10" value=' :="Data_block_1".Pitch:' type="text"> deg.</p>
</td>

</tr>
<tr style="height: 2%;">
<td colspan="2">
<input type="submit" value="Submit override settings and values">
</td>
</tr>
</form>

<tr style="vertical-align: top; height: 2%;">
<td style="width: 25%;"><p>Braking:</p></td>
<td>
<form method="POST" action="">
<p> <input name=' "Data_block_1".Braking' size="10"
value=' :="Data_block_1".Braking:' type="text"> %</p>
</form>
</td>
</tr>
<tr><td></td></tr>

```

```
</table>
</body>
</html>
```

Wind_turbine.css

```
BODY {
  background-image: url('./Wind_turbine.jpg');
  background-position: 0% 0%;
  background-repeat: no-repeat;
  background-size: cover;
}
H2 {
  font-family: Arial;
  font-weight: bold;
  font-size: 14.0pt;
  color: #FFFFFF;
  margin-top:0px;
  margin-bottom:10px;
}
P {
  font-family: Arial;
  font-weight: bold;
  color: #FFFFFF;
  font-size: 12.0pt;
  margin-top:0px;
  margin-bottom:0px;
}
TD.Text {
  font-family: Arial;
  font-weight: bold;
  color: #FFFFFF;
  font-size: 12.0pt;
  margin-top:0px;
  margin-bottom:0px;
}
```

11.6.8.7 Configuration in STEP 7 of the example Web page

To include the "Remote Wind Turbine Monitor" HTML page as a user-defined Web page for the S7-1200, you configure the data about the HTML page in STEP 7 and create data blocks from the HTML page.

Access the CPU Properties for the S7-1200 that controls the wind turbine, and enter the configuration information in the User-defined web pages properties of the Web Server:

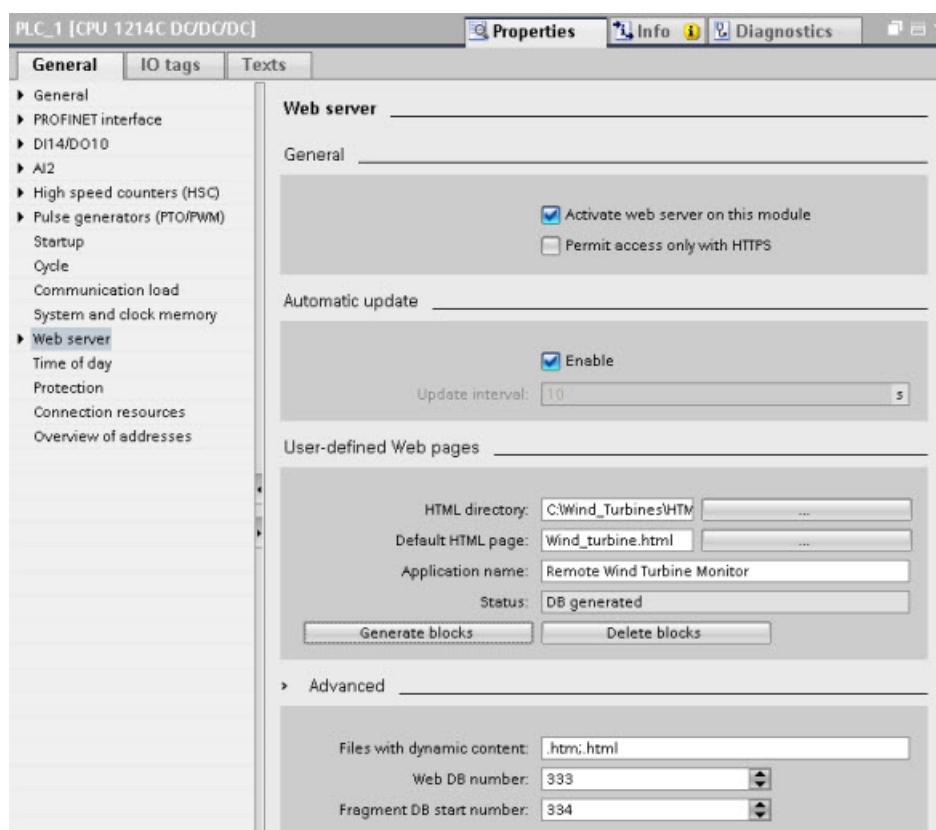

Configuration fields

- **HTML directory:** This field specifies the fully-qualified pathname to the folder where the default page (home page or start page) is located on the computer. The "..." button allows you to browse to the folder that you need.
- **Default HTML page:** This field specifies the filename of the default page or home page of the HTML application. The "..." button allows you to select the file that you need. For this example, WindTurbine.html is the default HTML page. The Remote Wind Turbine Monitor example only consists of a single page, but in other user-defined applications the default page can call up additional pages from links on the default page. Within the HTML code, the default page must reference other pages relative to the HTML source folder.
- **Application name:** This optional field contains the name that the Web browser includes in the address field when displaying the page. For this example, it is "Remote Wind Turbine Monitor", but you can use any name.

No other fields require configuration.

Final steps

To use the Remote Wind Turbine Monitor as configured, generate the blocks, program the WWW instruction (Page 642) with the number of the generated control DB as an input parameter, download the program blocks, and put the CPU in run mode.

When an operator subsequently accesses the standard Web pages for the S7-1200 that controls the wind turbine, the "Remote Wind Turbine Monitor" Web page is accessible from the "User Pages" link on the navigation bar. This page now provides the means to monitor and control the wind turbine.

11.6.9 Setting up user-defined Web pages in multiple languages

The Web server provides the means for you to provide user-defined Web pages in the following languages:

- German (de)
- English (en)
- Spanish (es)
- French (fr)
- Italian (it)
- Simplified Chinese (zh)

You do this by setting up your HTML pages in a folder structure (Page 656) that corresponds to the languages and by setting a specific cookie named "siemens_automation_language" from your pages (Page 657). The Web server responds to this cookie, and switches to the default page in the corresponding language folder.

11.6.9.1 Creating the folder structure

To provide user-defined Web pages in multiple languages, you set up a folder structure under your HTML directory. The two-letter folder names are specific and must be named as shown below:

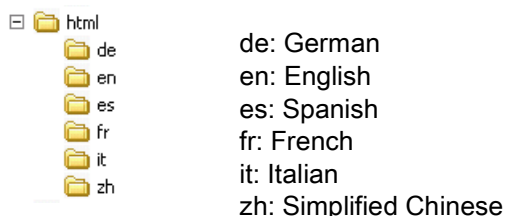

At the same level, you can also include any other folders that your pages need, for example, folders for images or scripts.

You can include any subset of the language folders. You do not have to include all six languages. Within the language folders, you create and program your HTML pages in the appropriate language.

11.6.9.2 Programming the language switch

The Web server performs switching between languages through the use of a cookie named "siemens_automation_language". This is a cookie defined and set in the HTML pages, and interpreted by the Web server to display a page in the appropriate language from the language folder of the same name. The HTML page must include a JavaScript to set this cookie to one of the pre-defined language identifiers: "de", "en", "es", "fr", "it", or "zh".

For example, if the HTML page sets the cookie to "de", the Web server switches to the "de" folder and displays the page with the default HTML page name as defined in the STEP 7 configuration (Page 659).

Example

The following example uses a default HTML page named "langswitch.html" in each of the language folders. Also in the HTML directory is a folder named "script". The script folder includes a JavaScript file named "lang.js". Each langswitch.html page uses this JavaScript to set the language cookie, "siemens_automation_language".

HTML for "langswitch.html" in "en" folder

The header of the HTML page sets the language to English, sets the character set to UTF-8, and sets the path to the JavaScript file lang.js.

```
<!DOCTYPE HTML PUBLIC "-//W3C//DTD HTML 4.01 Transitional//EN">
<html>
<head>
<meta http-equiv="Content-Language" content="en">
<meta http-equiv="Content-Type" content="text/html; charset=utf-8">
<title>Language switching english page</title>
<script type="text/javascript" src="script/lang.js" ></script>
```

The body of the file uses a select list for the user to select between German and English. English ("en") is pre-selected for the language. When the user changes the language, the page calls the DoLocalLanguageChange() JavaScript function with the value of the selected option.

```
<!-- Language Selection -->
<table>
  <tr>
    <td align="right" valign="top" nowrap>
      <!-- change language immediately on selection change -->
      <select name="Language"
        onchange="DoLocalLanguageChange(this)"
        size="1">
        <option value="de" >German</option>
        <option value="en" selected >English</option>
      </select>
    </td>
  </tr>
</table><!-- Language Selection End-->
```

HTML for "langswitch.html" in "de" folder

The header for the German langswitch.html page is the same as English, except the language is set to German.

```
<!DOCTYPE HTML PUBLIC "-//W3C//DTD HTML 4.01 Transitional//EN">
<html>
<head>
<meta http-equiv="Content-Language" content="de"><meta http-
equiv="Content-Type" content="text/html; charset=utf-8">
<title>Sprachumschaltung Deutsche Seite</title>
<script type="text/javascript" src="script/lang.js" ></script>
</head>
```

The HTML in the German page is identical to that of the English page, except that the default value of the selected language is German ("de").

```
<!-- Language Selection -->
<table>
  <tr>
    <td align="right" valign="top" nowrap>
      <!-- change language immediately on change of the selection -
->
      <select name="Language"
        onchange="DoLocalLanguageChange(this) "
        <size="1">
          <option value="de" selected >Deutsch</option>
          <option value="en" >Englisch</option>
        </select>
      </td>
    </tr>
  </table><!-- Language Selection End-->
```

JavaScript "lang.js" in "script" folder

The function "DoLocalLanguageChange()" is in the lang.js file. This function calls the "SetLangCookie()" function and then reloads the window that is displaying the HTML page.

The function "SetLangCookie()" constructs an assignment that assigns the value from the select list to the "siemens_automation_language" cookie of the document. It also sets the path to the application so that the switched page, and not the requesting page, receives the value of the cookie.

Optionally, in the commented section, the page could set an expiration value for the cookie.

```

function DoLocalLanguageChange(oSelect) {
    SetLangCookie(oSelect.value);
    top.window.location.reload();
}
function SetLangCookie(value) {
    var strval = "siemens_automation_language=";
    // This is the cookie by which the Web server
    // detects the desired language
    // This name is required by the Web server.
    strval = strval + value;
    strval = strval + "; path=/ ";
    // Set path to the application, since otherwise
    // path would be set to the requesting page
    // and this page would not get the cookie.
    /* OPTIONAL
    use expiration if this cookie should live longer
    than the current browser session:
    var now = new Date();
    var endttime = new Date(now.getTime() + expiration);
    strval = strval + "; expires=" +
        endttime.toGMTString() + ";";
    */
    document.cookie = strval;
}

```

11.6.9.3 Configuring STEP 7 to use a multi-language page structure

The procedure for configuring multi-language user-defined Web pages is similar to the general process for configuring user-defined Web pages (Page 641). When you have folders set up for languages, however, you set your HTML directory setting to the folder that contains the individual language folders. You do not set the HTML directory to be one of the language folders.

When you select the default HTML page, you navigate into the language folder and select the HTML page that is to be the start page. When you subsequently generate blocks and download the blocks to the CPU, the Web server displays the start page in the language folder that you configured.

For example, if the folder structure shown here was at C:\, the setting for HTML directory would be C:\html, and if English were to be the initial page display, you would navigate to en\langswitch.html for the default HTML page setting.



11.6.10 Advanced user-defined Web page control

When you generate data blocks for your user-defined Web pages, STEP 7 creates a control DB that it uses to control display of and interaction with the user-defined pages. STEP 7 also creates a set of fragment DBs that represent the individual pages. Under normal circumstances, you do not need to know the structure of the control DB or how to manipulate it.

If you want to turn a web application on and off, for example, or manipulate individual manual fragments, you use the control DB tags and the WWW instruction to do so.

Structure of the control DB

The control DB is an extensive data structure, and is accessible when programming your STEP 7 user program. Only some of the control data block tags are described here.

Commandstate structure

"Commandstate" is a structure that contains global commands and global states for the Web server.

Global commands in the "Commandstate" structure

The global commands apply to the Web server in general. You can deactivate the Web server or restart it from the control DB parameters.

| Block tag | Data type | Description |
|------------|-----------|--|
| init | BOOL | Evaluate the control DB and initialize the Web application |
| deactivate | BOOL | Deactivate the Web application |

Global states in the Commandstate structure

The global states apply to the Web server in general and contain status information about the Web application.

| Block tag | Data type | Description |
|--------------|-----------|--|
| initializing | BOOL | Web application is reading control DB |
| error | BOOL | Web application could not be initialized |
| deactivating | BOOL | Web application is terminating |
| deactivated | BOOL | Web application is terminated |

| Block tag | Data type | Description |
|-------------|-----------|---|
| initialized | BOOL | Web application is initialized |
| last_error | INT | Last error returned from a WWW instruction call (Page 642) when the return code of WWW is 16#0010: 16#0001: fragment DB structure is inconsistent 16#0002: the application name already exists 16#0003: no resources (memory) 16#0004: control DB structure is inconsistent 16#0005: fragment DB not available 16#0006: fragment DB not for AWP 16#0007: enumeration data is inconsistent 16#000D: conflicting size of the control DB |

Request table

The request table is an array of structures containing commands and states that apply to individual fragment DBs. If you created fragments with the AWP_Start_Fragment (Page 637) command of type "manual", the STEP 7 user program must control these pages through the control DB. The request states are read-only and provide information about the current fragment. You use the request commands to control the current fragment.

| Block tag | Data type | Description |
|------------|----------------------------|--|
| requesttab | ARRAY [1 .. 4] OF STRUCT | Array of structures for individual fragment DB control. The Web server can process up to four fragments at a time. The array index for a particular fragment is arbitrary when the Web server is processing multiple fragments or fragments from multiple browser sessions. |

Struct members of requesttab struct

| Block tag | Data type | Description |
|---------------------|-----------|--|
| page_index | UINT | Number of the current web page |
| fragment_index | UINT | Number of the current fragment - can be set to a different fragment |
| // Request Commands | | |
| continue | BOOL | Enables current page/fragment for sending and continues with the next fragment |
| repeat | BOOL | Enables current page/fragment for resending and continues with the same fragment |
| abort | BOOL | Close http connection without sending |
| finish | BOOL | Send this fragment; page is complete - do not process any additional fragments |
| // Request states | | The request states are read-only |
| idle | BOOL | Nothing to do, but active |
| waiting | BOOL | Fragment is waiting to be enabled |

| Block tag | Data type | Description |
|-----------|-----------|----------------------------------|
| sending | BOOL | Fragment is sending |
| aborting | BOOL | User has aborted current request |

Operation

Whenever your program makes changes to the control DB, it must call the WWW instruction with the number of the modified control DB as its parameter. The global commands and request commands take effect when the STEP 7 user program executes the WWW instruction (Page 642).

The STEP 7 user program can set the `fragment_index` explicitly, thus causing the Web server to process the specified fragment with a request command. Otherwise, the Web server processes the current fragment for the current page when the WWW instruction executes.

Possible techniques for using the `fragment_index` include:

- Processing the current fragment: Leave `fragment_index` unchanged and set the continue command.
- Skip the current fragment: Set `fragment_index` to 0 and set the continue command.
- Replace current fragment with a different fragment: Set the `fragment_index` to the new fragment ID and set the continue command.

To check global states or request states that might be changing, the STEP 7 user program must call the WWW instruction to evaluate the current values of these states. A typical usage might be to call the WWW instruction periodically until a specific state occurs.

Note

If the STEP 7 user program sets more than one request command, the WWW instruction processes only one in this order of precedence: abort, finish, repeat, continue. The WWW instruction clears all of the request commands after processing.

Examples

The following example shows a STEP 7 user program that is checking for a fragment with an ID of 1 to be in the waiting state, following a prior call to the WWW instruction. It might also wait for other application-specific conditions to occur. Then it performs whatever processing is necessary for the fragment, such as setting data block tags, performing calculations, or other application-specific tasks. Afterwards, it sets the continue flag so that the Web server will execute this fragment.

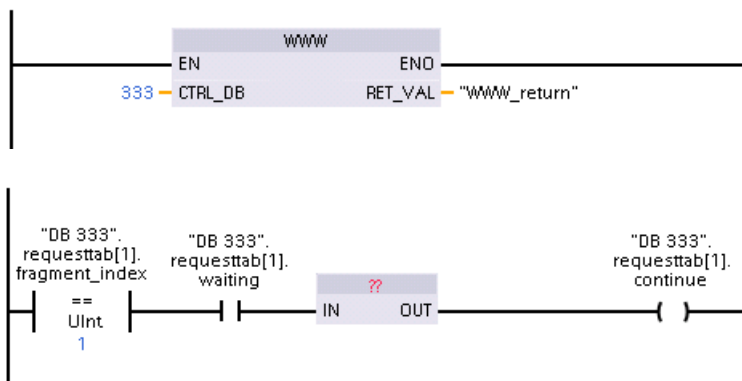

When the program calls the WWW instruction with this modified control DB, the user-defined Web page with this fragment can be displayed from the Web browser.

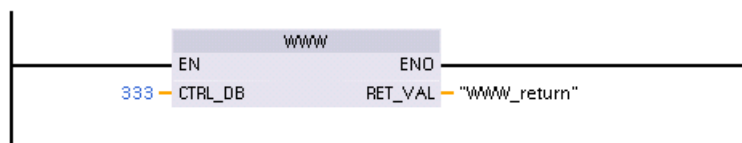

Note that this is a simplified example; the fragment to check could be in any one of the four requesttab structs in the array.

11.7 Constraints

The following IT considerations can affect your use of the Web server:

- Typically, you must use the IP address of the CPU to access the standard Web pages or user-defined Web pages, or the IP address of a wireless router with a port number. If your Web browser does not allow connecting directly to an IP address, see your IT administrator. If your local policies support DNS, you can connect to the IP address through a DNS entry to that address.
- Firewalls, proxy settings, and other site-specific restrictions can also restrict access to the CPU. See your IT administrator to resolve these issues.
- The standard Web pages use JavaScript and cookies. If your Web browser settings disable JavaScript or cookies, enable them. If you cannot enable them, some features are restricted (Page 665). Use of JavaScript and cookies in user-defined Web pages is optional. If used, you must enable them in your browser.
- The Web server supports Secure Sockets Layer (SSL). You can access the standard Web pages and user-defined Web pages with an URL of either `http://ww.xx.yy.zz` or `https://ww.xx.yy.zz`, where "ww.xx.yy.zz" represents the IP address of the CPU.
- Siemens provides a security certificate for secure access to the Web server. From the Introduction standard Web page (Page 613), you can download and import the certificate into the Internet options of your Web browser (Page 666). If you choose to not import the certificate, you will get a security verification prompt every time you access the Web server with `https://`.

Number of connections

The Web server supports a maximum of 30 active HTTP connections. Various actions consume the 30 connections, depending on the Web browser that you use and the number of different objects per page (.css files, images, additional .html files). Some connections persist while the Web server is displaying a page; other connections do not persist after the initial connection.

If, for example, you are using Mozilla Firefox 8, which supports a maximum of six persistent connections, you could use five browser or browser tab instances before the Web server starts dropping connections. In the case where a page is not using all six connections, you could have additional browser or browser tab instances.

Also be aware that the number of active connections can affect page performance.

Note

Log off prior to closing Web server

If you have logged in to the Web server, be sure to log off prior to closing your Web browser. The Web server supports a maximum of seven concurrent logins.

11.7.1 Feature restrictions when the Internet options disable JavaScript

The standard Web pages use HTML, JavaScript, and cookies. If your site restricts the use of JavaScript and cookies, then enable them for the pages to function properly. If you cannot enable JavaScript for your Web browser, the features that use JavaScript controls cannot run.

General

The pages do not update dynamically. You must manually refresh the page with the Refresh icon (Page 609) to view fresh data.

Diagnostic Buffer page

The Diagnostic Buffer page uses JavaScript as follows:

- Displaying the event details: With JavaScript, you select a row in the diagnostic buffer to see the details in the bottom section. Without JavaScript, you must click the event field hyperlink of a diagnostic buffer entry to see the event data in the bottom section.
- Changing the range of diagnostic buffer entries to view: With JavaScript, you use the drop-down list at the top to select the range of diagnostic buffer entries to view, and the page automatically updates. Without JavaScript, you use the drop-down list at the top to select the range of diagnostic buffer entries to view, but you must then click the "Go" link to update the diagnostic buffer page with the range you selected from the drop-down list.

Note that the "Go" and the event field hyperlinks are only visible when JavaScript is not enabled. They are not necessary and therefore are not present when JavaScript is enabled.

Module Information page

Without JavaScript enabled, the following restrictions apply:

- You cannot filter the data.
- You cannot sort fields.

Variable Status page

Without JavaScript enabled, the following restrictions apply:

- After you enter each variable, you must manually set the focus to the "New variable" row to enter a new variable.
- Selecting a display format does not automatically change the data value display to the selected format. You must click the "Monitor value" button to refresh the display with the new format.

11.7.2 Feature restrictions when the Internet options do not allow cookies

If you disable cookies in your Web browser, the following restrictions apply:

- You cannot log in.
- You cannot change the language setting.
- You cannot switch from UTC time to PLC time. Without cookies, all times are in UTC time.

11.7.3 Importing the Siemens security certificate

You can import the Siemens security certificate into your Internet options so that you won't be prompted for security verification when you enter `https://ww.xx.yy.zz` in your Web browser, where "ww.xx.yy.zz" is the IP address of the CPU. If you use an `http://` URL and not an `https://` URL, then you do not need to download and install the certificate.

Downloading the certificate

You use the "download certificate" link from the Introduction page (Page 613) to download the Siemens security certificate to your PC. The procedure varies according to which Web browser you use:

Importing the certificate to Internet Explorer

1. Click the "download certificate" link from the Introduction page. A "File Download - Security Warning" dialog pops up.
2. From the "File Download - Security Warning" dialog, click "Open" to open the file. A "Certificate" dialog appears.
3. From the "Certificate" dialog, click the "Install Certificate" button to launch the Certificate Import Wizard.
4. Follow the dialogs of the "Certificate Import Wizard" to import the certificate, letting the operating system automatically select the certificate store.

Importing the certificate to Mozilla Firefox

1. Click the "download certificate" link from the Intro page. An "Opening MiniWebCA_Cer.crt" dialog pops up.
2. Click "Save file" from the "Opening MiniWebCA_Cer.crt" dialog. A "Downloads" dialog appears.
3. From the "Downloads" dialog, double-click "MiniWebCA_Cer.crt". If you have attempted the download more than once, multiple copies show up. Just double-click any one of the "MiniWebCA_Cer.crt" entries.
4. Click "OK" if prompted to open an executable file.
5. Click "Open" on the "Open File - Security Warning" dialog if it appears. A "Certificate" dialog appears.

6. On the "Certificate" dialog, click the "Install Certificate" button.
7. Follow the dialogs of the "Certificate Import Wizard" to import the certificate, letting the operating system automatically select the certificate store.
8. If the "Security Warning" dialog appears, click "Yes" to confirm installation of the certificate.

Other browsers

Follow the conventions of your Web browser to import and install the Siemens certificate.

After you have installed the Siemens security certificate "S7-Controller Family" in the Internet options for your Web browser content, you will not be required to verify a security prompt when you access the Web server with `https:// ww.xx.yy.zz`.

Note

The security certificate remains constant through reboots of the CPU; however, if you change the IP address of the CPU you must follow the procedures above to download a new certificate.

11.7.4 Importing CSV format data logs to non-USA/UK versions of Microsoft Excel

Data log files are in the comma-separated values (CSV) file format. You can open these files directly in Excel from the Data Logs page when your system is running the USA or UK version of Excel. In other countries, however, this format is not widely used because commas occur frequently in numerical notation.

To open a data log file that you have saved, follow these steps for non USA/UK versions of Excel:

1. Open Excel and create an empty workbook.
2. From the "Data > Import External Data" menu, select the "Import Data" command.
3. Navigate to and select the data log file you want to open. The Text Import Wizard starts.
4. From the Text Import Wizard, change the default option for "Original data type" from "Fixed width" to "Delimited".
5. Click the Next button.
6. From the Step 2 dialog, select the "Comma" check box to change the delimiter type from "Tab" to "Comma".
7. Click the Next button.
8. From the Step 3 dialog, you can optionally change the Date format from MDY (month/day/year) to another format.
9. Complete the remaining steps of the Text Import Wizard to import the file.

Communication processor and Modbus TCP

12.1 Using the serial communication interfaces

Two communication modules (CMs) and one communication board (CB) provide the interface for PtP communications:

- CM 1241 RS232 (Page 975)
- CM 1241 RS422/485 (Page 976)
- CB 1241 RS485 (Page 973)

You can connect up to three CMs (of any type) plus a CB for a total of four communication interfaces. Install the CM to the left of the CPU or another CM. Install the CB on the front of the CPU. Refer to the "Installation" chapter in the S7-1200 System Manual (Page 62) for detailed instructions on module installation and removal.

The serial communication interfaces have the following characteristics:

- Have an isolated port
- Support Point-to-Point protocols
- Are configured and programmed through the point-to-point communication processor instructions
- Display transmit and receive activity by means of LEDs
- Display a diagnostic LED (CMs only)
- Are powered by the CPU: No external power connection is needed.

Refer to the technical specifications for communication interfaces (Page 964).

LED indicators

The communication modules have three LED indicators:

- Diagnostic LED (DIAG): This LED flashes red until it is addressed by the CPU. After the CPU powers up, it checks for CMs and addresses them. The diagnostic LED begins to flash green. This means that the CPU has addressed the CM, but has not yet provided the configuration to it. The CPU downloads the configuration to the configured CMs when the program is downloaded to the CPU. After a download to the CPU, the diagnostic LED on the communication module should be a steady green.
- Transmit LED (Tx): The transmit LED illuminates when data is being transmitted out the communication port.
- Receive LED (Rx): This LED illuminates when data is being received by the communication port.

The communication board provides transmit (TxD) and receive (RxD) LEDs. It has no diagnostic LED.

12.2 Biasing and terminating an RS485 network connector

Siemens provides an RS485 network connector (Page 991) that you can use to easily connect multiple devices to an RS485 network. The connector has two sets of terminals that allow you to attach the incoming and outgoing network cables. The connector also includes switches for selectively biasing and terminating the network.

Note

You terminate and bias only the two ends of the RS485 network. The devices in between the two end devices are not terminated or biased. Bare cable shielding: Approximately 12 mm (1/2 in) must contact the metal guides of all locations.

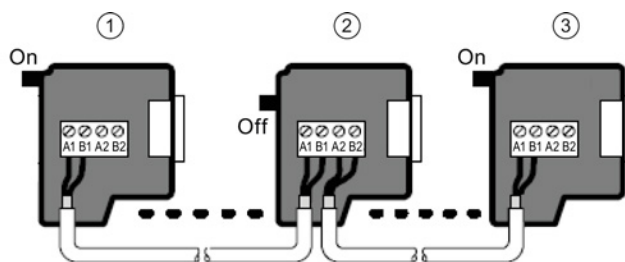

- ① Switch position = On: Terminated and biased
- ② Switch position = Off: No termination or bias
- ③ Switch position = On: Terminated and biased

Table 12- 1 Termination and bias for the RS485 connector

| Terminating device (bias ON) | Non-terminating device (bias OFF) |
|------------------------------|-----------------------------------|
| | |

- ① Pin number
- ② Network connector
- ③ Cable shield

The CB 1241 provides internal resistors for terminating and biasing the network. To terminate and bias the connection, connect TRA to TA and connect TRB to TB to include the internal resistors to the circuit. CB 1241 does not have a 9-pin connector. The following table shows the connections to a 9-pin connector on the communications partner.

Table 12-2 Termination and bias for the CB 1241

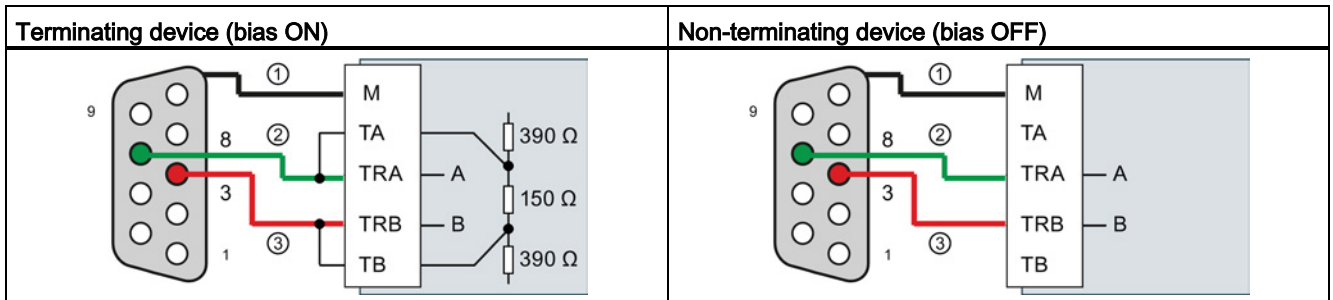

- ① Connect M to the cable shield
- ② A = TxD/RxD - (Green wire / Pin 8)
- ③ B = TxD/RxD + (Red wire / Pin 3)

12.3 Point-to-point (PtP) communication

The CPU supports the following Point-to-Point communication (PtP) for character-based serial protocols:

- PtP
- USS (Page 712)
- Modbus (Page 727)

PtP provides maximum freedom and flexibility, but requires extensive implementation in the user program.

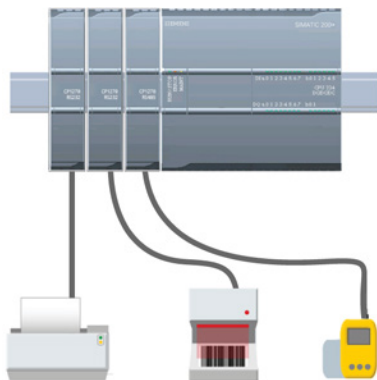

PtP enables a wide variety of possibilities:

- The ability to send information directly to an external device such as a printer
- The ability to receive information from other devices such as barcode readers, RFID readers, third-party camera or vision systems, and many other types of devices
- The ability to exchange information, sending and receiving data, with other devices such as GPS devices, third-party camera or vision systems, radio modems, and many more

This type of PtP communication is serial communication that uses standard UARTs to support a variety of baud rates and parity options. The RS232 and RS422/485 communication modules (CM 1241) and the RS485 communication board (CB 1241) provide the electrical interfaces for performing the PtP communications.

12.3.1 Configuring the communication ports

You can use either of the following methods to configure the communication interfaces:

- Use the device configuration in STEP 7 to configure the port parameters (baud and parity), the send parameters and the receive parameters. The CPU stores the device configuration settings and applies the settings after a power cycle and a RUN to STOP transition.
- Use the PORT_CFG (Page 686), SEND_CFG (Page 688), and RCV_CFG (Page 689) instructions to set the parameters. The port settings set by the instructions are valid while the CPU is in RUN mode. The port settings revert to the device configuration settings after a STOP transition or power cycle.

After configuring the hardware devices (Page 137), you configure parameters for the communication interfaces by selecting one of the CMs in your rack or the CB, if configured.



The "Properties" tab of the inspector window displays the parameters of the selected CM or CB. Select "Port configuration" to edit the following parameters:

- Baud rate
- Parity
- Data bits per character
- Number of stop bits
- Flow control (RS232 only)
- Wait time

For the CM 1241 RS232 and CB RS485 (except for flow control (Page 674), which only the CM 1241 RS232 supports), the port configuration parameters are the same regardless of whether you are configuring an RS232 or an RS485 communication module or the RS485 communication board. The parameter values can differ.

For the CM 1241 RS422/485, you have additional options for port configuration as shown below. The 422 mode of the CM 1241 RS422/485 module also supports software flow control.

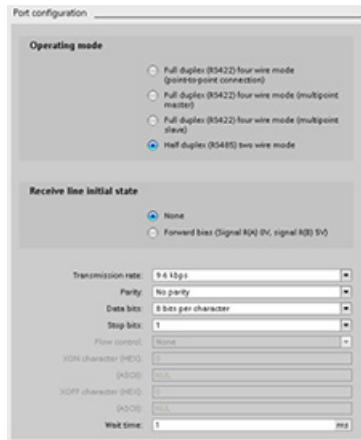

Select "Port configuration" to edit the following RS422/485 parameters:

- "Operating mode":
 - Full duplex (RS422) four wire mode (point-to-point connection)
 - Full duplex (RS422) four wire mode (multipoint master)
 - Full duplex (RS422) four wire mode (multipoint slave)
 - Half duplex (RS485) two wire mode
- "Receive line initial state":
 - None
 - Forward bias (Signal R(A) 0V, signal R(B) 5V)

The STEP 7 user program can also configure the port or change the existing configuration with the PORT_CFG instruction (Page 686).

Note

Parameter values set from the PORT_CFG instruction in the user program override port configuration settings set from the device configuration. Note that the S7-1200 does not retain parameters set from the PORT_CFG instruction in the event of power down.

| Parameter | Definition |
|----------------------------|---|
| Baud rate | The default value for the baud rate is 9.6 Kbits per second. Valid choices are: 300 baud, 600 baud, 1.2 Kbits, 2.4 Kbits, 4.8 Kbits, 9.6 Kbits, 19.2 Kbits, 38.4 Kbits, 57.6 Kbits, 76.8 Kbits, and 115.2 Kbits. |
| Parity | The default value for parity is no parity. Valid choices are: No parity, even, odd, mark (parity bit always set to 1), and space (parity bit always set to 0). |
| Data bits per character | The number of data bits in a character. Valid choices are 7 or 8. |
| Number of stop bits | The number of stop bits can be either one or two. The default is one. |
| Flow control | For the RS232 communication module, you can select either hardware or software flow control (Page 674). If you select hardware flow control, you can select whether the RTS signal is always on, or RTS is switched. If you select software flow control, you can define the XON and XOFF characters. The RS485 communication interfaces do not support flow control. The 422 mode of the CM 1241 RS422/485 module supports software flow control. |
| Wait time | Wait time specifies the time that the CM or CB waits to receive CTS after asserting RTS, or for receiving an XON after receiving an XOFF, depending on the type of flow control. If the wait time expires before the communication interface receives an expected CTS or XON, the CM or CB aborts the transmit operation and returns an error to the user program. You specify the wait time in milliseconds. The range is 0 to 65535 milliseconds. |
| Operating mode | This selects the operating mode RS422 or RS485 and network configurations. |
| Receive line initial state | This selects the bias options. Valid values are none, forward bias and reverse bias. Reverse bias is used to allow cable break detection. |

12.3.1.1 Managing flow control

Flow control refers to a mechanism for balancing the sending and receiving of data transmissions so that no data is lost. Flow control ensures that a transmitting device is not sending more information than a receiving device can handle. Flow control can be accomplished through either hardware or software. The RS232 CM supports both hardware and software flow control. The RS485 CM and CB do not support flow control. The 422 mode of the CM 1241 RS422/485 module supports software flow control. You specify the type of flow control either when you configure the port (Page 672) or with the PORT_CFG instruction (Page 686).

Hardware flow control works through the Request-to-send (RTS) and Clear-to-send (CTS) communication signals. With the RS232 CM, the RTS signal is output from pin 7 and the CTS signal is received through pin 8. The RS232 CM is a DTE (Data Terminal Equipment) device which asserts RTS as an output and monitors CTS as an input.

Hardware flow control: RTS switched

If you enable RTS switched hardware flow control for an RS232 CM, the module sets the RTS signal active to send data. It monitors the CTS signal to determine whether the receiving device can accept data. When the CTS signal is active, the module can transmit data as long as the CTS signal remains active. If the CTS signal goes inactive, then the transmission must stop.

Transmission resumes when the CTS signal becomes active. If the CTS signal does not become active within the configured wait time, the module aborts the transmission and returns an error to the user program. You specify the wait time in the port configuration (Page 672).

The RTS switched flow control is useful for devices that require a signal that the transmit is active. An example would be a radio modem that uses RTS as a "Key" signal to energize the radio transmitter. The RTS switched flow control will not function with standard telephone modems. Use the RTS always on selection for telephone modems.

Hardware flow control: RTS always on

In RTS always on mode, the CM 1241 sets RTS active by default. A device such as a telephone modem monitors the RTS signal from the CM and utilizes this signal as a clear-to-send. The modem only transmits to the CM when RTS is active, that is, when the telephone modem sees an active CTS. If RTS is inactive, the telephone module does not transmit to the CM.

To allow the modem to send data to the CM at any time, configure "RTS always on" hardware flow control. The CM thus sets the RTS signal active all the time. The CM will not set RTS inactive even if the module cannot accept characters. The transmitting device must ensure that it does not overrun the receive buffer of the CM.

Data Terminal Ready (DTR) and Data Set Ready (DSR) signal utilization

The CM sets DTR active for either type of hardware flow control. The module transmits only when the DSR signal becomes active. The state of DSR is only evaluated at the start of the send operation. If DSR becomes inactive after transmission has started, the transmission will not be paused.

Software flow control

Software flow control uses special characters in the messages to provide flow control. You configure Hex characters that represent XON and XOFF.

XOFF indicates that a transmission must stop. XON indicates that a transmission can resume. XOFF and XON must not be the same character.

When the transmitting device receives an XOFF character from the receiving device, it stops transmitting. Transmitting resumes when the transmitting device receives an XON character. If it does not receive an XON character within the wait time that is specified in the port configuration (Page 672), the CM aborts the transmission and returns an error to the user program.

Software flow control requires full-duplex communication, as the receiving partner must be able to send XOFF to the transmitting partner while a transmission is in progress. Software flow control is only possible with messages that contain only ASCII characters. Binary protocols cannot utilize software flow control.

12.3.2 Configuring the transmit (send) and receive parameters

Before the CPU can engage in PtP communications, you must configure parameters for transmitting (or sending) messages and receiving messages. These parameters dictate how communications operate when messages are being transmitted to or received from a target device.

12.3.2.1 Configuring transmit (send) parameters

From the device configuration of the CPU, you configure how a communication interface transmits data by setting the "Transmit message configuration" properties for the selected interface.

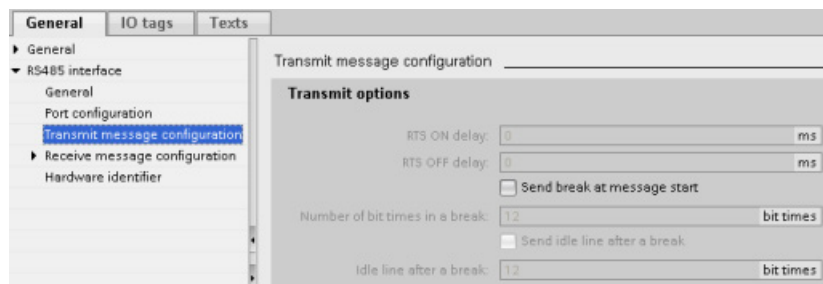

You can also dynamically configure or change the transmit message parameters from the user program by using the SEND_CFG (Page 688) instruction.

Note

Parameter values set from the SEND_CFG instruction in the user program override the "Transmit message configuration" properties. Note that the CPU does not retain parameters set from the SEND_CFG instruction in the event of power down.

| Parameter | Definition |
|---|---|
| RTS On delay | Specifies the amount of time to wait after activating RTS before transmission is initiated. The range is 0 to 65535 ms, with a default value of 0. This parameter is valid only when the port configuration (Page 672) specifies hardware flow control. CTS is evaluated after the RTS On delay time has expired. This parameter is applicable for RS232 modules only. |
| RTS Off delay | Specifies the amount of time to wait before de-activating RTS after completion of transmission. The range is 0 to 65535 ms, with a default value of 0. This parameter is valid only when the port configuration (Page 672) specifies hardware flow control. This parameter is applicable for RS232 modules only. |
| Send break at message start Number of bit times in a break | Specifies that upon the start of each message, a break will be sent after the RTS On delay (if configured) has expired and CTS is active. You specify how many bit times constitute a break where the line is held in a spacing condition. The default is 12 and the maximum is 65535, up to a limit of eight seconds. |
| Send idle line after a break Idle line after a break | Specifies that an idle line will be sent before message start. It is sent after the break, if a break is configured. The "Idle line after a break" parameter specifies how many bit times constitute an idle line where the line is held in a marking condition. The default is 12 and the maximum is 65535, up to a limit of eight seconds. |

12.3.2.2 Configuring receive parameters

From the device configuration of the CPU, you configure how a communication interface receives data, and how it recognizes both the start of and the end of a message. You set these parameters in the "Receive message configuration" properties for the selected interface.

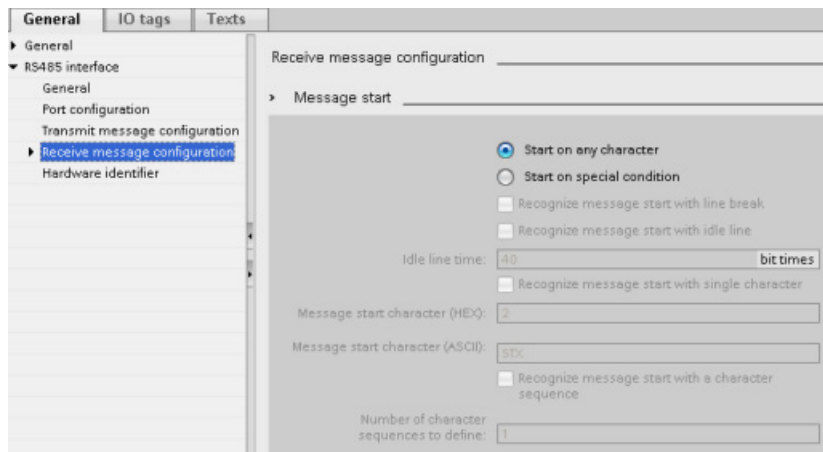

You can also dynamically configure or change the receive message parameters from the user program by using the RCV_CFG instruction (Page 689).

Note

Parameter values set from the RCV_CFG instruction in the user program override the "Receive message configuration" properties. Note that the CPU does not retain parameters set from the RCV_CFG instruction in the event of power down.

Message start conditions

You can determine how the communication interface recognizes the start of a message. The start characters and the characters comprising the message go into the receive buffer until a configured end condition is met.

You can specify multiple start conditions. If you specify more than one start condition, all of the start conditions must be met before the message is considered started. For example, if you configure an idle line time and a specific start character, the CM or CB will first look for the idle line time requirement to be met and then the CM will look for the specified start character. If some other character is received (not the specified start character), the CM or CB will restart the start of message search by again looking for an idle line time.

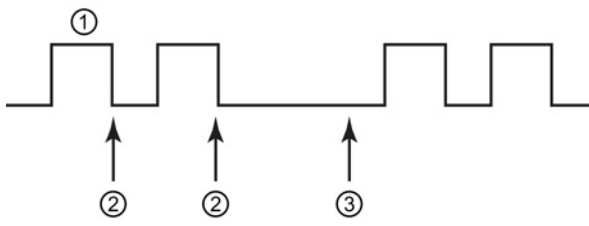
| Parameter | Definition |
|---|--|
| Start on Any Character | The Any Character condition specifies that any successfully received character indicates the start of a message. This character is the first character within a message. |
| Line Break | The Line Break condition specifies that a message receive operation starts after a break character is received. |
| Idle Line | <p>The Idle Line condition specifies that a message reception starts once the receive line has been idle or quiet for the number of specified bit times. Once this condition occurs, the start of a message begins.</p>  <p>① Characters ② Restarts the idle line timer ③ Idle line is detected and message receive is started</p> |
| Special condition: Recognize message start with single character | Specifies that a particular character indicates the start of a message. This character is then the first character within a message. Any character that is received before this specific character is discarded. The default character is STX. |
| Special condition: Recognize message start with a character sequence | <p>Specifies that a particular character sequence from up to four configured sequences indicates the start of a message. For each sequence, you can specify up to five characters. For each character position, you specify either a specific hex character, or that the character is ignored in sequence matching (wild-card character). The last specific character of a character sequence terminates that start condition sequence.</p> <p>Incoming sequences are evaluated against the configured start conditions until a start condition has been satisfied. Once the start sequence has been satisfied, evaluation of end conditions begins.</p> <p>You can configure up to four specific character sequences. You use a multiple-sequence start condition when different sequences of characters can indicate the start of a message. If any one of the character sequences is matched, the message is started.</p> |

12.3 Point-to-point (PtP) communication

The order of checking start conditions is:

- Idle line
- Line break
- Characters or character sequences

While checking for multiple start conditions, if one of the conditions is not met, the CM or CB will restart the checking with the first required condition. After the CM or CB establishes that the start conditions have been met, it begins evaluating end conditions.

Sample configuration - start message on one of two character sequences

Consider the following start message condition configuration:

The screenshot shows a configuration window for message start sequences. At the top, there is a checkbox labeled "Recognize message start with a character sequence" which is checked. Below it, a text field "Number of character sequences to define:" contains the value "2".

The main section is titled "5-character message start sequences" and contains a sub-section "Message start sequence 1". This sub-section has five character inspection options:

- Inspect character 1: Character value (HEX): 6A, Character value (ASCII): [empty]
- Inspect character 2: Character value (HEX): 0, Character value (ASCII): any
- Inspect character 3: Character value (HEX): 0, Character value (ASCII): any
- Inspect character 4: Character value (HEX): 0, Character value (ASCII): any
- Inspect character 5: Character value (HEX): 1C, Character value (ASCII): FS

Message start sequence 2

Inspect character 1
Character value (HEX): 0
Character value (ASCII): any

Inspect character 2
Character value (HEX): 6A
Character value (ASCII):

Inspect character 3
Character value (HEX): 6A
Character value (ASCII):

Inspect character 4
Character value (HEX): 0
Character value (ASCII): any

Inspect character 5
Character value (HEX): 0
Character value (ASCII): any

With this configuration, the start condition is satisfied when either pattern occurs:

- When a five-character sequence is received where the first character is 0x6A and the fifth character is 0x1C. The characters at positions 2, 3, and 4 can be any character with this configuration. After the fifth character is received, evaluation of end conditions begins.
- When two consecutive 0x6A characters are received, preceded by any character. In this case, evaluation of end conditions begins after the second 0x6A is received (3 characters). The character preceding the first 0x6A is included in the start condition.

Example sequences that would satisfy this start condition are:

- <any character> 6A 6A
- 6A 12 14 18 1C
- 6A 44 A5 D2 1C

Message end conditions

You also configure how the communication interface recognizes the end of a message. You can configure multiple message end conditions. If any one of the configured conditions occurs, the message ends.

For example, you could specify an end condition with an end of message timeout of 300 milliseconds, an inter-character timeout of 40 bit times, and a maximum length of 50 bytes. The message will end if the message takes longer than 300 milliseconds to receive, or if the gap between any two characters exceeds 40 bit times, or if 50 bytes are received.

12.3 Point-to-point (PtP) communication

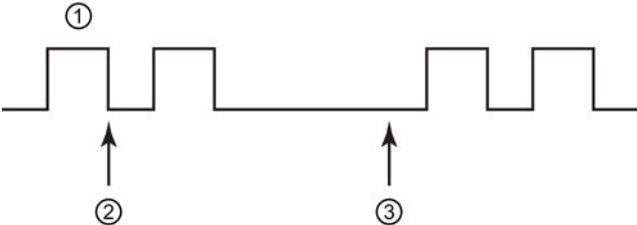
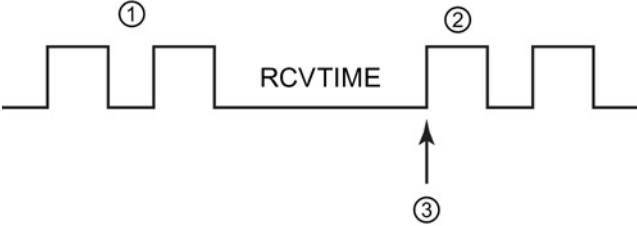
| Parameter | Definition |
|---|---|
| Recognize message end by message timeout | <p>The message end occurs when the configured amount of time to wait for the message end has expired. The message timeout period begins when a start condition has been satisfied. The default is 200 ms and the range is 0 to 65535 ms.</p>  <p>① Received characters ② Start Message condition satisfied: message timer starts ③ Message timer expires and terminates the message</p> |
| Recognize message end by response timeout | <p>The message end occurs when the configured amount of time to wait for a response expires before a valid start sequence is received. The response timeout period begins when a transmission ends and the CM or CB begins the receive operation. The default response timeout is 200 ms and the range is 0 to 65535 ms. If a character is not received within the response time period, RCVTIME, then an error is returned to the corresponding RCV_PTP instruction. The response timeout does not define a specific end condition. It only specifies that a character must be successfully received within the specified time. You must configure another end condition to indicate the actual end of a message.</p>  <p>① Transmitted characters ② Received characters ③ First character must be successfully received by this time.</p> |

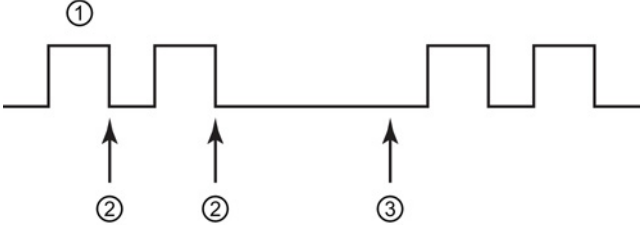
| Parameter | Definition |
|---|--|
| Recognize message end by inter-character gap | <p>The message end occurs when the maximum configured timeout between any two consecutive characters of a message has expired. The default value for the inter-character gap is 12 bit times and the maximum number is 65535 bit times, up to a maximum of eight seconds.</p>  <p>① Received characters ② Restarts the intercharacter timer ③ The intercharacter timer expires and terminates the message.</p> |
| Recognize message end by receiving a fixed number of characters | <p>The message end occurs when the specified number of characters has been received. The valid range for the fixed length is 1 to 4096. Note that for the S7-1200, this end condition is only valid for V4.0 CPUs or higher.</p> |
| Recognize message end by max length | <p>The message end occurs when the configured maximum number of characters has been received. The valid range for maximum length is 1 to 1023. This condition can be used to prevent a message buffer overrun error. When this end condition is combined with timeout end conditions and the timeout condition occurs, any valid received characters are provided even if the maximum length is not reached. This allows support for varying length protocols when only the maximum length is known.</p> |
| Read message length from message | <p>The message itself specifies the length of the message. The message end occurs when a message of the specified length has been received. The method for specifying and interpreting the message length is described below.</p> |
| Recognize message end with a character | <p>The message end occurs when a specified character is received.</p> |
| Recognize message end with a character sequence | <p>The message end occurs when a specified character sequence is received. You can specify a sequence of up to five characters. For each character position, you specify either a specific hex character, or that the character is ignored in sequence matching. Leading characters that are ignored characters are not part of the end condition. Trailing characters that are ignored characters are part of the end condition.</p> |

Sample configuration - end message with a character sequence

Consider the following end message condition configuration:

Recognize message end with a character sequence

5-character message end sequence

Check character 1

Character value (HEX): 0

Character value (ASCII): ANY

Check character 2

Character value (HEX): 6A

Character value (ASCII):

Check character 3

Character value (HEX): 6A

Character value (ASCII):

Check character 4

Character value (HEX): 0

Character value (ASCII): ANY

Check character 5

Character value (HEX): 0

Character value (ASCII): ANY

In this case, the end condition is satisfied when two consecutive 0x7A characters are received, followed by any two characters. The character preceding the 0x7A 0x7A pattern is not part of the end character sequence. Two characters following the 0x7A 0x7A pattern are required to terminate the end character sequence. The values received at character positions 4 and 5 are irrelevant, but they must be received to satisfy the end condition.

Specification of message length within the message

When you select the special condition where the message length is included in the message, you must provide three parameters that define information about the message length.

The actual message structure varies according to the protocol in use. The three parameters are as follows:

- n: the character position (1-based) within the message that starts the length specifier
- Length size: The number of bytes (one, two, or four) of the length specifier
- Length m: the number of characters following the length specifier that are not included in the length count

The ending characters do not need to be contiguous. The "Length m" value can be used to specify the length of a checksum field whose size is not included in the length field.

These fields appear in the Receive message configuration of the device properties:

Read message length from message

Offset of length field in message: 2 bytes

Size of length field: 1 bytes

The length field following the data is not included in the m...: 0 bytes

Recognize message end with a character sequence

Example 1: Consider a message structured according to the following protocol:

| STX | Len (n) | Characters 3 to 14 counted by the length | | | | | | | | | | | |
|-----|---------|--|------|---|-------|---|------|---|------|----|------|----|-----|
| | | ADR | PKE | | INDEX | | PWD | | STW | | HSW | | BCC |
| 1 | 2 | 3 | 4 | 5 | 6 | 7 | 8 | 9 | 10 | 11 | 12 | 13 | 14 |
| STX | 0x0C | xx | xxxx | | xxxx | | xxxx | | xxxx | | xxxx | | xx |

Configure the receive message length parameters for this message as follows:

- n = 2 (The message length starts with byte 2.)
- Length size = 1 (The message length is defined in one byte.)
- Length m = 0 (There are no additional characters following the length specifier that are not counted in the length count. Twelve characters follow the length specifier.)

In this example, the characters from 3 to 14 inclusive are the characters counted by Len (n).

Example 2: Consider another message structured according to the following protocol:

| SD1 | Len (n) | Len (n) | SD2 | Characters 5 to 10 counted by length | | | | | | FCS | ED |
|-----|---------|---------|-----|--------------------------------------|----|----|-------------------|----|----|-----|----|
| | | | | DA | SA | FA | Data unit=3 bytes | | | | |
| 1 | 2 | 3 | 4 | 5 | 6 | 7 | 8 | 9 | 10 | 11 | 12 |
| xx | 0x06 | 0x06 | xx | xx | xx | xx | xx | xx | xx | xx | xx |

Configure the receive message length parameters for this message as follows:

- n = 3 (The message length starts at byte 3.)
- Length size = 1 (The message length is defined in one byte.)
- Length m = 3 (There are three characters following the length specifier that are not counted in the length. In the protocol of this example, the characters SD2, FCS, and ED are not counted in the length count. The other six characters are counted in the length count; therefore the total number of characters following the length specifier is nine.)

In this example, the characters from 5 to 10 inclusive are the characters counted by Len (n).

12.3.3 Point-to-point instructions

12.3.3.1 Common parameters for Point-to-Point instructions

Table 12- 3 Common input parameters for the PTP instructions

| Parameter | Description |
|---------------------|--|
| REQ | <p>Many of the PtP instructions use the REQ input to initiate the operation on a low to high transition. The REQ input must be high (TRUE) for one execution of an instruction, but the REQ input can remain TRUE for as long as desired. The instruction does not initiate another operation until it has been called with the REQ input FALSE so that the instruction can reset the history state of the REQ input. This is required so that the instruction can detect the low to high transition to initiate the next operation.</p> <p>When you place a PtP instruction in your program, STEP 7 prompts you to identify the instance DB. Use a unique DB for each PtP instruction call. This ensures that each instruction properly handles inputs such as REQ.</p> |
| PORT | A port address is assigned during communication device configuration. After configuration, a default port symbolic name can be selected from the parameter assistant drop-list. The assigned CM or CB port value is the device configuration property "hardware identifier". The port symbolic name is assigned in the "Constants" tab of the PLC tag table. |
| Bit time resolution | Several parameters are specified in a number of bit times at the configured baud rate. Specifying the parameter in bit times allows the parameter to be independent of baud rate. All parameters that are in units of bit times can be specified to a maximum number of 65535. However, the maximum amount of time that a CM or CB can measure is eight seconds. |

The DONE, NDR, ERROR, and STATUS output parameters of the PtP instructions provide execution completion status for the PtP operations.

Table 12- 4 DONE, NDR, ERROR, and STATUS output parameters

| Parameter | Data type | Default | Description |
|-----------|-----------|---------|--|
| DONE | Bool | FALSE | Set TRUE for one execution to indicate that the last request completed without errors; otherwise, FALSE. |
| NDR | Bool | FALSE | Set TRUE for one execution to indicate that the requested action has completed without error and that the new data has been received; otherwise, FALSE. |
| ERROR | Bool | FALSE | Set TRUE for one execution to indicate that the last request completed with errors, with the applicable error code in STATUS; otherwise, FALSE. |
| STATUS | Word | 0 | <p>Result status:</p> <ul style="list-style-type: none"> • If the DONE or NDR bit is set, then STATUS is set to 0 or to an informational code. • If the ERROR bit is set, then STATUS is set to an error code. • If none of the above bits are set, then the instruction returns status results that describe the current state of the function. <p>STATUS retains its value for the duration of the execution of the function.</p> |

Note

The DONE, NDR, and ERROR parameters are set for one execution only. Your program logic must save temporary output state values in data latches, so you can detect state changes in subsequent program scans.

Table 12- 5 Common condition codes

| STATUS (W#16#....) | Description |
|--------------------|---|
| 0000 | No error |
| 7000 | Function is not busy |
| 7001 | Function is busy with the first call. |
| 7002 | Function is busy with subsequent calls (polls after the first call). |
| 8x3A | Illegal pointer in parameter x |
| 8070 | All internal instance memory in use, too many concurrent instructions in progress |
| 8080 | Port number is illegal. |
| 8081 | Timeout, module error, or other internal error |
| 8082 | Parameterization failed because parameterization is in progress in background. |
| 8083 | Buffer overflow: The CM or CB returned a received message with a length greater than the length parameter allowed. |
| 8090 | Internal error: Wrong message length, wrong submodule, or illegal message |
| 8091 | Internal error: Wrong version in parameterization message |
| 8092 | Internal error: Wrong record length in parameterization message |

Table 12- 6 Common error classes

| Class description | Error classes | Description |
|------------------------|---------------|--|
| Port configuration | 80Ax | Used to define common port configuration errors |
| Transmit configuration | 80Bx | Used to define common transmit configuration errors |
| Receive configuration | 80Cx | Used to define common receive configuration errors |
| Transmission runtime | 80Dx | Used to define common transmission runtime errors |
| Reception runtime | 80Ex | Used to define common reception runtime errors |
| Signal handling | 80Fx | Used to define common errors associated with all signal handling |

12.3.3.2 PORT_CFG (Configure communication parameters dynamically) instruction

Table 12- 7 PORT_CFG (Port Configuration) instruction

| LAD / FBD | SCL | Description |
|-----------|--|--|
| | <pre>"PORT_CFG_DB" (REQ:=_bool_in_, PORT:=_uint_in_, PROTOCOL:=_uint_in_, BAUD:=_uint_in_, PARITY:=_uint_in_, DATABITS:=_uint_in_, STOPBITS:=_uint_in_, FLOWCTRL:=_uint_in_, XONCHAR:=_char_in_, XOFFCHAR:=_char_in_, WAITTIME:=_uint_in_, DONE=>_bool_out_, ERROR=>_bool_out_, STATUS=>_word_out_);</pre> | <p>PORT_CFG allows you to change port parameters such as baud rate from your program.</p> <p>You can set up the initial static configuration of the port in the device configuration properties, or just use the default values. You can execute the PORT_CFG instruction in your program to change the configuration.</p> |

¹ STEP 7 automatically creates the DB when you insert the instruction.

The PORT_CFG configuration changes are not permanently stored in the CPU. The parameters configured in the device configuration are restored when the CPU transitions from RUN to STOP mode and after a power cycle. See Configuring the communication ports (Page 672) and Managing flow control (Page 674) for more information.

Table 12- 8 Data types for the parameters

| Parameter and type | Data type | Description |
|--------------------|-----------|---|
| REQ IN | Bool | Activate the configuration change on rising edge of this input. (Default value: False) |
| PORT IN | PORT | After you install and configure a CM or CB communication device, the port identifier appears in the parameter helper drop-list available at the PORT box connection. The assigned CM or CB port value is the device configuration property "hardware identifier". The port symbolic name is assigned in the "System constants" tab of the PLC tag table. (Default value: 0) |
| PROTOCOL IN | UInt | 0 - Point-to-Point communication protocol (Default value) 1..n - future definition for specific protocols |
| BAUD IN | UInt | Port baud rate (Default value: 0): 1 = 300 baud, 2 = 600 baud, 3 = 1200 baud, 4 = 2400 baud, 5 = 4800 baud, 6 = 9600 baud, 7 = 19200 baud, 8 = 38400 baud, 9 = 57600 baud, 10 = 76800 baud, 11 = 115200 baud |
| PARITY IN | UInt | Port parity (Default value: 0): 1 = No parity, 2 = Even parity, 3 = Odd parity, 4 = Mark parity, 5 = Space parity |
| DATABITS IN | UInt | Bits per character (Default value.): 1 = 8 data bits, 2 = 7 data bits |
| STOPBITS IN | UInt | Stop bits (Default value: 0): 1 = 1 stop bit, 2 = 2 stop bits |

| Parameter and type | | Data type | Description |
|--------------------|-----|-----------|--|
| FLOWCTRL | IN | UInt | Flow control (Default value: 0): 1 = No flow control, 2 = XON/XOFF, 3 = Hardware RTS always ON, 4 = Hardware RTS switched |
| XONCHAR | IN | Char | Specifies the character that is used as the XON character. This is typically a DC1 character (11H). This parameter is only evaluated if flow control is enabled. (Default value: 0) |
| XOFFCHAR | IN | Char | Specifies the character that is used as the XOFF character. This is typically a DC3 character (13H). This parameter is only evaluated if flow control is enabled. (Default value: 0) |
| XWAITIME | IN | UInt | Specifies how long to wait for a XON character after receiving a XOFF character, or how long to wait for the CTS signal after enabling RTS (0 to 65535 ms). This parameter is only evaluated if flow control is enabled. (Default value: 2000) |
| DONE | OUT | Bool | TRUE for one execution after the last request was completed with no error |
| ERROR | OUT | Bool | TRUE for one execution after the last request was completed with an error |
| STATUS | OUT | Word | Execution condition code (Default value: 0) |

Table 12- 9 Condition codes

| STATUS (W#16#....) | Description |
|--------------------|---|
| 80A0 | Specific protocol does not exist. |
| 80A1 | Specific baud rate does not exist. |
| 80A2 | Specific parity option does not exist. |
| 80A3 | Specific number of data bits does not exist. |
| 80A4 | Specific number of stop bits does not exist. |
| 80A5 | Specific type of flow control does not exist. |
| 80A6 | Wait time is 0 and flow control enabled |
| 80A7 | XON and XOFF are illegal values (for example, the same value) |

12.3.3.3 SEND_CFG (Configure serial transmission parameters dynamically) instruction

Table 12- 10 SEND_CFG (Send Configuration) instruction

| LAD / FBD | SCL | Description |
|-----------|--|---|
| | <pre>"SEND_CFG_DB" (REQ:=_bool_in_, PORT:=_uint_in_, RTSONDLY:=_uint_in_, RTSOFFDLY:=_uint_in_, BREAK:=_uint_in_, IDLELINE:=_uint_in_, DONE=>_bool_out_, ERROR=>_bool_out_, STATUS=>_word_out_);</pre> | <p>SEND_CFG allows the dynamic configuration of serial transmission parameters for a PtP communication port. Any queued messages within a CM or CB are discarded when SEND_CFG is executed.</p> |

¹ STEP 7 automatically creates the DB when you insert the instruction.

You can set up the initial static configuration of the port in the device configuration properties, or just use the default values. You can execute the SEND_CFG instruction in your program to change the configuration.

The SEND_CFG configuration changes are not permanently stored in the CPU. The parameters configured in the device configuration are restored when the CPU transitions from RUN to STOP mode and after a power cycle. See Configuring transmit (send) parameters (Page 675).

Table 12- 11 Data types for the parameters

| Parameter and type | Data type | Description |
|--------------------|-----------|---|
| REQ IN | Bool | Activate the configuration change on the rising edge of this input.. (Default value: False) |
| PORT IN | PORT | After you install and configure a CM or CB communication device, the port identifier appears in the parameter helper drop-list available at the PORT box connection. The assigned CM or CB port value is the device configuration property "hardware identifier". The port symbolic name is assigned in the "System constants" tab of the PLC tag table. (Default value: 0) |
| RTSONDLY IN | UInt | Number of milliseconds to wait after enabling RTS before any Tx data transmission occurs. This parameter is only valid when hardware flow control is enabled. The valid range is 0 - 65535 ms. A value of 0 disables the feature. (Default value: 0) |
| RTSOFFDLY IN | UInt | Number of milliseconds to wait after the Tx data transmission occurs before RTS is disabled: This parameter is only valid when hardware flow control is enabled. The valid range is 0 - 65535 ms. A value of 0 disables the feature. (Default value: 0) |
| BREAK IN | UInt | This parameter specifies that a break will be sent upon the start of each message for the specified number of bit times. The maximum is 65535 bit times up to an eight second maximum. A value of 0 disables the feature. (Default value: 12) |

| Parameter and type | | Data type | Description |
|--------------------|-----|-----------|--|
| IDLELINE | IN | UInt | This parameter specifies that the line will remain idle for the specified number of bit times before the start of each message. The maximum is 65535 bit times up to an eight second maximum. A value of 0 disables the feature. (Default value: 12) |
| DONE | OUT | Bool | TRUE for one execution after the last request was completed with no error |
| ERROR | OUT | Bool | TRUE for one execution after the last request was completed with an error |
| STATUS | OUT | Word | Execution condition code (Default value: 0) |

Table 12- 12 Condition codes

| STATUS (W#16#....) | Description |
|--------------------|---|
| 80B0 | Transmit interrupt configuration is not allowed. |
| 80B1 | Break time is greater than the maximum allowed value. |
| 80B2 | Idle time is greater than the maximum allowed value. |

12.3.3.4 RCV_CFG (Configure serial receive parameters dynamically) instruction

Table 12- 13 RCV_CFG (Receive Configuration) instruction

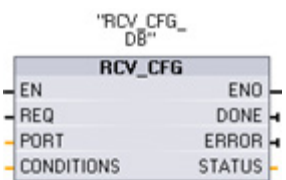
| LAD / FBD | SCL | Description |
|---|--|---|
|  | <pre>"RCV_CFG_DB" (REQ:=_bool_in_, PORT:=_uint_in_, CONDITIONS:=_struct_in_, DONE=>_bool_out_, ERROR=>_bool_out_, STATUS=>_word_out_);</pre> | <p>RCV_CFG performs dynamic configuration of serial receiver parameters for a PtP communication port. This instruction configures the conditions that signal the start and end of a received message. Any queued messages within a CM or CB are discarded when RCV_CFG is executed.</p> |

¹ STEP 7 automatically creates the DB when you insert the instruction.

You can set up the initial static configuration of the communication port in the device configuration properties, or just use the default values. You can execute the RCV_CFG instruction in your program to change the configuration.

The RCV_CFG configuration changes are not permanently stored in the CPU. The parameters configured in the device configuration are restored when the CPU transitions from RUN to STOP mode and after a power cycle. See Configuring receive parameters (Page 675) for more information.

12.3 Point-to-point (PtP) communication

Table 12- 14 Data types for the parameters

| Parameter and type | | Data type | Description |
|--------------------|-----|------------|---|
| REQ | IN | Bool | Activate the configuration change on the rising edge of this input. (Default value: False) |
| PORT | IN | PORT | After you install and configure a CM or CB communication device, the port identifier appears in the parameter helper drop-list available at the PORT box connection. The assigned CM or CB port value is the device configuration property "hardware identifier". The port symbolic name is assigned in the "System constants" tab of the PLC tag table. (Default value: 0) |
| CONDITIONS | IN | CONDITIONS | The Conditions data structure specifies the starting and ending message conditions as described below. |
| DONE | OUT | Bool | TRUE for one scan, after the last request was completed with no error |
| ERROR | OUT | Bool | TRUE for one scan, after the last request was completed with an error |
| STATUS | OUT | Word | Execution condition code (Default value: 0) |

Start conditions for the RCV_PTP instruction

The RCV_PTP instruction uses the configuration specified by the RCV_CFG instruction to determine the beginning and ending of point-to-point communication messages. The start of a message is determined by the start conditions. The start of a message can be determined by one or a combination of start conditions. If more than one start condition is specified, all the conditions must be satisfied before the message is started.

See the topic "Configuring receive parameters (Page 676)" for a description of the message start conditions.

Parameter CONDITIONS data type structure part 1 (start conditions)

Table 12- 15 CONDITIONS structure for START conditions

| Parameter and type | | Data type | Description |
|--------------------|----|-----------|--|
| STARTCOND | IN | UInt | Specifies the start condition (Default value: 1) <ul style="list-style-type: none"> • 01H - Start Char • 02H - Any Char • 04H - Line Break • 08H - Idle Line • 10H - Sequence 1 • 20H - Sequence 2 • 40H - Sequence 3 • 80H - Sequence 4 |
| IDLETIME | IN | UInt | The number of bit times required for idle line timeout. (Default value: 40). Only used with an idle line condition. 0 to 65535 |
| STARTCHAR | IN | Byte | The start character used with the start character condition. (Default value: B#16#2) |

| Parameter and type | | Data type | Description |
|--------------------|----|-----------|--|
| SEQ[1].CTL | IN | Byte | Sequence 1 ignore/compare control for each character: (Default value: B#16#0) These are the enabling bits for each character in start sequence <ul style="list-style-type: none"> • 01H - Character 1 • 02H - Character 2 • 04H - Character 3 • 08H - Character 4 • 10H - Character 5 Disabling the bit associated with a character means any character will match, in this sequence position. |
| SEQ[1].STR | IN | Char[5] | Sequence 1 start characters (5 characters). Default value: 0 |
| SEQ[2].CTL | IN | Byte | Sequence 2 ignore/compare control for each character. Default value: B#16#0 |
| SEQ[2].STR | IN | Char[5] | Sequence 2 start characters (5 characters). Default value: 0 |
| SEQ[3].CTL | IN | Byte | Sequence 3 ignore/compare control for each character. Default value: B#16#0 |
| SEQ[3].STR | IN | Char[5] | Sequence 3 start characters (5 characters). Default value: 0 |
| SEQ[4].CTL | IN | Byte | Sequence 4 ignore/compare control for each character. Default value: B#16#0 |
| SEQ[4].STR | IN | Char[5] | Sequence 4 start characters (5 characters), Default value: 0 |

Example

Consider the following received hexadecimal coded message: "68 10 aa 68 bb 10 aa 16" and the configured start sequences shown in the table below. Start sequences begin to be evaluated when the first 68H character is successfully received. Upon successfully receiving the fourth character (the second 68H), then start condition 1 is satisfied. Once the start conditions are satisfied, the evaluation of the end conditions begins.

The start sequence processing can be terminated due to various parity, framing, or inter-character timing errors. These errors result in no received message, because the start condition was not satisfied.

Table 12- 16 Start conditions

| Start condition | First Character | First Character +1 | First Character +2 | First Character +3 | First Character +4 |
|-----------------|-----------------|--------------------|--------------------|--------------------|--------------------|
| 1 | 68H | xx | xx | 68H | xx |
| 2 | 10H | aaH | xx | xx | xx |
| 3 | dcH | aaH | xx | xx | xx |
| 4 | e5H | xx | xx | xx | xx |

End conditions for the RCV_PTP instruction

The end of a message is determined by the specification of end conditions. The end of a message is determined by the first occurrence of one or more configured end conditions. The section "Message end conditions" in the topic "Configuring receive parameters (Page 676)" describes the end conditions that you can configure in the RCV_CFG instruction.

You can configure the end conditions in either the properties of the communication interface in the device configuration, or from the RCV_CFG instruction. Whenever the CPU transitions from STOP to RUN, the receive parameters (both start and end conditions) return to the device configuration settings. If the STEP 7 user program executes RCV_CFG, then the settings are changed to the RCV_CFG conditions.

Parameter CONDITIONS data type structure part 2 (end conditions)

Table 12- 17 CONDITIONS structure for END conditions

| Parameter | Parameter type | Data type | Description |
|------------|----------------|-------------|---|
| ENDCOND | IN | UInt 0 | This parameter specifies message end condition: <ul style="list-style-type: none"> • 01H - Response time • 02H - Message time • 04H - Inter-character gap • 08H - Maximum length • 10H - N + LEN + M • 20H - Sequence |
| MAXLEN | IN | UInt 1 | Maximum message length: Only used when the maximum length end condition is selected. 1 to 1024 bytes |
| N | IN | UInt 0 | Byte position within the message of the length field. Only used with the N + LEN + M end condition. 1 to 1022 bytes |
| LENGTHSIZE | IN | UInt 0 | Size of the length field (1, 2, or 4 bytes). Only used with the N + LEN + M end condition. |
| LENGTHM | IN | UInt 0 | Specify the number of characters following the length field that are not included in the value of the length field. This is only used with the N + LEN + M end condition. 0 to 255 bytes |
| RCVTIME | IN | UInt 200 | Specify how long to wait for the first character to be received. The receive operation will be terminated with an error if a character is not successfully received within the specified time. This is only used with the response time condition. (0 to 65535 bit times with an 8 second maximum) This parameter is not a message end condition since evaluation terminates when the first character of a response is received. It is an end condition only in the sense that it terminates a receiver operation because no response is received when a response is expected. You must select a separate end condition. |

| Parameter | Parameter type | Data type | Description |
|-----------|----------------|----------------|---|
| MSGTIME | IN | UInt 200 | Specify how long to wait for the entire message to be completely received once the first character has been received. This parameter is only used when the message timeout condition is selected. (0 to 65535 milliseconds) |
| CHARGAP | IN | UInt 12 | Specify the number of bit times between characters. If the number of bit times between characters exceeds the specified value, then the end condition will be satisfied. This is only used with the inter-character gap condition. (0 to 65535 bit times up to 8 second maximum) |
| SEQ.CTL | IN | Byte B#16#0 | Sequence 1 ignore/compare control for each character: These are the enabling bits for each character for the end sequence. Character 1 is bit 0, character 2 is bit 1, ..., character 5 is bit 4. Disabling the bit associated with a character means any character will match, in this sequence position. |
| SEQ.STR | IN | Char[5] 0 | Sequence 1 start characters (5 characters) |

Table 12- 18 Condition codes

| STATUS (W#16#....) | Description |
|--------------------|---|
| 80C0 | Illegal start condition selected |
| 80C1 | Illegal end condition selected, no end condition selected |
| 80C2 | Receive interrupt enabled and this is not possible. |
| 80C3 | Maximum length end condition is enabled and max length is 0 or > 1024. |
| 80C4 | Calculated length is enabled and N is >= 1023. |
| 80C5 | Calculated length is enabled and length is not 1, 2 or 4. |
| 80C6 | Calculated length is enabled and M value is > 255. |
| 80C7 | Calculated length is enabled and calculated length is > 1024. |
| 80C8 | Response timeout is enabled and response timeout is zero. |
| 80C9 | Inter-character gap timeout is enabled and it is zero. |
| 80CA | Idle line timeout is enabled and it is zero. |
| 80CB | End sequence is enabled but all chars are "don't care". |
| 80CC | Start sequence (any one of 4) is enabled but all characters are "don't care". |

12.3.3.5 SEND_PTP (Transmit send buffer data) instruction

Table 12- 19 SEND_PTP (Send Point-to-Point data) instruction

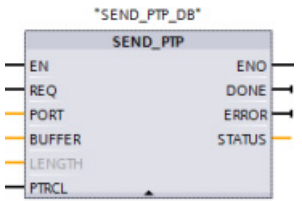
| LAD / FBD | SCL | Description |
|---|--|--|
|  | <pre>"SEND_PTP_DB" (REQ:=_bool_in_, PORT:=_uint_in_, BUFFER:=_variant_in_, LENGTH:=_uint_in_, PTRCL:=_bool_in_, DONE=>_bool_out_, ERROR=>_bool_out_, STATUS=>_word_out_);</pre> | <p>SEND_PTP initiates the transmission of the data and transfers the assigned buffer to the communication interface. The CPU program continues while the CM or CB sends the data at the assigned baud rate. Only one send operation can be pending at a given time. The CM or CB returns an error if a second SEND_PTP is executed while the CM or CB is already transmitting a message.</p> |

¹ STEP 7 automatically creates the DB when you insert the instruction.

Table 12- 20 Data types for the parameters

| Parameter and type | Data type | Description |
|---------------------------|-----------|---|
| REQ IN | Bool | Activates the requested transmission on the rising edge of this transmission enable input. This initiates transfer of the contents of the buffer to the Point-to-Point communication interface. (Default value: False) |
| PORT IN | PORT | After you install and configure a CM or CB communication device, the port identifier appears in the parameter helper drop-list available at the PORT box connection. The assigned CM or CB port value is the device configuration property "hardware identifier". The port symbolic name is assigned in the "System constants" tab of the PLC tag table. (Default value: 0) |
| BUFFER IN | Variant | This parameter points to the starting location of the transmit buffer. (Default value: 0) Note: Boolean data or Boolean arrays are not supported. |
| LENGTH ¹ IN | UInt | Transmitted frame length in bytes (Default value: 0) When transmitting a complex structure, always use a length of 0. |
| PTRCL IN | Bool | This parameter selects the buffer as normal point-to-point or specific Siemens-provided protocols that are implemented within the attached CM or CB. (Default value: False) FALSE = user program controlled point-to-point operations. (only valid option) |
| DONE OUT | Bool | TRUE for one scan, after the last request was completed with no error |
| ERROR OUT | Bool | TRUE for one scan, after the last request was completed with an error |
| STATUS OUT | Word | Execution condition code (Default value: 0) |

¹ Optional parameter: Click the arrow at the bottom of a LAD/FBD box to expand the box and include this parameter.

While a transmit operation is in progress, the DONE and ERROR outputs are FALSE. When a transmit operation is complete, either the DONE or the ERROR output will be set TRUE to show the status of the transmit operation. While DONE or ERROR is TRUE, the STATUS output is valid.

The instruction returns a status of 16#7001 if the communication interface accepts the transmit data. Subsequent SEND_PTP executions return 16#7002, if the CM or CB is still busy transmitting. When the transmit operation is complete, the CM or CB returns the status of the transmit operation as 16#0000 (if no errors occurred). Subsequent executions of SEND_PTP with REQ low return a status of 16#7000 (not busy).

The following diagrams show the relationship of the output values to REQ. This assumes that the instruction is called periodically to check for the status of the transmission process. In the diagram below, it is assumed that the instruction is called every scan (represented by the STATUS values).

| | | | | | | | |
|--------|-------|-------|-------|-------|-------|-------|-------|
| REQ | | | | | | | |
| DONE | | | | | | | |
| ERROR | | | | | | | |
| STATUS | 7000H | 7001H | 7002H | 7002H | 7002H | 0000H | 7000H |

The following diagram shows how the DONE and STATUS parameters are valid for only one scan if the REQ line is pulsed (for one scan) to initiate the transmit operation.

| | | | | | | | | |
|--------|-------|-------|-------|-------|-------|-------|-------|-------|
| REQ | | | | | | | | |
| DONE | | | | | | | | |
| ERROR | | | | | | | | |
| STATUS | 7000H | 7001H | 7002H | 7002H | 7002H | 0000H | 7000H | 7000H |

The following diagram shows the relationship of DONE, ERROR and STATUS parameters when there is an error.

| | | | | | | | | |
|--------|-------|-------|-------|-------|-------|-------|-------|-------|
| REQ | | | | | | | | |
| DONE | | | | | | | | |
| ERROR | | | | | | | | |
| STATUS | 7000H | 7001H | 7002H | 7002H | 7002H | 80D1H | 7000H | 7000H |

The DONE, ERROR and STATUS values are only valid until SEND_PTP executes again with the same instance DB.

Table 12- 21 Condition codes

| STATUS (W#16#....) | Description |
|--------------------|--|
| 80D0 | New request while transmitter active |
| 80D1 | Transmit aborted because of no CTS within wait time |
| 80D2 | Transmit aborted because of no DSR from the DCE device |
| 80D3 | Transmit aborted because of queue overflow (transmit more than 1024 bytes) |
| 80D5 | Reverse bias signal (wire break condition) |
| 833A | The DB for the BUFFER parameter does not exist. |

Interaction of the LENGTH and BUFFER parameters

The minimum size of data that can be transmitted by the SEND_PTP instruction is one byte. The BUFFER parameter determines the size of the data to be transmitted. You cannot use the data type Bool or arrays of Bool for the BUFFER parameter.

You can always set the LENGTH parameter to 0 and ensure that SEND_PTP sends the entire data structure represented by the BUFFER parameter. If you only want to send part of a data structure in the BUFFER parameter, you can set LENGTH as follows:

Table 12- 22 LENGTH and BUFFER parameters

| LENGTH | BUFFER | Description |
|--------|----------------------|---|
| = 0 | Not used | The complete data is sent as defined at the BUFFER parameter. You do not need to specify the number of transmitted bytes when LENGTH = 0. |
| > 0 | Elementary data type | The LENGTH value must contain the byte count of this data type. For example, for a Word value, the LENGTH must be two. For a Dword or Real, the LENGTH must be four. Otherwise, nothing is transferred and the error 8088H is returned. |
| | Structure | The LENGTH value can contain a byte count less than the complete byte length of the structure, in which case only the first LENGTH bytes of the structure are sent from the BUFFER. Since the internal byte organization of a structure cannot always be determined, you might get unexpected results. In this case, use a LENGTH of 0 to send the complete structure. |
| | Array | The LENGTH value must contain a byte count that is less than the complete byte length of the array and which must be a multiple of the data element byte count. For example, the LENGTH parameter for an array of Words must be a multiple of two and for an array of Reals, a multiple of four. When LENGTH is specified, the number of array elements which are contained in LENGTH bytes is transferred. If your BUFFER, for example, contains an array of 15 Dwords (60 total bytes), and you specify a LENGTH of 20, then the first five Dwords in the array are transferred. The LENGTH value must be a multiple of the data element byte count. Otherwise, STATUS = 8088H, ERROR = 1, and no transmission occurs. |
| | String | The LENGTH parameter contains the number of characters to be transmitted. Only the characters of the String are transmitted. The maximum and actual length bytes of the String are not transmitted. |

12.3.3.6 RCV_PTP (Enable receive messages) instruction

Table 12- 23 RCV_PTP (Receive Point-to-Point) instruction

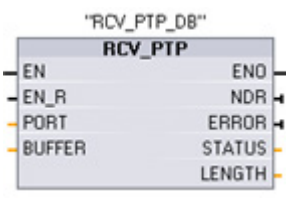
| LAD / FBD | SCL | Description |
|---|--|---|
|  | <pre>"RCV_PTP_DB" (EN_R:=_bool_in_, PORT:=_uint_in_, BUFFER:=_variant_in_, NDR=>_bool_out_, ERROR=>_bool_out_, STATUS=>_word_out_, LENGTH=>_uint_out_);</pre> | RCV_PTP checks for messages that have been received in the CM or CB. If a message is available, it will be transferred from the CM or CB to the CPU. An error returns the appropriate STATUS value. |

¹ STEP 7 automatically creates the DB when you insert the instruction.

Table 12- 24 Data types for the parameters

| Parameter and type | Data type | Description | |
|--------------------|-----------|-------------|---|
| EN_R | IN | Bool | When this input is TRUE and a message is available, the message is transferred from the CM or CB to the BUFFER. When EN_R is FALSE, the CM or CB is checked for messages and NDR, ERROR and STATUS output are updated, but the message is not transferred to the BUFFER. (Default value: 0) |
| PORT | IN | PORT | After you install and configure a CM or CB communication device, the port identifier appears in the parameter helper drop-list available at the PORT box connection. The assigned CM or CB port value is the device configuration property "hardware identifier". The port symbolic name is assigned in the "System constants" tab of the PLC tag table. (Default value: 0) |
| BUFFER | IN | Variant | This parameter points to the starting location of the receive buffer. This buffer should be large enough to receive the maximum length message. Boolean data or Boolean arrays are not supported. (Default value: 0) |
| NDR | OUT | Bool | TRUE for one execution when new data is ready and operation is complete with no errors. |
| ERROR | OUT | Bool | TRUE for one execution after the operation was completed with an error. |
| STATUS | OUT | Word | Execution condition code (Default value: 0) |
| LENGTH | OUT | UInt | Length of the returned message in bytes (Default value: 0) |

The STATUS value is valid when either NDR or ERROR is TRUE. The STATUS value provides the reason for termination of the receive operation in the CM or CB. This is typically a positive value, indicating that the receive operation was successful and that the receive process terminated normally. If the STATUS value is negative (the Most Significant Bit of the hexadecimal value is set), the receive operation was terminated for an error condition such as parity, framing, or overrun errors.

Each PtP communication interface can buffer up to a maximum of 1024 bytes. This could be one large message or several smaller messages. If more than one message is available in the CM or CB, the RCV_PTP instruction returns the oldest message available. A subsequent RCV_PTP instruction execution returns the next oldest message available.

12.3 Point-to-point (PtP) communication

Table 12- 25 Condition codes

| STATUS (W#16#...) | Description |
|-------------------|---|
| 0000 | No buffer present |
| 0094 | Message terminated due to received maximum character length |
| 0095 | Message terminated because of message timeout |
| 0096 | Message terminated because of inter-character timeout |
| 0097 | Message terminated because of response timeout |
| 0098 | Message terminated because the "N+LEN+M" length condition was satisfied |
| 0099 | Message terminated because of end sequence was satisfied |
| 80E0 | Message terminated because the receive buffer is full |
| 80E1 | Message terminated due to parity error |
| 80E2 | Message terminated due to framing error |
| 80E3 | Message terminated due to overrun error |
| 80E4 | Message terminated because calculated length exceeds buffer size |
| 80E5 | Reverse bias signal (wire break condition) |
| 833A | The DB for the BUFFER parameter does not exist. |

12.3.3.7 RCV_RST (Delete receive buffer) instruction

Table 12- 26 RCV_RST (Receiver Reset) instruction

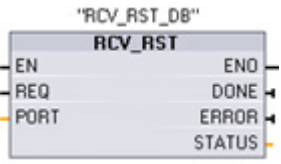
| LAD / FBD | SCL | Description |
|---|---|---|
|  | <pre>"RCV_RST_DB" (REQ:= _bool_in_, PORT:= _uint_in_, DONE=> _bool_out_, ERROR=> _bool_out_, STATUS=> _word_out_);</pre> | RCV_RST clears the receive buffers in the CM or CB. |

1 STEP 7 automatically creates the DB when you insert the instruction.

Table 12- 27 Data types for parameters

| Parameter and type | Data type | Description |
|--------------------|-----------|---|
| REQ IN | Bool | Activates the receiver reset on the rising edge of this enable input (Default value: False) |
| PORT IN | PORT | After you install and configure a CM or CB communication device, the port identifier appears in the parameter helper drop-list available at the PORT box connection. The assigned CM or CB port value is the device configuration property "hardware identifier". The port symbolic name is assigned in the "System constants" tab of the PLC tag table. (Default value: 0) |
| DONE OUT | Bool | When TRUE for one scan, indicates that the last request was completed without errors. |

| Parameter and type | | Data type | Description |
|--------------------|-----|-----------|---|
| ERROR | OUT | Bool | When TRUE, shows that the last request was completed with errors. Also, when this output is TRUE, the STATUS output will contain related error codes. |
| STATUS | OUT | Word | Error code (Default value: 0) See Common parameters for Point-to-Point instructions (Page 684) for communication status codes. |

Note

You might want to use the RCV_RST instruction to be sure the message buffers are clear following a communications error, or after changing a communication parameter such as the baud rate. Executing RCV_RST causes the module to clear all of the internal message buffers. After clearing the message buffers, you can be assured that when your program executes a subsequent receive instruction, the messages it returns are new messages and not old messages from some time prior to the RCV_RST call.

12.3.3.8 SGN_GET (Query RS-232 signals) instruction

Table 12- 28 SGN_GET (Get RS232 signals) instruction

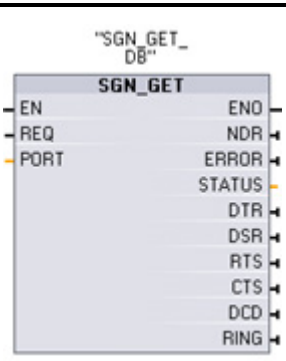
| LAD / FBD | SCL | Description |
|---|---|--|
|  | <pre>"SGN_GET_DB" (REQ:=_bool_in_, PORT:=_uint_in_, NDR=>_bool_out_, ERROR=>_bool_out_, STATUS=>_word_out_, DTR=>_bool_out_, DSR=>_bool_out_, RTS=>_bool_out_, CTS=>_bool_out_, DCD=>_bool_out_, RING=>_bool_out_);</pre> | <p>SGN_GET reads the current states of RS232 communication signals.</p> <p>This function is valid only for the RS232 CM.</p> |

¹ STEP 7 automatically creates the DB when you insert the instruction.

12.3 Point-to-point (PtP) communication

Table 12- 29 Data types for the parameters

| Parameter and type | | Data type | Description |
|--------------------|-----|-----------|--|
| REQ | IN | Bool | Get RS232 signal state values on the rising edge of this input (Default value: False) |
| PORT | IN | PORT | After you install and configure a CM or CB communication device, the port identifier appears in the parameter helper drop-list available at the PORT box connection. The assigned CM or CB port value is the device configuration property "hardware identifier". The port symbolic name is assigned in the "System constants" tab of the PLC tag table. |
| NDR | OUT | Bool | TRUE for one scan, when new data is ready and the operation is complete with no errors |
| ERROR | OUT | Bool | TRUE for one scan, after the operation was completed with an error |
| STATUS | OUT | Word | Execution condition code (Default value: 0) |
| DTR | OUT | Bool | Data terminal ready, module ready (output). Default value: False |
| DSR | OUT | Bool | Data set ready, communication partner ready (input). Default value: False |
| RTS | OUT | Bool | Request to send, module ready to send (output). Default value: False |
| CTS | OUT | Bool | Clear to send, communication partner can receive data (input). Default value: False |
| DCD | OUT | Bool | Data carrier detect, receive signal level (always False, not supported) |
| RING | OUT | Bool | Ring indicator, indication of incoming call (always False, not supported) |

Table 12- 30 Condition codes

| STATUS (W#16#...) | Description |
|-------------------|--|
| 80F0 | CM or CB is RS485 and no signals are available |

12.3.3.9 SGN_SET (Set RS-232 signals) instruction

Table 12- 31 SGN_SET (Set RS232 signals) instruction

| LAD / FBD | SCL | Description |
|-----------|--|---|
| | <pre>"SGN_SET_DB" (REQ:=_bool_in_, PORT:=_uint_in_, SIGNAL:=_byte_in_, RTS:=_bool_in_, DTR:=_bool_in_, DSR:=_bool_in_, DONE=>_bool_out_, ERROR=>_bool_out_, STATUS=>_word_out_);</pre> | <p>SGN_SET sets the states of RS232 communication signals.</p> <p>This function is valid only for the RS232 CM.</p> |

¹ STEP 7 automatically creates the DB when you insert the instruction.

Table 12- 32 Data types for parameters

| Parameter and type | | Data type | Description |
|--------------------|-----|-----------|---|
| REQ | IN | Bool | Start the set RS232 signals operation, on the rising edge of this input (Default value: False) |
| PORT | IN | PORT | After you install and configure a CM or CB communication device, the port identifier appears in the parameter helper drop-list available at the PORT box connection. The assigned CM or CB port value is the device configuration property "hardware identifier". The port symbolic name is assigned in the "System constants" tab of the PLC tag table. (Default value: 0) |
| SIGNAL | IN | Byte | Selects which signal to set: (multiple allowed). Default value: 0 <ul style="list-style-type: none"> • 01H = Set RTS • 02H = Set DTR • 04H = Set DSR |
| RTS | IN | Bool | Request to send, module ready to send value to set (true or false), Default value: False |
| DTR | IN | Bool | Data terminal ready, module ready to send value to set (true or false). Default value: False |
| DSR | IN | Bool | Data set ready (only applies to DCE type interfaces), not used. |
| DONE | OUT | Bool | TRUE for one execution after the last request was completed with no error |
| ERROR | OUT | Bool | TRUE for one execution after the last request was completed with an error |
| STATUS | OUT | Word | Execution condition code (Default value: 0) |

Table 12- 33 Condition codes

| STATUS (W#16#....) | Description |
|--------------------|--|
| 80F0 | CM or CB is RS485 and no signals can be set |
| 80F1 | Signals cannot be set because of Hardware flow control |
| 80F2 | Cannot set DSR because module is DTE |
| 80F3 | Cannot set DTR because module is DCE |

12.3.4 Programming the PtP communications

STEP 7 provides extended instructions that enable the user program to perform Point-to-Point communications with a protocol designed and implemented in the user program. These instructions fall into two categories:

- Configuration instructions
- Communication instructions

Configuration instructions

Before your user program can engage in PtP communication, you must configure the communication interface port and the parameters for sending data and receiving data.

You can perform the port configuration and message configuration for each CM or CB through the device configuration or through these instructions in your user program:

- PORT_CFG (Page 686)
- SEND_CFG (Page 688)
- RCV_CFG (Page 689)

Communication instructions

The PtP communication instructions enable the user program to send messages to and receive messages from the communication interfaces. For information about transferring data with these instructions, see the section on data consistency (Page 178).

All of the PtP functions operate asynchronously. The user program can use a polling architecture to determine the status of transmissions and receptions. SEND_PTP and RCV_PTP can execute concurrently. The communication modules and communication board buffer the transmit and receive messages as necessary up to a maximum buffer size of 1024 bytes.

The CMs and CB send messages to and receive messages from the actual point-to-point devices. The message protocol is in a buffer that is either received from or sent to a specific communication port. The buffer and port are parameters of the send and receive instructions:

- SEND_PTP (Page 694)
- RCV_PTP (Page 697)

Additional instructions provide the capability to reset the receive buffer, and to get and set specific RS232 signals:

- RCV_RST (Page 698)
- SGN_GET (Page 699)
- SGN_SET (Page 700)

12.3.4.1 Polling architecture

The STEP 7 user program must call the S7-1200 point-to-point instructions cyclically/periodically to check for received messages. Polling the send tells the user program when the transmit has completed.

Polling architecture: master

The typical sequence for a master is as follows:

1. A SEND_PTP instruction initiates a transmission to the CM or CB.
2. The SEND_PTP instruction is executed on subsequent scans to poll for the transmit complete status.
3. When the SEND_PTP instruction indicates that the transmission is complete, the user code can prepare to receive the response.
4. The RCV_PTP instruction is executed repeatedly to check for a response. When the CM or CB has collected a response message, the RCV_PTP instruction copies the response to the CPU and indicates that new data has been received.
5. The user program can process the response.
6. Go to step 1 and repeat the cycle.

Polling architecture: slave

The typical sequence for a slave is as follows:

1. The user program executes the RCV_PTP instruction every scan.
2. When the CM or CB has received a request, the RCV_PTP instruction indicates that new data is ready and the request is copied into the CPU.
3. The user program services the request and generates a response.
4. Use a SEND_PTP instruction to send the response back to the master.
5. Repeatedly execute SEND_PTP to be sure the transmit occurs.
6. Go to step 1 and repeat the cycle.

The slave must be responsible for calling RCV_PTP frequently enough to receive a transmission from the master before the master times out while waiting for a response. To accomplish this task, the user program can call RCV_PTP from a cyclic OB, where the cycle time is sufficient to receive a transmission from the master before the timeout period expires. If you set the cycle time for the OB to provide for two executions within the timeout period of the master, the user program can receive transmissions without missing any.

12.3.5 Example: Point-to-Point communication

In this example, an S7-1200 CPU communicates to a PC with a terminal emulator through a CM 1241 RS232 module. The point-to-point configuration and STEP 7 program in this example illustrate how the CPU can receive a message from the PC and echo the message back to the PC.

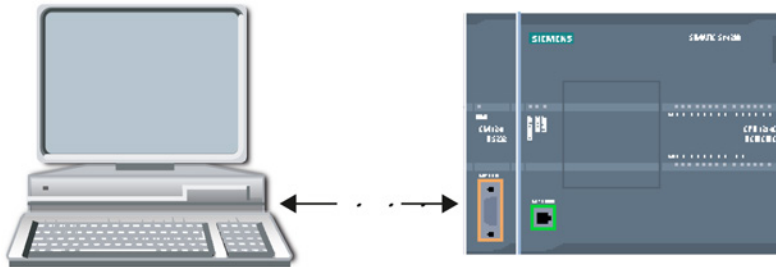

You must connect the communication interface of the CM 1241 RS232 module to the RS232 interface of the PC, which is normally COM1. Because both of these ports are Data Terminal Equipment (DTE), you must switch the receive and transmit pins (2 and 3) when connecting the two ports, which you can accomplish by either of the following methods:

- Use a NULL modem adapter to swap pins 2 and 3 together with a standard RS232 cable.
- Use a NULL modem cable, which already has pins 2 and 3 swapped. You can usually identify a NULL modem cable as one with two female 9-pin D connector ends.

12.3.5.1 Configuring the communication module

You can configure the CM 1241 from the Device configuration in STEP 7 or with user program instructions. This example uses the Device configuration method.

- Port configuration: Click the communication port of the CM module from the Device configuration, and configure the port as shown:

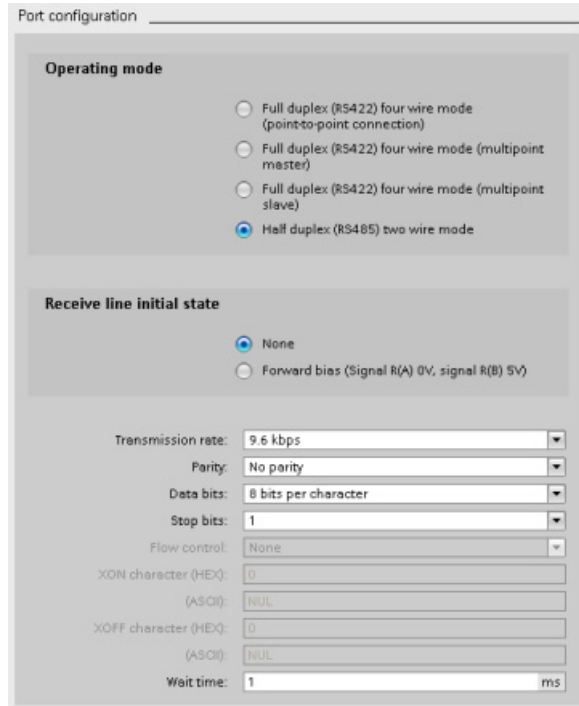

Note

The configuration settings for "Operating mode" and "Receive line initial state" are only applicable for the CM 1241 (RS422/RS485) module. The other CM 1241 modules do not have these port configuration settings. Refer to Configuring the RS422 and RS485 (Page 707).

- Transmit message configuration: Accept the default for transmit message configuration. No break is to be sent at message start.

12.3 Point-to-point (PtP) communication

- Receive message start configuration: Configure the CM 1241 to start receiving a message when the communication line is inactive for at least 50 bit times (about 5 milliseconds at 9600 baud = $50 * 1/9600$):

> Message start

Start on any character
 Start on special condition
 Recognize message start with broken line
 Recognize message start with idle line

Idle line time: 50 Bit times
 Recognize message start with single character

Message start character (HEX): 2
Message start character (ASCII): STX
 Recognize message start with a character sequence

Number of character sequences to define: 1

- Receive message end configuration: Configure the CM 1241 to end a message when it receives a maximum of 100 bytes or a linefeed character (10 decimal or a hexadecimal). The end sequence allows up to five end characters in sequence. The fifth character in the sequence is the linefeed character. The preceding four end sequence characters are "don't care" or unselected characters. The CM 1241 does not evaluate the "don't care" characters but looks for a linefeed character preceded by zero or more "don't care" characters to indicate the message end.

> Message end

Define message end conditions

Recognize message end by message timeout
Message timeout: 200 ms
 Recognize message end by response timeout
Response timeout: 200 ms
 Recognize message end by inter-character timeout
Inter-character gap timeout: 12 Bit times
 Recognize message end by maximum length
Maximum length of message: 100 bytes
 Read message length from message
Offset of length field in message: 1 bytes
Size of length field: 1 bytes
The length field following the data is not included in the m...
 Recognize message end with a character sequence

5-character message end sequence

| |
|---|
| <input type="checkbox"/> Check character 1 |
| Character value (HEX): 0 |
| Character value (ASCII): ANY |
| <input type="checkbox"/> Check character 2 |
| Character value (HEX): 0 |
| Character value (ASCII): ANY |
| <input type="checkbox"/> Check character 3 |
| Character value (HEX): 0 |
| Character value (ASCII): ANY |
| <input type="checkbox"/> Check character 4 |
| Character value (HEX): 0 |
| Character value (ASCII): ANY |
| <input checked="" type="checkbox"/> Check character 5 |
| Character value (HEX): A |
| Character value (ASCII): LF |

12.3.5.2 RS422 and RS485 operating modes

Configuring the RS422

For RS422 mode, there are three operating modes depending on your network configuration. Select one of these operating modes based on the devices in your network. The different selections for Receive line initial state reference the cases shown below for more details.

- Full duplex (RS422) four wire mode (point-to-point connection): select this option when there are two devices on your network. In the Receive line initial state:
 - Select none when you supply the bias and termination (Case 3).
 - Select forward bias to use internal bias and termination (Case 2).
 - Select reverse bias to use internal bias and termination, and enable cable break detection for both devices (Case 1).
- Full duplex (RS422) four wire mode (multipoint master): select this option for the master device when you have a network with one master and multiple slaves. In the Receive line initial state:
 - Select none when you supply the bias and termination (Case 3).
 - Select forward bias to use internal bias and termination (Case 2).
 - Cable break detection is not possible in this mode.
- Full duplex (RS422) four wire mode (multipoint slave): Select this option for all the slave devices when you have a network with one master and multiple slaves. In the Receive line initial state:
 - Select none when you supply the bias and termination (Case 3).
 - Select forward bias to use internal bias and termination (Case 2).
 - Select reverse bias to use internal bias and termination, and enable cable break detection for the slaves (Case 1).

Case 1: RS422 with cable break detection

- Mode of operation: RS422
- Receive line initial state: Reverse bias (biased with $R(A) > R(B) > 0V$)
- Cable break: Cable break detection enabled (transmitter always active)

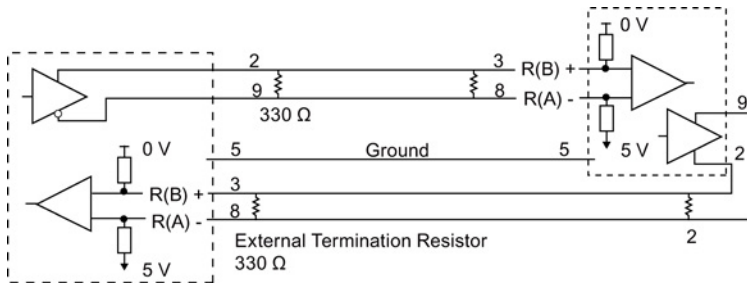

Case 2: RS422 No cable break detection, forward bias

- Mode of operation: RS422
- Receive line initial state: Forward bias (biased with $R(B) > R(A) > 0V$)
- Cable break: No cable break detection (transmitter enabled only while transmitting)

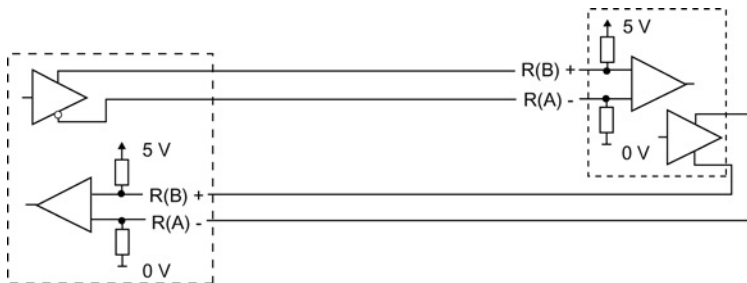

Case 3: RS422: No cable break detection, no bias

- Mode of operation: RS422
- Receive line initial state: no bias
- Cable break: No cable break detection (transmitter enabled only while transmitting)

Bias and termination are added by the user at the end nodes of the network.

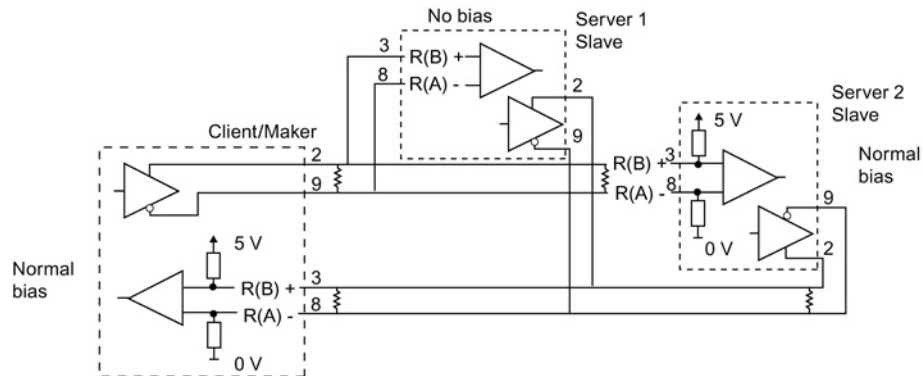

Configuring the RS485

For RS485 mode, there is only one operating mode. The different selections for Receive line initial state reference the cases shown below for more details.

- Half duplex (RS485) two wire mode. In the Receive line initial state:
 - Select none when you supply the bias and termination (Case 5).
 - Select forward bias to use internal bias and termination (Case 4).

Case 4: RS485: Forward bias

- Mode of operation: RS485
- Receive line initial state: Forward bias (biased with $R(B) > R(A) > 0 V$)



Case 5: RS485: No bias (external bias)

- Mode of operation: RS485
- Receive line initial state: No bias (external bias required)



12.3.5.3 Programming the STEP 7 program

The example program uses a global data block for the communication buffer, a RCV_PTP instruction (Page 697) to receive data from the terminal emulator, and a SEND_PTP instruction (Page 694) to echo the buffer back to the terminal emulator. To program the example, add the data block configuration and Main program block OB 1 as described below.

Global data block "Comm_Buffer": Create a global data block (DB) and name it "Comm_Buffer". Create one value in the data block called "buffer" with a data type of "array [0 .. 99] of byte".

Network 1: Enable the RCV_PTP instruction whenever SEND_PTP is not active. Tag_8 at MW20.0 indicates when sending is complete in Network 4, and when the communication module is thus ready to receive a message.

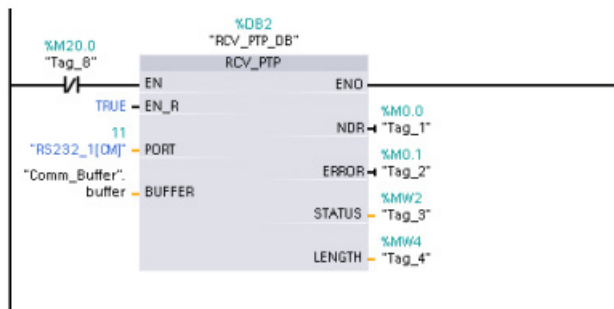

Network 2: Use the NDR value (Tag_1 at M0.0) set by the RCV_PTP instruction to make a copy of the number of bytes received and to set a flag (Tag_8 at M20.0) to trigger the SEND_PTP instruction.

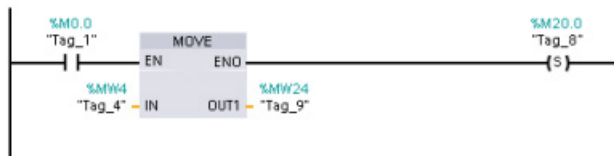

Network 3: Enable the SEND_PTP instruction when the M20.0 flag is set. Also use this flag to set the REQ input to TRUE for one scan. The REQ input tells the SEND_PTP instruction that a new request is to be transmitted. The REQ input must only be set to TRUE for one execution of SEND_PTP. The SEND_PTP instruction is executed every scan until the transmit completes. The transmit is complete when the last byte of the message has been transmitted from the CM 1241. When the transmit is complete, the DONE output (Tag_5 at M10.0) is set TRUE for one execution of SEND_PTP.

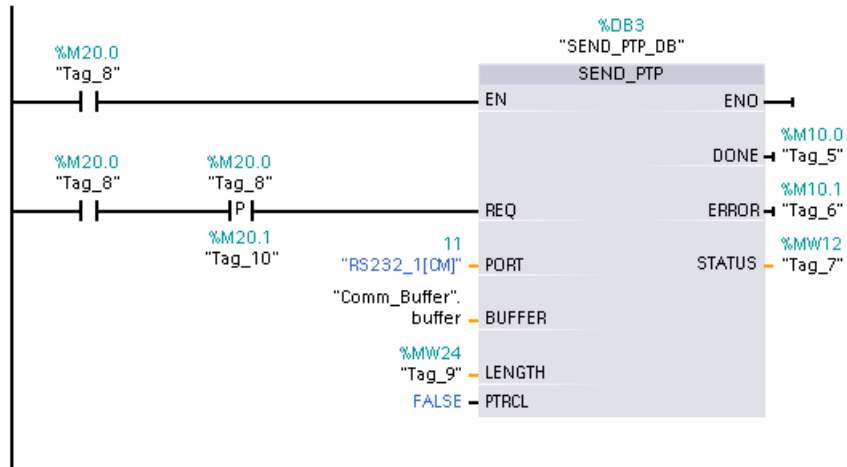

Network 4: monitor the DONE output of SEND_PTP and reset the transmit flag (Tag_8 at M20.0) when the transmit operation is complete. When the transmit flag is reset, the RCV_PTP instruction in Network 1 is enabled to receive the next message.

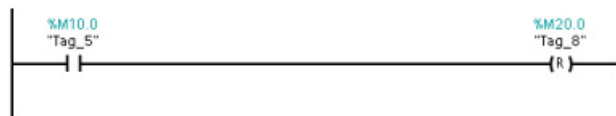

12.3.5.4 Configuring the terminal emulator

You must set up the terminal emulator to support the example program. You can use most any terminal emulator on your PC, such as HyperTerminal. Make sure that the terminal emulator is in the disconnected mode before editing the settings as follows:

1. Set the terminal emulator to use the RS232 port on the PC (normally COM1).
2. Configure the port for 9600 baud, 8 data bits, no parity (none), 1 stop bit and no flow control.
3. Change the settings of the terminal emulator to emulate an ANSI terminal.
4. Configure the terminal emulator ASCII setup to send a line feed after every line (after the user presses the Enter key).
5. Echo the characters locally so that the terminal emulator displays what is typed.

12.3.5.5 Running the example program

To exercise the example program, follow these steps:

1. Download the STEP 7 program to the CPU and ensure that it is in RUN mode.
2. Click the "connect" button on the terminal emulator to apply the configuration changes and open a terminal session to the CM 1241.
3. Type characters at the PC and press Enter.

The terminal emulator sends the characters to the CM 1241 and to the CPU. The CPU program then echoes the characters back to the terminal emulator.

12.4 Universal serial interface (USS) communication

The USS instructions control the operation of motor drives which support the universal serial interface (USS) protocol. You can use the USS instructions to communicate with multiple drives through RS485 connections to CM 1241 RS485 communication modules or a CB 1241 RS485 communication board. Up to three CM 1241 RS422/RS485 modules and one CB 1241 RS485 board can be installed in a S7-1200 CPU. Each RS485 port can operate up to sixteen drives.

The USS protocol uses a master-slave network for communications over a serial bus. The master uses an address parameter to send a message to a selected slave. A slave itself can never transmit without first receiving a request to do so. Direct message transfer between the individual slaves is not possible. USS communication operates in half-duplex mode. The following USS illustration shows a network diagram for an example drive application.

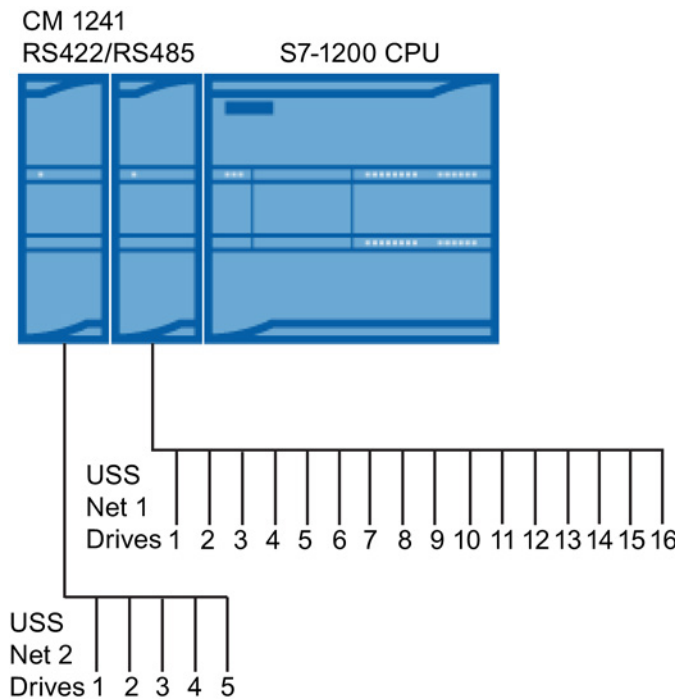

12.4.1 Requirements for using the USS protocol

The four USS instructions use 1 FB and 3 FCs to support the USS protocol. One USS_PORT instance data block (DB) is used for each USS network. The USS_PORT instance data block contains temporary storage and buffers for all drives on that USS network. The USS instructions share the information in this data block.

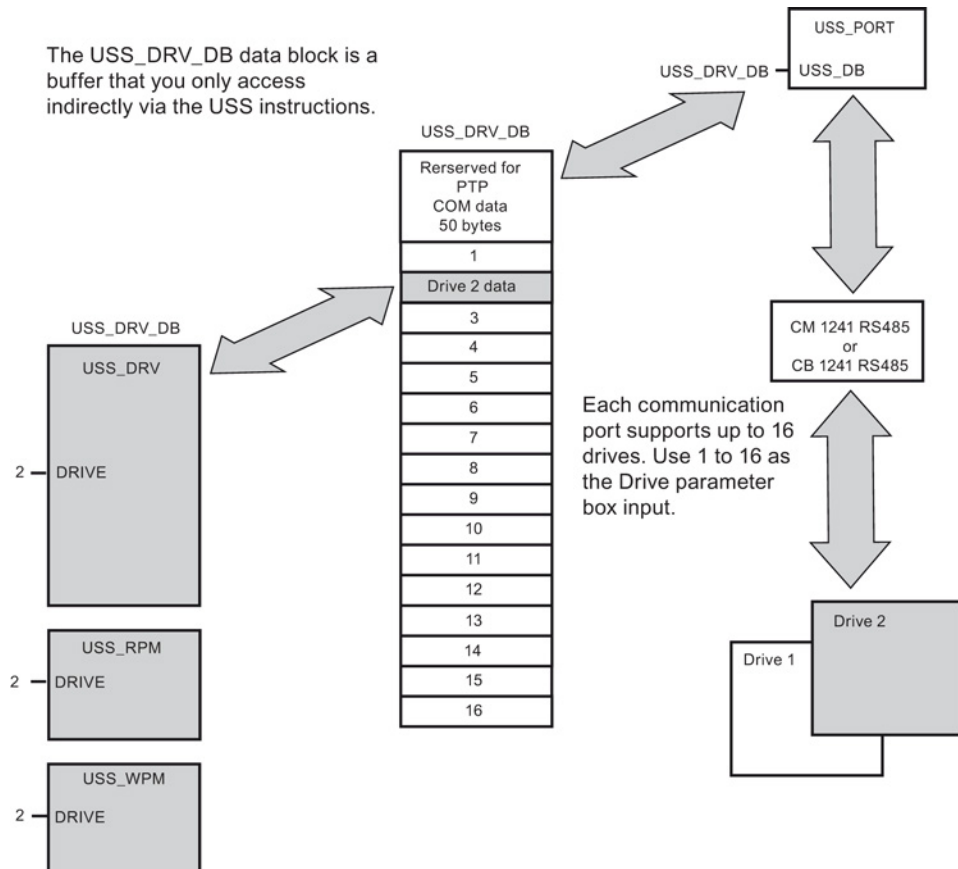

All drives (up to 16) connected to a single RS485 port are part of the same USS network. All drives connected to a different RS485 port are part of a different USS network. Each USS network is managed using a unique data block. All instructions associated with a single USS network must share this data block. This includes all USS_DRV, USS_PORT, USS_RPM, and USS_WPM instructions used to control all drives on a single USS network.

The USS_DRV instruction is a Function Block (FB). When you place the USS_DRV instruction into the program editor, you will be prompted by the "Call options" dialog to assign a DB for this FB. If this is the first USS_DRV instruction in this program for this USS network, then you can accept the default DB assignment (or change the name if you wish) and the new DB is created for you. If however this is not the first USS_DRV instruction for this channel, then you must use the drop-down list in the "Call options" dialog to select the DB name that was previously assigned for this USS network.

Instructions USS_PORT, USS_RPM, and USS_WPM are all Functions (FCs). No DB is assigned when you place these FCs in the editor. Instead, you must assign the appropriate DB reference to the "USS_DB" input of these instructions. Double-click on the parameter field and then click on the parameter helper icon to see the available DB names).

The USS_PORT function handles the actual communication between the CPU and the drives via the Point-to-Point (PtP) RS485 communication port. Each call to this function handles one communication with one drive. Your program must call this function fast enough to prevent a communication timeout by the drives. You may call this function in a main program cycle OB or any interrupt OB.

Typically, you should call the USS_PORT function from a cyclic interrupt OB. The cycle time of the cyclic interrupt OB should be set to about half of the minimum call interval (As an example, 1200 baud communication should use a cyclic time of 350 ms or less).

The USS_DRV function block provides your program access to a specified drive on the USS network. Its inputs and outputs are the status and controls for the drive. If there are 16 drives on the network, your program must have at least 16 USS_DRV calls, one for each drive. These blocks should be called at the rate that is required to control the operation of the drive.

You may only call the USS_DRV function block from a main program cycle OB.

 **CAUTION**

Considerations in calling USS instructions from OBs

Only call USS_DRV, USS_RPM, and USS_WPM from a main program cycle OB. The USS_PORT function can be called from any OB, usually from a cyclic interrupt OB.

Do not use instructions USS_DRV, USS_RPM, or USS_WPM in a higher priority OB than the corresponding USS_PORT instruction. For example, do not place the USS_PORT in the main and a USS_RPM in a cyclic interrupt OB. Failure to prevent interruption of USS_PORT execution can produce unexpected errors, which could result in personal injury.

The USS_RPM and USS_WPM functions read and write the remote drive operating parameters. These parameters control the internal operation of the drive. See the drive manual for the definition of these parameters. Your program can contain as many of these functions as necessary, but only one read or write request can be active per drive, at any given time. You may only call the USS_RPM and USS_WPM functions from a main program cycle OB.

Calculating the time required for communicating with the drive

Communications with the drive are asynchronous to the S7-1200 scan cycle. The S7-1200 typically completes several scans before one drive communications transaction is completed.

The USS_PORT interval is the time required for one drive transaction. The table below shows the minimum USS_PORT interval for each communication baud rate. Calling the USS_PORT function more frequently than the USS_PORT interval will not increase the number of transactions. The drive timeout interval is the amount of time that might be taken for a transaction, if communications errors caused 3 tries to complete the transaction. By default, the USS protocol library automatically does up to 2 retries on each transaction.

Table 12- 34 Calculating the time requirements

| Baud rate | Calculated minimum USS_PORT call Interval (milliseconds) | Drive message interval timeout per drive (milliseconds) |
|-----------|--|---|
| 1200 | 790 | 2370 |
| 2400 | 405 | 1215 |
| 4800 | 212.5 | 638 |
| 9600 | 116.3 | 349 |
| 19200 | 68.2 | 205 |
| 38400 | 44.1 | 133 |
| 57600 | 36.1 | 109 |
| 115200 | 28.1 | 85 |

12.4.2 USS_PORT (Edit communication via USS network) instruction

Table 12- 35 USS_PORT instruction

| LAD / FBD | SCL | Description |
|---|---|---|
|  | <pre>USS_PORT (PORT:=_uint_in_, BAUD:=_dint_in_, ERROR=>_bool_out_, STATUS=>_word_out_, USS_DB:= fbtref inout);</pre> | <p>The USS_PORT instruction handles communication over a USS network.</p> |

Table 12- 36 Data types for the parameters

| Parameter and type | Data type | Description |
|--------------------|-----------|-------------|
| PORT | IN | Port |
| BAUD | IN | DInt |
| USS_DB | INOUT | USS_BASE |
| ERROR | OUT | Bool |
| STATUS | OUT | Word |

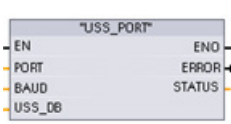

Typically, there is only one USS_PORT instruction per PtP communication port in the program, and each call of this function handles a transmission to or from a single drive. All USS functions associated with one USS network and PtP communication port must use the same instance DB.

12.4 Universal serial interface (USS) communication

Your program must execute the USS_PORT instruction often enough to prevent drive timeouts. USS_PORT is usually called from a cyclic interrupt OB to prevent drive timeouts and keep the most recent USS data updates available for USS_DRV calls.

12.4.3 USS_DRV (Swap data with drive) instruction

Table 12- 37 USS_DRV instruction

| LAD / FBD | SCL | Description |
|---|---|---|
| <p>Default view</p>  <p>Expanded view</p>  | <pre>"USS_DRV_DB" (RUN:=_bool_in_, OFF2:=_bool_in_, OFF3:=_bool_in_, F_ACK:=_bool_in_, DIR:=_bool_in_, DRIVE:=_usint_in_, PZD_LEN:=_usint_in_, SPEED_SP:=_real_in_, CTRL3:=_word_in_, CTRL4:=_word_in_, CTRL5:=_word_in_, CTRL6:=_word_in_, CTRL7:=_word_in_, CTRL8:=_word_in_, NDR=>_bool_out_, ERROR=>_bool_out_, STATUS=>_word_out_, RUN_EN=>_bool_out_, D_DIR=>_bool_out_, INHIBIT=>_bool_out_, FAULT=>_bool_out_, SPEED=>_real_out_, STATUS1=>_word_out_, STATUS3=>_word_out_, STATUS4=>_word_out_, STATUS5=>_word_out_, STATUS6=>_word_out_, STATUS7=>_word_out_, STATUS8=>_word_out_);</pre> | <p>The USS_DRV instruction exchanges data with a drive by creating request messages and interpreting the drive response messages. A separate function block should be used for each drive, but all USS functions associated with one USS network and PtP communication port must use the same instance data block. You must create the DB name when you place the first USS_DRV instruction and then reference the DB that was created by the initial instruction usage. STEP 7 automatically creates the DB when you insert the instruction.</p> |

¹ LAD and FBD: Expand the box to reveal all the parameters by clicking the bottom of the box. The parameter pins that are grayed are optional and parameter assignment is not required.

Table 12- 38 Data types for the parameters

| Parameter and type | | Data type | Description |
|--------------------|-----|-----------|--|
| RUN | IN | Bool | Drive start bit: When true, this input enables the drive to run at the preset speed. When RUN goes to false while a drive is running, the motor will be ramped down to a stop. This behavior differs from the dropping power (OFF2) or braking the motor (OFF3). |
| OFF2 | IN | Bool | Electrical stop bit: When false, this bit cause the drive to coast to a stop with no braking. |
| OFF3 | IN | Bool | Fast stop bit: When false, this bit causes a fast stop by braking the drive rather than just allowing the drive to coast to a stop. |
| F_ACK | IN | Bool | Fault acknowledge bit: This bit is set to reset the fault bit on a drive. The bit is set after the fault is cleared to indicate to the drive it no longer needs to indicate the previous fault. |
| DIR | IN | Bool | Drive direction control: This bit is set to indicate that the direction is forward (for positive SPEED_SP). |
| DRIVE | IN | USInt | Drive address: This input is the address of the USS drive. The valid range is drive 1 to drive 16. |
| PZD_LEN | IN | USInt | Word length: This is the number of words of PZD data. The valid values are 2, 4, 6, or 8 words. The default value is 2. |
| SPEED_SP | IN | Real | Speed set point: This is the speed of the drive as a percentage of configured frequency. A positive value specifies forward direction (when DIR is true). Valid range is 200.00 to -200.00. |
| CTRL3 | IN | Word | Control word 3: A value written to a user-configurable parameter on the drive. You must configure this on the drive. (optional parameter) |
| CTRL4 | IN | Word | Control word 4: A value written to a user-configurable parameter on the drive. You must configure this on the drive. (optional parameter) |
| CTRL5 | IN | Word | Control word 5: A value written to a user-configurable parameter on the drive. You must configure this on the drive. (optional parameter) |
| CTRL6 | IN | Word | Control word 6: A value written to a user-configurable parameter on the drive. You must configure this on the drive. (optional parameter) |
| CTRL7 | IN | Word | Control word 7: A value written to a user-configurable parameter on the drive. You must configure this on the drive. (optional parameter) |
| CTRL8 | IN | Word | Control word 8: A value written to a user-configurable parameter on the drive. You must configure this on the drive. (optional parameter) |
| NDR | OUT | Bool | New data ready: When true, the bit indicates that the outputs contain data from a new communication request. |
| ERROR | OUT | Bool | Error occurred: When true, this indicates that an error has occurred and the STATUS output is valid. All other outputs are set to zero on an error. Communication errors are only reported on the USS_PORT instruction ERROR and STATUS outputs. |
| STATUS | OUT | Word | The status value of the request indicates the result of the scan. This is not a status word returned from the drive. |
| RUN_EN | OUT | Bool | Run enabled: This bit indicates whether the drive is running. |
| D_DIR | OUT | Bool | Drive direction: This bit indicates whether the drive is running forward. |
| INHIBIT | OUT | Bool | Drive inhibited: This bit indicates the state of the inhibit bit on the drive. |
| FAULT | OUT | Bool | Drive fault: This bit indicates that the drive has registered a fault. You must fix the problem and then set the F_ACK bit to clear this bit when set. |

12.4 Universal serial interface (USS) communication

| Parameter and type | | Data type | Description |
|--------------------|-----|-----------|---|
| SPEED | OUT | Real | Drive Current Speed (scaled value of drive status word 2): The value of the speed of the drive as a percentage of configured speed. |
| STATUS1 | OUT | Word | Drive Status Word 1: This value contains fixed status bits of a drive. |
| STATUS3 | OUT | Word | Drive Status Word 3: This value contains a user-configurable status word on the drive. |
| STATUS4 | OUT | Word | Drive Status Word 4: This value contains a user-configurable status word on the drive. |
| STATUS5 | OUT | Word | Drive Status Word 5: This value contains a user-configurable status word on the drive. |
| STATUS6 | OUT | Word | Drive Status Word 6: This value contains a user-configurable status word on the drive. |
| STATUS7 | OUT | Word | Drive Status Word 7: This value contains a user-configurable status word on the drive. |
| STATUS8 | OUT | Word | Drive Status Word 8: This value contains a user-configurable status word on the drive. |

When the initial USS_DRV execution occurs, the drive indicated by the USS address (parameter DRIVE) is initialized in the Instance DB. After this initialization, subsequent executions of USS_PORT can begin communication to the drive at this drive number.

Changing the drive number requires a CPU STOP-to-RUN mode transition that initializes the instance DB. Input parameters are configured into the USS TX message buffer and outputs are read from a "previous" valid response buffer if any exists. There is no data transmission during USS_DRV execution. Drives communicate when USS_PORT is executed. USS_DRV only configures the messages to be sent and interprets data that might have been received from a previous request.

You can control the drive direction of rotation using either the DIR input (Bool) or using the sign (positive or negative) with the SPEED_SP input (Real). The following table indicates how these inputs work together to determine the drive direction, assuming the motor is wired for forward rotation.

Table 12- 39 Interaction of the SPEED_SP and DIR parameters

| SPEED_SP | DIR | Drive rotation direction |
|-----------|-----|--------------------------|
| Value > 0 | 0 | Reverse |
| Value > 0 | 1 | Forward |
| Value < 0 | 0 | Forward |
| Value < 0 | 1 | Reverse |

12.4.4 USS_RPM (Readout parameters from the drive) instruction

Table 12- 40 USS_RPM instruction

| LAD / FBD | SCL | Description |
|---|---|--|
|  | <pre>USS_RPM(REQ:=_bool_in_, DRIVE:=_usint_in_, PARAM:=_uint_in_, INDEX:=_uint_in_, DONE=>_bool_out_, ERROR=>_bool_out_, STATUS=>_word_out_, VALUE=>_variant_out_, USS_DB:=_fbtref_inout_);</pre> | <p>The USS_RPM instruction reads a parameter from a drive. All USS functions associated with one USS network and PtP communication port must use the same data block. USS_RPM must be called from a main program cycle OB.</p> |

Table 12- 41 Data types for the parameters

| Parameter type | | Data type | Description |
|-------------------|-------|--|---|
| REQ | IN | Bool | Send request: When true, REQ indicates that a new read request is desired. This is ignored if the request for this parameter is already pending. |
| DRIVE | IN | USInt | Drive address: DRIVE is the address of the USS drive. The valid range is drive 1 to drive 16. |
| PARAM | IN | UInt | Parameter number: PARAM designates which drive parameter is written. The range of this parameter is 0 to 2047. On some drives, the most significant byte can access PARAM values greater than 2047. See your drive manual for details on how to access an extended range. |
| INDEX | IN | UInt | Parameter index: INDEX designates which Drive Parameter index is to be written. A 16-bit value where the Least Significant Byte is the actual index value with a range of (0 to 255). The Most Significant Byte may also be used by the drive and is drive-specific. See your drive manual for details. |
| USS_DB | INOUT | USS_BASE | The name of the instance DB that is created and initialized when a USS_DRV instruction is placed in your program. |
| VALUE | IN | Word, Int, UInt, DWord, DInt, UDIInt, Real | This is the value of the parameter that was read and is valid only when the DONE bit is true. |
| DONE ¹ | OUT | Bool | When true, indicates that the VALUE output holds the previously requested read parameter value. This bit is set when USS_DRV sees the read response data from the drive. This bit is reset when either: you request the response data via another USS_RPM poll, or on the second of the next two calls to USS_DRV |

12.4 Universal serial interface (USS) communication

| Parameter type | | Data type | Description |
|----------------|-----|-----------|---|
| ERROR | OUT | Bool | Error occurred: When true, ERROR indicates that an error has occurred and the STATUS output is valid. All other outputs are set to zero on an error. Communication errors are only reported on the USS_PORT instruction ERROR and STATUS outputs. |
| STATUS | OUT | Word | STATUS indicates the result of the read request. Additional information is available in the "USS_Extended_Error" variable for some status codes. |

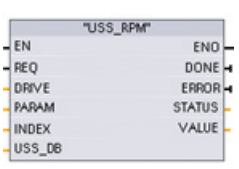
¹ The DONE bit indicates that valid data has been read from the referenced motor drive and delivered to the CPU. It does not indicate that the USS library is capable of immediately reading another parameter. A blank PKW request must be sent to the motor drive and must also be acknowledged by the instruction before the parameter channel for the specific drive becomes available for use. Immediately calling a USS_RPM or USS_WPM FC for the specified motor drive will result in a 0x818A error.

12.4.5 USS_WPM (Change parameters in the drive) instruction

Note

EEPROM write operations (for the EEPROM inside a USS drive)

Do not overuse the EEPROM permanent write operation. Minimize the number of EEPROM write operations to extend the EEPROM life.

Table 12- 42 USS_WPM instruction

| LAD / FBD | SCL | Description |
|-----------|--|--|
| | <pre>USS_WPM(REQ:=_bool_in_, DRIVE:=_usint_in_, PARAM:=_uint_in_, INDEX:=_uint_in_, EEPROM:=_bool_in_, VALUE:=_variant_in_, DONE=>_bool_out_, ERROR=>_bool_out_, STATUS=>_word_out_, USS_DB:=_fbtref_inout_);</pre> | <p>The USS_WPM instruction modifies a parameter in the drive. All USS functions associated with one USS network and PtP communication port must use the same data block.</p> <p>USS_WPM must be called from a main program cycle OB.</p> |

Table 12- 43 Data types for the parameters

| Parameter and type | | Data type | Description |
|--------------------|-------|--|---|
| REQ | IN | Bool | Send request: When true, REQ indicates that a new write request is desired. This is ignored if the request for this parameter is already pending. |
| DRIVE | IN | USInt | Drive address: DRIVE is the address of the USS drive. The valid range is drive 1 to drive 16. |
| PARAM | IN | UInt | Parameter number: PARAM designates which drive parameter is written. The range of this parameter is 0 to 2047. On some drives, the most significant byte can access PARAM values greater than 2047. See your drive manual for details on how to access an extended range. |
| INDEX | IN | UInt | Parameter index: INDEX designates which Drive Parameter index is to be written. A 16-bit value where the least significant byte is the actual index value with a range of (0 to 255). The most significant byte may also be used by the drive and is drive-specific. See your drive manual for details. |
| EEPROM | IN | Bool | Store To Drive EEPROM: When true, a write drive parameter transaction will be stored in the drive EEPROM. If false, the write is temporary and will not be retained if the drive is power cycled. |
| VALUE | IN | Word, Int, UInt, DWord, DInt, UInt, Real | The value of the parameter that is to be written. It must be valid on the transition of REQ. |
| USS_DB | INOUT | USS_BASE | The name of the instance DB that is created and initialized when a USS_DRV instruction is placed in your program. |
| DONE ¹ | OUT | Bool | When true, DONE indicates that the input VALUE has been written to the drive. This bit is set when USS_DRV sees the write response data from the drive. This bit is reset when either you request the response data via another USS_WPM poll, or on the second of the next two calls to USS_DRV |
| ERROR | OUT | Bool | When true, ERROR indicates that an error has occurred and the STATUS output is valid. All other outputs are set to zero on an error. Communication errors are only reported on the USS_PORT instruction ERROR and STATUS outputs. |
| STATUS | OUT | Word | STATUS indicates the result of the write request. Additional information is available in the "USS_Extended_Error" variable for some status codes. |

¹ The DONE bit indicates that valid data has been read from the referenced motor drive and delivered to the CPU. It does not indicate that the USS library is capable of immediately reading another parameter. A blank PKW request must be sent to the motor drive and must also be acknowledged by the instruction before the parameter channel for the specific drive becomes available for use. Immediately calling a USS_RPM or USS_WPM FC for the specified motor drive will result in a 0x818A error.

12.4.6 USS status codes

USS instruction status codes are returned at the STATUS output of the USS functions.

Table 12- 44 STATUS codes ¹

| STATUS (W#16#....) | Description |
|--------------------|---|
| 0000 | No error |
| 8180 | The length of the drive response did not match the characters received from the drive. The drive number where the error occurred is returned in the "USS_Extended_Error" variable. See the extended error description below this table. |
| 8181 | VALUE parameter was not a Word, Real or DWord data type. |
| 8182 | The user supplied a Word for a parameter value and received a DWord or Real from the drive in the response. |
| 8183 | The user supplied a DWord or Real for a parameter value and received a Word from the drive in the response. |
| 8184 | The response telegram from drive had a bad checksum. The drive number where the error occurred is returned in the "USS_Extended_Error" variable. See the extended error description below this table. |
| 8185 | Illegal drive address (valid drive address range: 1 to16) |
| 8186 | The speed set point is out of the valid range (valid speed SP range: -200% to 200%). |
| 8187 | The wrong drive number responded to the request sent. The drive number where the error occurred is returned in the "USS_Extended_Error" variable. See the extended error description below this table. |
| 8188 | Illegal PZD word length specified (valid range = 2, 4, 6 or 8 words) |
| 8189 | Illegal Baud Rate was specified. |
| 818A | The parameter request channel is in use by another request for this drive. |
| 818B | The drive has not responded to requests and retries. The drive number where the error occurred is returned in the "USS_Extended_Error" variable. See the extended error description below this table. |
| 818C | The drive returned an extended error on a parameter request operation. See the extended error description below this table. |
| 818D | The drive returned an illegal access error on a parameter request operation. See your drive manual for information of why parameter access may be limited. |
| 818E | The drive has not been initialized. This error code is returned to USS_RPM or USS_WPM when USS_DRV, for that drive, has not been called at least once. This keeps the initialization on first scan of USS_DRV from overwriting a pending parameter read or write request, since it initializes the drive as a new entry. To fix this error, call USS_DRV for this drive number. |
| 80Ax-80Fx | Specific errors returned from PtP communication FBs called by the USS Library - These error code values are not modified by the USS library and are defined in the PtP instruction descriptions. |

¹ In addition to the USS instruction errors listed above, errors can be returned from the underlying PtP communication instructions.

For several STATUS codes, additional information is provided in the "USS_Extended_Error" variable of the USS_DRV Instance DB. For STATUS codes hexadecimal 8180, 8184, 8187, and 818B, USS_Extended_Error contains the drive number where the communication error occurred. For STATUS code hexadecimal 818C, USS_Extended_Error contains a drive error code returned from the drive when using a USS_RPM or USS_WPM instruction.

Communication errors (STATUS = 16#818B) are only reported on the USS_PORT instruction and not on the USS_DRV instruction. For example, if the network is not properly terminated then it is possible for a drive to go to RUN but the USS_DRV instruction will show all 0's for the output parameters. In this case, you can only detect the communication error on the USS_PORT instruction. Since this error is only visible for one scan, you will need to add some capture logic as illustrated in the following example. In this example, when the error bit of the USS_PORT instruction is TRUE, then the STATUS and the USS_Extended_Error values are saved into M memory. The drive number is placed in USS_Extended_Error variable when the STATUS code value is hexadecimal 8180, 8184, 8187, or 818B.

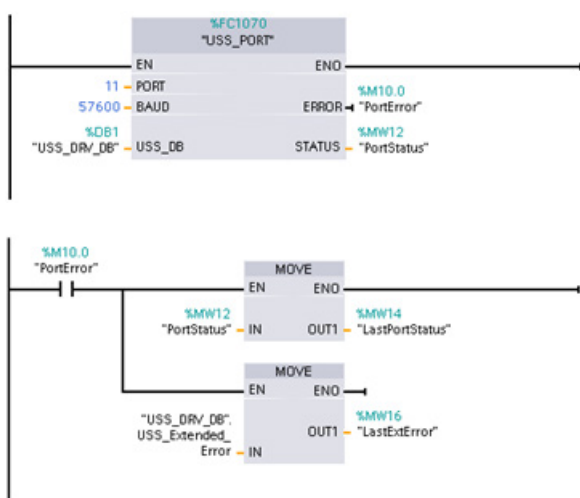

Network 1 "PortStatus" port status and "USS_DRV_DB".USS_Extended_Error extended error code values are only valid for one program scan. The values must be captured for later processing.

Network 2 The "PortError" contact triggers the storage of the "PortStatus" value in "LastPortStatus" and the "USS_DRV_DB".USS_Extended_Error value in "LastExtError".

USS drives support read and write access to a drive's internal parameters. This feature allows remote control and configuration of the drive. Drive parameter access operations can fail due to errors such as values out of range or illegal requests for a drive's current mode. The drive generates an error code value that is returned in the "USS_Extended_Error" variable. This error code value is only valid for the last execution of a USS_RPM or USS_WPM instruction. The drive error code is put into USS_Extended_Error variable when the STATUS code value is hexadecimal 818C. The error code value of "USS_Extended_Error" depends on the drive model. See the drive's manual for a description of the extended error codes for read and write parameter operations.

12.4.7 General drive setup information

General drive setup requirements

- The drives must be set to use 4 PKW words.
- The drives can be configured for 2, 4, 6, or 8 PZD words.
- The number of PZD word's in the drive must match PZD_LEN input on the USS_DRV instruction for that drive.
- The baud rate in all the drives must match the BAUD input on the USS_PORT instruction.
- The drive must be set for remote control.
- The drive must be set for frequency set-point to USS on COM Link.
- The drive address must be set to 1 to 16 and match the DRIVE input on the USS_DRV block for that drive.
- The drive direction control must be set to use the polarity of the drive set-point.
- The RS485 network must be terminated properly.

Connecting a MicroMaster drive

This information about SIEMENS MicroMaster drives is provided as an example. For other drives, refer to the drive's manual for setup instructions.

To make the connection to a MicroMaster Series 4 (MM4) drive, insert the ends of the RS485 cable into the two caged-clamp, screw-less terminals provided for USS operation. Standard PROFIBUS cable and connectors can be used to connect the S7-1200.

| |
|--|
|  CAUTION |
| Interconnecting equipment with different reference potentials can cause unwanted currents to flow through the interconnecting cable |
| These unwanted currents can cause communications errors or damage equipment. Be sure all equipment that you are about to connect with a communications cable either shares a common circuit reference or is isolated to prevent unwanted current flows. The shield must be tied to chassis ground or pin 1 on the 9-pin connector. It is recommended that you tie wiring terminal 2--0 V on the MicroMaster drive to chassis ground. |

The two wires at the opposite end of the RS485 cable must be inserted into the MM4 drive terminal blocks. To make the cable connection on a MM4 drive, remove the drive cover(s) to access the terminal blocks. See the MM4 user manual for details about how to remove the covers(s) of your specific drive.

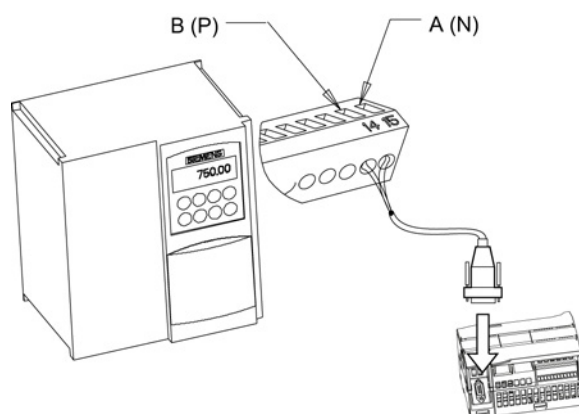

The terminal block connections are labeled numerically. Using a PROFIBUS connector on the S7-1200 side, connect the A terminal of the cable to the drive terminal 15 (for an MM420) or terminal 30 (MM440). Connect the B terminal of B (P) A (N) the cable connector to terminal 14 (MM420) or terminal 29 (MM440).

If the S7-1200 is a terminating node in the network, or if the connection is point-to-point, it is necessary to use terminals A1 and B1 (not A2 and B2) of the connector since they allow the termination settings to be set (for example, with DP connector type 6ES7 972--0BA40--0X40).

| | |
|--|----------------|
| | CAUTION |
| Replace drive covers properly before supplying power | |
| Make sure the drive covers are replaced properly before supplying power to the unit. | |

If the drive is configured as the terminating node in the network, then termination and bias resistors must also be wired to the appropriate terminal connections. This diagram shows examples of the MM4 drive connections necessary for termination and bias.

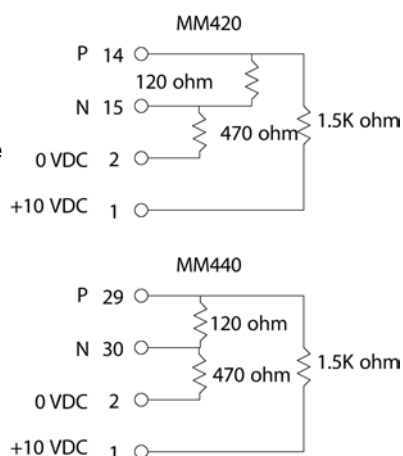

Setting up the MM4 drive

Before you connect a drive to the S7-1200, you must ensure that the drive has the following system parameters. Use the keypad on the drive to set the parameters:

| | |
|--|--|
| 1. Reset the drive to factory settings (optional). | P0010=30 P0970=1 |
| If you skip step 1, then ensure that these parameters are set to the indicated values. | USS PZD length = P2012 Index 0=(2, 4, 6, or 8) USS PKW length = P2013 Index 0=4 |
| 2. Enable the read/write access to all parameters (Expert mode). | P0003=3 |
| 3. Check the motor settings for your drive. The settings will vary according to the motor(s) being used. To set the parameters P304, P305, P307, P310, and P311, you must first set parameter P010 to 1 (quick commissioning mode). When you are finished setting the parameters, set parameter P010 to 0. Parameters P304, P305, P307, P310, and P311 can only be changed in the quick commissioning mode. | P0304 = Rated motor voltage (V) P0305 = Rated motor current (A) P0307 = Rated motor power (W) P0310 = Rated motor frequency (Hz) P0311 = Rated motor speed |
| 4. Set the local/remote control mode. | P0700 Index 0=5 |
| 5. Set selection of frequency set-point to USS on COM link. | P1000 Index 0=5 |
| 6. Ramp up time (optional) This is the time in seconds that it takes the motor to accelerate to maximum frequency. | P1120=(0 to 650.00) |
| 7. Ramp down time (optional) This the time in seconds that it takes the motor to decelerate to a complete stop. | P1121=(0 to 650.00) |
| 8. Set the serial link reference frequency: | P2000=(1 to 650 Hz) |
| 9. Set the USS normalization: | P2009 Index 0=0 |
| 10. Set the baud rate of the RS485 serial interface: | P2010 Index 0= 4 (2400 baud) 5 (4800 baud) 6 (9600 baud) 7 (19200 baud) 8 (38400 baud) 9 (57600 baud) 12 (115200 baud) |
| 11. Enter the Slave address. Each drive (a maximum of 31) can be operated over the bus. | P2011 Index 0=(0 to 31) |
| 12. Set the serial link timeout. This is the maximum permissible period between two incoming data telegrams. This feature is used to turn off the inverter in the event of a communications failure. Timing starts after a valid data telegram has been received. If a further data telegram is not received within the specified time period, the inverter will trip and display fault code F0070. Setting the value to zero switches off the control. | P2014 Index 0=(0 to 65,535 ms) 0=timeout disabled |
| 13. Transfer the data from RAM to EEPROM: | P0971=1 (Start transfer) Save the changes to the parameter settings to EEPROM |

12.5 Modbus communication

12.5.1 Overview of Modbus RTU and TCP communication Modbus TCP instructions V13

Modbus function codes

- A CPU operating as a Modbus RTU master (or Modbus TCP client) can read/write both data and I/O states in a remote Modbus RTU slave (or Modbus TCP server). Remote data can be read and then processed in your program logic.
- A CPU operating as a Modbus RTU slave (or Modbus TCP server) allows a supervisory device to read/write both data and I/O states in CPU memory. A RTU master (or Modbus TCP client) can write new values into slaver/server CPU memory, that are available for your program logic.

| |
|--|
|  WARNING |
| If an attacker can physically access your networks, the attacker can possibly read and write data. |
| The TIA Portal, the CPU, and HMIs (except HMIs using GET/PUT) use secure communication that protects against replay and "man-in-the-middle" attacks. Once communication is enabled, the exchange of signed messages takes place in clear text which allows an attacker to read data, but protects against unauthorized writing of data. The TIA Portal, not the communication process, encrypts the data of know-how protected blocks. |
| All other forms of communication (I/O exchange through PROFIBUS, PROFINET, AS-i, or other I/O bus, GET/PUT, T-Block, and communication modules (CM)) have no security features. You must protect these forms of communication by limiting physical access. If an attacker can physically access your networks utilizing these forms of communication, the attacker can possibly read and write data. |
| For security information and recommendations, please see our "Operational Guidelines for Industrial Security" (http://www.industry.siemens.com/topics/global/en/industrial-security/Documents/operational_guidelines_industrial_security_en.pdf) in the Siemens Service and Support site. |

Table 12- 45 Read data functions: Read remote I/O and program data

| Modbus function code | Read slave (server) functions - standard addressing |
|----------------------|---|
| 01 | Read output bits: 1 to 2000 bits per request |
| 02 | Read input bits: 1 to 2000 bits per request |
| 03 | Read Holding registers: 1 to 125 words per request |
| 04 | Read input words: 1 to 125 words per request |

Table 12- 46 Write data functions: Write remote I/O and modify program data

| Modbus function code | Write slave (server) functions - standard addressing |
|----------------------|---|
| 05 | Write one output bit: 1 bit per request |
| 06 | Write one holding register: 1 word per request |
| 15 | Write one or more output bits: 1 to 1968 bits per request |
| 16 | Write one or more holding registers: 1 to 123 words per request |

- Modbus function codes 08 and 11 provide slave device communication diagnostic information.
- Modbus function code 0 broadcasts a message to all slaves (with no slave response). The broadcast function is not available for Modbus TCP, because communication is connection based.

Table 12- 47 Modbus network station addresses

| Station | | Address |
|-------------|--------------------------|----------------------------|
| RTU station | Standard station address | 1 to 247 |
| | Extended station address | 1 to 65535 |
| TCP station | Station address | IP address and port number |

Modbus memory addresses

The actual number of Modbus memory addresses available depends on the CPU model, how much work memory exists, and how much CPU memory is used by other program data. The table below gives the nominal value of the address range.

Table 12- 48 Modbus memory addresses

| Station | | Address range |
|-------------|-------------------------|---------------|
| RTU station | Standard memory address | 10K |
| | Extended memory address | 64K |
| TCP station | Standard memory address | 10K |

Modbus RTU communication

Modbus RTU (Remote Terminal Unit) is a standard network communication protocol that uses the RS232 or RS485 electrical connection for serial data transfer between Modbus network devices. You can add PtP (Point to Point) network ports to a CPU with a RS232 or RS485 CM or a RS485 CB.

Modbus RTU uses a master/slave network where all communications are initiated by a single Master device and slaves can only respond to a master’s request. The master sends a request to one slave address and only that slave address responds to the command.

Modbus TCP communication

Modbus TCP (Transmission Control Protocol) is a standard network communication protocol that uses the PROFINET connector on the CPU for TCP/IP communication. No additional communication hardware module is required.

Modbus TCP uses Open User Communications (OUC) connections as a Modbus communication path. Multiple client-server connections may exist, in addition to the connection between STEP 7 and the CPU. Mixed client and server connections are supported up to the maximum number of connections allowed by the CPU model (Page 511).

Each MB_SERVER connection must use a unique instance DB and IP port number. Only 1 connection per IP port is supported. Each MB_SERVER (with its unique instance DB and IP port) must be executed individually for each connection.

A Modbus TCP client (master) must control the client-server connection with the DISCONNECT parameter. The basic Modbus client actions are shown below.

1. Initiate a connection to a particular server (slave) IP address and IP port number
2. Initiate client transmission of a Modbus messages and receive the server responses
3. When desired, initiate the disconnection of client and server to enable connection with a different server.

Modbus RTU instructions in your program

- MB_COMM_LOAD: One execution of MB_COMM_LOAD is used to set up PtP port parameters like baud rate, parity, and flow control. After a CPU port is configured for the Modbus RTU protocol, it can only be used by either the MB_MASTER or MB_SLAVE instructions.
- MB_MASTER: The Modbus master instruction enables the CPU to act as a Modbus RTU master device and communicate with one or more Modbus slave devices.
- MB_SLAVE: The Modbus slave instruction enables the CPU to act as a Modbus RTU slave device and communicate with a Modbus master device.

Modbus TCP instructions in your program

- MB_CLIENT: Make client-server TCP connection, send command message, receive response, and control the disconnection from the server
- MB_SERVER: Connect to a Modbus TCP client upon request, receive Modbus message, and send response

12.5.2 Modbus TCP

12.5.2.1 MB_CLIENT (Communicate via PROFINET as Modbus TCP client) instruction

Table 12- 49 MB_CLIENT instruction

| LAD / FBD | SCL | Description |
|-----------|--|--|
| | <pre>"MB_CLIENT_DB" (REQ:= bool_in_, DISCONNECT:= bool_in_, CONNECT_ID:= uint_in_, IP_OCTET_1:= byte_in_, IP_OCTET_2:= byte_in_, IP_OCTET_3:= byte_in_, IP_OCTET_4:= byte_in_, IP_PORT:= uint_in_, MB_MODE:= usint_in_, MB_DATA_ADDR:= udint_in_, MB_DATA_LEN:= uint_in_, DONE=> bool_out_, BUSY=> bool_out_, ERROR=> bool_out_, STATUS=> word_out_, MB_DATA_PTR:= variant inout);</pre> | <p>MB_CLIENT communicates as a Modbus TCP client through the PROFINET connector on the S7-1200 CPU. No additional communication hardware module is required.</p> <p>MB_CLIENT can make a client-server connection, send a Modbus function request, receive a response, and control the disconnection from a Modbus TCP server.</p> |

Table 12- 50 Data types for the parameters

| Parameter and type | Data type | Description |
|--------------------|-----------|--|
| REQ In | Bool | FALSE = No Modbus communication request TRUE = Request to communicate with a Modbus TCP server |
| DISCONNECT IN | Bool | The DISCONNECT parameter allows your program to control connection and disconnection with a Modbus server device. If DISCONNECT = 0 and a connection does not exist, then MB_CLIENT attempts to make a connection to the assigned IP address and port number. If DISCONNECT = 1 and a connection exists, then a disconnect operation is attempted. Whenever this input is enabled, no other operation will be attempted. |
| CONNECT_ID IN | UInt | The CONNECT_ID parameter must uniquely identify each connection within the PLC. Each unique instance of the MB_CLIENT or MB_SERVER instruction must contain a unique CONNECT_ID parameter. |
| IP_OCTET_1 IN | USInt | Modbus TCP server IP address: Octet 1 8-bit part of the 32-bit IPv4 IP address of the Modbus TCPserver to which the client will connect and communicate using the Modbus TCP protocol. |
| IP_OCTET_2 IN | USInt | Modbus TCP server IP address: Octet 2 |
| IP_OCTET_3 IN | USInt | Modbus TCP server IP address: Octet 3 |
| IP_OCTET_4 IN | USInt | Modbus TCP server IP address: Octet 4 |
| IP_PORT IN | UInt | Default value = 502: The IP port number of the server to which the client will attempt to connect and ultimately communicate using the TCP/IP protocol. |

| Parameter and type | | Data type | Description |
|--------------------|--------|-----------|--|
| MB_MODE | IN | USInt | Mode Selection: Assigns the type of request (read, write, or diagnostic). See the Modbus functions table below for details. |
| MB_DATA_ADDR | IN | UDInt | Modbus starting Address: Assigns the starting address of the data to be accessed by MB_CLIENT. See the Modbus functions table below for valid addresses. |
| MB_DATA_LEN | IN | UInt | Modbus data Length: Assigns the number of bits or words to be accessed in this request. See the Modbus functions table below for valid lengths |
| MB_DATA_PTR | IN_OUT | Variant | Pointer to the Modbus data register: The register buffers data going to or coming from a Modbus server. The pointer must assign a standard global DB or a M memory address. |
| DONE | OUT | Bool | The DONE bit is TRUE for one scan, after the last request was completed with no error. |
| BUSY | OUT | Bool | <ul style="list-style-type: none"> • 0 - No MB_CLIENT operation in progress • 1 - MB_CLIENT operation in progress |
| ERROR | OUT | Bool | The ERROR bit is TRUE for one scan, after the MB_CLIENT execution was terminated with an error. The error code value at the STATUS parameter is valid only during the single cycle where ERROR = TRUE. |
| STATUS | OUT | Word | Execution condition code |

REQ parameter

FALSE = No Modbus communication request

TRUE = Request to communicate with a Modbus TCP server

If no instance of MB_CLIENT is active and parameter DISCONNECT=0, when REQ=1 a new Modbus request will start. If the connection is not already established then a new connection will be made.

If the same instance of MB_CLIENT is executed again with DISCONNECT=0 and REQ=1, before the completion of the current request, then no subsequent Modbus transmission will be made. However, as soon as the current request is completed, a new request can be processed if MB_CLIENT is executed with REQ=1.

When the current MB_CLIENT communication request is complete, the DONE bit is TRUE for one cycle. The DONE bit can be used as a time gate to sequence multiple MB_CLIENT requests.

Note

Input data consistency during MB_CLIENT processing

Once a Modbus client initiates a Modbus operation, all the input states are saved internally and are then compared on each successive call. The comparison is used to determine if this particular call was the originator of the active client request. More than one MB_CLIENT call can be performed using a common instance DB.

As a result, it is important that the inputs are not changed during the period of time that a MB_CLIENT operation is actively being processed. If this rule is not followed, then a MB_CLIENT cannot determine that it is the active instance.

MB_MODE and MB_DATA_ADDR parameters select the Modbus communication function

MB_DATA_ADDR assigns the starting Modbus address of the data to be accessed. The MB_CLIENT instruction uses a MB_MODE input rather than a function code input.

The combination of MB_MODE and MB_DATA_ADDR values determine the function code that is used in the actual Modbus message. The following table shows the correspondence between parameter MB_MODE, Modbus function, and Modbus address range.

Table 12- 51 Modbus functions

| MB_MODE | Modbus function | Data length | Operation and data | MB_DATA_ADDR |
|---------|-----------------|-------------|---|---------------------------------------|
| 0 | 01 | 1 to 2000 | Read output bits: 1 to 2000 bits per request | 1 to 9999 |
| 0 | 02 | 1 to 2000 | Read input bits: 1 to 2000 bits per request | 10001 to 19999 |
| 0 | 03 | 1 to 125 | Read Holding registers: 1 to 125 words per request | 40001 to 49999 or 400001 to 465535 |
| 0 | 04 | 1 to 125 | Read input words: 1 to 125 words per request | 30001 to 39999 |
| 1 | 05 | 1 | Write one output bit: One bit per request | 1 to 9999 |
| 1 | 06 | 1 | Write one holding register: 1 word per request | 40001 to 49999 or 400001 to 465535 |
| 1 | 15 | 2 to 1968 | Write multiple output bits: 2 to 1968 bits per request | 1 to 9999 |
| 1 | 16 | 2 to 123 | Write multiple holding registers: 2 to 123 words per request | 40001 to 49999 or 400001 to 465535 |
| 2 | 15 | 1 to 1968 | Write one or more output bits: 1 to 1968 bits per request | 1 to 9999 |
| 2 | 16 | 1 to 123 | Write one or more holding registers: 1 to 123 words per request | 40001 to 49999 or 400001 to 465535 |
| 11 | 11 | 0 | Read the server communication status word and event counter. The status word indicates busy (0 – not busy, 0xFFFF - busy). The event counter is incremented for each successful completion of a message. Both the MB_DATA_ADDR and MB_DATA_LEN parameters of MB_CLIENT are ignored for this function. | |
| 80 | 08 | 1 | Check server status using data diagnostic code 0x0000 (Loopback test – server echoes the request) 1 word per request | |

| MB_MODE | Modbus function | Data length | Operation and data | MB_DATA_ADDR |
|------------------------------------|-----------------|-------------|--|--------------|
| 81 | 08 | 1 | Reset server event counter using data diagnostic code 0x000A 1 word per request | |
| 3 to 10, 12 to 79, 82 to 255 | | | Reserved | |

Note**MB_DATA_PTR assigns a buffer to store data read/written to/from a Modbus TCP server**

The data buffer can be in a standard global DB or M memory address.

For a buffer in M memory, use the standard Any Pointer format. This is in the format P#"Bit Address" "Data Type" "Length", an example would be P#M1000.0 WORD 500.

MB_DATA_PTR assigns a communication buffer

- MB_CLIENT communication functions:
 - Read and write 1-bit data from Modbus server addresses (00001 to 09999)
 - Read 1-bit data from Modbus server addresses (10001 to 19999)
 - Read 16-bit word data from Modbus server addresses (30001 to 39999) and (40001 to 49999)
 - Write 16-bit word data to Modbus server addresses (40001 to 49999)
- Word or bit sized data is transferred to/from the DB or M memory buffer assigned by MB_DATA_PTR.
- If a DB is assigned as the buffer by MB_DATA_PTR, then you must assign data types to all DB data elements.
 - The 1-bit Bool data type represents one Modbus bit address
 - 16-bit single word data types like WORD, UInt, and Int represent one Modbus word address
 - 32-bit double word data types like DWORD, DInt, and Real represent two Modbus word addresses

- Complex DB elements can be assigned by MB_DATA_PTR, such as
 - Standard arrays
 - Named structures where each element is unique.
 - Named complex structures where each element has a unique name and a 16 or 32 bit data type.
- There is no requirement that the MB_DATA_PTR data areas be in the same global data block (or M memory area). You can assign one data block for Modbus reads, another data block for Modbus writes, or one data block for each MB_CLIENT station.

Multiple client connections

A Modbus TCP client can support concurrent connections up to the maximum number of Open User Communications connections allowed by the PLC. The total number of connections for a PLC, including Modbus TCP Clients and Servers, must not exceed the maximum number of supported Open User Communications connections (Page 511). The Modbus TCP connections may be shared between Client and/or Server type connections.

Individual client connections must follow these rules:

- Each MB_CLIENT connection must use a distinct instance DB
- Each MB_CLIENT connection must specify a unique server IP address
- Each MB_CLIENT connection must specify a unique connection ID
- Unique IP port numbers may or may not be required depending upon the server configuration

The Connection ID must be unique for each individual connection. This means a single, unique Connection ID must only be used with each individual instance DB. In summary, the instance DB and the Connection ID are paired together and must be unique for every connection.

Table 12- 52 MB_CLIENT instance data block user accessible static variables

| Variable | Data type | Default | description |
|----------------------|-----------|---------|---|
| Blocked_Proc_Timeout | Real | 3.0 | Amount of time (in seconds) to wait upon a blocked Modbus client instance before removing this instance as being ACTIVE. This can occur, for example, when a client request has been issued and then application stops executing the client function before it has completely finished the request. The maximum S7-1200 limit is 55 seconds. |
| MB_Unit_ID | Word | 255 | Modbus unit identifier: A Modbus TCP server is addressed using its IP address. As a result, the MB_UNIT_ID parameter is not used for Modbus TCP addressing. The MB_UNIT_ID parameter corresponds to the slave address in the Modbus RTU protocol. If a Modbus TCP server is used for a gateway to a Modbus RTU protocol, the MB_UNIT_ID can be used to identify the slave device connected on the serial network. The MB_UNIT_ID would be used to forward the request to the correct Modbus RTU slave address. Some Modbus TCP devices may require the MB_UNIT_ID parameter to be initialized within a restricted range of values. |

| Variable | Data type | Default | description |
|-------------|-----------|---------|---|
| RCV_TIMEOUT | Real | 2.0 | Time in seconds that the MB_CLIENT waits for a server to respond to a request. |
| Connected | Bool | 0 | Indicates whether the connection to the assigned server is connected or disconnected: 1=connected, 0=disconnected |

Table 12- 53 MB_CLIENT protocol errors

| STATUS (W#16#) | Response code to Modbus client (B#16#) | Modbus protocol errors |
|----------------|--|---|
| 8381 | 01 | Function code not supported |
| 8382 | 03 | Data length error |
| 8383 | 02 | Data address error or access outside the bounds of the MB_HOLD_REG address area |
| 8384 | 03 | Data value error |
| 8385 | 03 | Data diagnostic code value not supported (function code 08) |

Table 12- 54 MB_CLIENT execution condition codes ¹

| STATUS (W#16#) | MB_CLIENT parameter errors |
|----------------|--|
| 7001 | MB_CLIENT is waiting for a Modbus server response to a connect or disconnect request, on the assigned TCP port. This is only reported for the first execution of a connect or disconnect operation. |
| 7002 | MB_CLIENT is waiting for a Modbus server response to a connect or disconnect request, for the assigned TCP port. This will be reported for any subsequent executions, while waiting for completion of a connect or disconnect operation. |
| 7003 | A disconnect operation has successfully completed (Only valid for one PLC scan). |
| 80C8 | The server did not respond in the assigned time. MB_CLIENT must receive a response using the transaction ID that was originally transmitted within the assigned time or this error is returned. Check the connection to the Modbus server device. This error is only reported after any configured retries (if applicable) have been attempted. |
| 8188 | Invalid mode value |
| 8189 | Invalid data address value |
| 818A | Invalid data length value |
| 818B | Invalid pointer to the DATA_PTR area. This can be the combination of MB_DATA_ADDRESS + MB_DATA_LEN. |
| 818C | Pointer to a optimized DATA_PTR area (must be a standard DB area or M memory area) |
| 8200 | The port is busy processing an existing Modbus request. |
| 8380 | Received Modbus frame is malformed or too few bytes have been received. |

12.5 Modbus communication

| STATUS (W#16#) | MB_CLIENT parameter errors |
|----------------|---|
| 8387 | The assigned Connection ID parameter is different from the ID used for previous requests. There can only be a single Connection ID used within each MB_CLIENT instance DB. This is also used as an internal error if the Modbus TCP protocol ID received from a server is not 0. |
| 8388 | A Modbus server returned a quantity of data that is different than what was requested. This applies to Modbus functions 15 or 16 only. |

¹ In addition to the MB_CLIENT errors listed above, errors can be returned from the underlying T block communication instructions (TCON, TDISCON, TSEND, and TRCV).

See also

TCON, TDISCON, TSEND, and TRCV (TCP communication) instructions (Page 527)

12.5.2.2 MB_SERVER (Communicate via PROFINET as Modbus TCP server) instruction

Table 12- 55 MB_SERVER instruction

| LAD / FBD | SCL | Description |
|-----------|--|---|
| | <pre>"MB_SERVER_DB" (DISCONNECT:=_bool_in_, CONNECT_ID:=_uint_in_, IP_PORT:=_uint_in_, NDR=>_bool_out_, DR=>_bool_out_, ERROR=>_bool_out_, STATUS=>_word_out_, MB_HOLD_REG:=_variant_inout_);</pre> | <p>MB_SERVER communicates as a Modbus TCP server through the PROFINET connector on the S7-1200 CPU. No additional communication hardware module is required.</p> <p>MB_SERVER can accept a request to connect with Modbus TCP client, receive a Modbus function request, and send a response message.</p> |

Table 12- 56 Data types for the parameters

| Parameter and type | Data type | Description |
|--------------------|-----------|--|
| DISCONNECT IN | Bool | MB_SERVER attempts to make a "passive" connection with a partner device. This means that the server is passively listening for a TCP connection request from any requesting IP address. If DISCONNECT = 0 and a connection does not exist, then a passive connection can be initiated. If DISCONNECT = 1 and a connection exists, then a disconnect operation is initiated. This allows your program to control when a connection is accepted. Whenever this input is enabled, no other operation will be attempted. |
| CONNECT_ID IN | UInt | CONNECT_ID uniquely identifies each connection within the PLC. Each unique instance of the MB_CLIENT or MB_SERVER instruction must contain a unique CONNECT_ID parameter. |

| Parameter and type | | Data type | Description |
|--------------------|--------|-----------|---|
| IP_PORT | IN | UInt | Default value = 502: The IP port number that identifies the IP port that will be monitored for a connection request from a Modbus client. These TCP port numbers are not allowed for a MB_SERVER passive connection: 20, 21, 25, 80, 102, 123, 5001, 34962, 34963, and 34964. |
| MB_HOLD_REG | IN_OUT | VARIANT | Pointer to the MB_SERVER Modbus holding register: The holding register must either be a standard global DB or a M memory address. This memory area is used to hold the values a Modbus client is allowed to access using Modbus register functions 3 (read), 6 (write), and 16 (write). |
| NDR | OUT | Bool | New Data Ready: 0 = No new data, 1 = Indicates that new data has been written by a Modbus client |
| DR | OUT | Bool | Data Read: 0 = No data read, 1 = Indicates that data has been read by a Modbus client. |
| ERROR | OUT | Bool | The ERROR bit is TRUE for one scan, after MB_SERVER execution was terminated with an error. The error code value at the STATUS parameter is valid only during the single cycle where ERROR = TRUE. |
| STATUS | OUT | Word | Execution condition code |

MB_SERVER allows incoming Modbus function codes (1, 2, 4, 5, and 15) to read or write bits and words directly in the input process image and output process image of the S7-1200 CPU. For data transfer function codes (3, 6, and 16), the MB_HOLD_REG parameter must be defined as a data type larger than a byte. The following table shows the mapping of Modbus addresses to the process image in the CPU.

Table 12- 57 Mapping of Modbus addresses to the process image

| Modbus functions | | | | | | S7-1200 | |
|------------------|------------|-----------|---------------|----|-------|----------------------|-----------------|
| Codes | Function | Data area | Address range | | | Data area | CPU address |
| 01 | Read bits | Output | 1 | To | 8192 | Output Process Image | Q0.0 to Q1023.7 |
| 02 | Read bits | Input | 10001 | To | 18192 | Input Process Image | I0.0 to I1023.7 |
| 04 | Read words | Input | 30001 | To | 30512 | Input Process Image | IW0 to IW1022 |
| 05 | Write bit | Output | 1 | To | 8192 | Output Process Image | Q0.0 to Q1023.7 |
| 15 | Write bits | Output | 1 | To | 8192 | Output Process Image | Q0.0 to Q1023.7 |

Incoming Modbus message function codes function codes (3, 6, and 16) read or write words in a Modbus holding register which can be an M memory address range or a data block. The type of holding register is specified by the MB_HOLD_REG parameter.

Note

MB_HOLD_REG parameter assignment

The Modbus Holding Register can be in a standard global DB or an M memory address.

For A Modbus holding register in M memory, use the standard Any Pointer format. This is in the format P#"Bit Address" "Data Type" "Length". An example would be P#M1000.0 WORD 500

12.5 Modbus communication

The following table shows examples of Modbus address to holding register mapping used for Modbus function codes 03 (read words), 06 (write word), and 16 (write words). The actual upper limit of DB addresses is determined by the maximum work memory limit and M memory limit, for each CPU model.

Table 12- 58 Mapping examples of Modbus address to CPU memory address

| Modbus Address | MB_HOLD_REG parameter examples | | |
|----------------|--------------------------------|----------------------|------------------------|
| | P#M100.0 Word 5 | P#DB10.DBx0.0 Word 5 | "Recipe".ingredient |
| 40001 | MW100 | DB10.DBW0 | "Recipe".ingredient[1] |
| 40002 | MW102 | DB10.DBW2 | "Recipe".ingredient[2] |
| 40003 | MW104 | DB10.DBW4 | "Recipe".ingredient[3] |
| 40004 | MW106 | DB10.DBW6 | "Recipe".ingredient[4] |
| 40005 | MW108 | DB10.DBW8 | "Recipe".ingredient[5] |

Multiple server connections

Multiple server connections may be created. This permits a single PLC to establish concurrent connections to multiple Modbus TCP clients.

A Modbus TCP server can support concurrent connections up to the maximum number of Open User Communications connections allowed by the PLC. The total number of connections for a PLC, including Modbus TCP Clients and Servers, must not exceed the maximum number of supported Open User Communications connections (Page 511). The Modbus TCP connections may be shared between Client and/or Server type connections.

Individual server connection must follow these rules:

- Each MB_SERVER connection must use a distinct instance DB.
- Each MB_SERVER connection must be established with a unique IP port number. Only 1 connection per port is supported.
- Each MB_SERVER connection must use a unique connection ID.
- The MB_SERVER must be called individually for each connection (with its respective instance DB).

The Connection ID must be unique for each individual connection. This means a single, unique Connection ID must only be used with each individual instance DB. In summary, the instance DB and the Connection ID are paired together and must be unique for every connection.

Table 12- 59 Modbus diagnostic function codes

| MB_SERVER Modbus diagnostic functions | | |
|---------------------------------------|--------------|---|
| Codes | Sub-function | Description |
| 08 | 0x0000 | Return query data echo test: The MB_SERVER will echo back to a Modbus client a word of data that is received. |
| 08 | 0x000A | Clear communication event counter: The MB_SERVER will clear out the communication event counter that is used for Modbus function 11. |
| 11 | | Get communication event counter: The MB_SERVER uses an internal communication event counter for recording the number of successful Modbus read and write requests that are sent to the Modbus server. The counter does not increment on any Function 8 or Function 11 requests. It is also not incremented on any requests that result in a communication error. The broadcast function is not available for Modbus TCP, because only one client-server connection exists at any one time. |

MB_SERVER variables

This table shows the public static variables stored in the MB_SERVER instance data block that can be used in your program

Table 12- 60 MB_SERVER public static variables

| Variable | Data type | Default value | Description |
|----------------------|-----------|---------------|---|
| HR_Start_Offset | Word | 0 | Assigns the starting address of the Modbus Holding register |
| Request_Count | Word | 0 | The number of all requests received by this server. |
| Server_Message_Count | Word | 0 | The number of requests received for this specific server. |
| Xmt_Rcv_Count | Word | 0 | The number of transmissions or receptions that have encountered an error. Also, incremented if a message is received that is an invalid Modbus message. |
| Exception_Count | Word | 0 | Modbus specific errors that require a returned exception |
| Success_Count | Word | 0 | The number of requests received for this specific server that have no protocol errors. |
| Connected | Bool | 0 | Indicates whether the connection to the assigned client is connected or disconnected: 1=connected, 0=disconnected |

Your program can write values to the HR_Start_Offset and control Modbus server operations. The other variables can be read to monitor Modbus status.

HR_Start_Offset

Modbus holding register addresses begin at 40001. These addresses correspond to the beginning PLC memory address of the holding register. However, you can configure the "HR_Start_Offset" variable to start the beginning Modbus holding register address at another value instead of 40001.

For example, if the holding register is configured to start at MW100 and is 100 words long. An offset of 20 specifies a beginning holding register address of 40021 instead of 40001. Any address below 40021 and above 40119 will result in an addressing error.

Table 12- 61 Example of Modbus holding register addressing

| HR_Start_Offset | Address | Minimum | Maximum |
|-----------------|-----------------------|---------|---------|
| 0 | Modbus address (Word) | 40001 | 40099 |
| | S7-1200 address | MW100 | MW298 |
| 20 | Modbus address (Word) | 40021 | 40119 |
| | S7-1200 address | MW100 | MW298 |

HR_Start_Offset is a word value that specifies the starting address of the Modbus holding register and is stored in the MB_SERVER instance data block. You can set this public static variable value by using the parameter helper drop-list, after MB_SERVER is placed in your program.

For example, after MB_SERVER is placed in a LAD network, you can go to a previous network and assign the HR_Start_Offset value. The value must be assigned prior to execution of MB_SERVER.

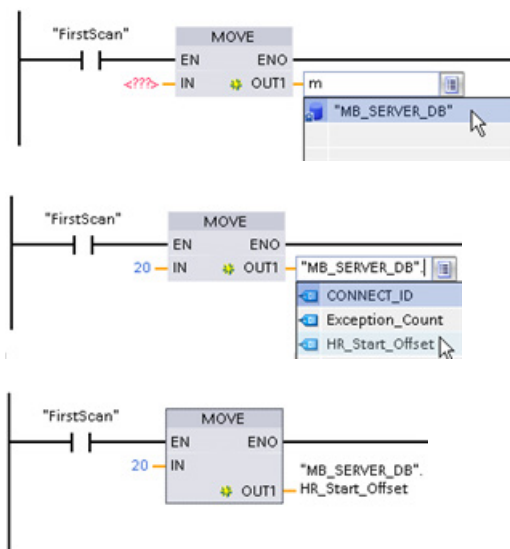

Entering a Modbus server variable using the default DB name:

1. Set the cursor in the parameter field and type an m character.
2. Select "MB_SERVER_DB" from the drop-list of DB names.
3. Select "MB_SERVER_DB.HR_Start_Offset" from the drop-list of DB variables.

Table 12- 62 MB_SERVER execution condition codes ¹

| STATUS (W#16#) | Response code to Modbus server (B#16#) | Modbus protocol errors |
|----------------|--|---|
| 7001 | | MB_SERVER is waiting for a Modbus client to connect to the assigned TCP port. This code is reported on the first execution of a connect or disconnect operation. |
| 7002 | | MB_SERVER is waiting for a Modbus client to connect to the assigned TCP port. This code is reported for any subsequent executions, while waiting for completion of a connect or disconnect operation. |
| 7003 | | A disconnect operation has successfully completed (Only valid for one PLC scan). |
| 8187 | | Invalid pointer to MB_HOLD_REG: area is too small |
| 818C | | Pointer to an optimized MB_HOLD_REG area (must be a standard DB area or M memory area) or Blocked process timeout exceeds the limit of 55 seconds. (S7-1200 specific) |
| 8381 | 01 | Function code not supported |
| 8382 | 03 | Data length error |
| 8383 | 02 | Data address error or access outside the bounds of the MB_HOLD_REG address area |
| 8384 | 03 | Data value error |
| 8385 | 03 | Data diagnostic code value not supported (function code 08) |

¹ In addition to the MB_SERVER errors listed above, errors can be returned from the underlying T block communication instructions (TCON, TDISCON, TSEND, and TRCV).

See also

TCON, TDISCON, TSEND, and TRCV (TCP communication) instructions (Page 527)

12.5.2.3 MB_SERVER example: Multiple TCP connections

You can have multiple Modbus TCP server connections. To accomplish this, MB_SERVER must be independently executed for each connection. Each connection must use an independent instance DB, connection ID, and IP port. The S7-1200 allows only one connection per IP port.

For best performance, MB_SERVER should be executed every program cycle, for each connection.

Network 1: Connection #1 with independent IP_PORT, connection ID, and instance DB

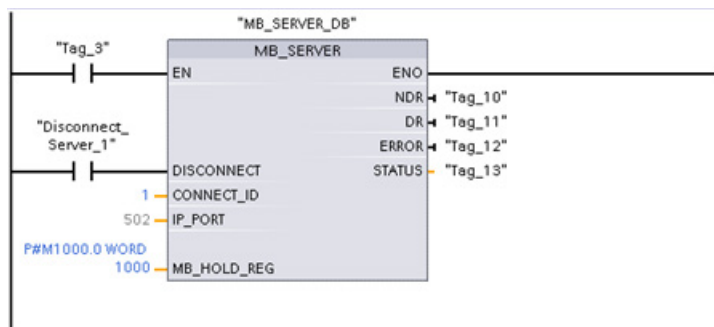

Network 2: Connection #2 with independent IP_PORT, connection ID, and instance DB

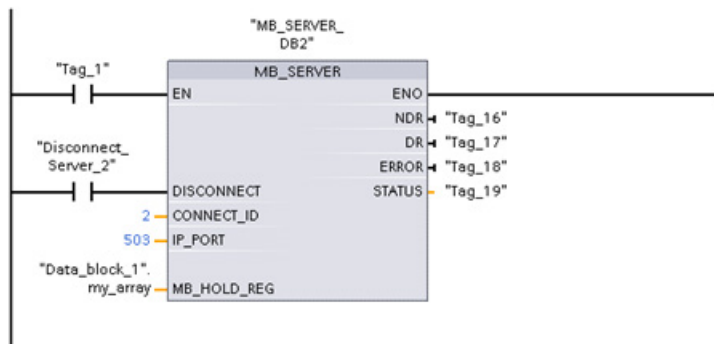

12.5.2.4 MB_CLIENT example 1: Multiple requests with common TCP connection

Multiple Modbus client requests can be sent over the same connection. To accomplish this, use the same instance DB, connection ID, and port number.

Only 1 client can be active at any given time. Once a client completes its execution, the next client begins execution. Your program is responsible for the order of execution.

The example shows both clients writing to the same memory area. Also, a returned error is captured which is optional.

Network 1: Modbus function 1 - Read 16 output image bits

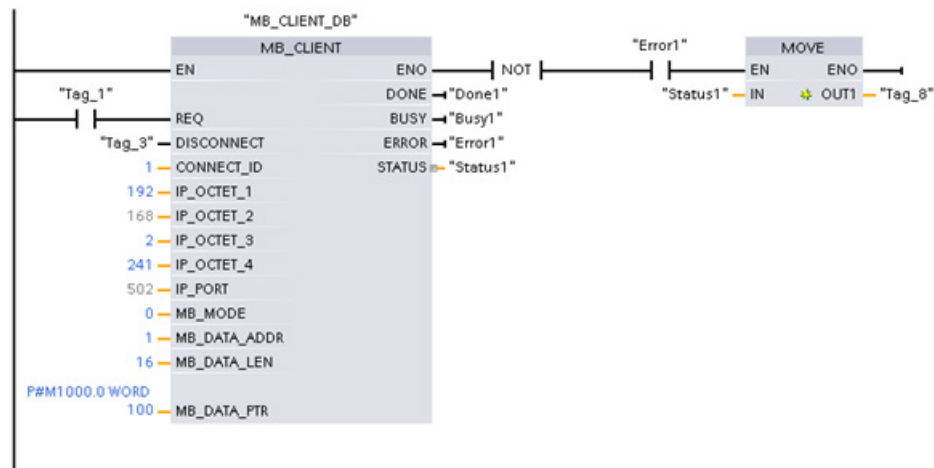

Network 2: Modbus function 2 - Read 32 input image bits

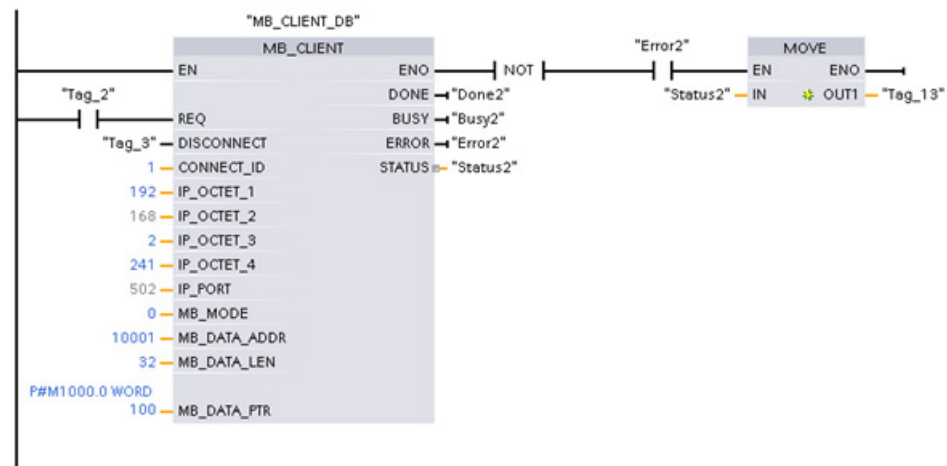

12.5.2.5 MB_CLIENT example 2: Multiple requests with different TCP connections

Modbus client requests can be sent over different connections. To accomplish this, different instance DBs, IP addresses, and connection IDs must be used.

The port number must be different if the connections are established to the same Modbus server. If the connections are on different servers, there is no port number restriction.

The example shows both clients writing to the same memory area. Also, a returned error is captured which is optional.

Network 1:

Modbus function 4 - Read input words (in S7-1200 memory)

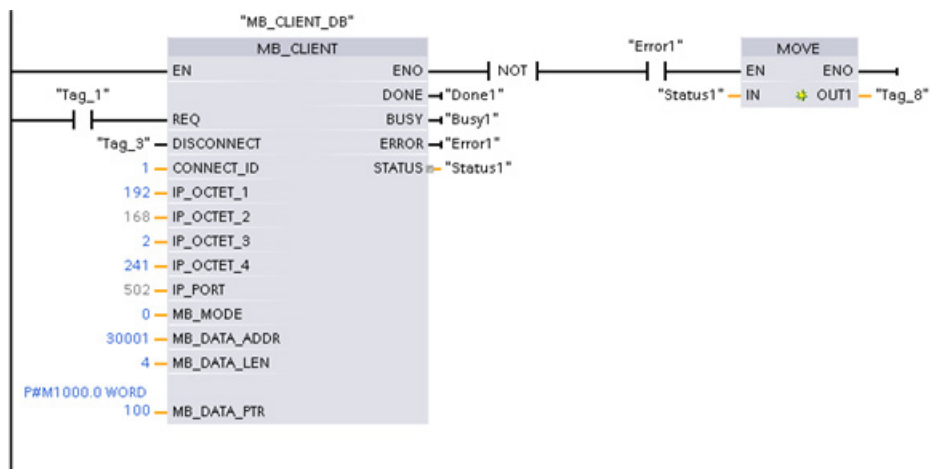

Network 2: Modbus function 3 - Read holding register words from a Modbus TCP server

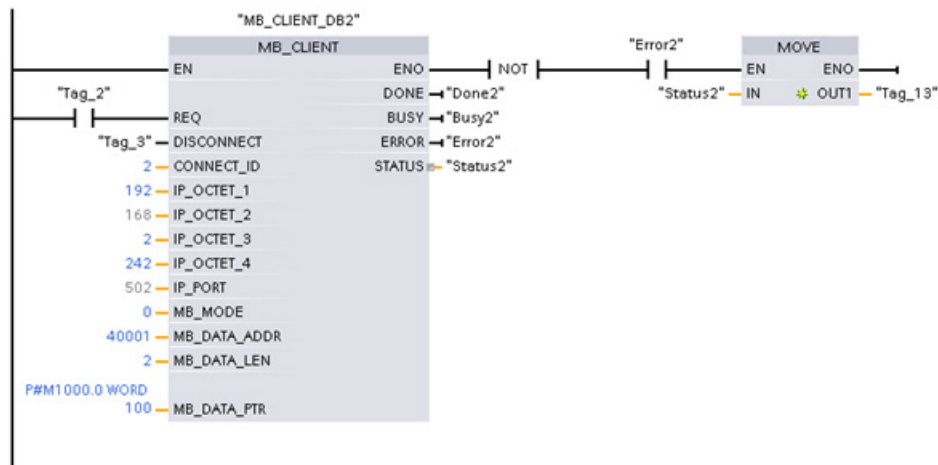

12.5.2.6 MB_CLIENT example 3: Output image write request

This example shows a Modbus client request to write the S7-1200 output image.

Network 1: Modbus function 15 - Write S7-1200 output image bits

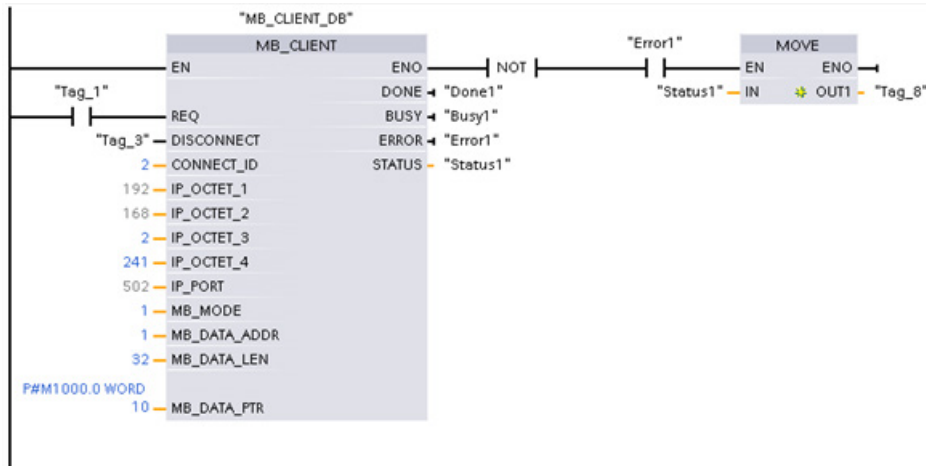

12.5.2.7 MB_CLIENT example 4: Coordinating multiple requests

You must ensure that each individual Modbus TCP request finishes execution. This coordination must be provided by your program. The example below shows how the outputs of the first and second client requests can be used to coordinate execution.

The example shows both clients writing to the same memory area. Also, a returned error is captured which is optional.

Network 1: Modbus function 3 - Read holding register words

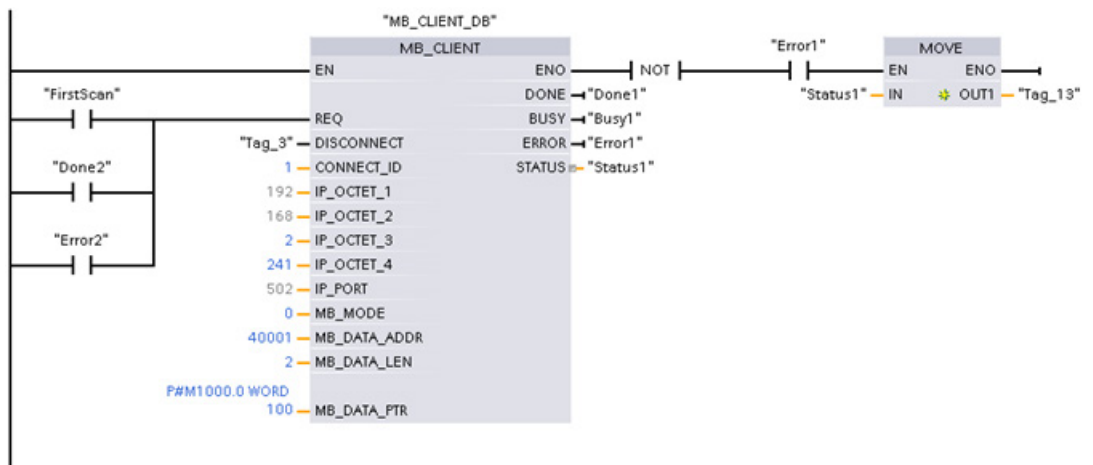

Network 2: Modbus function 3 - Read holding register words

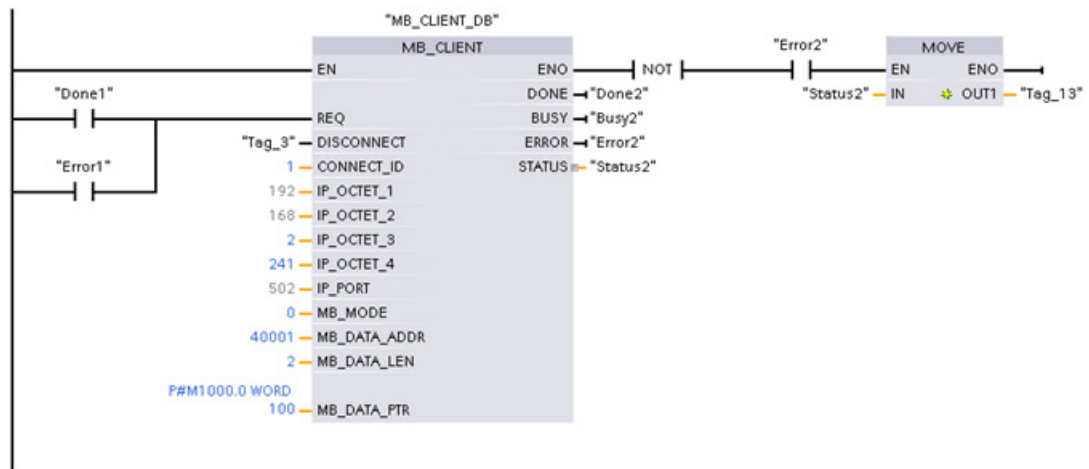

12.5.3 Modbus RTU

There are two versions of the Modbus RTU instructions available in STEP 7:

- Version 1 was initially available in STEP 7 Basic V10.5.
- Version 2 is available in STEP 7 Basic/Professional V11. The version 2 design adds REQ and DONE parameters to MB_COMM_LOAD. Also, the MB_ADDR parameter for MB_MASTER and MB_SLAVE now allows a UInt value for extended addressing.

For compatibility and ease of migration, you can choose which instruction version to insert into your user program.

Do not use both 1.x and 2.y instruction versions in the same CPU program. Your program's Modbus instructions must have the same major version number (1.x, 2.y, or V.z). The individual instructions within a major version group may have different minor versions (1.x).



Click the icon on the instruction tree task card to enable the headers and columns of the instruction tree.

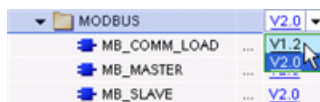

To change the version of the Modbus instructions, select the version from the drop-down list. You can select the group or individual instructions.

When you use the instruction tree to place a Modbus instruction in your program, a new FB instance is created in the project tree. You can see new FB instance in the project tree under PLC_x > Program blocks > System blocks > Program resources.

To verify the version of a Modbus instruction in a program, you must inspect project tree properties and not the properties of a box displayed in the program editor. Select a project tree Modbus FB instance, right-click, select "Properties", and select the "Information" page to see the Modbus instruction version number.

12.5.3.1 MB_COMM_LOAD (Configure port on the PtP module for Modbus RTU) instruction

Table 12- 63 MB_COMM_LOAD instruction

| LAD / FBD | SCL | Description |
|-----------|---|--|
| | <pre>"MB_COMM_LOAD_DB" (REQ:=_bool_in_, PORT:=_uint_in_, BAUD:=_udint_in_, PARITY:=_uint_in_, FLOW_CTRL:=_uint_in_, RTS_ON_DLY:=_uint_in_, RTS_OFF_DLY:=_uint_in_, RESP_TO:=_uint_in_, DONE=>_bool_out_, ERROR=>_bool_out_, STATUS=>_word_out_, MB_DB:=_fbtref_inout_);</pre> | <p>The MB_COMM_LOAD instruction configures a PtP port for Modbus RTU protocol communications. Modbus port hardware options: Install up to three CMs (RS485 or RS232), plus one CB (R4845). An instance data block is assigned automatically when you place the MB_COMM_LOAD instruction in your program.</p> |

Table 12- 64 Data types for the parameters

| Parameter and type | Data type | Description |
|---------------------------|-----------|--|
| REQ IN | Bool | A low to high (positive edge) signal starts the operation. (Version 2.0 only) |
| PORT IN | Port | After you install and configure a CM or CB communication device, the port identifier appears in the parameter helper drop-list available at the PORT box connection. The assigned CM or CB port value is the device configuration property "hardware identifier". The port symbolic name is assigned in the "System constants" tab of the PLC tag table. |
| BAUD IN | UDInt | Baud rate selection: 300, 600, 1200, 2400, 4800, 9600, 19200, 38400, 57600, 76800, 115200, all other values are invalid |
| PARITY IN | UInt | Parity selection: <ul style="list-style-type: none"> • 0 – None • 1 – Odd • 2 – Even |
| FLOW_CTRL ¹ IN | UInt | Flow control selection: <ul style="list-style-type: none"> • 0 – (default) no flow control • 1 – Hardware flow control with RTS always ON (does not apply to RS485 ports) • 2 – Hardware flow control with RTS switched |

12.5 Modbus communication

| Parameter and type | Data type | Description |
|--------------------------|-----------|--|
| RTS_ON_DLY ¹ | IN | UInt RTS ON delay selection: <ul style="list-style-type: none"> 0 – (default) No delay from RTS active until the first character of the message is transmitted 1 to 65535 – Delay in milliseconds from RTS active until the first character of the message is transmitted (does not apply to RS485 ports). RTS delays shall be applied independent of the FLOW_CTRL selection. |
| RTS_OFF_DLY ¹ | IN | UInt RTS OFF delay selection: <ul style="list-style-type: none"> 0 – (default) No delay from the last character transmitted until RTS goes inactive 1 to 65535 – Delay in milliseconds from the last character transmitted until RTS goes inactive (does not apply to RS485 ports). RTS delays shall be applied independent of the FLOW_CTRL selection. |
| RESP_TO ¹ | IN | UInt Response timeout: Time in milliseconds allowed by MB_MASTER for the slave to respond. If the slave does not respond in this time period, MB_MASTER will retry the request or terminate the request with an error when the specified number of retries has been sent. 5 ms to 65535 ms (default value = 1000 ms). |
| MB_DB | IN | Variant A reference to the instance data block used by the MB_MASTER or MB_SLAVE instructions. After MB_SLAVE or MB_MASTER is placed in your program, the DB identifier appears in the parameter helper drop-list available at the MB_DB box connection. |
| DONE | OUT | Bool The DONE bit is TRUE for one scan, after the last request was completed with no error. (Version 2.0 only) |
| ERROR | OUT | Bool The ERROR bit is TRUE for one scan, after the last request was terminated with an error. The error code value at the STATUS parameter is valid only during the single scan where ERROR = TRUE. |
| STATUS | OUT | Word Execution condition code |

¹ Optional parameters for MB_COMM_LOAD (V 2.x or later). Click the arrow at the bottom of a LAD/FBD box to expand the box and include these parameters.

MB_COMM_LOAD is executed to configure a port for the Modbus RTU protocol. Once a port is configured for the Modbus RTU protocol, it can only be used by either the MB_MASTER or MB_SLAVE instructions.

One execution of MB_COMM_LOAD must be used to configure each communication port that is used for Modbus communication. Assign a unique MB_COMM_LOAD instance DB for each port that you use. You can install up to three communication modules (RS232 or RS485) and one communication board (RS485) in the CPU. Call MB_COMM_LOAD from a startup OB and execute it one time or use the first scan system flag (Page 101) to initiate the call to execute it one time. Only execute MB_COMM_LOAD again if communication parameters like baud rate or parity must change.

An instance data block is assigned for MB_MASTER or MB_SLAVE when you place these instructions in your program. This instance data block is referenced when you specify the MB_DB parameter for the MB_COMM_LOAD instruction.

MB_COMM_LOAD data block variables

The following table shows the public static variables stored in the instance DB for the MB_COMM_LOAD that can be used in your program.

Table 12- 65 Static variables in the instance DB

| Variable | Data type | Description |
|-----------|-----------|---|
| ICHAR_GAP | UInt | Delay for Inter-character gap between characters. This parameter is specified in milliseconds and is used to increase the expected amount of time between received characters. The corresponding number of bit times for this parameter is added to the Modbus default of 35 bit times (3.5 character times). |
| RETRIES | UInt | Number of retries that the master will attempt before returning the no response error code 0x80C8. |
| STOP_BITS | USInt | Number of stop bits used in framing each character. Valid values are 1 and 2. |

Table 12- 66 MB_COMM_LOAD execution condition codes ¹

| STATUS (W#16#) | Description |
|----------------|---|
| 0000 | No error |
| 8180 | Invalid port ID value (wrong port/hardware identifier for communication module) |
| 8181 | Invalid baud rate value |
| 8182 | Invalid parity value |
| 8183 | Invalid flow control value |
| 8184 | Invalid response timeout value (response timeout less than the 5 ms minimum) |
| 8185 | MB_DB parameter is not an instance data block of a MB_MASTER or MB_SLAVE instruction. |

¹ In addition to the MB_COMM_LOAD errors listed above, errors can be returned from the underlying PtP communication instructions.

12.5.3.2 MB_MASTER (Communicate via the PtP port as Modbus master) instruction

Table 12- 67 MB_MASTER instruction

| LAD / FBD | SCL | Description |
|-----------|--|---|
| | <pre>"MB_MASTER_DB" (REQ:=_bool_in_, MB_ADDR:=_uint_in_, MODE:=_usint_in_, DATA_ADDR:=_udint_in_, DATA_LEN:=_uint_in_, DONE=>_bool_out_, BUSY=>_bool_out_, ERROR=>_bool_out_, STATUS=>_word_out_, DATA_PTR:=_variant_inout_);</pre> | <p>The MB_MASTER instruction communicates as a Modbus master using a port that was configured by a previous execution of the MB_COMM_LOAD instruction. An instance data block is assigned automatically when you place the MB_MASTER instruction in your program. This MB_MASTER instance data block is used when you specify the MB_DB parameter for the MB_COMM_LOAD instruction.</p> |

12.5 Modbus communication

Table 12- 68 Data types for the parameters

| Parameter and type | | Data type | Description |
|--------------------|-----|---------------------------|---|
| REQ | IN | Bool | 0=No request 1= Request to transmit data to Modbus slave |
| MB_ADDR | IN | V1.0: USInt V2.0: UInt | Modbus RTU station address: Standard addressing range (1 to 247) Extended addressing range (1 to 65535) The value of 0 is reserved for broadcasting a message to all Modbus slaves. Modbus function codes 05, 06, 15 and 16 are the only function codes supported for broadcast. |
| MODE | IN | USInt | Mode Selection: Specifies the type of request (read, write, or diagnostic). See the Modbus functions table below for details. |
| DATA_ADDR | IN | UDInt | Starting Address in the slave: Specifies the starting address of the data to be accessed in the Modbus slave. See the Modbus functions table below for valid addresses. |
| DATA_LEN | IN | UInt | Data Length: Specifies the number of bits or words to be accessed in this request. See the Modbus functions table below for valid lengths. |
| DATA_PTR | IN | Variant | Data Pointer: Points to the M or DB address (Standard DB type) for the data being written or read. |
| DONE | OUT | Bool | The DONE bit is TRUE for one scan, after the last request was completed with no error. |
| BUSY | OUT | Bool | <ul style="list-style-type: none"> • 0 – No MB_MASTER operation in progress • 1 – MB_MASTER operation in progress |
| ERROR | OUT | Bool | The ERROR bit is TRUE for one scan, after the last request was terminated with an error. The error code value at the STATUS parameter is valid only during the single scan where ERROR = TRUE. |
| STATUS | OUT | Word | Execution condition code |

Modbus master communication rules

- MB_COMM_LOAD must be executed to configure a port before a MB_MASTER instruction can communicate with that port.
- If a port is to be used to initiate Modbus master requests, that port should not be used by MB_SLAVE. One or more instances of MB_MASTER execution can be used with that port, but all MB_MASTER execution must use the same MB_MASTER instance DB for that port.
- The Modbus instructions do not use communication interrupt events to control the communication process. Your program must poll the MB_MASTER instruction for transmit and receive complete conditions.
- It is recommended that you call all MB_MASTER execution for a given port from a program cycle OB. Modbus master instructions may execute in only one of the program cycle or cyclic/time delay execution levels. They must not execute in both execution priority levels. Pre-emption of a Modbus Master instruction by another Modbus master instruction in a higher priority execution priority level will result in improper operation. Modbus master instructions must not execute in the startup, diagnostic or time error execution priority levels.
- Once a master instruction initiates a transmission, this instance must be continually executed with the EN input enabled until a DONE=1 state or ERROR=1 state is returned. A particular MB_MASTER instance is considered active until one of these two events occurs. While the original instance is active, any call to any other instance with the REQ input enabled will result in an error. If the continuous execution of the original instance stops, the request state remains active for a period of time specified by the static variable Blocked_Proc_Timeout. Once this period of time expires, the next master instruction called with an enabled REQ input will become the active instance. This prevents a single Modbus master instance from monopolizing or locking access to a port. If the original active instance is not enabled within the period of time specified by the static variable "Blocked_Proc_Timeout", then the next execution by this instance (with REQ not set) will clear the active state. If (REQ is set), then this execution initiates a new master request as if no other instance was active.

REQ parameter

0 = No request; 1 = Request to transmit data to Modbus Slave

You may control this input either through the use of a level or edge triggered contact. Whenever this input is enabled, a state machine is started to ensure that no other MB_MASTER using the same instance DB is allowed to issue a request, until the current request is completed. All other input states are captured and held internally for the current request, until the response is received or an error detected.

If the same instance of MB_MASTER is executed again with REQ input = 1 before the completion of the current request, then no subsequent transmissions are made. However, when the request is completed, a new request is issued whenever MB_MASTER is executed again with REQ input = 1.

DATA_ADDR and MODE parameters select the Modbus function type

DATA_ADDR (starting Modbus address in the slave): Specifies the starting address of the data to be accessed in the Modbus slave.

The MB_MASTER instruction uses a MODE input rather than a Function Code input. The combination of MODE and Modbus address determine the Function Code that is used in the actual Modbus message. The following table shows the correspondence between parameter MODE, Modbus function code, and Modbus address range.

Table 12- 69 Modbus functions

| MODE | Modbus Function | Data length | Operation and data | Modbus Address |
|------|-----------------|-------------------------------------|---|---------------------------------------|
| 0 | 01 | 1 to 2000 1 to 1992 ¹ | Read output bits: 1 to (1992 or 2000) bits per request | 1 to 9999 |
| 0 | 02 | 1 to 2000 1 to 1992 ¹ | Read input bits: 1 to (1992 or 2000) bits per request | 10001 to 19999 |
| 0 | 03 | 1 to 125 1 to 124 ¹ | Read Holding registers: 1 to (124 or 125) words per request | 40001 to 49999 or 400001 to 465535 |
| 0 | 04 | 1 to 125 1 to 124 ¹ | Read input words: 1 to (124 or 125) words per request | 30001 to 39999 |
| 1 | 05 | 1 | Write one output bit: One bit per request | 1 to 9999 |
| 1 | 06 | 1 | Write one holding register: 1 word per request | 40001 to 49999 or 400001 to 465535 |
| 1 | 15 | 2 to 1968 2 to 1960 ¹ | Write multiple output bits: 2 to (1960 or 1968) bits per request | 1 to 9999 |
| 1 | 16 | 2 to 123 2 to 122 ¹ | Write multiple holding registers: 2 to (122 or 123) words per request | 40001 to 49999 or 400001 to 465535 |
| 2 | 15 | 1 to 1968 2 to 1960 ¹ | Write one or more output bits: 1 to (1960 or 1968) bits per request | 1 to 9999 |
| 2 | 16 | 1 to 123 1 to 122 ¹ | Write one or more holding registers: 1 to (122 or 123) words per request | 40001 to 49999 or 400001 to 465535 |
| 11 | 11 | 0 | Read the slave communication status word and event counter. The status word indicates busy (0 – not busy, 0xFFFF - busy). The event counter is incremented for each successful completion of a message. Both the DATA_ADDR and DATA_LEN operands of MB_MASTER are ignored for this function. | |
| 80 | 08 | 1 | Check slave status using data diagnostic code 0x0000 (Loopback test – slave echoes the request) 1 word per request | |

| MODE | Modbus Function | Data length | Operation and data | Modbus Address |
|------------------------------------|-----------------|-------------|--|----------------|
| 81 | 08 | 1 | Reset slave event counter using data diagnostic code 0x000A 1 word per request | |
| 3 to 10, 12 to 79, 82 to 255 | | | Reserved | |

¹ For "Extended Addressing" mode the maximum data lengths are reduced by 1 byte or 1 word depending upon the data type used by the function.

DATA_PTR parameter

The DATA_PTR parameter points to the DB or M address that is written to or read from. If you use a data block, then you must create a global data block that provides data storage for reads and writes to Modbus slaves.

Note

The DATA_PTR data block type must allow direct addressing

The data block must allow both direct (absolute) and symbolic addressing. When you create the data block the "Standard" access attribute must be selected.

Data block structures for the DATA_PTR parameter

- These data types are valid for **word reads** of Modbus addresses 30001 to 39999, 40001 to 49999, and 400001 to 465536 and also for **word writes** to Modbus addresses 40001 to 49999 and 400001 to 465536.
 - Standard array of WORD, UINT, or INT data types
 - Named WORD, UINT, or INT structure where each element has a unique name and 16 bit data type.
 - Named complex structure where each element has a unique name and a 16 or 32 bit data type.
- For **bit reads** and writes of Modbus addresses 00001 to 09999 and bit reads of 10001 to 19999.
 - Standard array of Boolean data types.
 - Named Boolean structure of uniquely named Boolean variables.
- Although not required, it is recommended that each MB_MASTER instruction have its own separate memory area. The reason for this recommendation is that there is a greater possibility of data corruption if multiple MB_MASTER instructions are reading and writing to the same memory area.
- There is no requirement that the DATA_PTR data areas be in the same global data block. You can create one data block with multiple areas for Modbus reads, one data block for Modbus writes, or one data block for each slave station.

Modbus master data block variables

The following table shows the public static variables stored in the instance DB for MB_MASTER that can be used in your program.

Table 12- 70 Static variables in the instance DB

| Variable | Data type | Initial value | Description |
|----------------------|-----------|---------------|---|
| Blocked_Proc_Timeout | Real | 3.0 | Amount of time (in seconds) to wait for a blocked Modbus Master instance before removing this instance as being ACTIVE. This can occur, for example, when a Master request has been issued and then the program stops calling the Master function before it has completely finished the request. The time value must be greater than 0 and less than 55 seconds, or an error occurs. The default value is .5 seconds. |
| Extended_Addressing | Bool | False | Configures single or double-byte slave addressing. The default value = 0. (0=single byte address, 1=double-byte address) |

Your program can write values to the Blocked_Proc_Timeout and Extended_Addressing variables to control Modbus master operations. See the MB_SLAVE topic description of HR_Start_Offset and Extended_Addressing for an example of how to use these variables in the program editor and details about Modbus extended addressing (Page 755).

Condition codes

Table 12- 71 MB_MASTER execution condition codes (communication and configuration errors) ¹

| STATUS (W#16#) | Description |
|----------------|---|
| 0000 | No error |
| 80C8 | Slave timeout. Check baud rate, parity, and wiring of slave. |
| 80D1 | The receiver issued a flow control request to suspend an active transmission and never re-enabled the transmission during the specified wait time. This error is also generated during hardware flow control when the receiver does not assert CTS within the specified wait time. |
| 80D2 | The transmit request was aborted because no DSR signal is received from the DCE. |
| 80E0 | The message was terminated because the receive buffer is full. |
| 80E1 | The message was terminated as a result of a parity error. |
| 80E2 | The message was terminated as a result of a framing error. |
| 80E3 | The message was terminated as a result of an overrun error. |
| 80E4 | The message was terminated as a result of the specified length exceeding the total buffer size. |
| 8180 | Invalid port ID value or error with MB_COMM_LOAD instruction |
| 8186 | Invalid Modbus station address |
| 8188 | Invalid Mode specified for broadcast request |
| 8189 | Invalid Data Address value |
| 818A | Invalid Data Length value |
| 818B | Invalid pointer to the local data source/destination: Size not correct |
| 818C | Invalid pointer for DATA_PTR or invalid Blocked_Proc_Timeout: The data area must be a DB (that allows both symbolic and direct access) or M memory. |
| 8200 | Port is busy processing a transmit request. |

Table 12- 72 MB_MASTER execution condition codes (Modbus protocol errors) ¹

| STATUS (W#16#) | Response code from slave | Modbus protocol errors |
|----------------|--------------------------|---|
| 8380 | - | CRC error |
| 8381 | 01 | Function code not supported |
| 8382 | 03 | Data length error |
| 8383 | 02 | Data address error or address outside the valid range of the DATA_PTR area |
| 8384 | Greater than 03 | Data value error |
| 8385 | 03 | Data diagnostic code value not supported (function code 08) |
| 8386 | - | Function code in the response does not match the code in the request. |
| 8387 | - | Wrong slave responded |
| 8388 | - | The slave response to a write request is incorrect. The write request returned by the slave does not match what the master actually sent. |

¹ In addition to the MB_MASTER errors listed above, errors can be returned from the underlying PtP communication instructions.

12.5.3.3 MB_SLAVE (Communicate via the PtP port as Modbus slave) instruction

Table 12- 73 MB_SLAVE instruction

| LAD / FBD | SCL | Description |
|---|---|---|
|  | <pre>"MB_SLAVE_DB" (MB_ADDR:=_uint_in_, NDR=>_bool_out_, DR=>_bool_out_, ERROR=>_bool_out_, STATUS=>_word_out_, MB_HOLD_REG:=_variant_inout_);</pre> | <p>The MB_SLAVE instruction allows your program to communicate as a Modbus slave through a PtP port on the CM (RS485 or RS232) and CB (RS485). When a remote Modbus RTU master issues a request, your user program responds to the request by MB_SLAVE execution. STEP 7 automatically creates an instance DB when you insert the instruction. Use this MB_SLAVE_DB name when you specify the MB_DB parameter for the MB_COMM_LOAD instruction.</p> |

Table 12- 74 Data types for the parameters

| Parameter and type | Data type | Description |
|--------------------|-----------|---|
| MB_ADDR | IN | V1.0: USInt V2.0: UInt |
| MB_HOLD_REG | IN | Variant |
| | | Pointer to the Modbus Holding Register DB: The Modbus holding register can be M memory or a data block. |

12.5 Modbus communication

| Parameter and type | | Data type | Description |
|--------------------|-----|-----------|---|
| NDR | OUT | Bool | New Data Ready: <ul style="list-style-type: none"> • 0 – No new data • 1 – Indicates that new data has been written by the Modbus master |
| DR | OUT | Bool | Data Read: <ul style="list-style-type: none"> • 0 – No data read • 1 – Indicates that data has been read by the Modbus master |
| ERROR | OUT | Bool | The ERROR bit is TRUE for one scan, after the last request was terminated with an error. If execution is terminated with an error, then the error code value at the STATUS parameter is valid only during the single scan where ERROR = TRUE. |
| STATUS | OUT | Word | Execution error code |

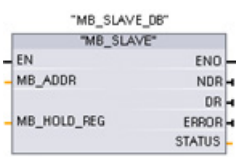
Modbus communication function codes (1, 2, 4, 5, and 15) can read and write bits and words directly in the input process image and output process image of the CPU. For these function codes, the MB_HOLD_REG parameter must be defined as a data type larger than a byte. The following table shows the example mapping of Modbus addresses to the process image in the CPU.

Table 12- 75 Mapping of Modbus addresses to the process image

| Modbus functions | | | | | | S7-1200 | |
|------------------|------------|-----------|---------------|----|-------|----------------------|-----------------|
| Codes | Function | Data area | Address range | | | Data area | CPU address |
| 01 | Read bits | Output | 1 | to | 8192 | Output Process Image | Q0.0 to Q1023.7 |
| 02 | Read bits | Input | 10001 | to | 18192 | Input Process Image | I0.0 to I1023.7 |
| 04 | Read words | Input | 30001 | to | 30512 | Input Process Image | IW0 to IW1022 |
| 05 | Write bit | Output | 1 | to | 8192 | Output Process Image | Q0.0 to Q1023.7 |
| 15 | Write bits | Output | 1 | to | 8192 | Output Process Image | Q0.0 to Q1023.7 |

Modbus communication function codes (3, 6, 16) use a Modbus holding register which can be an M memory address range or a data block. The type of holding register is specified by the MB_HOLD_REG parameter on the MB_SLAVE instruction.

Note

MB_HOLD_REG data block type

A Modbus holding register data block must allow both direct (absolute) and symbolic addressing. When you create the data block the "Standard" access attribute must be selected.

The following table shows examples of Modbus address to holding register mapping that is used for Modbus function codes 03 (read words), 06 (write word), and 16 (write words). The actual upper limit of DB addresses is determined by the maximum work memory limit and M memory limit, for each CPU model.

Table 12- 76 Mapping of Modbus addresses to CPU memory

| Modbus Master Address | MB_HOLD_REG parameter examples | | | | |
|-----------------------|--------------------------------|-----------|-------|------------|------------------------|
| | MW100 | DB10.DBW0 | MW120 | DB10.DBW50 | "Recipe".ingredient |
| 40001 | MW100 | DB10.DBW0 | MW120 | DB10.DBW50 | "Recipe".ingredient[1] |
| 40002 | MW102 | DB10.DBW2 | MW122 | DB10.DBW52 | "Recipe".ingredient[2] |
| 40003 | MW104 | DB10.DBW4 | MW124 | DB10.DBW54 | "Recipe".ingredient[3] |
| 40004 | MW106 | DB10.DBW6 | MW126 | DB10.DBW56 | "Recipe".ingredient[4] |
| 40005 | MW108 | DB10.DBW8 | MW128 | DB10.DBW58 | "Recipe".ingredient[5] |

Table 12- 77 Diagnostic functions

| S7-1200 MB_SLAVE Modbus diagnostic functions | | |
|--|--------------|--|
| Codes | Sub-function | Description |
| 08 | 0000H | Return query data echo test: The MB_SLAVE will echo back to a Modbus master a word of data that is received. |
| 08 | 000AH | Clear communication event counter: The MB_SLAVE will clear out the communication event counter that is used for Modbus function 11. |
| 11 | | Get communication event counter: The MB_SLAVE uses an internal communication event counter for recording the number of successful Modbus read and write requests that are sent to the Modbus slave. The counter does not increment on any Function 8, Function 11, or broadcast requests. It is also not incremented on any requests that result in a communication error (for example, parity or CRC errors). |

The MB_SLAVE instruction supports broadcast write requests from any Modbus master as long as the request is for accessing valid addresses. MB_SLAVE will produce error code 0x8188 for function codes not supported in broadcast.

Modbus slave communication rules

- MB_COMM_LOAD must be executed to configure a port, before a MB_SLAVE instruction can communicate through that port.
- If a port is to respond as a slave to a Modbus master, then do not program that port with the MB_MASTER instruction.
- Only one instance of MB_SLAVE can be used with a given port, otherwise erratic behavior may occur.
- The Modbus instructions do not use communication interrupt events to control the communication process. Your program must control the communication process by polling the MB_SLAVE instruction for transmit and receive complete conditions.
- The MB_SLAVE instruction must execute periodically at a rate that allows it to make a timely response to incoming requests from a Modbus master. It is recommended that you execute MB_SLAVE every scan from a program cycle OB. Executing MB_SLAVE from a cyclic interrupt OB is possible, but is not recommended because of the potential for excessive time delays in the interrupt routine to temporarily block the execution of other interrupt routines.

Modbus signal timing

MB_SLAVE must be executed periodically to receive each request from the Modbus master and then respond as required. The frequency of execution for MB_SLAVE is dependent upon the response timeout period of the Modbus master. This is illustrated in the following diagram.

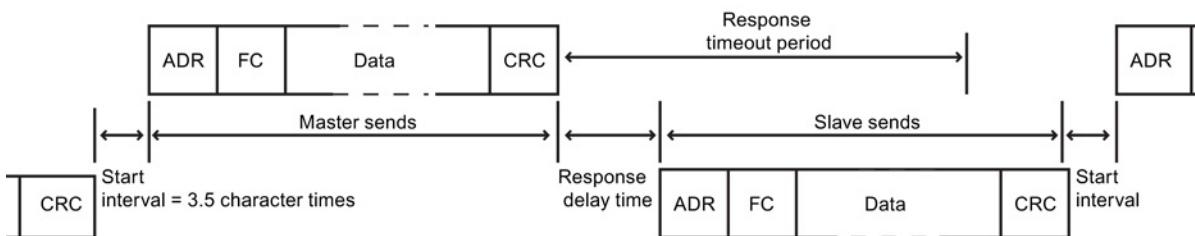

The response timeout period RESP_TO is the amount of time a Modbus master waits for the start of a response from a Modbus slave. This time period is not defined by the Modbus protocol, but is a parameter of each Modbus master. The frequency of execution (the time between one execution and the next execution) of MB_SLAVE must be based on the particular parameters of your Modbus master. At a minimum, you should execute MB_SLAVE twice within the response timeout period of the Modbus master.

Modbus slave variables

This table shows the public static variables stored in the MB_SLAVE instance data block that can be used in your program

Table 12- 78 Modbus slave variables

| Variable | Data type | Description |
|---------------------|-----------|--|
| Request_Count | Word | The number of all requests received by this slave |
| Slave_Message_Count | Word | The number of requests received for this specific slave |
| Bad_CRC_Count | Word | The number of requests received that have a CRC error |
| Broadcast_Count | Word | The number of broadcast requests received |
| Exception_Count | Word | Modbus specific errors that require a returned exception |
| Success_Count | Word | The number of requests received for this specific slave that have no protocol errors |
| HR_Start_Offset | Word | Specifies the starting address of the Modbus Holding register (default = 0) |
| Extended_Addressing | Bool | Configures single or double-byte slave addressing (0=single byte address, 1=double-byte address, default = 0) |

Your program can write values to the HR_Start_Offset and Extended_Addressing variables and control Modbus slave operations. The other variables can be read to monitor Modbus status.

HR_Start_Offset

Modbus holding register addresses begin at 40001 or 400001. These addresses correspond to the beginning PLC memory address of the holding register. However, you can configure the "HR_Start_Offset" variable to start the beginning Modbus holding register address at another value instead of 40001 or 400001.

For example, if the holding register is configured to start at MW100 and is 100 words long. An offset of 20 specifies a beginning holding register address of 40021 instead of 40001. Any address below 40021 and above 400119 will result in an addressing error.

Table 12- 79 Example of Modbus holding register addressing

| HR_Start_Offset | Address | Minimum | Maximum |
|-----------------|-----------------------|---------|---------|
| 0 | Modbus address (Word) | 40001 | 40099 |
| | S7-1200 address | MW100 | MW298 |
| 20 | Modbus address (Word) | 40021 | 40119 |
| | S7-1200 address | MW100 | MW298 |

HR_Start_Offset is a word value that specifies the starting address of the Modbus holding register and is stored in the MB_SLAVE instance data block. You can set this public static variable value by using the parameter helper drop-list, after MB_SLAVE is placed in your program.

12.5 Modbus communication

For example, after MB_SLAVE is placed in a LAD network, you can go to a previous network and assign the HR_Start_Offset value. The value must be assigned prior to execution of MB_SLAVE.

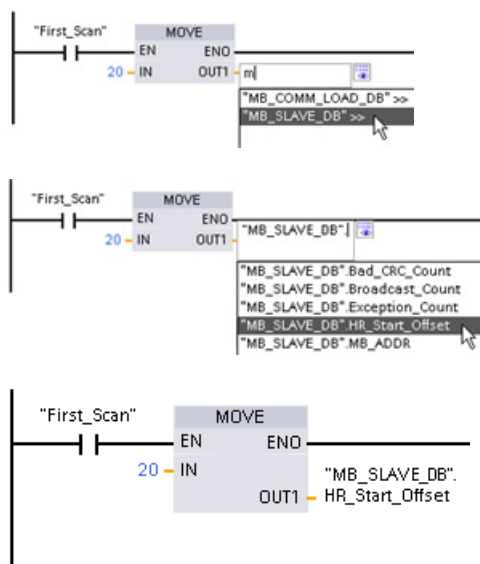

Entering a Modbus slave variable using the default DB name:

1. Set the cursor in the parameter field and type an m character.
2. Select "MB_SLAVE_DB" from the drop-list.
3. Set the cursor at the right side of the DB name (after the quote character) and enter a period character.
4. Select "MB_SLAVE_DB.HR_Start_Offset" from the drop list.

Extended Addressing

The Extended Addressing variable is accessed in a similar way as the HR_Start_Offset reference discussed above except that the Extended Addressing variable is a Boolean value. The Boolean value must be written by an output coil and not a move box.

Modbus slave addressing can be configured to be either a single byte (which is the Modbus standard) or double byte. Extended addressing is used to address more than 247 devices within a single network. Selecting extended addressing allows you to address a maximum of 64000 addresses. A Modbus function 1 frame is shown below as an example.

Table 12- 80 Single-byte slave address (byte 0)

| Function 1 | Byte 0 | Byte 1 | Byte 2 | Byte 3 | Byte 4 | Byte 5 | |
|----------------|-------------|--------|---------------|-----------|-----------------|--------|--|
| Request | Slave addr. | F code | Start address | | Length of coils | | |
| Valid Response | Slave addr. | F code | Length | Coil data | | | |
| Error response | Slave addr. | 0x81 | E code | | | | |

Table 12- 81 Double-byte slave address (byte 0 and byte 1)

| | Byte 0 | Byte 1 | Byte 2 | Byte 3 | Byte 4 | Byte 5 | Byte 6 |
|----------------|---------------|--------|--------|---------------|-----------|-----------------|--------|
| Request | Slave address | | F code | Start address | | Length of coils | |
| Valid Response | Slave address | | F code | Length | Coil data | | |
| Error response | Slave address | | 0x81 | E code | | | |

Condition codes

Table 12- 82 MB_SLAVE execution condition codes (communication and configuration errors) ¹

| STATUS (W#16#) | Description |
|----------------|---|
| 80D1 | The receiver issued a flow control request to suspend an active transmission and never re-enabled the transmission during the specified wait time. This error is also generated during hardware flow control when the receiver does not assert CTS within the specified wait time. |
| 80D2 | The transmit request was aborted because no DSR signal is received from the DCE. |
| 80E0 | The message was terminated because the receive buffer is full. |
| 80E1 | The message was terminated as a result of a parity error. |
| 80E2 | The message was terminated as a result of a framing error. |
| 80E3 | The message was terminated as a result of an overrun error. |
| 80E4 | The message was terminated as a result of the specified length exceeding the total buffer size. |
| 8180 | Invalid port ID value or error with MB_COMM_LOAD instruction |
| 8186 | Invalid Modbus station address |
| 8187 | Invalid pointer to MB_HOLD_REG DB: Area is too small |
| 818C | Invalid MB_HOLD_REG pointer to M memory or DB (DB area must allow both symbolic and direct address) |

Table 12- 83 MB_SLAVE execution condition codes (Modbus protocol errors) ¹

| STATUS (W#16#) | Response code from slave | Modbus protocol errors |
|----------------|--------------------------|--|
| 8380 | No response | CRC error |
| 8381 | 01 | Function code not supported or not supported within broadcasts |
| 8382 | 03 | Data length error |
| 8383 | 02 | Data address error or address outside the valid range of the DATA_PTR area |
| 8384 | 03 | Data value error |
| 8385 | 03 | Data diagnostic code value not supported (function code 08) |

¹ In addition to the MB_SLAVE errors listed above, errors can be returned from the underlying PtP communication instructions.

12.5.3.4 Modbus RTU master example program

MB_COMM_LOAD is initialized during start-up by using the first scan flag. Execution of MB_COMM_LOAD in this manner should only be done when the serial port configuration will not change at runtime.

Network 1 Initialize the RS485 module parameters only once during the first scan.

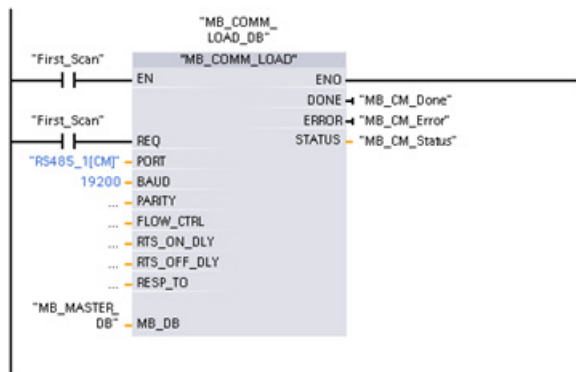

One MB_MASTER instruction is used in the program cycle OB to communicate with a single slave. Additional MB_MASTER instructions can be used in the program cycle OB to communicate with other slaves, or one MB_MASTER FB could be re-used to communicate with additional slaves.

Network 2 Read 100 words from the slave holding register.

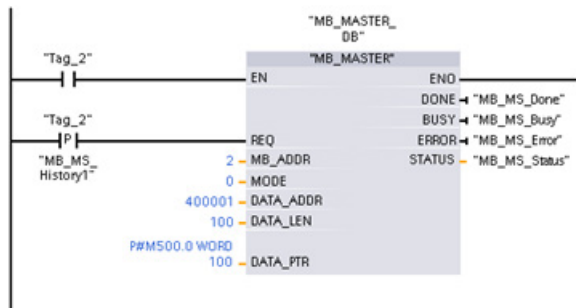

Network 3 This is an optional network that just shows the values of the first 3 words once the read operation is done.

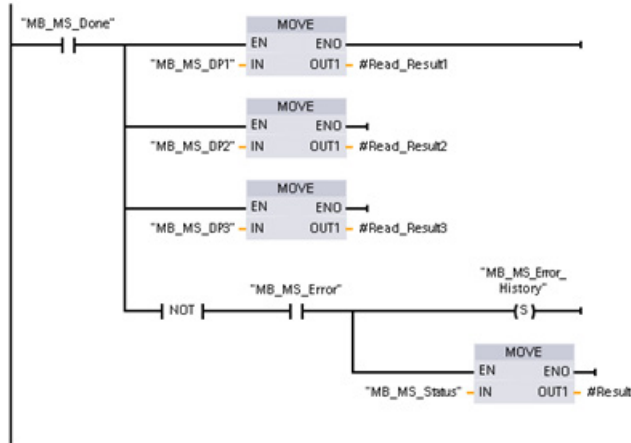

Network 4 Write 64 bits to the output image register starting at slave address Q2.0.

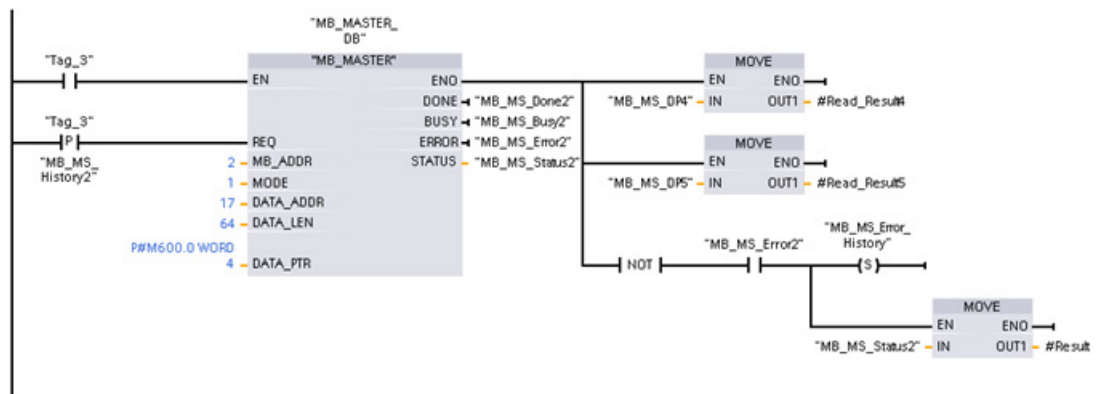

12.5.3.5 Modbus RTU slave example program

MB_COMM_LOAD shown below is initialized each time "Tag_1" is enabled.

Execution of MB_COMM_LOAD in this manner should only be done when the serial port configuration will change at runtime, as a result of HMI configuration.

Network 1 Initialize the RS485 module parameters each time they are changed by an HMI device.

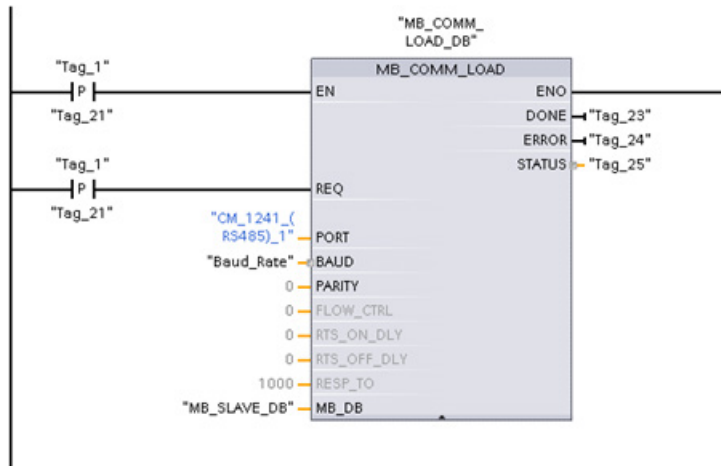

MB_SLAVE shown below is placed in a cyclic OB that is executed every 10ms. While this does not give the absolute fastest response by the slave, it does provide good performance at 9600 baud for short messages (20 bytes or less in the request).

Network 2 Check for Modbus master requests during each scan. The Modbus holding register is configured for 100 words starting at MW1000.

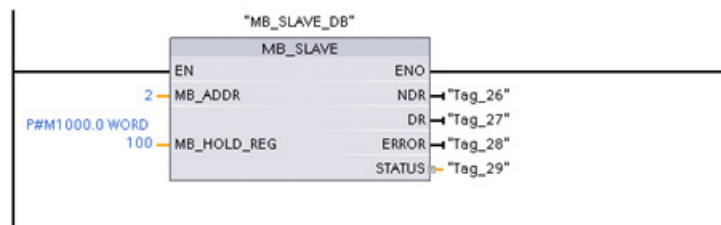

12.6 Telecontrol and TeleService with the CP 1242-7

12.6.1 Connection to a GSM network

IP-based WAN communication via GPRS

Using the CP 1242-7 communications processor, the S7-1200 can be connected to GSM networks. The CP 1242-7 allows WAN communication from remote stations with a control center and inter-station communication.

Inter-station communication is possible only via a GSM network. For communication between a remote station and a control room, the control center must have a PC with Internet access.

The CP 1242-7 supports the following services for communication via the GSM network:

- GPRS (General Packet Radio Service)

The packet-oriented service for data transmission "GPRS" is handled via the GSM network.

- SMS (Short Message Service)

The CP 1242-7 can receive and send SMS messages. The communications partner can be a mobile phone or an S7-1200.

The CP 1242-7 is suitable for use in industry worldwide and supports the following frequency bands:

- 850 MHz
- 900 MHz
- 1 800 MHz
- 1 900 MHz

Requirements

The equipment used in the stations or the control center depends on the particular application.

- For communication with or via a central control room, the control center requires a PC with Internet access.
- Apart from the station equipment, a remote S7-1200 station with a CP 1242-7 must meet the following requirements to be able to communicate via the GSM network:
 - A contract with a suitable GSM network provider
 - If GPRS is used, the contract must allow the use of the GPRS service.
 - If there is to be direct communication between stations only via the GSM network, the GSM network provider must assign a fixed IP address to the CPs. In this case, communication between stations is not via the control center.
 - The SIM card belonging to the contract
 - The SIM card is inserted in the CP 1242-7.
 - Local availability of a GSM network in the range of the station

12.6.2 Applications of the CP 1242-7

The CP 1242-7 can be used for the following applications:

Telecontrol applications

- Sending messages by SMS

Via the CP 1242-7, the CPU of a remote S7-1200 station can receive SMS messages from the GSM network or send messages by SMS to a configured mobile phone or an S7-1200.

- Communication with a control center

Remote S7-1200 stations communicate via the GSM network and the Internet with a telecontrol server in the master station. For data transfer using GPRS, the "TELECONTROL SERVER BASIC" application is installed on the telecontrol server in the master station. The telecontrol server communicates with a higher-level central control system using the integrated OPC server function.

- Communication between S7-1200 stations via a GSM network

Communication between remote stations with a CP 1242-7 can be handled in two different ways:

- Inter-station communication via a master station

In this configuration, a permanent secure connection between S7-1200 stations that communicate with each other and the telecontrol server is established in the master station. Communication between the stations is via the telecontrol server. The CP 1242-7 operates in "Telecontrol" mode.

- Direct communication between the stations

For direct communication between stations without the detour via the master station, SIM cards with a fixed IP address are used that allow the stations to address each other directly. The possible communications services and security functions (for example VPN) depend on what is offered by the network provider. The CP 1242-7 operates in "GPRS direct" mode.

TeleService via GPRS

A TeleService connection can be established between an engineering station with STEP 7 and a remote S7-1200 station with a CP 1242-7 via the GSM network and the Internet. The connection runs from the engineering station via a telecontrol server or a TeleService gateway that acts as an intermediary forwarding frames and establishing the authorization. These PCs use the functions of the "TELECONTROL SERVER BASIC" application.

You can use the TeleService connection for the following purposes:

- Downloading configuration or program data from the STEP 7 project to the station
- Querying diagnostics data on the station

12.6.3 Other properties of the CP

Other services and functions of the CP 1242-7

- Time-of-day synchronization of the CP via the Internet

You can set the time on the CP as follows:

- In "Telecontrol" mode, the time of day is transferred by the telecontrol server. The CP uses this to set its time.
- In "GPRS direct" mode, the CP can request the time using SNTP.

To synchronize the CPU time, you can read out the current time from the CP using a block.

- Interim buffering of messages to be sent if there are connection problems
- Increased availability thanks to the option of connecting to a substitute telecontrol server
- Optimized data volume (temporary connection)

As an alternative to a permanent connection to the telecontrol server, the CP can be configured in STEP 7 with a temporary connection to the telecontrol server. In this case, a connection to the telecontrol server is established only when required.

- Logging the volume of data

The volumes of data transferred are logged and can be evaluated for specific purposes.

Configuration and module replacement

To configure the module, the following configuration tool is required:

STEP 7 version V11.0 SP1 or higher

For STEP 7 V11.0 SP1, you also require support package "CP 1242-7" (HSP0003001).

For process data transfer using GPRS, use the telecontrol communications instructions in the user program of the station.

The configuration data of the CP 1242-7 is stored on the local CPU. This allows simple replacement of the CP when necessary.

You can insert up to three modules of the CP 1242-7 type per S7-1200. This, for example, allows redundant communications paths to be established.

Electrical connections

- Power supply of the CP 1242-7

The CP has a separate connection for the external 24 VDC power supply.

- Wireless interface for the GSM network

An extra antenna is required for GSM communication. This is connected via the SMA socket of the CP.

Further information

The CP 1242-7 manual contains detailed information. You will find this on the Internet on the pages of Siemens Industrial Automation Customer Support under the following entry ID:

45605894 (<http://support.automation.siemens.com/WW/view/en/45605894>)

12.6.4 Accessories

The ANT794-4MR GSM/GPRS antenna

The following antennas are available for use in GSM/GPRS networks and can be installed both indoors and outdoors:

- Quadband antenna ANT794-4MR



Figure 12-1 ANT794-4MR GSM/GPRS antenna

| Short name | Order no. | Explanation |
|------------|----------------|--|
| ANT794-4MR | 6NH9 860-1AA00 | Quadband antenna (900, 1800/1900 MHz, UMTS); weatherproof for indoor and outdoor areas; 5 m connecting cable connected permanently to the antenna; SMA connector, including installation bracket, screws, wall plugs |

- Flat antenna ANT794-3M



Figure 12-2 Flat antenna ANT794-3M

| Short name | Order no. | Explanation |
|------------|----------------|--|
| ANT794-3M | 6NH9 870-1AA00 | Flat antenna (900, 1800/1900 MHz); weatherproof for indoor and outdoor areas; 1.2 m connecting cable connected permanently to the antenna; SMA connector, including adhesive pad, screws mounting possible |

The antennas must be ordered separately.

Further information

You will find detailed information in the device manual. You will find this on the Internet on the pages of Siemens Industrial Automation Customer Support under the following entry ID:

23119005 (<http://support.automation.siemens.com/WW/view/en/23119005>)

12.6.5 Configuration examples for telecontrol

Below, you will find several configuration examples for stations with a CP 1242-7.

Sending messages by SMS

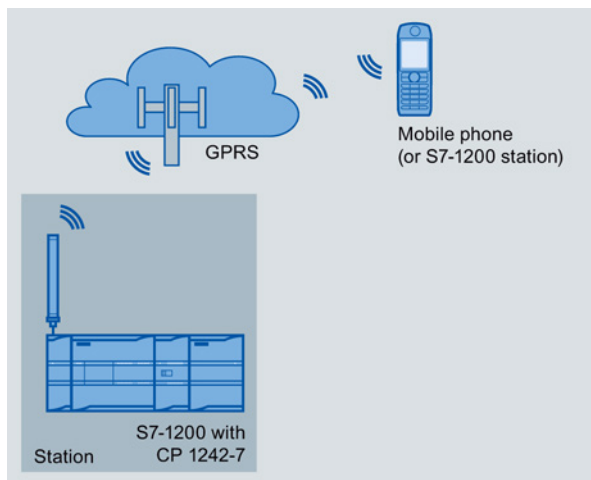

Figure 12-3 Sending messages by SMS from an S7-1200 station

A SIMATIC S7-1200 with a CP 1242-7 can send messages by SMS to a mobile phone or a configured S7-1200 station.

Telecontrol by a control center

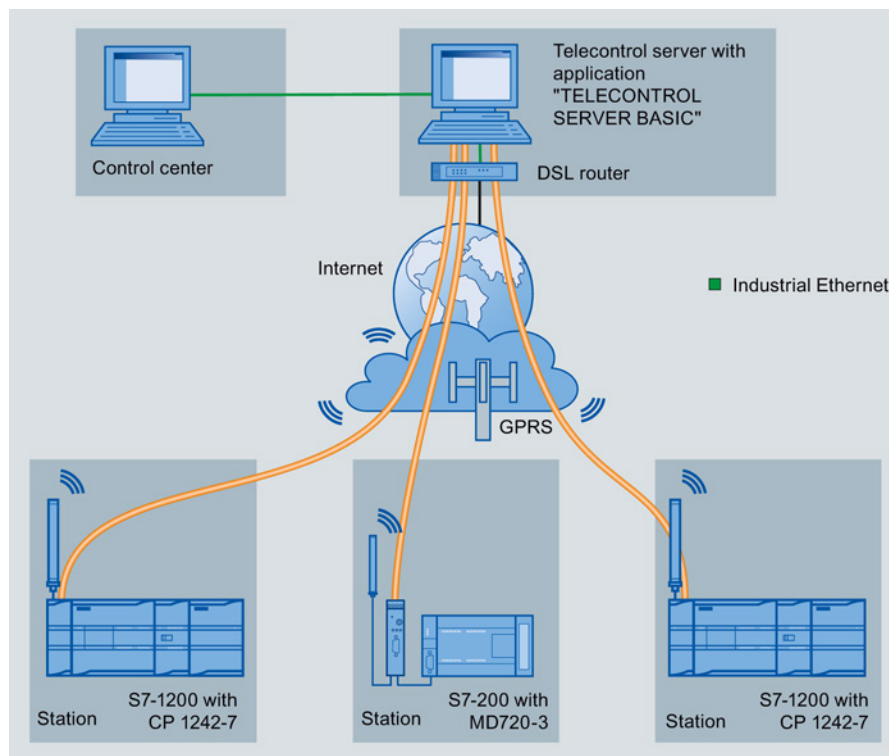

Figure 12-4 Communication between S7-1200 stations and a control center

In telecontrol applications, SIMATIC S7-1200 stations with a CP 1242-7 communicate with a control center via the GSM network and the Internet. The "TELECONTROL SERVER BASIC" (TCSB) application is installed on the telecontrol server in the master station. This results in the following use cases:

- Telecontrol communication between station and control center

In this use case, data from the field is sent by the stations to the telecontrol server in the master station via the GSM network and Internet. The telecontrol server is used to monitor remote stations.

- Communication between a station and a control room with OPC client

As in the first case, the stations communicate with the telecontrol server. Using its integrated OPC server, the telecontrol server exchanges data with the OPC client of the control room.

The OPC client and telecontrol server can be located on a single computer, for example when TCSB is installed on a control center computer with WinCC.

- Inter-station communication via a control center

Inter-station communication is possible with S7 stations equipped with a CP 1242-7.

To allow inter-station communication, the telecontrol server forwards the messages of the sending station to the receiving station.

Direct communication between stations

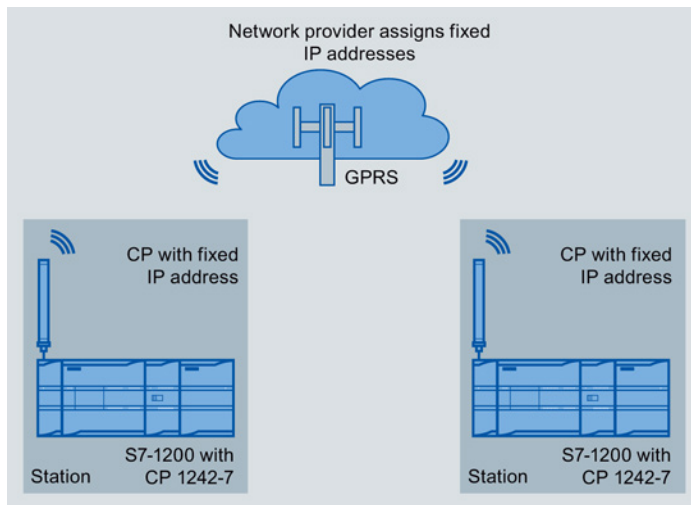

Figure 12-5 Direct communication between two S7-1200 stations

In this configuration, two SIMATIC S7-1200 stations communicate directly with each other using the CP 1242-7 via the GSM network. Each CP 1242-7 has a fixed IP address. The relevant service of the GSM network provider must allow this.

TeleService via GPRS

In TeleService via GPRS, an engineering station on which STEP 7 is installed communicates via the GSM network and the Internet with the CP 1242-7 in the S7-1200.

Since a firewall is normally closed for connection requests from the outside, a switching station between the remote station and the engineering station is required. This switching station can be a telecontrol server or, if there is no telecontrol server in the configuration, a TeleService gateway.

TeleService with telecontrol server

The connection runs via the telecontrol server.

- The engineering station and telecontrol server are connected via the Intranet (LAN) or Internet.
- The telecontrol server and remote station are connected via the Internet and via the GSM network.

The engineering station and telecontrol server can also be the same computer; in other words, STEP 7 and TCSB are installed on the same computer.

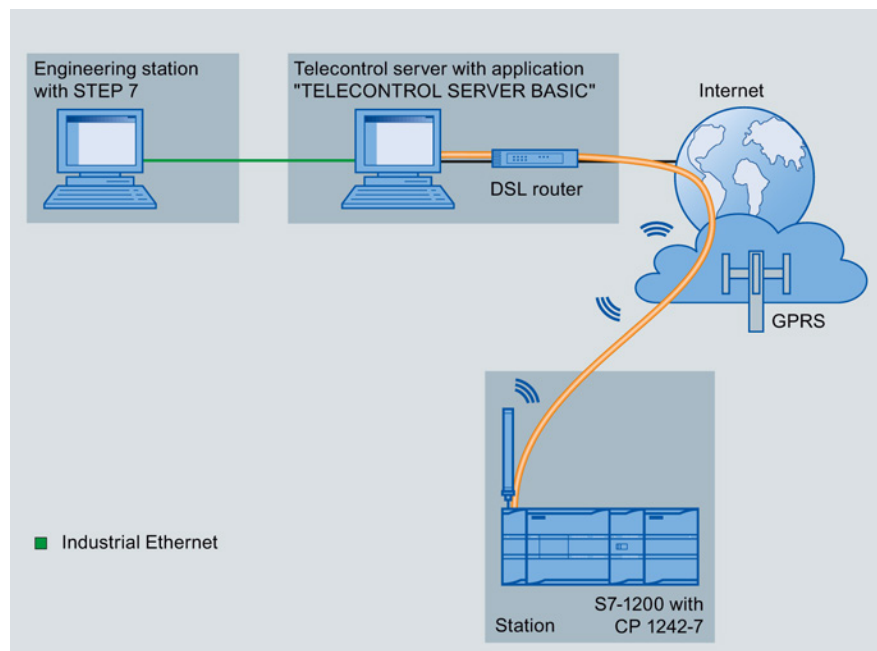

Figure 12-6 TeleService via GPRS in a configuration with telecontrol server

TeleService without a telecontrol server

The connection runs via the TeleService gateway.

The connection between the engineering station and the TeleService gateway can be local via a LAN or via the Internet.

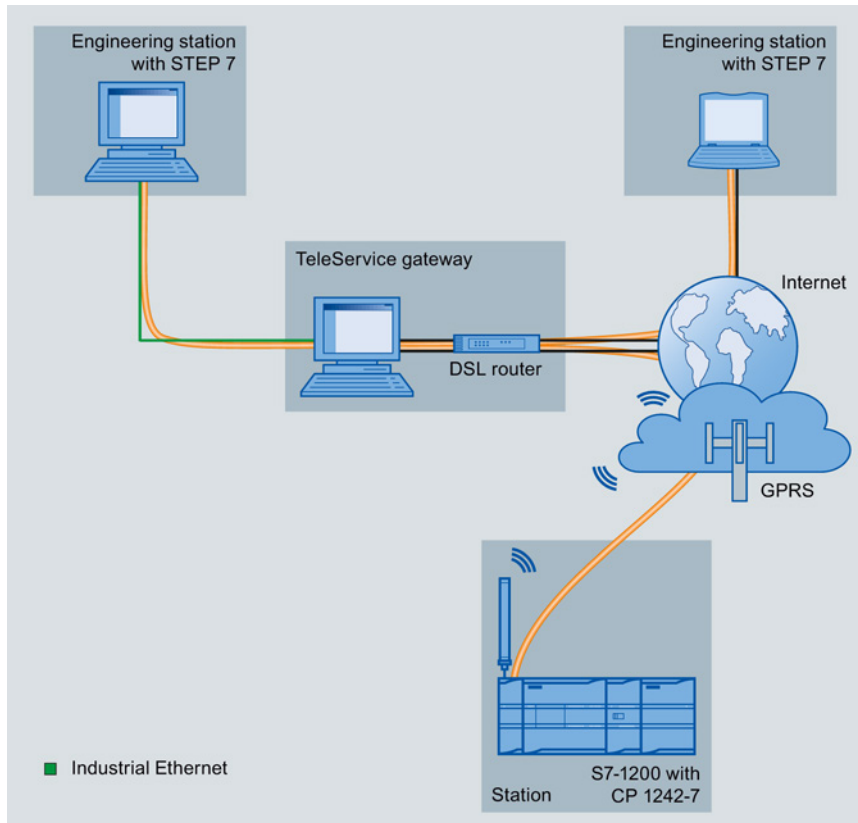

Figure 12-7 TeleService via GPRS in a configuration with TeleService gateway

Teleservice communication (SMTP email)

13.1 TM_Mail (Send email) instruction

Table 13- 1 TM_MAIL instruction

| LAD / FBD | SCL | Description |
|-----------|---|---|
| | <pre>"TM_MAIL_DB" (REQ:=_bool_in_, ID:=_int_in_, TO_S:=_string_in_, CC:=_string_in_, SUBJECT:=_string_in_, TEXT:=_string_in_, ATTACHMENT:=_variant_in_, BUSY=>_bool_out_, DONE=>_bool_out_, ERROR=>_bool_out_, STATUS=>_word_out_,);</pre> | <p>The TM_MAIL instruction sends an email message using the SMTP (Simple Mail Transfer Protocol) over TCP/IP via the CPU Industrial Ethernet connection. Where Ethernet-based Internet connectivity is not available, an optional Teleservice adapter can be used for connection with telephone land lines. TM_MAIL executes asynchronously and the job extends over multiple TM_MAIL calls. When you call TM_MAIL, you must assign an instance DB. The instance DB retentive attribute must not be set. This ensures that the instance DB is initialized in the transition of the CPU from STOP to RUN and that a new TM_MAIL operation can be triggered.</p> |

¹ STEP 7 automatically creates the instance DB when you insert the instruction.

You start sending an email with a positive edge change from 0 to 1, at input parameter REQ. The following table shows the relationship between BUSY, DONE and ERROR. You can monitor the progress of TM_MAIL execution and detect completion, by evaluating these parameters in successive calls.

The output parameters DONE, ERROR, STATUS, and SFC_STATUS are valid for only one cycle, when the state of the output parameter BUSY changes from 1 to 0. Your program logic must save temporary output state values, so you can detect state changes in subsequent program execution cycles.

Table 13- 2 Interaction of the Done, Busy and Error parameters

| DONE | BUSY | ERROR | Description |
|------------|------|------------|--|
| Irrelevant | 1 | Irrelevant | Job is in progress. |
| 1 | 0 | 0 | The job was completed successfully. |
| 0 | 0 | 1 | The job was terminated with an error. For the cause of the error, refer to the STATUS parameter. |
| 0 | 0 | 0 | No job in progress |

13.1 TM_Mail (Send email) instruction

If the CPU is changed to STOP mode while TM_MAIL is active, then the communication connection to the email server is terminated. The communication connection to the email server is also lost if problems occur in CPU communication on the Industrial Ethernet bus. In these cases, the send process is suspended and the email does not reach the recipient.

| |
|---|
| <p>NOTICE</p> <p>Modifying user programs</p> <p>Deletion and replacement of program blocks, the calls to TM_MAIL, or calls to the instance DBs of TM_MAIL can break the linking of program blocks. If you fail to maintain linked program blocks, then the TPC/IP communication functions can enter an undefined state, possibly resulting in property damage. After transferring a modified program block, you would have to perform a CPU restart (warm) or cold start.</p> <p>To avoid breaking the linking of program blocks, only change the parts of your user program that directly affect the TM_MAIL calls in the following cases:</p> <ul style="list-style-type: none"> • The CPU in the STOP mode • No email is sent (REQ and BUSY = 0) |
|---|

Data consistency

The input parameter ADDR_MAIL_SERVER is read when the operation is started. A new value does not take effect until the current operation is complete and a new TM_MAIL operation is initiated.

In contrast, the parameters WATCH_DOG_TIME, TO_S, CC, FROM, SUBJECT, TEXT, ATTACHMENT, USERNAME and PASSWORD are read during the execution of TM_MAIL and may be changed only when the job is finished (BUSY = 0)

Dial-up connection: Configuring the TS adapter IE parameters

You must configure the Teleservice adapter IE parameters for outgoing calls to connect with the dial-up server of your Internet Service Provider. If you set the call "on demand" attribute, then the connection is established only when an e-mail will be sent. For an analog modem connection, more time is required for the connection process (approx. a minute longer). You must include the extra time, in the WATCH_DOG_TIME value.

Table 13- 3 Data types for the parameters

| Parameter and type | | Data types | Description |
|--------------------|----|------------|--|
| REQ | IN | Bool | A low to high (positive edge) signal starts the operation. |
| ID | IN | Int | Connection identifier: See the ID parameter of the instructions TCON, TDISCON, TSEND and TRCV. A number that is not used for any additional instances of this instruction in the user program must be used. |
| TO_S | IN | String | Recipient addresses: STRING data with a maximum length of 240 characters |
| CC | IN | String | CC copy to recipient addresses (optional): STRING data with a maximum length of 240 characters |

| Parameter and type | | Data types | Description |
|--------------------|---------------------|------------|--|
| SUBJECT | IN | String | Subject name of the email: STRING data with a maximum length 240 characters. |
| TEXT | IN | String | Text message of the email (optional): STRING data with a maximum length of 240 characters. If this parameter is an empty string, then the email will be sent without message text. |
| ATTACHMENT | IN | VARIANT | Pointer to email attachment data: Byte, word, or double word data with a maximum length of 65534 bytes. If no value is assigned, then the email sent without an attachment. |
| DONE | OUT | Bool | <ul style="list-style-type: none"> 0 - Job not yet started or still executing. 1 - Job was executed error-free. |
| BUSY | OUT | Bool | <ul style="list-style-type: none"> 0 - No operation in progress 1 - Operation in progress |
| ERROR | OUT | Bool | The ERROR bit =1 for one scan, after the last request was terminated with an error. The error code value at the STATUS output is valid only during the single scan where ERROR = 1. |
| STATUS | OUT | Word | Return value or error information of the TM_MAIL instruction. |
| ADDR_MAIL_SERVER | ¹ Static | DWord | IP address of the mail server: You must assign each IP address fragment as an octet of two 4-bit hexadecimal characters. If the IP address fragment = decimal value 10 which equals hexadecimal value A, then you must enter "0A" for that octet. For example: IP address = 192.168.0.10 ADDR_MAIL_SERVER = DW#16#C0A8000A, where: <ul style="list-style-type: none"> 192 = 16#C0, 168 =16#A8 0 = 16#00 10 = 16#0A |
| WATCH_DOG_TIME | ¹ Static | Time | The maximum time allowed for TM_MAIL to complete the entire SMTP process, from the initiation of the connection to the SMTP to the end of the SMTP transmission. If this time is exceeded, then TM_MAIL execution ends with an error. The actual time delay until TM_MAIL ends and the error is issued may exceed the WATCH_DOG_TIME, because of the additional time required for the disconnect operation. At first you should set a time of 2 minutes. This time can be much smaller for an ISDN phone connection. |
| USERNAME | ¹ Static | String | Mail account user name: STRING data with a maximum length 180 characters. |
| PASSWORD | ¹ Static | String | Mail server password: STRING data with a maximum length 180 characters. |

13.1 TM_Mail (Send email) instruction

| Parameter and type | | Data types | Description |
|--------------------|---------------------|------------|--|
| FROM | ¹ Static | String | Sender address: STRING with a maximum length of 240 characters |
| SFC_STATUS | ¹ Static | Word | Execution condition code of the called communication blocks |

¹ The values of these parameters are not modified at every call of TM_MAIL. The values are assigned in the TM_MAIL instance data block and are only referenced once, on the first call of TM_MAIL.

SMTP authentication

TM_MAIL supports the SMTP AUTH LOGIN authentication method. For information on this authentication method, please refer to the manual of the mail server or the website of your internet service provider.

The AUTH LOGIN authentication method uses the TM_MAIL USERNAME and PASSWORD parameters to connect with the mail server. The user name and password must be previously set up on an email account at an email server.

If no value is assigned for the USERNAME parameter, then the AUTH LOGIN authentication method is not used and the email is sent without authentication.

TO_S:, CC:, and FROM: parameters

The parameters TO_S:, CC: and FROM: are strings, as shown in the following examples:

TO: <wenna@mydomain.com>, <ruby@mydomain.com> ,

CC: <admin@mydomain.com>, <judy@mydomain.com> ,

FROM: <admin@mydomain.com>

The following rules must be used when entering these character strings:

- The characters "TO:", "CC:" and "FROM:" must be entered, including the colon character.
- A space character and an opening angle bracket "<" must precede each address. For example, there must be a space character between "TO:" and <email address>.
- A closing angle bracket ">" must be entered after each address.
- A comma character "," must be entered after each email address for the TO_S: and CC: addresses. For example, the comma after the single email address is required in "TO: <email address>,".
- Only one email address may be used for the FROM: entry, with no comma at the end.

Because of run-time mode and memory usage, a syntax check is not performed on the TM_MAIL TO_S:, CC: and FROM: data. If the format rules above are not followed exactly. The SMTP email server transaction will fail.

STATUS and SFC_STATUS parameters

The execution condition codes returned by TM_MAIL can be classified as follows:

- W#16#0000: Operation of TM_MAIL was completed successfully
- W#16#7xxx: Status of TM_MAIL operation
- W#16#8xxx: An error in an internal call to a communication device or the mail server

The following table shows the execution condition codes of TM_MAIL with the exception of the error codes from internally called communication modules.

Note

Email server requirements

TM_MAIL can only communicate with an email server using SMTP via port 25. The assigned port number cannot be changed.

Most IT departments and external email servers now block port 25 to prevent a PC infected with a virus from becoming a rogue email generator.

You can connect to an internal mail server via SMTP and let the internal server manage the current security enhancements that are required to relay email through the Internet to an external mail server.

Internal email server configuration example

If you use Microsoft Exchange as an internal mail server, then you can configure the server to allow SMTP access from the IP address assigned the S7-1200 PLC. Configure the Exchange management console: Server configuration > Hub transport > Receive connectors > IP relay. On the Network tab, there is a box named "Receive mail from remote servers that have these IP addresses". This is where you put the IP address of the PLC that is executing the TM_MAIL instruction. No authentication is required for this type of connection with an internal Microsoft Exchange server.

Email server configuration

TM_MAIL can only use an email server that allows port 25 communication, SMTP, and AUTH LOGIN authentication (optional).

Configure a compatible email server account to accept remote SMTP log in. Then edit the instance DB for TM_MAIL to put in the TM_MAIL USERNAME and PASSWORD character strings that are used to authenticate the connection with your email account.

13.1 TM_Mail (Send email) instruction

Table 13- 4 Condition codes

| STATUS (W#16#...): | SFC_STATUS (W#16#...): | Description |
|-----------------------|---------------------------|--|
| 0000 | - | The TM_MAIL operation completed without error. This zero STATUS code does not guarantee that an email was actually sent (See the first item in the note following this table). |
| 7001 | - | TM_MAIL is active (BUSY = 1). |
| 7002 | 7002 | TM_MAIL is active (BUSY = 1). |
| 8xxx | xxxx | The TM_MAIL operation was completed with an error in the internal communication instruction calls. For more information about the SFC_STATUS parameter, see the descriptions of the STATUS parameter of the underlying PROFINET open user communication instructions. |
| 8010 | xxxx | Failed to connect: For more information about the SFC_STATUS parameter, see the STATUS parameter of the TCON instruction. |
| 8011 | xxxx | Error sending data: For more information about SFC_STATUS parameter, see the STATUS parameter of the TSEND instruction. |
| 8012 | xxxx | Error while receiving data: For more information about the SFC_STATUS parameter, see the STATUS parameter descriptions of the TRCV instruction. |
| 8013 | xxxx | Failed to connect: For more information for evaluating the SFC_STATUS parameter, see the STATUS parameter descriptions of the TCON and TDISCON instructions. |
| 8014 | - | Failed to connect: You may have entered an incorrect mail server IP address (ADDR_MAIL_SERVER) or too little time (WATCH_DOG_TIME) for the connection. It is also possible that the CPU has no connection to the network or the CPU configuration is incorrect. |
| 8015 | - | Invalid pointer for ATTACHMENT parameter: Use a variant pointer with a data type and length assignment. For example, "P#DB.DBX0.0" is incorrect and "P#DB.DBX0.0 byte 256" is correct. |
| 82xx, 84xx, 85xx | - | The error message comes from the mail server and corresponds to error number "8" of the SMTP protocol. See the second item in the note following this table. |
| 8450 | - | Operation does not run: Mailbox is not available; try again later. |
| 8451 | - | Operation aborted: Local error in processing, .try again later |
| 8500 | - | Command syntax error: The cause may be that the email server does not support the LOGIN authentication process. Check the parameters of TM_MAIL. Try to send an email without authentication. Try replacing the parameter USERNAME with an empty string. |
| 8501 | - | Syntax error: Incorrect parameter or argument; you may have typed an incorrect address in the TO_S or CC parameters. |
| 8502 | - | Command is unknown or not implemented: Check your entries, especially the parameter FROM. Perhaps this is incomplete and you have omitted the "@" or "." characters. |
| 8535 | - | SMTP authentication is incomplete. You may have entered an incorrect username or password. |
| 8550 | - | The mail server cannot be reached, or you have no access rights. You may have entered an incorrect username or password or your mail server does not support log in access. Another cause of this error could be an erroneous entry of the domain name after the "@" character in the TO_S or CC parameters. |
| 8552 | - | Operation aborted: Exceeded the allocated memory size; try again later. |
| 8554 | - | Transmission failed: Try again later. |

Note

Possible unreported email transmission errors

- Incorrect entry of a recipient address does not generate a STATUS error for TM_MAIL. In this case, there is no guarantee that additional recipients (with correct email addresses), will receive the email.
 - More information on SMTP error codes can be found on the internet or in the error documentation for the mail server. You can also read the last error message from the mail server. The error message is stored in buffer1parameter of the instance DB for TM_MAIL.
-

Online and diagnostic tools

14.1 Status LEDs

The CPU and the I/O modules use LEDs to provide information about either the operational status of the module or the I/O.

Status LEDs on a CPU

The CPU provides the following status indicators:

- STOP/RUN
 - Solid yellow indicates STOP mode
 - Solid green indicates RUN mode
 - Flashing (alternating green and yellow) indicates that the CPU is in STARTUP mode
- ERROR
 - Flashing red indicates an error, such as an internal error in the CPU, a error with the memory card, or a configuration error (mismatched modules)
 - Defective state:
 - Solid red indicates defective hardware
 - All LEDs flash if the defect is detected in the firmware
- MAINT (Maintenance) flashes whenever you insert a memory card. The CPU then changes to STOP mode. After the CPU has changed to STOP mode, perform one of the following functions to initiate the evaluation of the memory card:
 - Change the CPU to RUN mode
 - Perform a memory reset (MRES)
 - Power-cycle the CPU

You can also use the LED instruction (Page 346) to determine the status of the LEDs.

Table 14- 1 Status LEDs for a CPU

| Description | STOP/RUN Yellow / Green | ERROR Red | MAINT Yellow |
|--|--|--------------|-----------------|
| Power is off | Off | Off | Off |
| Startup, self-test, or firmware update | Flashing (alternating yellow and green) | - | Off |
| Stop mode | On (yellow) | - | - |
| Run mode | On (green) | - | - |
| Remove the memory card | On (yellow) | - | Flashing |
| Error | On (either yellow or green) | Flashing | - |

| Description | STOP/RUN Yellow / Green | ERROR Red | MAINT Yellow |
|---|---|--------------|-----------------|
| Maintenance requested <ul style="list-style-type: none"> • Forced I/O • Battery replacement required (if battery board installed) | On (either yellow or green) | - | On |
| Defective hardware | On (yellow) | On | Off |
| LED test or defective CPU firmware | Flashing (alternating yellow and green) | Flashing | Flashing |
| Unknown or incompatible version of CPU configuration | On (yellow) | Flashing | Flashing |

Note

"Unknown or incompatible version of CPU configuration" error

Attempting to download an S7-1200 V3.0 program to an S7-1200 V4.0 CPU causes a CPU error, and the CPU displays a corresponding error message in the diagnostic buffer. If you reached this state by using an invalid version program transfer card (Page 127), then remove the card, perform a STOP to RUN transition, a memory reset (MRES) or cycle power. If you reach this state by an invalid program download, reset the CPU to factory settings (Page 789). After you recover the CPU from the error condition, you can download a valid V4.0 CPU program.

The CPU also provides two LEDs that indicate the status of the PROFINET communications. Open the bottom terminal block cover to view the PROFINET LEDs.

- Link (green) turns on to indicate a successful connection
- Rx/Tx (yellow) turns on to indicate transmission activity

The CPU and each digital signal module (SM) provide an I/O Channel LED for each of the digital inputs and outputs. The I/O Channel (green) turns on or off to indicate the state of the individual input or output.

S7-1200 behavior following a fatal error

If the CPU firmware detects a fatal error it attempts a defect-mode restart, and if successful, signals the defective mode by continually flashing the STOP/RUN, ERROR and MAINT LEDs. The user program and hardware configuration are not loaded following the defect-mode restart.

If the CPU successfully completes the defect-mode restart, the CPU and signal board outputs are set to 0, and the outputs of central rack signal modules and distributed I/O are set to the configured "Reaction to CPU STOP".

If the defect-mode restart fails, (for example, due to a hardware fault), the STOP and ERROR LEDs are ON and the MAINT LED is OFF.

| |
|--|
|  WARNING |
| <p>Operation in defect state cannot be guaranteed</p> <p>Control devices can fail in an unsafe condition, resulting in unexpected operation of controlled equipment. Such unexpected operations could result in death or serious injury to personnel, and/or damage to equipment.</p> <p>Use an emergency stop function, electromechanical overrides or other redundant safeguards that are independent of the PLC.</p> |

Status LEDs on an SM

In addition, each digital SM provides a DIAG LED that indicates the status of the module:

- Green indicates that the module is operational
- Red indicates that the module is defective or non-operational

Each analog SM provides an I/O Channel LED for each of the analog inputs and outputs.

- Green indicates that the channel has been configured and is active
- Red indicates an error condition of the individual analog input or output

In addition, each analog SM provides a DIAG LED that indicates the status of the module:

- Green indicates that the module is operational
- Red indicates that the module is defective or non-operational

The SM detects the presence or absence of power to the module (field-side power, if required).

Table 14- 2 Status LEDs for a signal module (SM)

| Description | DIAG (Red / Green) | I/O Channel (Red / Green) |
|---------------------------------------|-----------------------|------------------------------|
| Field-side power is off | Flashing red | Flashing red |
| Not configured or update in progress | Flashing green | Off |
| Module configured with no errors | On (green) | On (green) |
| Error condition | Flashing red | - |
| I/O error (with diagnostics enabled) | - | Flashing red |
| I/O error (with diagnostics disabled) | - | On (green) |

14.2 Going online and connecting to a CPU

An online connection between the programming device and CPU is required for loading programs and project engineering data as well as for activities such as the following:

- Testing user programs
- Displaying and changing the operating mode of the CPU (Page 792)
- Displaying and setting the date and time of day of the CPU (Page 789)
- Displaying the module information
- Comparing and synchronizing (Page 794) offline to online program blocks
- Uploading and downloading program blocks
- Displaying diagnostics and the diagnostics buffer (Page 793)
- Using a watch table (Page 798) to test the user program by monitoring and modifying values
- Using a force table to force values in the CPU (Page 801)

To establish an online connection to a configured CPU, click the CPU from the Project Navigation tree and click the "Go online" button from the Project View:

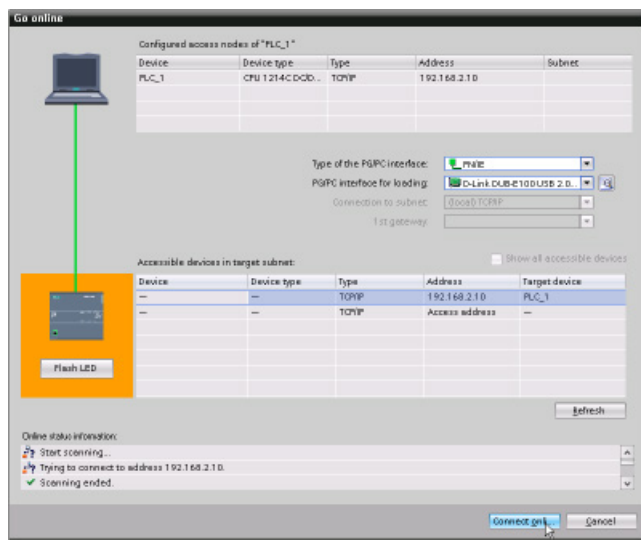
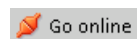

If this is the first time to go online with this CPU, you must select the type of PG/PC interface and the specific PG/PC interface from the Go Online dialog before establishing an online connection to a CPU found on that interface.

Your programming device is now connected to the CPU. The orange color frames indicate an online connection. You can now use the Online & diagnostics tools from the Project tree and the Online tools task card.

14.3 Assigning a name to a PROFINET IO device online

The devices on your PROFINET network must have an assigned name before you can connect with the CPU. Use the "Devices & networks" editor to assign names to your PROFINET devices if the devices have not already been assigned a name or if the name of the device is to be changed.

For each PROFINET IO device, you must assign the same name to that device in both the STEP 7 project and, using the "Online & diagnostics" tool, to the PROFINET IO device configuration memory (for example, an ET200 S interface module configuration memory). If a name is missing or does not match in either location, the PROFINET IO data exchange mode will not run.

14.3 Assigning a name to a PROFINET IO device online

1. In the "Devices & networks" editor, right-click on the required PROFINET IO device, and select "Online & diagnostics".

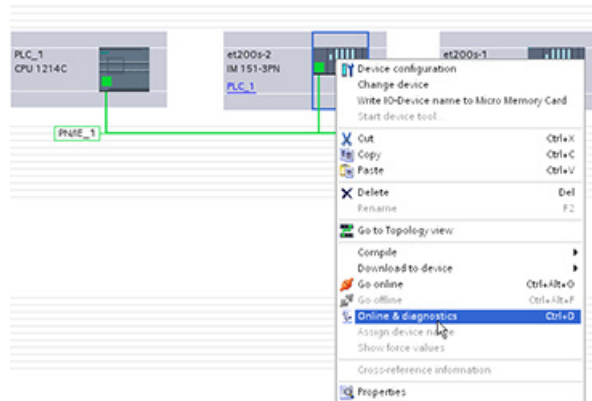

2. In the "Online & diagnostics" dialog, make the following menu selections:

- "Functions"
- "Assign name"

Click the "Accessible devices in the network" icon to display all of the PROFINET IO devices on the network.

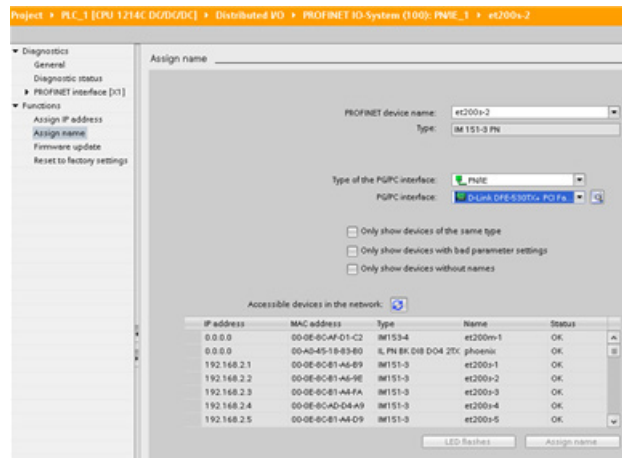

3. In the list that is displayed, click the required PROFINET IO device, and click the "Assign name" button to write the name to the PROFINET IO device configuration memory.

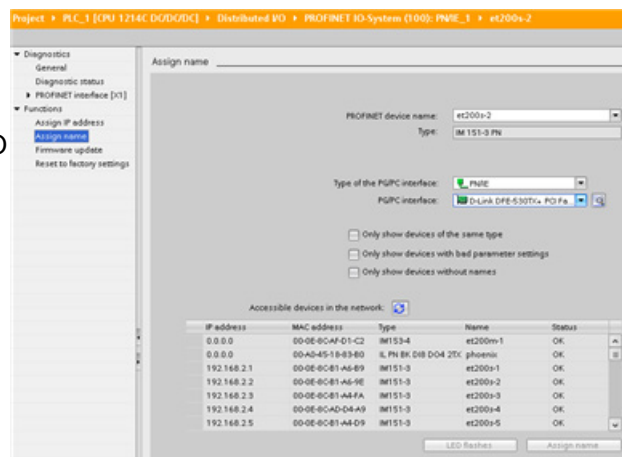

14.4 Setting the IP address and time of day

You can set the IP address (Page 158) and time of day in the online CPU. After accessing "Online & diagnostics" from the Project tree for an online CPU, you can display or change the IP address. You can also display or set the time and date parameters of the online CPU.



Note

This feature is available only for a CPU that either has only a MAC address (has not yet been assigned an IP address) or has been reset to factory settings.

14.5 Resetting to factory settings

You can reset an S7-1200 to its original factory settings under the following conditions:

- No memory card is inserted in the CPU.
- The CPU has an online connection.
- The CPU is in STOP mode.

Note

If the CPU is in RUN mode and you start the reset operation, you can place it in STOP mode after acknowledging a confirmation prompt.

Procedure

To reset a CPU to its factory settings, follow these steps:

1. Open the Online and Diagnostics view of the CPU.
2. Select "Reset to factory settings" from the "Functions" folder.
3. Select the "Keep IP address" check box if you want to retain the IP address or the "Reset IP address" check box if you want to delete the IP address.
4. Click the "Reset" button.
5. Acknowledge the confirmation prompt with "OK".

Result

The module is switched to STOP mode if necessary, and it is reset to the factory settings:

- The work memory and internal load memory and all operand areas are cleared.
- All parameters are reset to their defaults.
- The diagnostics buffer is cleared.
- The time of day is reset.
- The IP address is retained or deleted based on the setting you made. (The MAC address is fixed and is never changed.)

14.6 Updating firmware

You can update the firmware of the connected CPU from the STEP 7 online and diagnostics tools.

To perform a firmware update, follow these steps:

1. Open the Online and Diagnostics view of the connected CPU.
2. Select "Firmware update" from the "Functions" folder.
3. Click the Browse button and navigate to the location that contains the firmware update file. This could be a location on your hard drive to which you have downloaded an S7-1200 (<http://support.automation.siemens.com/WW/view/en/34612486/133100>) firmware update file from the service and support Web site (<http://www.siemens.com/automation/>).
4. Select a file that is compatible with your module. For a selected file, the table displays the compatible modules.
5. Click the "Run update" button. Follow the dialogs, if necessary, to change the operating mode of your CPU.

STEP 7 displays progress dialogs as it loads the firmware update. When it finishes, it prompts you to start the module with the new firmware.

Note

If you do not choose to start the module with the new firmware, the previous firmware remains active until you reset the module, for example by cycling power. The new firmware becomes active only after you reset the module.

You can also perform a firmware update by one of the following additional methods:

- Using a memory card (Page 133)
- Using the Web server "Module Information" standard Web page (Page 616)

14.7 CPU operator panel for the online CPU

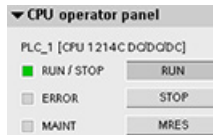

The "CPU operator panel" displays the operating mode (STOP or RUN) of the online CPU. The panel also shows whether the CPU has an error or if values are being forced.

Use the CPU operating panel of the Online Tools task card to change the operating mode of an online CPU. The Online Tools task card is accessible whenever the CPU is online.

14.8 Monitoring the cycle time and memory usage

You can monitor the cycle time and memory usage of an online CPU.

After connecting to the online CPU, open the Online tools task card to view the following measurements:

- Cycle time
- Memory usage

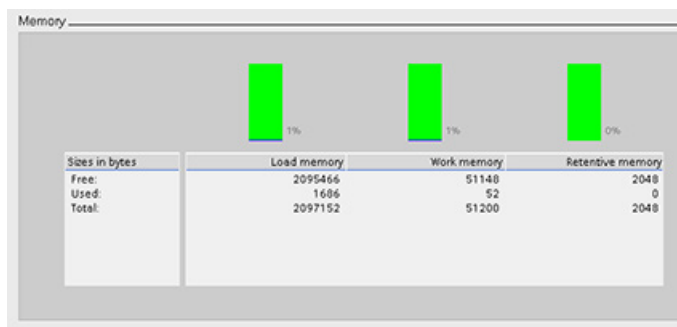
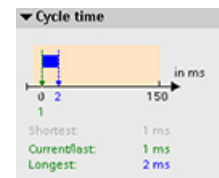
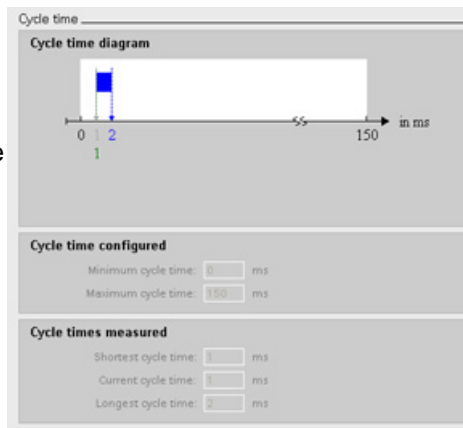

14.9 Displaying diagnostic events in the CPU

Use the diagnostics buffer to review the recent activity in the CPU. The diagnostics buffer is accessible from "Online & Diagnostics" for an online CPU in the Project tree. It contains the following entries:

- Diagnostic events
- Changes in the CPU operating mode (transitions to STOP or RUN mode)

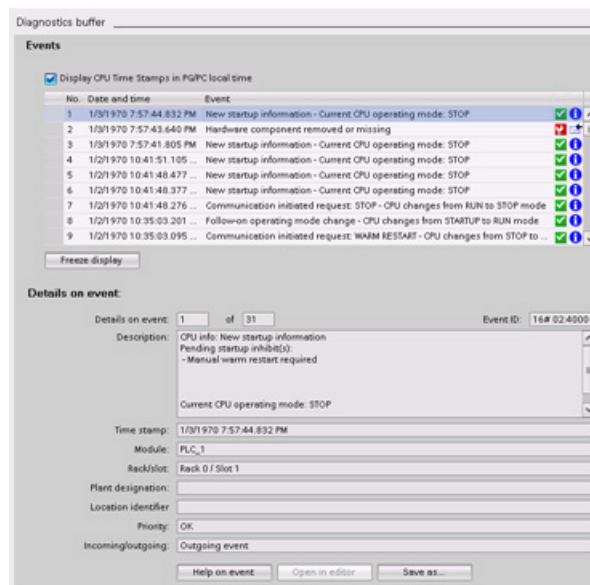

The first entry contains the latest event. Each entry in the diagnostic buffer contains the date and time the event was logged, and a description.

The maximum number of entries is dependent on the CPU. A maximum of 50 entries is supported.

Only the 10 most recent events in the diagnostic buffer are stored permanently. Resetting the CPU to the factory settings resets the diagnostic buffer by deleting the entries.

You can also use the GET_DIAG instruction (Page 358) to collect the diagnostic information.

14.10 Comparing offline and online CPUs

You can compare the code blocks in an online CPU with the code blocks in your project. If the code blocks of your project do not match the code blocks of the online CPU, the "Compare" editor allows you to synchronize your project with the online CPU by downloading the code blocks of your project to the CPU, or by deleting blocks from the project that do not exist in the online CPU.

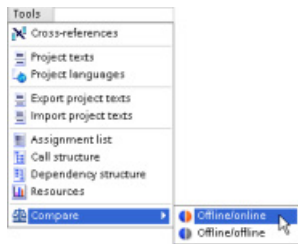

Select the CPU in your project.

Use the "Compare Offline/online" command to open the "Compare" editor. (Access the command either from the "Tools" menu or by right-clicking the CPU in your project.)

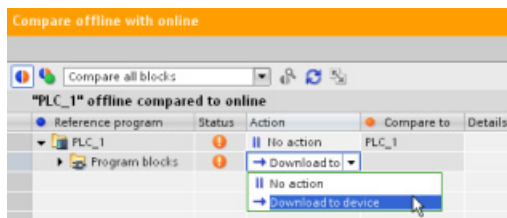

Click in the "Action" column for an object to select whether to delete the object, take no action, or download the object to the device.

Click the "Synchronize" button to load the code blocks.

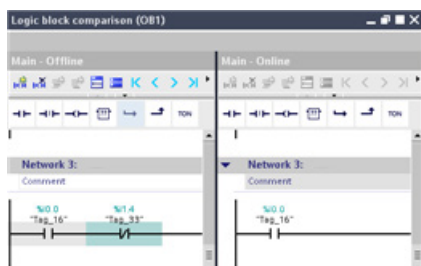

Right-click an object in the "Compare to" column and select "Start detailed comparison" button to show the code blocks side-by-side.

The detailed comparison highlights the differences between the code blocks of online CPU and the code blocks of the CPU in your project.

14.11 Monitoring and modifying values in the CPU

STEP 7 provides online tools for monitoring the CPU:

- You can display or monitor the current values of the tags. The monitoring function does not change the program sequence. It presents you with information about the program sequence and the data of the program in the CPU.
- You can also use other functions to control the sequence and the data of the user program:
 - You can modify the value for the tags in the online CPU to see how the user program responds.
 - You can force a peripheral output (such as Q0.1:P or "Start":P) to a specific value.
 - You can enable outputs in STOP mode.

Note

Always exercise caution when using control functions. These functions can seriously influence the execution of the user/system program.

Table 14- 3 Online capabilities of the STEP 7 editors

| Editor | Monitor | Modify | Force |
|----------------|---------|--------|-------|
| Watch table | Yes | Yes | No |
| Force table | Yes | No | Yes |
| Program editor | Yes | Yes | No |
| Tag table | Yes | No | No |
| DB editor | Yes | No | No |

14.11.1 Going online to monitor the values in the CPU

To monitor the tags, you must have an online connection to the CPU. Simply click the "Go online" button in the toolbar.

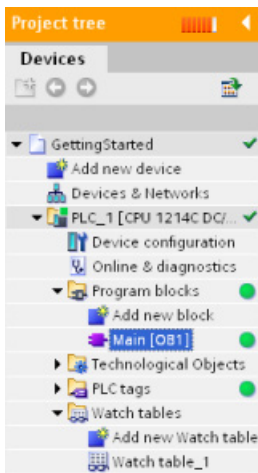
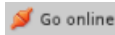

When you have connected to the CPU, STEP 7 turns the headers of the work areas orange.

The project tree displays a comparison of the offline project and the online CPU. A green circle means that the CPU and the project are synchronized, meaning that both have the same configuration and user program.

Tag tables show the tags. Watch tables can also show the tags, as well as direct addresses.

| | Name | Address | Display format | Monitor value | Modify value |
|---|-------|---------|----------------|---------------|--------------|
| 1 | "On" | %I 0 | Bool | | |
| 2 | "Off" | %I 1 | Bool | | |
| 3 | "Run" | %Q 0 | Bool | | |

To monitor the execution of the user program and to display the values of the tags, click the "Monitor all" button in the toolbar.

| | Name | Address | Display format | Monitor value | Modify value |
|---|-------|---------|----------------|--------------------------------|--------------|
| 1 | "On" | %I 0 | Bool | <input type="checkbox"/> FALSE | |
| 2 | "Off" | %I 1 | Bool | <input type="checkbox"/> FALSE | |
| 3 | "Run" | %Q 0 | Bool | <input type="checkbox"/> FALSE | |

The "Monitor value" field shows the value for each tag.

14.11.2 Displaying status in the program editor

You can monitor the status of the tags in the LAD and FBD program editors. Use the editor bar to display the LAD editor. The editor bar allows you to change the view between the open editors without having to open or close the editors.

In the toolbar of the program editor, click the "Monitoring on/off" button to display the status of your user program.



The network in the program editor displays power flow in green.

You can also right-click on the instruction or parameter to modify the value for the instruction.

14.11.3 Capturing the online values of a DB to reset the start values

You can capture the current values being monitored in an online CPU to become the start values for a global DB.

- You must have an online connection to the CPU.
- The CPU must be in RUN mode.
- You must have opened the DB in STEP 7.



Use the "Show a snapshot of the monitored values" button to capture the current values of the selected tags in the DB. You can then copy these values into the "Start value" column of the DB.

1. In the DB editor, click the "Monitor all tags" button. The "Monitor value" column displays the current data values.
2. Click the "Show a snapshot of the monitored values" button to display the current values in the "Snapshot" column.
3. Click the "Monitor all" button to stop monitoring the data in the CPU.
4. Copy a value in the "Snapshot" column for a tag.
 - Select a value to be copied.
 - Right-click the selected value to display the context menu.
 - Select the "Copy" command.
5. Paste the copied value into the corresponding "Start value" column for the tag. (Right-click the cell and select "Paste" from the context menu.)

6. Save the project to configure the copied values as the new start values for the DB.
7. Compile and download the DB to the CPU. The DB uses the new start values after the CPU goes to RUN mode.

Note

The values that are shown in the "Monitor value" column are always copied from the CPU. STEP 7 does not check whether all values come from the same scan cycle of the CPU.

14.11.4 Using a watch table to monitor and modify values in the CPU

A watch table allows you to perform monitoring and control functions on data points as the CPU executes your program. These data points can be process image (I or Q), M, DB or physical inputs (I_:P), depending on the monitor or control function. You cannot accurately monitor the physical outputs (Q_:P) because the monitor function can only display the last value written from Q memory and does not read the actual value from the physical outputs.

The monitoring function does not change the program sequence. It presents you with information about the program sequence and the data of the program in the CPU.

Control functions enable the user to control the sequence and the data of the program. You must exercise caution when using control functions. These functions can seriously influence the execution of the user/system program. The three control functions are Modify, Force and Enable Outputs in STOP.

With the watch table, you can perform the following online functions:

- Monitoring the status of the tags
- Modifying values for the individual tags

You select when to monitor or modify the tag:

- Beginning of scan cycle: Reads or writes the value at the beginning of the scan cycle
- End of scan cycle: Reads or writes the value at the end of the scan cycle
- Switch to stop

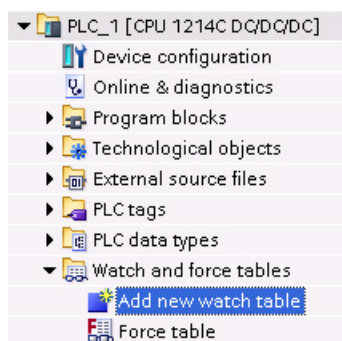

To create a watch table:

1. Double-click "Add new watch table" to open a new watch table.
2. Enter the tag name to add a tag to the watch table.

The following options are available for monitoring tags:

- Monitor all: This command starts the monitoring of the visible tags in the active watch table.
- Monitor now: This command starts the monitoring of the visible tags in the active watch table. The watch table monitors the tags immediately and once only.

The following options are available for modifying tags:

- "Modify to 0" sets the value of a selected address to "0".
- "Modify to 1" sets the value of a selected address to "1".
- "Modify now" immediately changes the value for the selected addresses for one scan cycle.
- "Modify with trigger" changes the values for the selected addresses.
This function does not provide feedback to indicate that the selected addresses were actually modified. If feedback of the change is required, use the "Modify now" function.
- "Enable peripheral outputs" disables the command output disable and is available only when the CPU is in STOP mode.

To monitor the tags, you must have an online connection to the CPU.

| | Name | Address | Display format | Monitor value | Monitor with trigger | Modify with trigger | Modify value |
|---|-----------|---------|----------------|---------------|----------------------|---------------------|--------------|
| 1 | "Start" | %I0.0 | Bool | | Permanent | Permanent | |
| 2 | "Stop" | %I0.1 | Bool | | Permanent | Permanent | |
| 3 | "Running" | %M0.0 | Bool | | Permanent | Permanent | |

You use the buttons at the top of the watch table to select the various functions.

Enter the tag name to monitor and select a display format from the dropdown selection. With an online connection to the CPU, click the "Monitor" button to display the actual value of the data point in the "Monitor value" field.

14.11.4.1 Using a trigger when monitoring or modifying PLC tags

Triggering determines at what point in the scan cycle the selected address will be monitored or modified.

Table 14- 4 Types of triggers

| Trigger | Description |
|-----------------------|---|
| Permanent | Continuously collects the data |
| At scan cycle start | Permanent: Continuously collects the data at the start of the scan cycle, after the CPU reads the inputs |
| | Once: Collects the data at the start of the scan cycle, after the CPU reads the inputs |
| At scan cycle end | Permanent: Continuously collects the data at the end of the scan cycle, before the CPU writes the outputs |
| | Once: Collects the data once at the end of the scan cycle, before the CPU writes the outputs |
| At transition to STOP | Permanent: Continuously collects data when the CPU transitions to STOP |
| | Once: Collects the data once after the CPU transitions to STOP |

For modifying a PLC tag at a given trigger, select either the start or the end of cycle.

- Modifying an output: The best trigger event for modifying an output is at the end of the scan cycle, immediately before the CPU writes the outputs.

Monitor the value of the outputs at the beginning of the scan cycle to determine what value is written to the physical outputs. Also, monitor the outputs before the CPU writes the values to the physical outputs in order to check program logic and to compare to the actual I/O behavior.

- Modifying an input: The best trigger event for modifying an input is at the start of the cycle, immediately after the CPU reads the inputs and before the user program uses the input values.

If you suspect values are changing during the scan, you might want to monitor the value of the inputs at the end of the scan cycle to ensure that the value of the input at the end of the scan cycle has not changed from the start of the scan cycle. If there is a difference in the values, your user program might be erroneously writing to inputs.

To diagnose why the CPU might have gone to STOP, use the "Transition to STOP" trigger to capture the last process values.

14.11.4.2 Enabling outputs in STOP mode

The watch table allows you to write to the outputs when the CPU is in STOP mode. This functionality allows you to check the wiring of the outputs and verify that the wire connected to an output pin initiates a high or low signal to the terminal of the process device to which it is connected.

WARNING

Risks in writing to physical outputs in STOP mode

Even though the CPU is in STOP mode, enabling a physical output can activate the process point to which it is connected, possibly resulting in unexpected equipment operation. Unexpected equipment operation can cause death or severe personal injury.

Before writing to an output from the watch table, ensure that changing the physical output cannot cause unexpected equipment operation. Always observe safety precautions for your process equipment.

You can change the state of the outputs in STOP mode when the outputs are enabled. If the outputs are disabled, you cannot modify the outputs in STOP mode. To enable the modification in STOP mode of the outputs from the watch table, follow these steps:

1. Select the "Expanded mode" menu command from the "Online" menu.
2. Select the "Enable peripheral outputs" option of the "Modify" command of the "Online" menu, or from the context menu after right-clicking the row of the Watch table.

You cannot enable outputs in STOP mode if you have configured distributed I/O. An error is returned when you try to do this.

Setting the CPU to RUN mode disables "Enable peripheral outputs" option.

If any inputs or outputs are forced, the CPU is not allowed to enable outputs while in STOP mode. The force function must first be cancelled.

14.11.5 Forcing values in the CPU

14.11.5.1 Using the force table

A force table provides a "force" function that overwrites the value for an input or output point to a specified value for the peripheral input or peripheral output address. The CPU applies this forced value to the input process image prior to the execution of the user program and to the output process image before the outputs are written to the modules.

Note

The force values are stored in the CPU and not in the force table.

You cannot force an input (or "I" address) or an output (or "Q" address). However, you can force a peripheral input or peripheral output. The force table automatically appends a ":P" to the address (for example: "On":P or "Run":P).

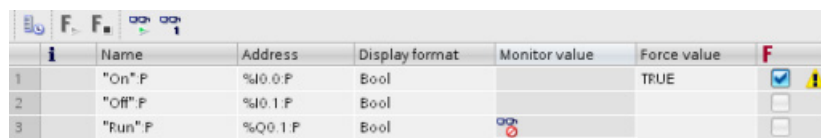

| | i | Name | Address | Display format | Monitor value | Force value | F |
|---|---|---------|---------|----------------|---------------|-------------|---------------------------------------|
| 1 | | "On" P | %I0.0 P | Bool | | TRUE | <input checked="" type="checkbox"/> ⚠ |
| 2 | | "Off" P | %I0.1 P | Bool | | | <input type="checkbox"/> |
| 3 | | "Run" P | %Q0.1 P | Bool | | | <input type="checkbox"/> |

In the "Force value" cell, enter the value for the input or output to be forced. You can then use the check box in the "Force" column to enable forcing of the input or output.



Use the "Start or replace forcing" button to force the value of the tags in the force table. Click the "Stop forcing" button to reset the value of the tags.

In the force table, you can monitor the status of the forced value for an input. However, you cannot monitor the forced value of an output.

You can also view the status of the forced value in the program editor.

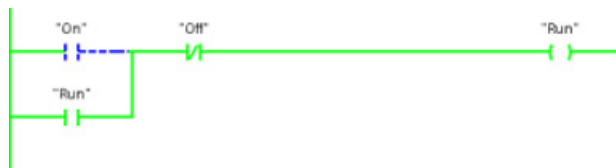

Note

When an input or output is forced in a force table, the force actions become part of the project configuration. If you close STEP 7, the forced elements remain active in the CPU program until they are cleared. To clear these forced elements, you must use STEP 7 to connect with the online CPU and then use the force table to turn off or stop the force function for those elements.

14.11.5.2 Operation of the Force function

The CPU allows you to force input and output point(s) by specifying the physical input or output address (I_:P or Q_:P) in the force table and then starting the force function.

In the program, reads of physical inputs are overwritten by the forced value. The program uses the forced value in processing. When the program writes a physical output, the output value is overwritten by the force value. The forced value appears at the physical output and is used by the process.

When an input or output is forced in the force table, the force actions become part of the user program. Even though the programming software has been closed, the force selections remain active in the operating CPU program until they are cleared by going online with the programming software and stopping the force function. Programs with forced points loaded on another CPU from a memory card will continue to force the points selected in the program.

If the CPU is executing the user program from a write-protected memory card, you cannot initiate or change the forcing of I/O from a watch table because you cannot override the values in the write-protected user program. Any attempt to force the write-protected values generates an error. If you use a memory card to transfer a user program, any forced elements on that memory card will be transferred to the CPU.

Note

Digital I/O points assigned to HSC, PWM, and PTO cannot be forced

The digital I/O points used by the high-speed counter (HSC), pulse-width modulation (PWM), and pulse-train output (PTO) devices are assigned during device configuration. When digital I/O point addresses are assigned to these devices, the values of the assigned I/O point addresses cannot be modified by the force function of the force table.

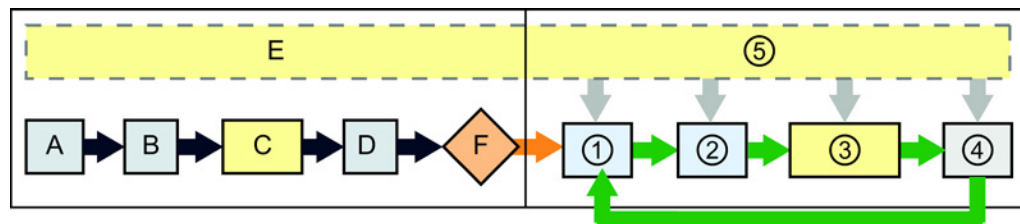

Startup

- A The clearing of the I memory area is not affected by the Force function.
- B The initialization of the outputs values is not affected by the Force function.
- C During the execution of the startup OBs, the CPU applies the force value when the user program accesses the physical input.
- D The storing of interrupt events into the queue is not affected.
- E The enabling of the writing to the outputs is not affected.

RUN

- ① While writing Q memory to the physical outputs, the CPU applies the force value as the outputs are updated.
- ② When reading the physical inputs, the CPU applies the force values just prior to copying the inputs into I memory.
- ③ During the execution of the user program (program cycle OBs), the CPU applies the force value when the user program accesses the physical input or writes the physical output.
- ④ Handling of communication requests and self-test diagnostics are not affected by the Force function.
- ⑤ The processing of interrupts during any part of the scan cycle is not affected.

14.12 Downloading in RUN mode

The CPU supports "Download in RUN mode". This capability is intended to allow you to make small changes to a user program with minimal disturbance to the process being controlled by the program. However, implementing this capability also allows massive program changes that could be disruptive or even dangerous.

WARNING

Risks with downloading in RUN mode

When you download changes to the CPU in RUN mode, the changes immediately affect process operation. Changing the program in RUN mode can result in unexpected system operation, which could cause death or serious injury to personnel, and/or damage to equipment.

Only authorized personnel who understand the effects of RUN mode changes on system operation should perform a download in RUN mode.

The "Download in RUN mode" feature allows you to make changes to a program and download them to your CPU without switching to STOP mode:

- You can make minor changes to your current process without having to shut down (for example, change a parameter value).
- You can debug a program more quickly with this feature (for example, invert the logic for a normally open or normally closed switch).

You can make the following program block and tag changes and download them in RUN mode:

- Create, overwrite, and delete Functions (FC), Function Blocks (FB), and Tag tables.
- Create, delete, and overwrite Data Blocks (DB) and instance data blocks for Function Blocks (FB). You can add to DB structures and download them in RUN mode. The CPU can maintain the values of existing block tags and initialize the new data block tags to their initial values, or the CPU can set all data block tags to initial values, depending on your configuration settings (Page 808). You cannot download a web server DB (control or fragment) in RUN mode.
- Overwrite Organization Blocks (OB); however, you cannot create or delete OBs.

You can download a maximum number of twenty blocks in RUN mode at one time. If you must download more than twenty blocks, you must place the CPU in STOP mode.

If you download changes to a real process (as opposed to a simulated process, which you might do in the course of debugging a program), it is vital to think through the possible safety consequences to machines and machine operators before you download.

Note

If the CPU is in RUN mode and program changes have been made, STEP 7 always tries to download in RUN first. If you do not want this to happen, you must put the CPU into STOP.

If the changes made are not supported in "Download in RUN", STEP 7 prompts the user that the CPU must go to STOP.

14.12.1 Prerequisites for "Download in RUN mode"

To be able to download your program changes to a CPU that is in RUN mode, you must meet these prerequisites:

- Your CPU version is V3.0 or later

Note

Your CPU version must be V4.0 or later to modify existing blocks and download the extended block interface in RUN mode. (Page 808)

- Your program must compile successfully.
- You must have successfully established communication between the programming device where you are running STEP 7 and the CPU.

14.12.2 Changing your program in RUN mode

To change the program in RUN mode, you must first ensure that the CPU and program meet the prerequisites (Page 804), and then follow these steps:

1. To download your program in RUN mode, select one of the following methods:
 - Select the "Download to device" command from the "Online" menu.
 - Click the "Download to device" button in the toolbar.
 - In the "Project tree", right-click "Program blocks" and select the "Download to device > Software" command.

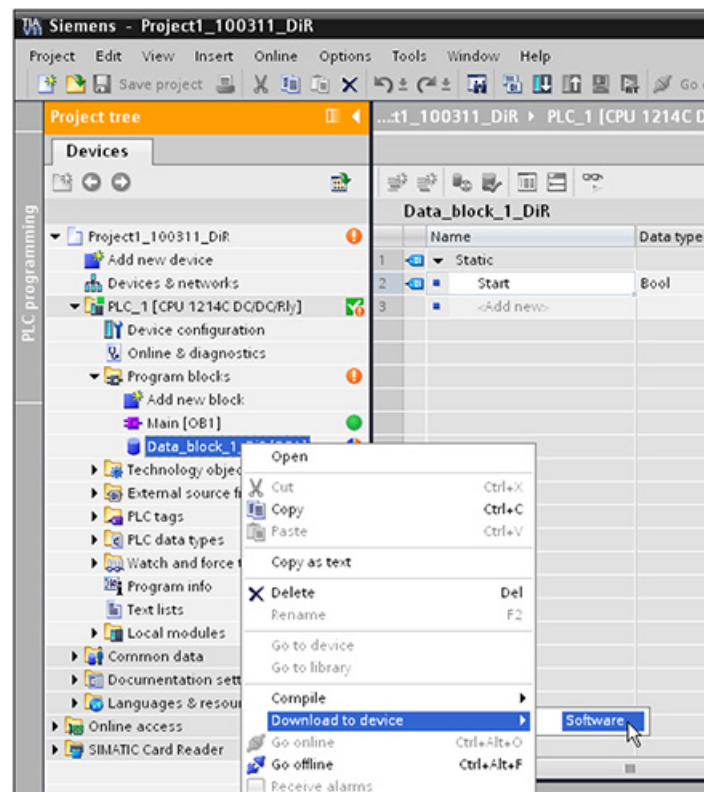

If the program compiles successfully, STEP 7 starts to download the program to the CPU.

2. When STEP 7 prompts you to load your program or cancel the operation, click "Load" to download the program to the CPU.

14.12.3 Downloading selected blocks

From the Program blocks folder, you can select a single block or a selection of blocks for download.

If you select a single block for downloading, then the only option in the "Action" column is "Consistent download". You can expand the category line to be sure what blocks are to be loaded. In this example, a small change was made to the offline block, and no other blocks need to be loaded.

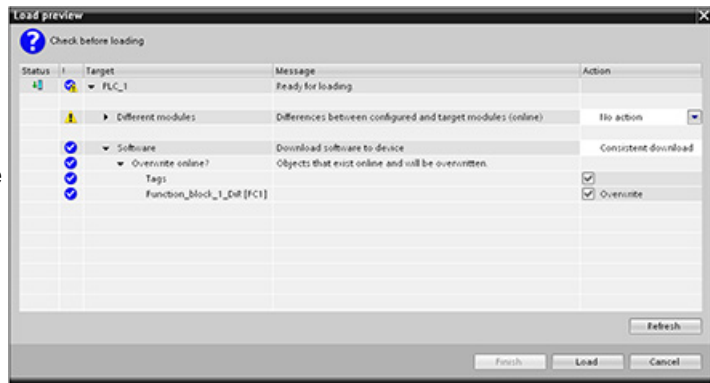

In this example, more than one block is needed for downloading.

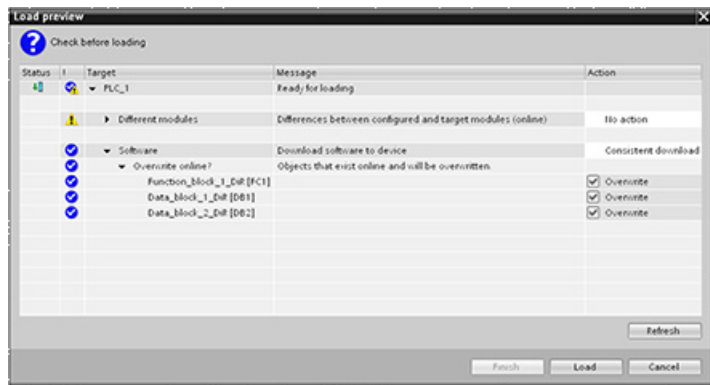

Note

You can download a maximum number of twenty blocks in RUN mode at one time. If you must download more than twenty blocks, you must place the CPU in STOP mode.

If you attempt to download in RUN, but the system detects that this is not possible prior to the actual download, then the Stop modules category line appears in the dialog.

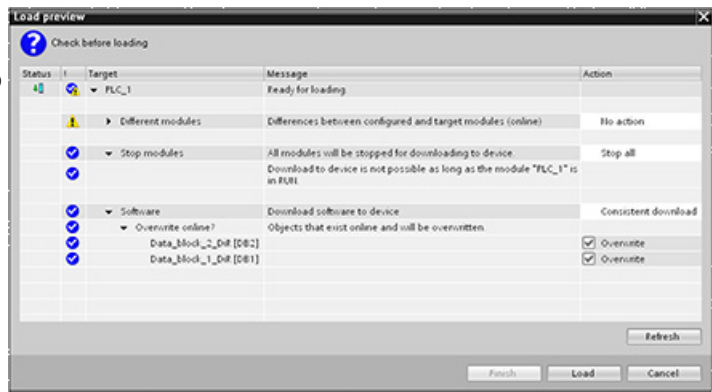

Click the "Load" button, and the "Load results" dialog appears. Click the "Finish" button to complete the download.

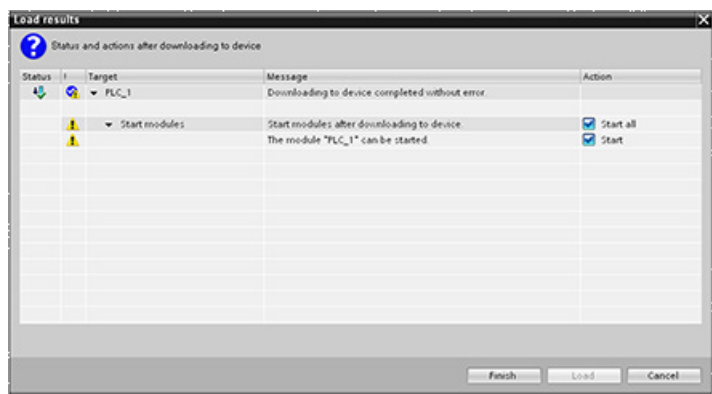

14.12.4 Downloading a single selected block with a compile error in another block

If you attempt a consistent download with a compile error in another block, then the dialog indicates an error, and the load button is disabled.

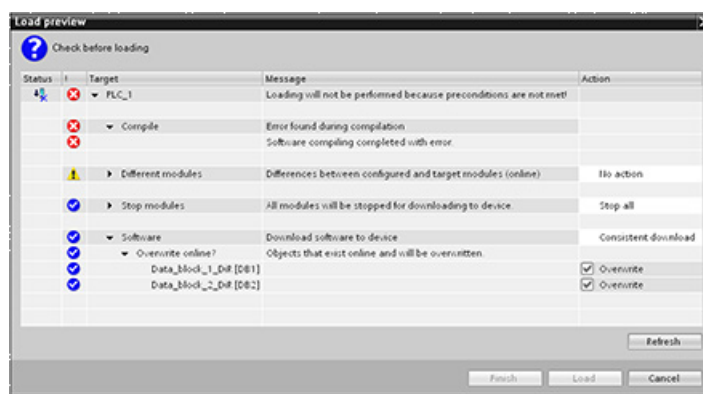

You must correct the compile error in the other block. Then, the "Load" button becomes active.



14.12.5 Modifying and downloading existing blocks in RUN mode

The Download in Run feature allows you to add and modify tags in data blocks and function blocks and then download the changed block to the CPU in RUN mode.

Download without reinitialization

Each DB and FB has an amount of reserved memory, which you can use for adding tags to the block that you can subsequently download in RUN mode. By default, the initial size of the memory reserve is 100 bytes. You can add additional tags to your data up to the size of the memory reserve and download the extended block to the CPU in RUN mode. You can also increase the memory reserve if you need more memory for additional tags in your block. If you add more tags than the amount of memory you have allocated, you cannot download the extended block to the CPU in RUN mode.

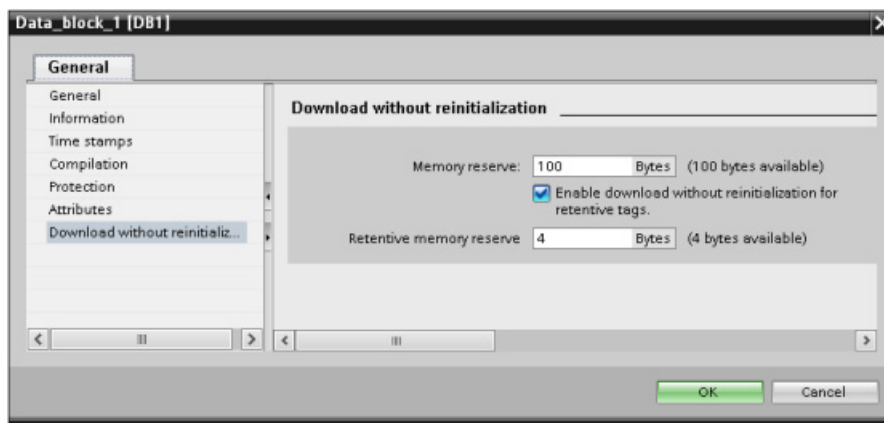

The "Download without reinitialization" feature allows you to extend a data block by adding more data block tags and download the extended data block in RUN mode. In this way, you can add tags to a data block and download it without reinitializing your program. The CPU retains the values of the existing data block tags and initializes the newly-added tags to their start values.

To enable this function for an online project with a CPU in RUN mode, follow these steps:

1. From the Program blocks folder in the STEP 7 project tree, open the block.
2. Click the "Download without reinitialization" toggle button in the block editor to enable the function. (The icon has a box around it when you have enabled it: )
3. Click OK on the prompt to confirm your choice.
4. Add tags to the block interface and download the block in RUN mode. You can add and download as many new tags as your memory reserve allows.

If you have added more bytes to your block than you have configured for the memory reserve, STEP 7 displays an error when you attempt to download the block in RUN mode. You must edit the block properties to increase the amount. You cannot delete existing entries or modify the "Memory reserve" of the block while the "Download without reinitialization" function is enabled. To disable the "Download without reinitialization" function, follow these steps:

1. Click the "Download without reinitialization" toggle button in the block editor to disable the function. (The icon does not have a box around it when you have disabled it: )
2. Click OK on the prompt to confirm your choice.
3. Download the block. On the download dialog, you must select "reinitialize" in order to download the extended block.

The download then reinitializes all existing and new block tags to their start values.

Downloading retentive block tags

Downloading retentive block tags in RUN mode requires the allocation of a retentive memory reserve. To configure this retentive memory reserve, follow these steps:

1. From the Program blocks folder in the STEP 7 project tree, right-click the block and select "Properties" from the context menu.
2. Select the "Download without reinitialization" property.
3. Select the check box for "Enable download without reinitialization for retentive tags".
4. Configure the number of bytes available for the retentive memory reserve.
5. Click OK to save your changes.
6. Add retentive data block tags to the data block and download the data block in RUN mode. You can add and download as many new retentive data block tags as your retentive memory reserve allows.

If you have added more retentive bytes to your data block than you have configured for the retentive memory reserve, STEP 7 displays an error when you attempt to download the block in RUN mode. You can only add retentive block tags up to the retentive memory reserve in order to be able to download them in RUN mode.

When you download the extended retentive block tags, the tags contain their current values.

Configuring amount of reserved memory for new blocks

The default memory reserve size for new data blocks is 100 bytes. When you create a new block, it has 100 bytes available in reserve. If you want the memory reserve size to be different for new blocks, you can change the setting in the PLC programming settings:

1. From STEP 7, select the **Options > Settings** menu command.
2. From the Settings dialog, expand "PLC programming" and select "General".
3. In the "Download without reinitialization" section, enter the number of bytes for the memory reserve.

When you create new blocks, STEP 7 uses the memory reserve configuration that you entered for the new blocks.

Restrictions

The following restrictions apply to editing and downloading blocks in RUN mode:

- Extending the block interface by adding new tags and downloading in RUN mode is only available for optimized blocks (Page 176).
- You cannot change the structure of a block and download the changed block in RUN mode without reinitializing. Adding new members to a Struct (Page 117) tag, changing tag names, array sizes, data types, or retentive status all require that you reinitialize the block if you download it in RUN mode. The only modifications to existing block tags that you can perform and still download the block in RUN mode without reinitialization are changes to start values (data blocks), default values (function blocks) or comments.

Note

The ability to modify blocks and download them in RUN mode is new with V4.0 of the S7-1200 CPU. Prior to V4.0, you could only download modified blocks in STOP mode.

- You cannot download more new block tags in RUN mode than the memory reserve can accommodate.
- You cannot download more new retentive block tags in RUN mode than the retentive memory reserve can accommodate.

See also

Exchanging a V3.0 CPU for a V4.0 CPU (Page 995)

14.12.6 System reaction if the download process fails

During the initial Download in RUN operation, if a network connection failure occurs, STEP 7 displays the following "Load preview" dialog:

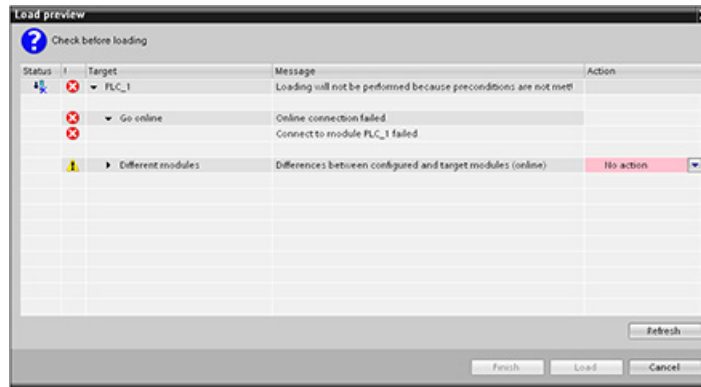

14.12.7 Considerations when downloading in RUN mode

Before downloading the program in RUN mode, consider the effect of a RUN-mode modification on the operation of the CPU for the following situations:

- If you deleted the control logic for an output, the CPU maintains the last state of the output until the next power cycle or transition to STOP mode.
- If you deleted a high-speed counter or pulse output functions which were running, the high-speed counter or pulse output continues to run until the next power cycle or transition to STOP mode.
- Any logic that is conditional on the state of the first scan bit will not be executed until the next power cycle or transition from STOP to RUN mode. The first scan bit is set only by the transition to RUN mode and is not affected by a download in RUN mode.
- The current values of data blocks (DB) and/or tags can be overwritten.

Note

Before you can download your program in RUN mode, the CPU must support changes in RUN mode, the program must compile with no errors, and the communication between STEP 7, and the CPU must be error-free.

You can make the following changes in program blocks and tags and download them in RUN mode:

- Create, overwrite, and delete Functions (FC), Function Blocks (FB), and Tag tables.
- Create and delete Data Blocks (DB); however, DB structure changes cannot be overwritten. Initial DB values can be overwritten. You cannot download a web server DB (control or fragment) in RUN mode.
- Overwrite Organization Blocks (OB); however, you cannot create or delete OBs.

You can download a maximum number of twenty blocks in RUN mode at one time. If you must download more than twenty blocks, you must place the CPU in STOP mode.

Once you initiate a download, you cannot perform other tasks in STEP 7 until the download completes.

Instructions that might fail due to "Download in RUN mode"

The following instructions might experience a temporary error when download in run changes are being activated in the CPU. The error occurs when the instruction is initiated while the CPU is preparing to activate the downloaded changes. During this time, the CPU suspends initiation of user-program access to the Load Memory, while it completes in-progress user-program access to Load Memory. This is done so that downloaded changes can be activated consistently.

| Instruction | Response while Activation is Pending |
|----------------|--------------------------------------|
| DataLogCreate | STATUS = W#16#80C0, ERROR = TRUE |
| DataLogOpen | STATUS = W#16#80C0, ERROR = TRUE |
| DataLogWrite | STATUS = W#16#80C0, ERROR = TRUE |
| DataLogClose | STATUS = W#16#80C0, ERROR = TRUE |
| DataLogNewFile | STATUS = W#16#80C0, ERROR = TRUE |
| READ_DBL | RET_VAL = W#16#82C0 |
| WRIT_DBL | RET_VAL = W#16#82C0 |
| RTM | RET_VAL = 0x80C0 |

In all cases the RLO output from the instruction will be false when the error occurs. The error is temporary. If it occurs, the instruction should be retried later.

Note

You must not retry the operation in the current execution of the OB.

14.13 Tracing and recording CPU data on trigger conditions

STEP 7 provides trace and logic analyzer functions with which you can configure variables for the PLC to trace and record. You can then upload the recorded trace data to your programming device and use STEP 7 tools to analyze, manage, and graph your data. You use the Traces folder in the STEP 7 project tree to create and manage traces.

The following figure shows the various steps of the trace feature:

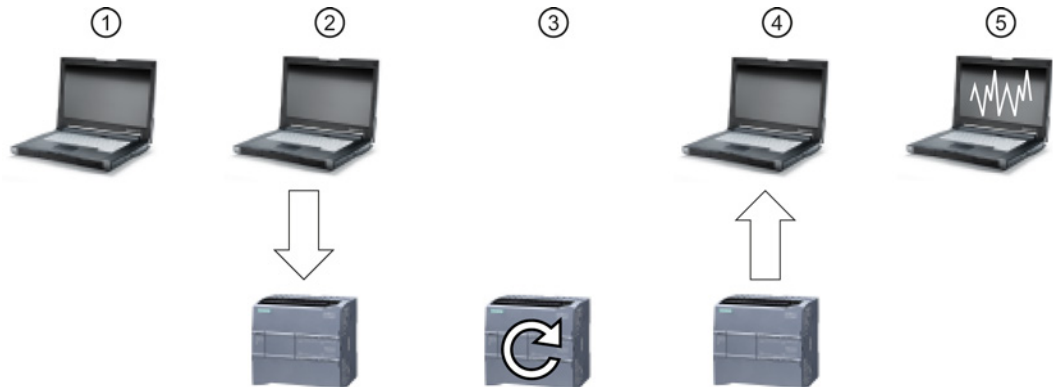

- ① Configure the trace in the trace editor of STEP 7. You can configure the data values to record, the recording duration, the recording frequency, and the trigger condition.
- ② Transfer the trace configuration from STEP 7 to the PLC.
- ③ The PLC executes the program, and when the trigger condition occurs, begins recording the trace data.
- ④ Transfer the recorded values from the PLC to STEP 7.
- ⑤ Use the tools in STEP 7 to analyze the data, display it graphically, and save it.

Note that the trace feature is only available as of V4.0 of the S7-1200 CPU.

See the STEP 7 information system for details about how to program a trace, how to download the configuration, upload the trace data, and display the data in the logic analyzer.

SM 1278 4xIO-Link Master

15.1 SM 1278 4xIO-Link Master overview

15.1.1 Overview

The SM 1278 4xIO-Link Master is a 4-port module that functions as both a signal module and a communication module. Each port can operate in the IO-Link mode, single 24 VDC digital input or 24 VDC digital output.

15.1.2 IO-Link and your STEP 7 program

The IO-Link master programs acyclic communication with an IO-Link device using the IOL_CALL function block (FB) in your STEP 7 S7-1200 controller program. The IOL_CALL FB indicates the IO-Link master your program uses, and which ports the master uses for data exchange.

Visit the Siemens Industry Online Support website (<http://support.automation.siemens.com>) for details on working with the IOL_CALL FB. Enter "IO-Link" in the website's search box to access information about IO-Link products and their use.

15.1.3 Properties

View of the module

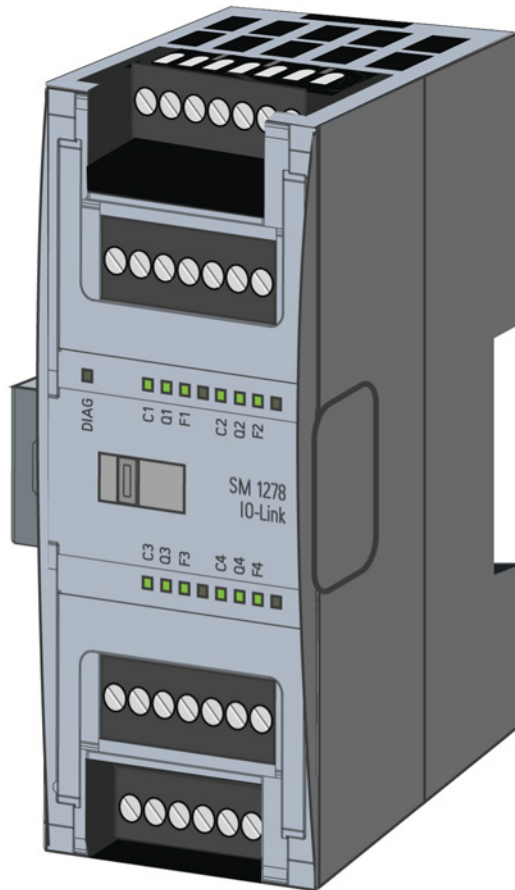

Properties

Technical properties

- IO-Link Master according to IO-Link specification V1.1 (see the IO-Link Consortium website (<http://io-link.com/en/index.php>) for details)
- Serial communication module with four ports (channels)
- Data transmission rate COM1 (4.8 kbaud), COM2 (38.4 kbaud), COM3 (230.4 kbaud)
- SIO mode (standard IO mode)
- Connection of up to four IO-Link devices (3-wire connection) or four standard actuators or standard encoders
- Programmable diagnostics function by port

Supported functions

- I&M (installation and maintenance) identification data
- Firmware update
- IO-Link parameter assignment by means of the S7-PCT port configuration tool, STEP 7 Professional, and an S7-1200 V4.0 or higher CPU

15.1.4 Functions

IO-Link is a point-to-point connection between a master and a device. Both conventional and intelligent sensors/actuators can be used as devices at the IO-Link via unshielded standard cables using proven 3-wire technology. IO-Link is backward compatible with conventional digital sensors and actuators. The circuit state and data channel are designed in proven 24 VDC technology.

For additional information about the SIMATIC IO-Link technology, refer to the "IO-Link system Function Manual" on the Siemens Industry Online Support website (<http://support.automation.siemens.com>).

15.1.5 Replacing the SM 4xIO-Link signal module**Note****IO-Link parameter data**

When you replace the SM 4xIO-Link Master, the parameter data is not automatically assigned to it.

 CAUTION**Removal and insertion**

If you insert the SM 4xIO-Link Master with the load switched on, this can lead to dangerous conditions in your plant.

Physical damage to the S7-1200 automation system may occur as a result.

Remove or insert the SM 4xIO-Link Master only when the load is switched off.

15.1.6 Reset module to factory settings

Effects of resetting to the factory settings

Use the function "Reset to factory settings" to restore the parameter assignments you made with S7-PCT to the delivery state.

After a "Reset to factory settings", the parameters of the SM 1278 4xIO-Link module are assigned as follows:

- The ports are in DI mode
- The ports are mapped to the relative addresses 0.0 to 0.3
- The PortQualifier is disabled
- Maintenance data 1 to 3 is deleted

Note

When you reset to factory settings, the device parameters are deleted and the delivery state is restored.

If you remove an SM 1278 4xIO-Link signal module, reset it to factory settings before you put it into storage.

Procedure

For "Reset to factory settings", proceed as described in the S7-PCT online help under "Master Configuration > 'Commands' tab".

15.2 Connecting

15.2.1 Pin assignment

For details about pin assignment, see the "IO-Link Master signal module" technical specification in Appendix A (Page 934).

The following table shows the terminal assignments for the SM 1278 4xIO-Link Master:

| Pin | X10 | X11 | X12 | X13 | Notes | BaseUnits |
|-----|---|------------------|------------------|------------------|--|-----------|
| 7 | M ₁ | M ₂ | M ₃ | M ₄ | <ul style="list-style-type: none"> M_n: ground to slave C/Q_n: SDLC, DI or DQ L_n: 24 VDC to slave M: ground L+: 24 VDC to Master RES: reserved; may not be assigned | A1 |
| 6 | C/Q ₁ | C/Q ₂ | C/Q ₃ | C/Q ₄ | | |
| 5 | L ₁ | L ₂ | L ₃ | L ₄ | | |
| 4 | RES | RES | RES | RES | | |
| 3 |  (functional earth) | RES | RES | RES | | |
| 2 | M | RES | RES | RES | | |
| 1 | L+ | RES | RES | RES | | |

The following table contains illustrations of connection examples, where n = port number:

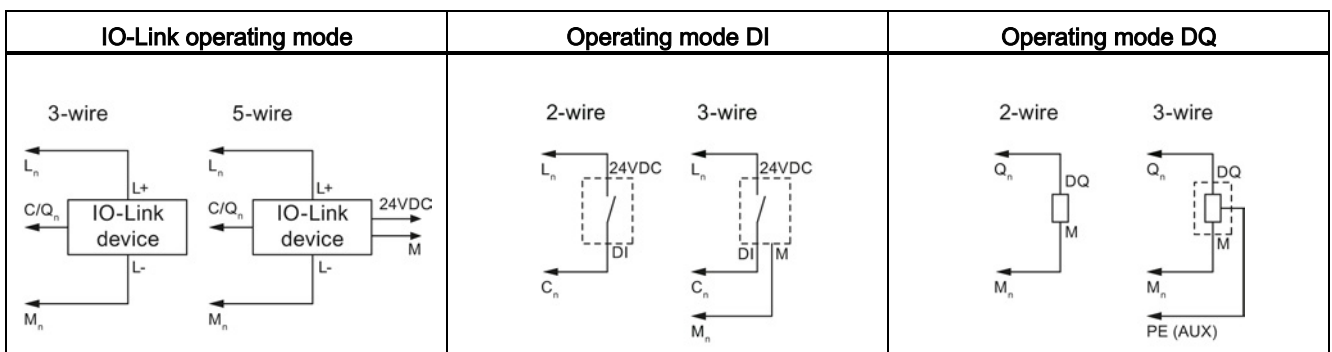

Note

Connected sensors must use the device supply provided by the Master module L_n connection.

15.2.2 Block diagram

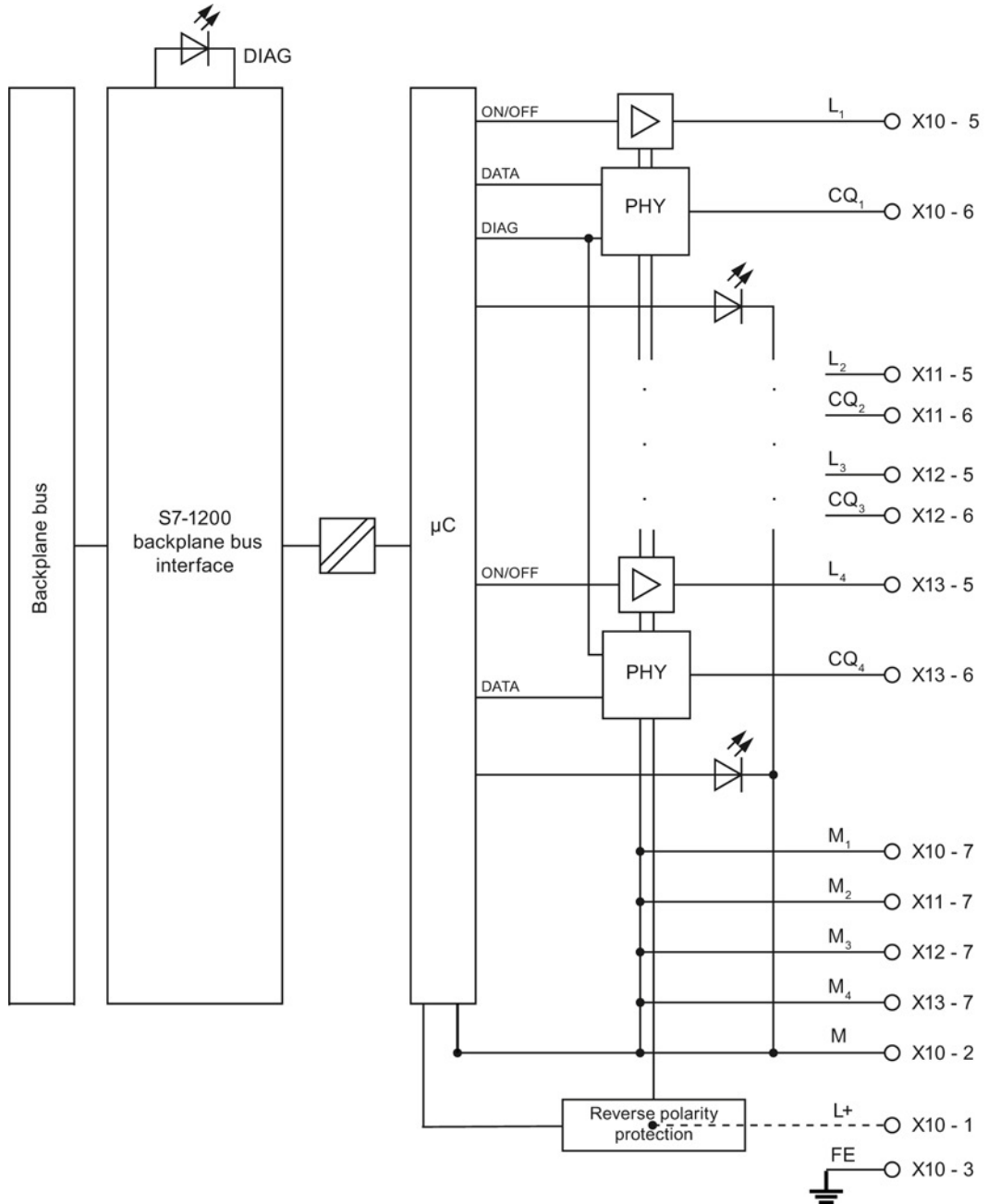

15.3 Parameters/address space

15.3.1 Configuration

Configuring the SM 1278 4xIO-Link Master

For the module integration, you need the Siemens engineering tool TIA Portal V12 or higher. You also need S7-PCT V3.2 or higher for the IO-Link integration.

For commissioning, you require both an engineering tool and S7-PCT V3.2 or higher for parameter assignment.

15.3.2 Parameters

The following table shows the parameters for the SM 1278 4xIO-Link Master:

| Parameters | Value range | Default | Configuration in RUN | Efficiency range |
|--------------------|--|---------|----------------------|------------------|
| Diagnostics port 1 | <ul style="list-style-type: none">• Disable• Enable | Disable | Yes | Port (channel) |
| Diagnostics port 2 | <ul style="list-style-type: none">• Disable• Enable | Disable | Yes | Port (channel) |
| Diagnostics port 3 | <ul style="list-style-type: none">• Disable• Enable | Disable | Yes | Port (channel) |
| Diagnostics port 4 | <ul style="list-style-type: none">• Disable• Enable | Disable | Yes | Port (channel) |

Enable diagnostics for port 1 to port 4 parameter

This parameter allows diagnostics to be enabled for specific ports of the four IO-Link ports.

The port assignments are as follows:

Port 1 → channel 1

Port 2 → channel 2

Port 3 → channel 3

Port 4 → channel 4

15.3.3 Address space

The maximum size of the input and output addresses of the SM 4xIO-Link Master is 32 bytes in each case. You assign address spaces using the S7-PCT port configuration tool.

15.3.4 Parameter data record

Parameter assignment in the user program

You can configure the device in runtime.

Changing parameters in runtime

The module parameters are included in data record 128. You can transmit the modifiable parameters to the module with the WRREC instruction.

When you reset (power cycle) the CPU, the CPU overwrites the parameters that were sent to the module by the WRREC instruction during the parameterization process.

Instruction for parameter assignment

The following instruction is provided for assigning parameters to the I/O module in the user program:

| Instruction | Application |
|--------------|---|
| SFB 53 WRREC | Transfer of the alterable parameters to the module. |

Error message

The following return value is reported in the event of an error:

| Error code | Meaning |
|------------|-----------------------------|
| 80B1H | Error in data length |
| 80E0H | Error in header information |
| 80E1H | Parameter error |

Data record structure

The following table shows the IO-Link parameters:

| Offset | Label | Type | Default | Description |
|--------------------------|---------------------------------|--------|---------|---|
| 0 | Version | 1 byte | 0x02 | Shows the structure of the record 0x02 for the IO-Link Master in accordance with IO-Link V1.1 |
| 1 | Parameter length | 1 byte | 0x02 | Parameter length (2 bytes + 2 headers) |
| IO-Link start parameters | | | | |
| 2 | Port diagnostics (Port1 1 to n) | 1 byte | 0x00 | Activating the diagnostics for port 1 to n |
| 3 | IOL properties | 1 byte | 0x00 | Module properties |

The following table shows the data record version:

| Bit 7 | Bit 6 | Bit 5 | Bit 4 | Bit 3 | Bit 2 | Bit 1 | Bit 0 |
|----------|-------|--------------------|-------|----------------------|-------|-------|-------|
| Reserved | | Major version (00) | | Minor version (0010) | | | |

The following table shows the data record port diagnostics:

| Bit 7 | Bit 6 | Bit 5 | Bit 4 | Bit 3 | Bit 2 | Bit 1 | Bit 0 |
|----------|-------|-------|-------|----------|----------|----------|----------|
| Reserved | | | | EN_Port4 | EN_Port3 | EN_Port2 | EN_Port1 |

EN_Portx:

0 = Diagnostics deactivated

1 = Diagnostics activated

The following table shows the data record IOL properties:

| Bit 7 | Bit 6 | Bit 5 | Bit 4 | Bit 3 | Bit 2 | Bit 1 | Bit 0 |
|----------|-------|-------|-------|-------|-------|-------|-------|
| Reserved | | | | | | | |

15.4 Interrupt, error, and system alarms

15.4.1 Status and error display



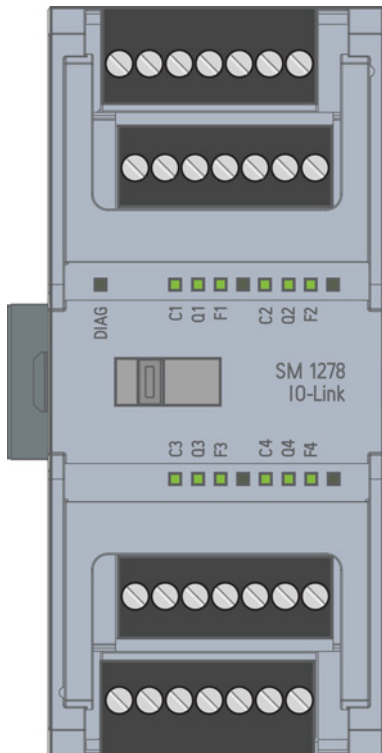

LED display



Meaning of the LED displays



The following table explains the meaning of the status and error displays. You can find remedial measures for diagnostic alarms in the "Diagnostic alarms" section.

LED DIAG

| DIAG | Meaning |
|--|---|
|  Off | Backplane bus supply of the S7-1200 not OK |
|  Flashes | Module is not configured |
|  On | Module parameterized and no module diagnostics |
|  Flashes | Module parameterized and module diagnostics OR L+ power not connected |



LED port status

Valid for IO-Link port which is in IO-Link port mode.



| COM/1 ... COM/4 | Meaning |
|--|---|
|  Off | Port deactivated |
|  Flashes | Port activated, device not connected or Port is not connected to the configured device |
|  On | Port activated, device connected |

LED channel status

Valid for IO-Link port which is in DI/Q mode.

| DI/Q1 ... DI/Q4 | Meaning |
|--|--------------------|
|  Off | Process signal = 0 |
|  On | Process signal = 1 |

LED port error

| F1 ... F4 | Meaning |
|--|----------|
|  Off | No error |
|  On | Error |

15.4.2 Diagnostic alarms

Module errors are indicated as diagnostics (module status) only in IO-Link mode.

| Diagnostic alarm | Error code (decimal) | STATUS (W#16#. ..) | Meaning (IO-Link error code) | IO-Link master | IO-Link device |
|----------------------------|----------------------|----------------------|--|----------------|----------------|
| Short-circuit | 1 | 1804 | Short-circuit at the process cables on the IO-Link device | X | |
| | | 7710 | Short-circuit on IO device | | X |
| Undervoltage | 2 | 5111 5112 | Supply voltage too low | | X |
| Overvoltage | 3 | 5110 | Supply voltage too high | | X |
| Overheating | 5 | 1805 | Temperature exceeded on master | X | |
| | | 4000 | Temperature exceeded on device | | X |
| | | 4210 | | | |
| Wire break | 6 | 1800 | <ul style="list-style-type: none"> • No IO-Link device connected • There is a break on the signal line to the IO-Link device • IO-Link device cannot communicate due to a different error | X | |
| Overflow | 7 | 8C10 8C20 | Process tag range exceeded | | X |
| | | 8C20 | Measuring range exceeded | | |
| Underflow | 8 | 8C30 | Process tag range too low | | X |
| Error | 9 | --- | All IO-Link error codes that are not listed here are mapped to this PROFIBUS DP error | | X |
| Parameter assignment error | 16 | 1882 1883 | IO-Link master could not be configured | X | |
| | | 1802 | Incorrect device | | |
| | | 1886 | Storage error | | |
| | | 6320 6321 6350 | Device was not configured correctly | | X |
| Supply voltage missing | 17 | 1806 | L+ supply voltage for device missing | X | |
| | | 1807 | L+ supply voltage for device too low (<20 V) | | |

| Diagnostic alarm | Error code (decimal) | STATUS (W#16#..) | Meaning (IO-Link error code) | IO-Link master | IO-Link device |
|------------------|----------------------|--------------------------------------|---|----------------|----------------|
| Defective fuse | 18 | 5101 | Fuse on device is defective | | X |
| Safety shutdown | 25 | 1880 | Serious error (master has to be replaced) | X | |
| External fault | 26 | 1809 180A 180B 180C 180D | Error in data storage | X | |
| | | 1808 | More than 6 errors are pending simultaneously on the IO-Link device | | |

Technical specifications

A.1 General technical specifications

Standards compliance

The S7-1200 automation system design conforms with the following standards and test specifications. The test criteria for the S7-1200 automation system are based on these standards and test specifications.

Note that not all S7-1200 models may be certified to these standards, and certification status may change without notification. It is your responsibility to determine applicable certifications by referring to the ratings marked on the product. Consult your local Siemens representative if you need additional information related to the latest listing of exact approvals by part number.

CE approval



The S7-1200 Automation System satisfies requirements and safety related objectives according to the EC directives listed below, and conforms to the harmonized European standards (EN) for the programmable controllers listed in the Official Journals of the European Community.

- EC Directive 2006/95/EC (Low Voltage Directive) "Electrical Equipment Designed for Use within Certain Voltage Limits"
 - EN 61131-2:2007 Programmable controllers - Equipment requirements and tests
- EC Directive 2004/108/EC (EMC Directive) "Electromagnetic Compatibility"
 - Emission standard
EN 61000-6-4:2007: Industrial Environment
 - Immunity standard
EN 61000-6-2:2005: Industrial Environment
- EC Directive 94/9/EC (ATEX) "Equipment and Protective Systems Intended for Use in Potentially Explosive Atmosphere"
 - EN 60079-15:2005: Type of Protection 'n'

The CE Declaration of Conformity is held on file available to competent authorities at:

Siemens AG
IA AS RD ST PLC Amberg
Werner-von-Siemens-Str. 50
D92224 Amberg
Germany

cULus approval



Underwriters Laboratories Inc. complying with:

- Underwriters Laboratories, Inc.: UL 508 Listed (Industrial Control Equipment)
- Canadian Standards Association: CSA C22.2 Number 142 (Process Control Equipment)

Note

The SIMATIC S7-1200 series meets the CSA standard.

The cULus logo indicates that the S7-1200 has been examined and certified by Underwriters Laboratories (UL) to standards UL 508 and CSA 22.2 No. 142.

FM approval



Factory Mutual Research (FM)

Approval Standard Class Number 3600 and 3611

Approved for use in:

Class I, Division 2, Gas Group A, B, C, D, Temperature Class T3C Ta = 60 °C

Class I, Zone 2, IIC, Temperature Class T3 Ta = 60 °C

Canadian Class I, Zone 2 Installation per CEC 18-150

IMPORTANT EXCEPTION: See Technical Specifications for the number of inputs or outputs allowed on simultaneously. Some models are de-rated for Ta = 60 °C.

| |
|--|
|  WARNING |
|--|

| |
|--|
| Substitution of components can impair the suitability for Class I, Division 2 and Zone 2. |
|--|

| |
|---|
| Repair of units should only be performed by an authorized Siemens Service Center. |
|---|

ATEX approval



ATEX approval applies to DC models only. ATEX approval does not apply to AC and Relay models.

EN 60079-0:2009: Explosive Atmospheres - General Requirements

EN 60079-15:2010: Electrical Apparatus for Potentially Explosive Atmospheres;

Type of protection 'nA'

II 3 G Ex nA IIC T4 or T3 Gc

Install modules in a suitable enclosure providing a minimum degree of protection of IP54 according to EN 60529, or in a location providing an equivalent degree of protection.

Attached cables and conductors should be rated for the actual temperature measured under rated conditions.

The installation should ensure that transients are limited to less than 119 V. See Surge immunity in this section.

IMPORTANT EXCEPTION: See Technical Specifications for the number of inputs or outputs allowed on simultaneously. Some models are de-rated for Ta = 60 °C.

C-Tick approval



The S7-1200 automation system satisfies requirements of standards to AS/NZS 2064 (Class A).

Korea Certification



The S7-1200 automation system satisfies the requirements of the Korean Certification (KC Mark). It has been defined as Class A Equipment and is intended for industrial applications and has not been considered for home use.

Maritime approval

The S7-1200 products are periodically submitted for special agency approvals related to specific markets and applications. Consult your local Siemens representative if you need additional information related to the latest listing of exact approvals by part number.

Classification societies:

- ABS (American Bureau of Shipping)
- BV (Bureau Veritas)
- DNV (Det Norske Veritas)
- GL (Germanischer Lloyd)
- LRS (Lloyds Register of Shipping)
- Class NK (Nippon Kaiji Kyokai)
- Korean Register of Shipping

Industrial environments

The S7-1200 automation system is designed for use in industrial environments.

Table A- 1 Industrial environments

| Application field | Noise emission requirements | Noise immunity requirements |
|-------------------|-----------------------------|-----------------------------|
| Industrial | EN 61000-6-4:2007 | EN 61000-6-2:2005 |

A.1 General technical specifications

Electromagnetic compatibility

Electromagnetic Compatibility (EMC) is the ability of an electrical device to operate as intended in an electromagnetic environment and to operate without emitting levels of electromagnetic interference (EMI) that may disturb other electrical devices in the vicinity.

Table A-2 Immunity per EN 61000-6-2

| Electromagnetic compatibility - Immunity per EN 61000-6-2 | |
|--|---|
| EN 61000-4-2 Electrostatic discharge | 8 kV air discharge to all surfaces 6 kV contact discharge to exposed conductive surfaces |
| EN 61000-4-3 Radiated, radio-frequency, electromagnetic field immunity test | 80 to 1000 MHz, 10 V/m, 80% AM at 1 kHz 1.4 to 2.0 GHz, 3 V/m, 80% AM at 1 kHz 2.0 to 2.7 GHz, 1 V/m, 80% AM at 1 kHz |
| EN 61000-4-4 Fast transient bursts | 2 kV, 5 kHz with coupling network to AC and DC system power 2 kV, 5 kHz with coupling clamp to I/O |
| EN 61000-4-5 Surge immunity | AC systems - 2 kV common mode, 1 kV differential mode DC systems - 2 kV common mode, 1 kV differential mode For DC systems, refer to Surge immunity below |
| EN 61000-4-6 Conducted disturbances | 150 kHz to 80 MHz, 10 V RMS, 80% AM at 1kHz |
| EN 61000-4-11 Voltage dips | AC systems 0% for 1 cycle, 40% for 12 cycles and 70% for 30 cycles at 60 Hz |

Surge immunity

Wiring systems subject to surges from lightning strike coupling must be equipped with external protection. One specification for evaluation of protection from lightning type surges is found in EN 61000-4-5, with operational limits established by EN 61000-6-2. S7-1200 DC CPUs and signal modules require external protection to maintain safe operation when subject to surge voltages defined by this standard.

Listed below are some devices that support the needed surge immunity protection. These devices only provide the protection if they are properly installed according to the manufacturer's recommendations. Devices manufactured by other vendors with the same or better specifications can also be used:

- Supply Voltage, 24 VDC: DEHN, Inc., Type BVT AD 24, Part Number 918 402
- Digital Inputs, 24 VDC: DEHN, Inc., Type DCO RK E 24, Part Number 919 988
- Digital Outputs, 24 VDC: DEHN, Inc., Type DCO RK E 24, Part Number 919 988
- Analog Inputs: DEHN, Inc., Type BXT ML4 BD12, Part Number 920 342
- Analog Outputs: DEHN, Inc., Type DCO RK E 12, Part Number 919 987
- Ethernet: DEHN, Inc., Type DPA M CAT6 RJ45S 48, Part Number 929 100
- RS-232: DEHN, Inc., Type DCO RK E 12, Part Number 919 987
- RS-485: DEHN, Inc., Type BXT ML2 BE HFS 5, Part Number 920 270
- Relay Outputs: None required

Table A- 3 Conducted and radiated emissions per EN 61000-6-4

| Electromagnetic compatibility - Conducted and radiated emissions per EN 61000-6-4 | | |
|--|---------------------|--|
| Conducted Emissions EN 55011, Class A, Group 1 | 0.15 MHz to 0.5 MHz | <79dB (µV) quasi-peak; <66 dB (µV) average |
| | 0.5 MHz to 5 MHz | <73dB (µV) quasi-peak; <60 dB (µV) average |
| | 5 MHz to 30 MHz | <73dB (µV) quasi-peak; <60 dB (µV) average |
| Radiated Emissions EN 55011, Class A, Group 1 | 30 MHz to 230 MHz | <40dB (µV/m) quasi-peak; measured at 10m |
| | 230 MHz to 1 GHz | <47dB (µV/m) quasi-peak; measured at 10m |

Environmental conditions

Table A- 4 Transport and storage

| Environmental conditions - Transport and storage | |
|--|--|
| EN 60068-2-2, Test Bb, Dry heat and EN 60068-2-1, Test Ab, Cold | -40 °C to +70 °C |
| EN 60068-2-30, Test Db, Damp heat | 25 °C to 55 °C, 95% humidity |
| EN 60068-2-14, Test Na, temperature shock | -40 °C to +70 °C, dwell time 3 hours, 5 cycles |
| EN 60068-2-32, Free fall | 0.3 m, 5 times, product packaging |
| Atmospheric pressure | 1080 to 660h Pa (corresponding to an altitude of -1000 to 3500m) |

Table A- 5 Operating conditions

| Environmental conditions - Operating | |
|---|--|
| Ambient temperature range (Inlet Air 25 mm below unit) | -20 °C to 60 °C horizontal mounting -20 °C to 50 °C vertical mounting 95% non-condensing humidity Unless otherwise specified |
| Atmospheric pressure | 1080 to 795 hPa (corresponding to an altitude of -1000 to 2000m) |
| Concentration of contaminants | SO ₂ : < 0.5 ppm; H ₂ S: < 0.1 ppm; RH < 60% non-condensing |
| EN 60068-2-14, Test Nb, temperature change | 5 °C to 55 °C, 3 °C/minute |
| EN 60068-2-27 Mechanical shock | 15 G, 11 ms pulse, 6 shocks in each of 3 axis |
| EN 60068-2-6 Sinusoidal vibration | DIN rail mount: 3.5 mm from 5-9 Hz, 1G from 9 - 150 Hz Panel Mount: 7.0 mm from 5-9 Hz, 2G from 9 to 150 Hz 10 sweeps each axis, 1 octave per minute |

A.1 General technical specifications

Table A- 6 High potential isolation test

| High potential isolation test | |
|--|---|
| 24 VDC / 5 VDC nominal circuits | 520 VDC (type test of optical isolation boundaries) |
| 115 VAC / 230 VAC circuits to ground | 1500 VAC |
| 115 VAC / 230 VAC circuits to 115 VAC / 230 VAC circuits | 1500 VAC |
| 115 VAC / 230 VAC circuits to 24 VDC / 5 VDC circuits | 1500 VAC (3000 VAC/4242 VDC type test) |
| Ethernet port to 24 VDC / 5 VDC circuits and ground ¹ | 1500 VAC (type test only) |

¹ Ethernet port isolation is designed to limit hazard during short term network faults to hazardous voltages. It does not conform to safety requirements for routine AC line voltage isolation.

Protection class

- Protection Class II according to EN 61131-2 (Protective conductor not required)

Degree of protection

- IP20 Mechanical Protection, EN 60529
- Protects against finger contact with high voltage as tested by standard probe. External protection required for dust, dirt, water and foreign objects of < 12.5mm in diameter.

Rated voltages

Table A- 7 Rated voltages

| Rated voltage | Tolerance |
|---------------|--------------------------------|
| 24 VDC | 20.4 VDC to 28.8 VDC |
| 120/230 VAC | 85 VAC to 264 VAC, 47 to 63 Hz |

Note

When a mechanical contact turns on output power to the S7-1200 CPU, or any digital signal module, it sends a "1" signal to the digital outputs for approximately 50 microseconds. This could cause unexpected machine or process operation which could result in death or serious injury to personnel and/or damage to equipment. You must plan for this, especially if you are using devices which respond to short duration pulses.

Reverse voltage protection

Reverse voltage protection circuitry is provided on each terminal pair of +24 VDC power or user input power for CPUs, signal modules (SMs), and signal boards (SBs). It is still possible to damage the system by wiring different terminal pairs in opposite polarities.

Some of the 24 VDC power input ports in the S7-1200 system are interconnected, with a common logic circuit connecting multiple M terminals. For example, the following circuits are interconnected when designated as "not isolated" in the data sheets: the 24 VDC power supply of the CPU, the sensor power of the CPU, the power input for the relay coil of an SM, and the power supply for a non-isolated analog input. All non-isolated M terminals must connect to the same external reference potential.

WARNING

Connecting non-isolated M terminals to different reference potentials will cause unintended current flows that may cause damage or unpredictable operation in the PLC and any connected equipment.

Failure to comply with these guidelines could cause damage or unpredictable operation which could result in death or severe personal injury and/or property damage.

Always ensure that all non-isolated M terminals in an S7-1200 system are connected to the same reference potential.

DC Outputs

Short-circuit protection circuitry is not provided for DC outputs on CPUs, signal modules (SMs) and signal boards (SBs).

Relay electrical service life

The typical performance data estimated from sample tests is shown below. Actual performance may vary depending upon your specific application. An external protection circuit that is adapted to the load will enhance the service life of the contacts. N.C. contacts have a typical service life of about one-third that of the N.O. contact under inductive and lamp load conditions.

An external protective circuit will increase the service life of the contacts.

Technical specifications

A.1 General technical specifications

Table A- 8 Typical performance data

| Data for selecting an actuator | | | |
|---|--|-------------|--------------------------------------|
| Continuous thermal current | | 2 A max. | |
| Switching capacity and life of the contacts | | | |
| For ohmic load | Voltage | Current | Number of operating cycles (typical) |
| | 24 VDC | 2.0 A | 0.1 million |
| | 24 VDC | 1.0 A | 0.2 million |
| | 24 VDC | 0.5 A | 1.0 million |
| | 48 VAC | 1.5 A | 1.5 million |
| | 60 VAC | 1.5 A | 1.5 million |
| | 120 VAC | 2.0 A | 1.0 million |
| | 120 VAC | 1.0 A | 1.5 million |
| | 120 VAC | 0.5 A | 2.0 million |
| | 230 VAC | 2.0 A | 1.0 million |
| | 230 VAC | 1.0 A | 1.5 million |
| | 230 VAC | 0.5 A | 12.0 million |
| For inductive load (according to IEC 947-5-1 DC13/AC15) | Voltage | Current | Number of operating cycles (typical) |
| | 24 VDC | 2.0 A | 0.05 million |
| | 24 VDC | 1.0 A | 0.1 million |
| | 24 VDC | 0.5 A | 0.5 million |
| | 24 VAC | 1.5 A | 1.0 million |
| | 48 VAC | 1.5 A | 1.0 million |
| | 60 VAC | 1.5 A | 1.0 million |
| | 120 VAC | 2.0 A | 0.7 million |
| | 120 VAC | 1.0 A | 1.0 million |
| | 120 VAC | 0.5 A | 1.5 million |
| | 230 VAC | 2.0 A | 0.7 million |
| | 230 VAC | 1.0 A | 1.0 million |
| 230 VAC | 0.5 A | 1.5 million | |
| Activating a digital input | | Possible | |
| Switching frequency | | | |
| | Mechanical | Max. 10 Hz | |
| | At ohmic load | Max. 1 Hz | |
| | At inductive load (according to IEC 947-5-1 DC13/AC15) | Max. 0.5 Hz | |
| | At lamp load | Max. 1Hz | |

A.2 CPU 1211C

A.2.1 General specifications and features

Table A- 9 General specifications

| Technical data | CPU 1211C AC/DC/Relay | CPU 1211C DC/DC/Relay | CPU 1211C DC/DC/DC |
|--|----------------------------|----------------------------|----------------------------|
| Order number | 6ES7 211-1BE40-0XB0 | 6ES7 211-1HE40-0XB0 | 6ES7 211-1AE40-0XB0 |
| Dimensions W x H x D (mm) | 90 x 100 x 75 | 90 x 100 x 75 | 90 x 100 x 75 |
| Shipping weight | 420 grams | 380 grams | 370 grams |
| Power dissipation | 10 W | 8 W | 8 W |
| Current available (CM bus) | 750 mA max. (5 VDC) | 750 mA max. (5 VDC) | 750 mA max. (5 VDC) |
| Current available (24 VDC) | 300 mA max. (sensor power) | 300 mA max. (sensor power) | 300 mA max. (sensor power) |
| Digital input current consumption (24 VDC) | 4 mA/input used | 4 mA/input used | 4 mA/input used |

Table A- 10 CPU features

| Technical data | Description | |
|--------------------------------|--|---|
| User memory | Work | 30 Kbytes |
| | Load | 1 Mbyte internal, expandable up to SD card size |
| | Retentive | 10 Kbytes |
| On-board digital I/O | 6 inputs/4 outputs | |
| On-board analog I/O | 2 inputs | |
| Process image size | 1024 bytes of inputs (I) /1024 bytes of outputs (Q) | |
| Bit memory (M) | 4096 bytes | |
| Temporary (local) memory | <ul style="list-style-type: none"> 16 Kbytes for startup and program cycle (including associated FBs and FCs) 6 Kbytes for each of the other interrupt priority levels (including FBs and FCs) | |
| Signal modules expansion | none | |
| SB, CB, BB expansion | 1 max. | |
| Communication module expansion | 3 CMs max. | |
| High-speed counters | Up to 6 configured to use any built-in or SB inputs. Refer to table, CPU 1211C: HSC default address assignments (Page 411) 100/180 kHz (Ia.0 to Ia.5) | |
| Pulse outputs ² | Up to 4 configured to use any built-in or SB outputs 100 kHz (Qa.0 to Qa.3) | |
| Pulse catch inputs | 6 | |

A.2 CPU 1211C

| Technical data | Description |
|--------------------------------|---|
| Time delay interrupts | 4 total with 1 ms resolution |
| Cyclic interrupts | 4 total with 1 ms resolution |
| Edge interrupts | 6 rising and 6 falling (10 and 10 with optional signal board) |
| Memory card | SIMATIC Memory Card (optional) |
| Real time clock accuracy | +/- 60 seconds/month |
| Real time clock retention time | 20 days typ./12 days min. at 40 °C (maintenance-free Super Capacitor) |

¹ The slower speed is applicable when the HSC is configured for quadrature mode of operation.

² For CPU models with relay outputs, you must install a digital signal board (SB) to use the pulse outputs.

Table A- 11 Performance

| Type of instruction | Execution speed |
|---------------------|---------------------|
| Boolean | 0.08 µs/instruction |
| Move Word | 1.7 µs/instruction |
| Real math | 2.3 µs/instruction |

A.2.2 Timers, counters and code blocks supported by CPU 1211C

Table A- 12 Blocks, timers and counters supported by CPU 1211C

| Element | Description | |
|---------|-------------------------------------|--|
| Blocks | Type | OB, FB, FC, DB |
| | Size | 30 Kbytes |
| | Quantity | Up to 1024 blocks total (OBs + FBs + FCs + DBs) |
| | Address range for FBs, FCs, and DBs | FB and FC: 1 to 65535 (such as FB 1 to FB 65535) DB: 1 to 59999 |
| | Nesting depth | 16 from the program cycle or startup OB 6 from any interrupt event OB |
| | Monitoring | Status of 2 code blocks can be monitored simultaneously |
| OBs | Program cycle | Multiple |
| | Startup | Multiple |
| | Time-delay interrupt | 4 (1 per event) |
| | Cyclic interrupts | 4 (1 per event) |
| | Hardware interrupts | 50 (1 per event) |
| | Time error interrupts | 1 |
| | Diagnostic error interrupts | 1 |
| | Pull or plug of modules | 1 |
| | Rack or station failure | 1 |
| | Time of day | Multiple |
| Status | 1 | |

| Element | Description | |
|----------|-------------|---|
| | Update | 1 |
| | Profile | 1 |
| Timers | Type | IEC |
| | Quantity | Limited only by memory size |
| | Storage | Structure in DB, 16 bytes per timer |
| Counters | Type | IEC |
| | Quantity | Limited only by memory size |
| | Storage | Structure in DB, size dependent upon count type |
| | | <ul style="list-style-type: none"> • SInt, USInt: 3 bytes • Int, UInt: 6 bytes • DInt, UDInt: 12 bytes |

Table A- 13 Communication

| Technical data | Description |
|--|--|
| Number of ports | 1 |
| Type | Ethernet |
| HMI device | 3 |
| Programming device (PG) | 1 |
| Connections | <ul style="list-style-type: none"> • 8 for Open User Communication (active or passive): TSEND_C, TRCV_C, TCON, TDISCON, TSEND, and TRCV • 3 for server GET/PUT (CPU-to-CPU) S7 communication • 8 for client GET/PUT (CPU-to-CPU) S7 communication |
| Data rates | 10/100 Mb/s |
| Isolation (external signal to PLC logic) | Transformer isolated, 1500 VAC, for short term event safety only |
| Cable type | CAT5e shielded |

Table A- 14 Power supply

| Technical data | CPU 1211C AC/DC/Relay | CPU 1211C DC/DC/Relay | CPU 1211C DC/DC/DC |
|---|---|---------------------------------------|-----------------------|
| Voltage range | 85 to 264 VAC | 20.4 VDC to 28.8 VDC | |
| Line frequency | 47 to 63 Hz | -- | -- |
| Input current | CPU only at max. load | 60 mA at 120 VAC 30 mA at 240 VAC | 300 mA at 24 VDC |
| | CPU with all expansion accessories at max. load | 180 mA at 120 VAC 90 mA at 240 VAC | 900 mA at 24 VDC |
| Inrush current (max.) | 20 A at 264 VAC | 12 A at 28.8 VDC | 12 A at 28.8 VDC |
| Isolation (input power to logic) | 1500 VAC | Not isolated | Not isolated |
| Ground leakage, AC line to functional earth | 0.5 mA max. | -- | -- |

Technical specifications

A.2 CPU 1211C

| Technical data | CPU 1211C AC/DC/Relay | CPU 1211C DC/DC/Relay | CPU 1211C DC/DC/DC |
|-------------------------------------|--------------------------------------|----------------------------------|-------------------------------|
| Hold up time (loss of power) | 20 ms at 120 VAC 80 ms at 240 VAC | 10 ms at 24 VDC | 10 ms at 24 VDC |
| Internal fuse, not user replaceable | 3 A, 250 V, slow blow | 3 A, 250 V, slow blow | 3 A, 250 V, slow blow |

Table A- 15 Sensor power

| Technical data | CPU 1211C AC/DC/Relay | CPU 1211C DC/DC/Relay | CPU 1211C DC/DC/DC |
|---------------------------------------|----------------------------------|----------------------------------|----------------------------------|
| Voltage range | 20.4 to 28.8 VDC | L+ minus 4 VDC min. | |
| Output current rating (max.) | 300 mA (short-circuit protected) | 300 mA (short-circuit protected) | 300 mA (short-circuit protected) |
| Maximum ripple noise (<10 MHz) | < 1 V peak to peak | Same as input line | Same as input line |
| Isolation (CPU logic to sensor power) | Not isolated | Not isolated | Not isolated |

A.2.3 Digital inputs and outputs

Table A- 16 Digital inputs

| Technical data | CPU 1211C AC/DC/Relay, CPU 1211C DC/DC/Relay, and CPU 1211C DC/DC/DC |
|--|--|
| Number of inputs | 6 |
| Type | Sink/Source (IEC Type 1 sink) |
| Rated voltage | 24 VDC at 4 mA, nominal |
| Continuous permissible voltage | 30 VDC, max. |
| Surge voltage | 35 VDC for 0.5 sec. |
| Logic 1 signal (min.) | 15 VDC at 2.5 mA |
| Logic 0 signal (max.) | 5 VDC at 1 mA |
| Isolation (field side to logic) | 500 VAC for 1 minute |
| Isolation groups | 1 |
| Filter times | us settings: 0.1, 0.2, 0.4, 0.8, 1.6, 3.2, 6.4, 10.0, 12.8, 20.0 ms settings: 0.05, 0.1, 0.2, 0.4, 0.8, 1.6, 3.2, 6.4, 10.0, 12.8, 20.0 |
| HSC clock input rates (max.) (Logic 1 Level = 15 to 26 VDC) | 100/80 kHz (Ia.0 to Ia.5) |
| Number of inputs on simultaneously | 6 at 60 °C horizontal, 50 °C vertical |
| Cable length (meters) | 500 m shielded, 300 m unshielded, 50 m shielded for HSC inputs |

Table A- 17 Digital outputs

| Technical data | CPU 1211C AC/DC/Relay and CPU 1211C DC/DC/Relay | CPU 1211C DC/DC/DC |
|--|--|--|
| Number of outputs | 4 | 4 |
| Type | Relay, dry contact | Solid state - MOSFET (sourcing) |
| Voltage range | 5 to 30 VDC or 5 to 250 VAC | 20.4 to 28.8 VDC |
| Logic 1 signal at max. current | -- | 20 VDC min. |
| Logic 0 signal with 10 K Ω load | -- | 0.1 VDC max. |
| Current (max.) | 2.0 A | 0.5 A |
| Lamp load | 30 W DC / 200 W AC | 5 W |
| ON state resistance | 0.2 Ω max. when new | 0.6 Ω max. |
| Leakage current per point | -- | 10 μ A max. |
| Surge current | 7 A with contacts closed | 8 A for 100 ms max. |
| Overload protection | No | No |
| Isolation (field side to logic) | 1500 VAC for 1 minute (coil to contact) None (coil to logic) | 500 VAC for 1 minute |
| Isolation resistance | 100 M Ω min. when new | -- |
| Isolation between open contacts | 750 VAC for 1 minute | -- |
| Isolation groups | 1 | 1 |
| Inductive clamp voltage | -- | L+ minus 48 VDC, 1 W dissipation |
| Maximum relay switching frequency | 1 Hz | -- |
| Switching delay (Qa.0 to Qa.3) | 10 ms max. | 1.0 μ s max., off to on 3.0 μ s max., on to off |
| Pulse Train Output rate | Not recommended ¹ | 100 kHz (Qa.0 to Qa.3) ² , 2 Hz min. |
| Lifetime mechanical (no load) | 10,000,000 open/close cycles | -- |
| Lifetime contacts at rated load | 100,000 open/close cycles | -- |
| Behavior on RUN to STOP | Last value or substitute value (default value 0) | Last value or substitute value (default value 0) |
| Number of outputs on simultaneously | 4 at 60 °C horizontal, 50 °C vertical | |
| Cable length (meters) | 500 m shielded, 150 m unshielded | 500 m shielded, 150 m unshielded |

¹ For CPU models with relay outputs, you must install a digital signal board (SB) to use the pulse outputs.

² Depending on your pulse receiver and cable, an additional load resistor (at least 10% of rated current) may improve pulse signal quality and noise immunity.

A.2.4 Analog inputs

Table A- 18 Analog inputs

| Technical data | Description |
|---------------------------------|--|
| Number of inputs | 2 |
| Type | Voltage (single-ended) |
| Full-scale range | 0 to 10 V |
| Full-scale range (data word) | 0 to 27648 |
| Overshoot range | 10.001 to 11.759 V |
| Overshoot range (data word) | 27649 to 32511 |
| Overflow range | 11.760 to 11.852 V |
| Overflow range (data word) | 32512 to 32767 |
| Resolution | 10 bits |
| Maximum withstand voltage | 35 VDC |
| Smoothing | None, Weak, Medium, or Strong See the table for step response (ms) for the analog inputs of the CPU (Page 842). |
| Noise rejection | 10, 50, or 60 Hz |
| Impedance | ≥100 KΩ |
| Isolation (field side to logic) | None |
| Accuracy (25 °C / 0 to 55 °C) | 3.0% / 3.5% of full-scale |
| Cable length (meters) | 100 m, shielded twisted pair |

A.2.4.1 Step response of the built-in analog inputs of the CPU

Table A- 19 Step Response (ms), 0 V to 10 V measured at 95%

| Smoothing selection (sample averaging) | Rejection frequency (Integration time) | | |
|--|--|-------------|--------------|
| | 60 Hz | 50 Hz | 10 Hz |
| None (1 cycle): No averaging | 50 ms | 50 ms | 100 ms |
| Weak (4 cycles): 4 samples | 60ms | 70 ms | 200 ms |
| Medium (16 cycles): 16 samples | 200 ms | 240 ms | 1150 ms |
| Strong (32 cycles): 32 samples | 400 ms | 480 ms | 2300 ms |
| Sample time | 4.17 ms | 5 ms | 25 ms |

A.2.4.2 Sample time for the built-in analog ports of the CPU

Table A- 20 Sample time for built-in analog inputs of the CPU

| Rejection frequency (Integration time selection) | Sample time |
|--|-------------|
| 60 Hz (16.6 ms) | 4.17 ms |
| 50 Hz (20 ms) | 5 ms |
| 10 Hz (100 ms) | 25 ms |

A.2.4.3 Measurement ranges of the analog inputs for voltage (CPUs)

Table A- 21 Analog input representation for voltage (CPUs)

| System | | Voltage Measuring Range | |
|-----------------|-------------|-----------------------------------|-----------------|
| Decimal | Hexadecimal | 0 to 10 V | |
| 32767 | 7FFF | 11.851 V | Overflow |
| 32512 | 7F00 | | |
| 32511 | 7EFF | 11.759 V | Overshoot range |
| 27649 | 6C01 | | |
| 27648 | 6C00 | 10 V | Rated range |
| 20736 | 5100 | 7.5 V | |
| 34 | 22 | 12 mV | |
| 0 | 0 | 0 V | |
| Negative values | | Negative values are not supported | |

A.2.5 CPU 1211 wiring diagrams

Table A- 22 CPU 1211C AC/DC/Relay (6ES7 211-1BE40-0XB0)

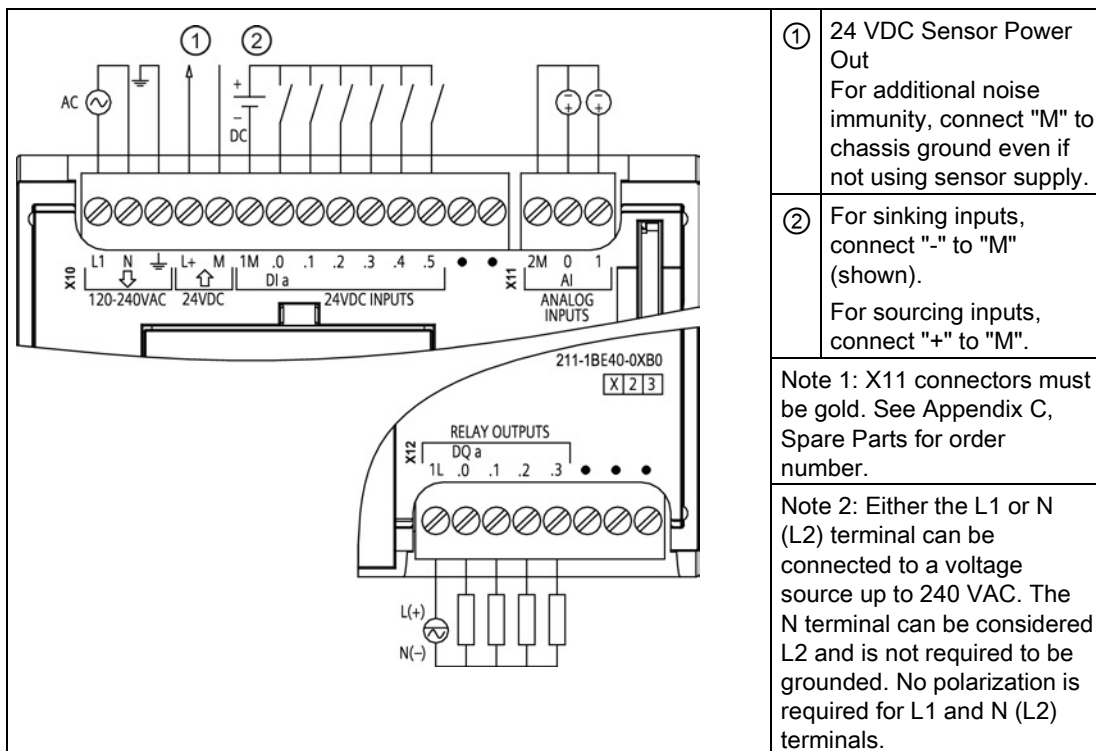

① 24 VDC Sensor Power Out
For additional noise immunity, connect "M" to chassis ground even if not using sensor supply.

② For sinking inputs, connect "-" to "M" (shown).
For sourcing inputs, connect "+" to "M".

Note 1: X11 connectors must be gold. See Appendix C, Spare Parts for order number.

Note 2: Either the L1 or N (L2) terminal can be connected to a voltage source up to 240 VAC. The N terminal can be considered L2 and is not required to be grounded. No polarization is required for L1 and N (L2) terminals.

Table A- 23 Connector pin locations for CPU 1211C AC/DC/Relay (6ES7 211-1BE40-0XB0)

| Pin | X10 | X11 (gold) | X12 |
|-----|------------------------|------------|---------------|
| 1 | L1 / 120-240 VAC | 2 M | 1L |
| 2 | N / 120-240 VAC | AI 0 | DQ a.0 |
| 3 | Functional Earth | AI 1 | DQ a.1 |
| 4 | L+ / 24 VDC Sensor Out | -- | DQ a.2 |
| 5 | M / 24 VDC Sensor Out | -- | DQ a.3 |
| 6 | 1M | -- | No connection |
| 7 | DI a.0 | -- | No connection |
| 8 | DI a.1 | -- | No connection |
| 9 | DI a.2 | -- | -- |
| 10 | DI a.3 | -- | -- |
| 11 | DI a.4 | -- | -- |
| 12 | DI a.5 | -- | -- |
| 13 | No connection | -- | -- |
| 14 | No connection | -- | -- |

Table A- 24 CPU 1211C DC/DC/Relay (6ES7 211-1HE40-0XB0)

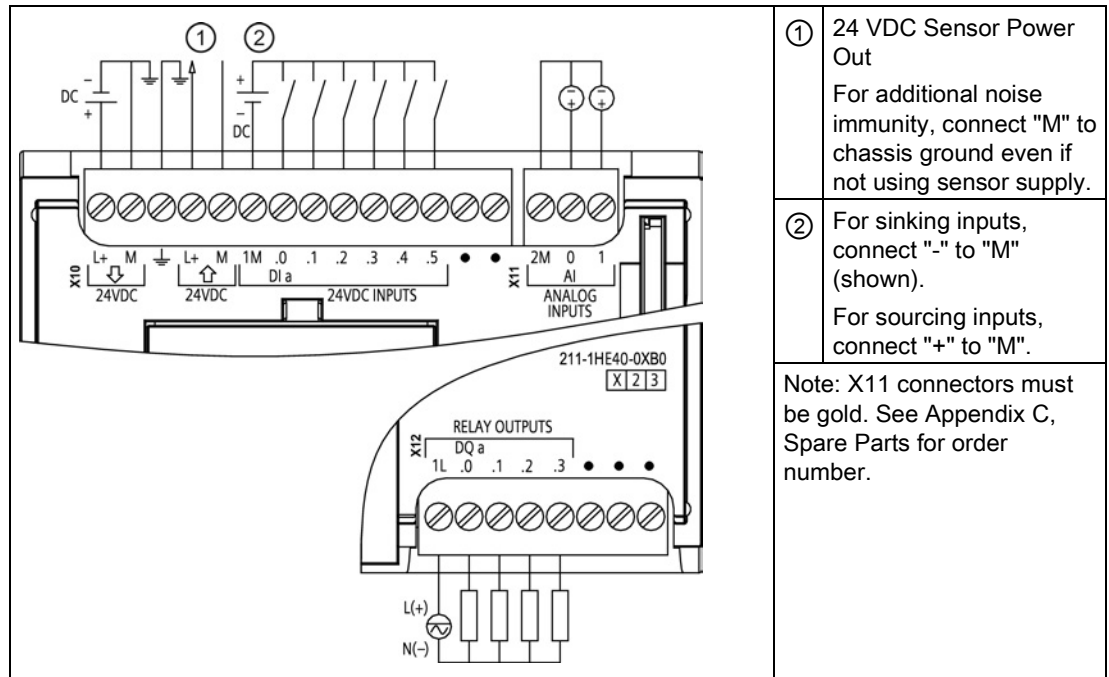

- ① 24 VDC Sensor Power Out
For additional noise immunity, connect "M" to chassis ground even if not using sensor supply.
 - ② For sinking inputs, connect "-" to "M" (shown).
For sourcing inputs, connect "+" to "M".
- Note: X11 connectors must be gold. See Appendix C, Spare Parts for order number.

Table A- 25 Connector pin locations for CPU 1211C DC/DC/Relay (6ES7 211-1HE40-0XB0)

| Pin | X10 | X11 (gold) | X12 |
|-----|------------------------|------------|---------------|
| 1 | L+ / 24 VDC | 2 M | 1L |
| 2 | M / 24 VDC | AI 0 | DQ a.0 |
| 3 | Functional Earth | AI 1 | DQ a.1 |
| 4 | L+ / 24 VDC Sensor Out | -- | DQ a.2 |
| 5 | M / 24 VDC Sensor Out | -- | DQ a.3 |
| 6 | 1M | -- | No connection |
| 7 | DI a.0 | -- | No connection |
| 8 | DI a.1 | -- | No connection |
| 9 | DI a.2 | -- | -- |
| 10 | DI a.3 | -- | -- |
| 11 | DI a.4 | -- | -- |
| 12 | DI a.5 | -- | -- |
| 13 | No connection | -- | -- |
| 14 | No connection | -- | -- |

Table A- 26 CPU 1211C DC/DC/DC (6ES7 211-1AE40-0XB0)

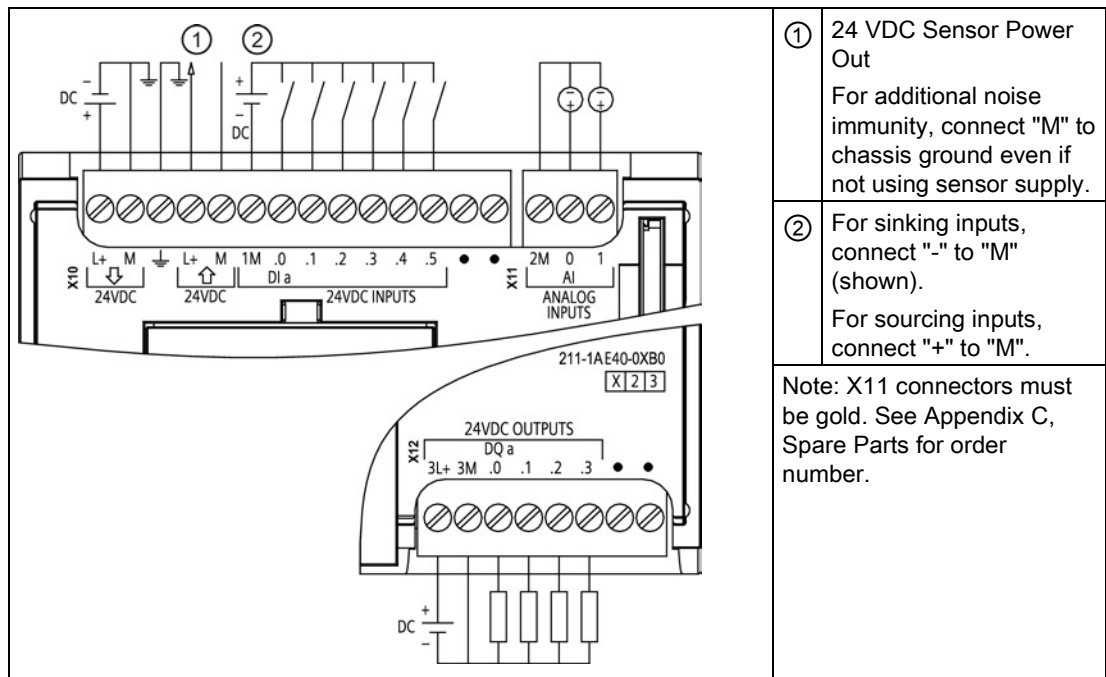

- ① 24 VDC Sensor Power Out
For additional noise immunity, connect "M" to chassis ground even if not using sensor supply.
 - ② For sinking inputs, connect "-" to "M" (shown).
For sourcing inputs, connect "+" to "M".
- Note: X11 connectors must be gold. See Appendix C, Spare Parts for order number.

Table A- 27 Connector pin locations for CPU 1211C DC/DC/DC (6ES7 211-1AE40-0XB0)

| Pin | X10 | X11 (gold) | X12 |
|-----|------------------------|------------|---------------|
| 1 | L+ / 24 VDC | 2 M | 3L+ |
| 2 | M / 24 VDC | AI 0 | 3M |
| 3 | Functional Earth | AI 1 | DQ a.0 |
| 4 | L+ / 24 VDC Sensor Out | -- | DQ a.1 |
| 5 | M / 24 VDC Sensor Out | -- | DQ a.2 |
| 6 | 1M | -- | DQ a.3 |
| 7 | DI a.0 | -- | No connection |
| 8 | DI a.1 | -- | No connection |
| 9 | DI a.2 | -- | -- |
| 10 | DI a.3 | -- | -- |
| 11 | DI a.4 | -- | -- |
| 12 | DI a.5 | -- | -- |
| 13 | No connection | -- | -- |
| 14 | No connection | -- | -- |

Note

Unused analog inputs should be shorted.

A.3 CPU 1212C

A.3.1 General specifications and features

Table A- 28 General

| Technical data | CPU 1212C AC/DC/Relay | CPU 1212C DC/DC/Relay | CPU 1212C DC/DC/DC |
|---|-------------------------------|-------------------------------|-------------------------------|
| Order number | 6ES7 212-1BE40-0XB0 | 6ES7 212-1HE40-0XB0 | 6ES7 212-1AE40-0XB0 |
| Dimensions W x H x D (mm) | 90 x 100 x 75 | 90 x 100 x 75 | 90 x 100 x 75 |
| Shipping weight | 425 grams | 385 grams | 370 grams |
| Power dissipation | 11 W | 9 W | 9 W |
| Current available (SM and CM bus) | 1000 mA max. (5 VDC) | 1000 mA max. (5 VDC) | 1000 mA max. (5 VDC) |
| Current available (24 VDC) | 300 mA max. (sensor power) | 300 mA max. (sensor power) | 300 mA max. (sensor power) |
| Digital input current consumption (24 VDC) | 4 mA/input used | 4 mA/input used | 4 mA/input used |

Table A- 29 CPU features

| Technical data | Description | |
|--------------------------------|--|---|
| User memory | Work | 50 Kbytes |
| | Load | 1 Mbyte internal, expandable up to SD card size |
| | Retentive | 10 Kbytes |
| On-board digital I/O | 8 inputs/6 outputs | |
| On-board analog I/O | 2 inputs | |
| Process image size | 1024 bytes of inputs (I)/1024 bytes of outputs (Q) | |
| Bit memory (M) | 4096 bytes | |
| Temporary (local) memory | <ul style="list-style-type: none"> • 16 Kbytes for startup and program cycle (including associated FBs and FCs) • 6 Kbytes for each of the other interrupt priority levels (including FBs and FCs) | |
| Signal modules expansion | 2 SMs max. | |
| SB, CB, BB expansion | 1 max. | |
| Communication module expansion | 3 CMs max. | |
| High-speed counters | Up to 6 configured to use any built-in or SB inputs. See table, CPU 1212C: HSC default address assignments (Page 411) <ul style="list-style-type: none"> • 100/180 kHz (Ia.0 to Ia.5) • 30 /120 kHz (Ia.6 to Ia.7) | |
| Pulse outputs ² | Up to 4 configured to use any built-in or SB outputs <ul style="list-style-type: none"> • 100 kHz (Qa.0 to Qa.3) • 30 kHz (Qa.4 to Qa.5) | |

A.3 CPU 1212C

| Technical data | Description |
|--------------------------------|---|
| Pulse catch inputs | 8 |
| Time delay interrupts | 4 total with 1 ms resolution |
| Cyclic interrupts | 4 total with 1 ms resolution |
| Edge interrupts | 8 rising and 8 falling (12 and 12 with optional signal board) |
| Memory card | SIMATIC Memory Card (optional) |
| Real time clock accuracy | +/- 60 seconds/month |
| Real time clock retention time | 20 days typ./12 days min. at 40 °C (maintenance-free Super Capacitor) |

¹ The slower speed is applicable when the HSC is configured for quadrature mode of operation.

² For CPU models with relay outputs, you must install a digital signal board (SB) to use the pulse outputs.

Table A- 30 Performance

| Type of instruction | Execution speed |
|---------------------|---------------------|
| Boolean | 0.08 µs/instruction |
| Move Word | 1.7 µs/instruction |
| Real math | 2.3 µs/instruction |

A.3.2 Timers, counters and code blocks supported by CPU 1212C

Table A- 31 Blocks, timers and counters supported by CPU 1212C

| Element | Description | |
|-----------------------------|-------------------------------------|--|
| Blocks | Type | OB, FB, FC, DB |
| | Size | 50 Kbytes |
| | Quantity | Up to 1024 blocks total (OBs + FBs + FCs + DBs) |
| | Address range for FBs, FCs, and DBs | FB and FC: 1 to 65535 (such as FB 1 to FB 65535) DB: 1 to 59999 |
| | Nesting depth | 16 from the program cycle or startup OB 6 from any interrupt event OB |
| | Monitoring | Status of 2 code blocks can be monitored simultaneously |
| | OBs | Program cycle |
| Startup | | Multiple |
| Time-delay interrupt | | 4 (1 per event) |
| Cyclic interrupts | | 4 (1 per event) |
| Hardware interrupts | | 50 (1 per event) |
| Time error interrupts | | 1 |
| Diagnostic error interrupts | | 1 |
| Pull or plug of modules | | 1 |
| Rack or station failure | | 1 |
| Time of day | Multiple | |

| Element | Description |
|----------|---|
| | Status 1 |
| | Update 1 |
| | Profile 1 |
| Timers | Type IEC |
| | Quantity Limited only by memory size |
| | Storage Structure in DB, 16 bytes per timer |
| Counters | Type IEC |
| | Quantity Limited only by memory size |
| | Storage Structure in DB, size dependent upon count type <ul style="list-style-type: none"> • SInt, USInt: 3 bytes • Int, UInt: 6 bytes • DInt, UDInt: 12 bytes |

Table A- 32 Communication

| Technical data | Description |
|--|--|
| Number of ports | 1 |
| Type | Ethernet |
| HMI device | 3 |
| Programming device (PG) | 1 |
| Connections | <ul style="list-style-type: none"> • 8 for Open User Communication (active or passive): TSEND_C, TRCV_C, TCON, TDISCON, TSEND, and TRCV • 3 for server GET/PUT (CPU-to-CPU) S7 communication • 8 for client GET/PUT (CPU-to-CPU) S7 communication |
| Data rates | 10/100 Mb/s |
| Isolation (external signal to PLC logic) | Transformer isolated, 1500 VAC, for short term event safety only |
| Cable type | CAT5e shielded |

Table A- 33 Power supply

| Technical data | | CPU 1212C AC/DC/Relay | CPU 1212C DC/DC/Relay | CPU 1212C DC/DC/DC |
|---|---------------------------------------|--|--------------------------|-----------------------|
| Voltage range | | 85 to 264 VAC | 20.4 VDC to 28.8 VDC | |
| Line frequency | | 47 to 63 Hz | -- | -- |
| Input current (max. load) | CPU only | 80 mA at 120 VAC 40 mA at 240 VAC | 400 mA at 24 VDC | 400 mA at 24 VDC |
| | CPU with all expansion accessories | 240 mA at 120 VAC 120 mA at 240 VAC | 1200 mA at 24 VDC | 1200 mA at 24 VDC |
| Inrush current (max.) | | 20 A at 264 VAC | 12 A at 28.8 VDC | 12 A at 28.8 VDC |
| Isolation (input power to logic) | | 1500 VAC | Not isolated | Not isolated |
| Ground leakage, AC line to functional earth | | 0.5 mA max. | -- | -- |

A.3 CPU 1212C

| Technical data | CPU 1212C AC/DC/Relay | CPU 1212C DC/DC/Relay | CPU 1212C DC/DC/DC |
|-------------------------------------|--------------------------------------|--------------------------|-----------------------|
| Hold up time (loss of power) | 20 ms at 120 VAC 80 ms at 240 VAC | 10 ms at 24 VDC | 10 ms at 24 VDC |
| Internal fuse, not user replaceable | 3 A, 250 V, slow blow | 3 A, 250 V, slow blow | 3 A, 250 V, slow blow |

Table A- 34 Sensor power

| Technical data | CPU 1212C AC/DC/Relay | CPU 1212C DC/DC/Relay | CPU 1212C DC/DC/DC |
|---------------------------------------|----------------------------------|----------------------------------|----------------------------------|
| Voltage range | 20.4 to 28.8 VDC | L+ minus 4 VDC min. | |
| Output current rating (max.) | 300 mA (short-circuit protected) | 300 mA (short-circuit protected) | 300 mA (short-circuit protected) |
| Maximum ripple noise (<10 MHz) | < 1 V peak to peak | Same as input line | Same as input line |
| Isolation (CPU logic to sensor power) | Not isolated | Not isolated | Not isolated |

A.3.3 Digital inputs and outputs

Table A- 35 Digital inputs

| Technical data | CPU 1212C AC/DC/Relay, DC/DC/Relay, and DC/DC/DC |
|--|--|
| Number of inputs | 8 |
| Type | Sink/Source (IEC Type 1 sink) |
| Rated voltage | 24 VDC at 4 mA, nominal |
| Continuous permissible voltage | 30 VDC, max. |
| Surge voltage | 35 VDC for 0.5 sec. |
| Logic 1 signal (min.) | 15 VDC at 2.5 mA |
| Logic 0 signal (max.) | 5 VDC at 1 mA |
| Isolation (field side to logic) | 500 VAC for 1 minute |
| Isolation groups | 1 |
| Filter times | us settings: 0.1, 0.2, 0.4, 0.8, 1.6, 3.2, 6.4, 10.0, 12.8, 20.0 ms settings: 0.05, 0.1, 0.2, 0.4, 0.8, 1.6, 3.2, 6.4, 10.0, 12.8, 20.0 |
| HSC clock input rates (max.) (Logic 1 Level = 15 to 26 VDC) | 100/80 kHz (Ia.0 to Ia.5) 30 /20 kHz (Ia.6 to Ia.7) |
| Number of inputs on simultaneously | 4 (no adjacent points) at 60 °C horizontal or 50 °C vertical 8 at 55 °C horizontal or 45 °C vertical |
| Cable length (meters) | 500 m shielded, 300 m unshielded, 50 m shielded for HSC inputs |

Table A- 36 Digital outputs

| Technical data | CPU 1212C AC/DC/Relay and DC/DC/Relay | CPU 1212C DC/DC/DC |
|--|--|---|
| Number of outputs | 6 | 6 |
| Type | Relay, dry contact | Solid state - MOSFET (sourcing) |
| Voltage range | 5 to 30 VDC or 5 to 250 VAC | 20.4 to 28.8 VDC |
| Logic 1 signal at max. current | -- | 20 VDC min. |
| Logic 0 signal with 10 K Ω load | -- | 0.1 VDC max. |
| Current (max.) | 2.0 A | 0.5 A |
| Lamp load | 30 W DC / 200 W AC | 5 W |
| ON state resistance | 0.2 Ω max. when new | 0.6 Ω max. |
| Leakage current per point | -- | 10 μ A max. |
| Surge current | 7 A with contacts closed | 8 A for 100 ms max. |
| Overload protection | No | No |
| Isolation (field side to logic) | 1500 VAC for 1 minute (coil to contact) None (coil to logic) | 500 VAC for 1 minute |
| Isolation resistance | 100 M Ω min. when new | -- |
| Isolation between open contacts | 750 VAC for 1 minute | -- |
| Isolation groups | 2 | 1 |
| Inductive clamp voltage | -- | L+ minus 48 VDC, 1 W dissipation |
| Switching delay (Qa.0 to Qa.3) | 10 ms max. | 1.0 μ s max., off to on 3.0 μ s max., on to off |
| Switching delay (Qa.4 to Qa.5) | 10 ms max. | 50 μ s max., off to on 200 μ s max., on to off |
| Maximum relay switching frequency | 1 Hz | -- |
| Pulse Train Output rate | Not recommended ¹ | 100 kHz (Qa.0 to Qa.3) ² , 2 Hz min. 20 kHz (Qa.4 to Qa.5) ² |
| Lifetime mechanical (no load) | 10,000,000 open/close cycles | -- |
| Lifetime contacts at rated load | 100,000 open/close cycles | -- |
| Behavior on RUN to STOP | Last value or substitute value (default value 0) | Last value or substitute value (default value 0) |
| Number of outputs on simultaneously | 3 (no adjacent points) at 60 °C horizontal or 50 °C vertical 6 at 55 °C horizontal, or 45 °C vertical | |
| Cable length (meters) | 500 m shielded, 150 m unshielded | 500 m shielded, 150 m unshielded |

¹ For CPU models with relay outputs, you must install a digital signal board (SB) to use the pulse outputs.

² Depending on your pulse receiver and cable, an additional load resistor (at least 10% of rated current) may improve pulse signal quality and noise immunity.

A.3.4 Analog inputs

Table A- 37 Analog inputs

| Technical data | Description |
|---------------------------------|--|
| Number of inputs | 2 |
| Type | Voltage (single-ended) |
| Full-scale range | 0 to 10 V |
| Full-scale range (data word) | 0 to 27648 |
| Overshoot range | 10.001 to 11.759 V |
| Overshoot range (data word) | 27649 to 32511 |
| Overflow range | 11.760 to 11.852 V |
| Overflow range (data word) | 32512 to 32767 |
| Resolution | 10 bits |
| Maximum withstand voltage | 35 VDC |
| Smoothing | None, Weak, Medium, or Strong See the table for step response (ms) for the analog inputs of the CPU (Page 852). |
| Noise rejection | 10, 50, or 60 Hz |
| Impedance | ≥100 KΩ |
| Isolation (field side to logic) | None |
| Accuracy (25 °C / 0 to 55 °C) | 3.0% / 3.5% of full-scale |
| Cable length (meters) | 100 m, shielded twisted pair |

A.3.4.1 Step response of the built-in analog inputs of the CPU

Table A- 38 Step Response (ms), 0 V to 10 V measured at 95%

| Smoothing selection (sample averaging) | Rejection frequency (Integration time) | | |
|--|--|-------------|--------------|
| | 60 Hz | 50 Hz | 10 Hz |
| None (1 cycle): No averaging | 50 ms | 50 ms | 100 ms |
| Weak (4 cycles): 4 samples | 60ms | 70 ms | 200 ms |
| Medium (16 cycles): 16 samples | 200 ms | 240 ms | 1150 ms |
| Strong (32 cycles): 32 samples | 400 ms | 480 ms | 2300 ms |
| Sample time | 4.17 ms | 5 ms | 25 ms |

A.3.4.2 Sample time for the built-in analog ports of the CPU

Table A- 39 Sample time for built-in analog inputs of the CPU

| Rejection frequency (Integration time selection) | Sample time |
|--|-------------|
| 60 Hz (16.6 ms) | 4.17 ms |
| 50 Hz (20 ms) | 5 ms |
| 10 Hz (100 ms) | 25 ms |

A.3.4.3 Measurement ranges of the analog inputs for voltage (CPUs)

Table A- 40 Analog input representation for voltage (CPUs)

| System | | Voltage Measuring Range | |
|-----------------|-------------|-----------------------------------|-----------------|
| Decimal | Hexadecimal | 0 to 10 V | |
| 32767 | 7FFF | 11.851 V | Overflow |
| 32512 | 7F00 | | |
| 32511 | 7EFF | 11.759 V | Overshoot range |
| 27649 | 6C01 | | |
| 27648 | 6C00 | 10 V | Rated range |
| 20736 | 5100 | 7.5 V | |
| 34 | 22 | 12 mV | |
| 0 | 0 | 0 V | |
| Negative values | | Negative values are not supported | |

A.3.5 CPU 1212C wiring diagrams

Table A- 41 CPU 1212C AC/DC/Relay (6ES7 212-1BE40-0XB0)

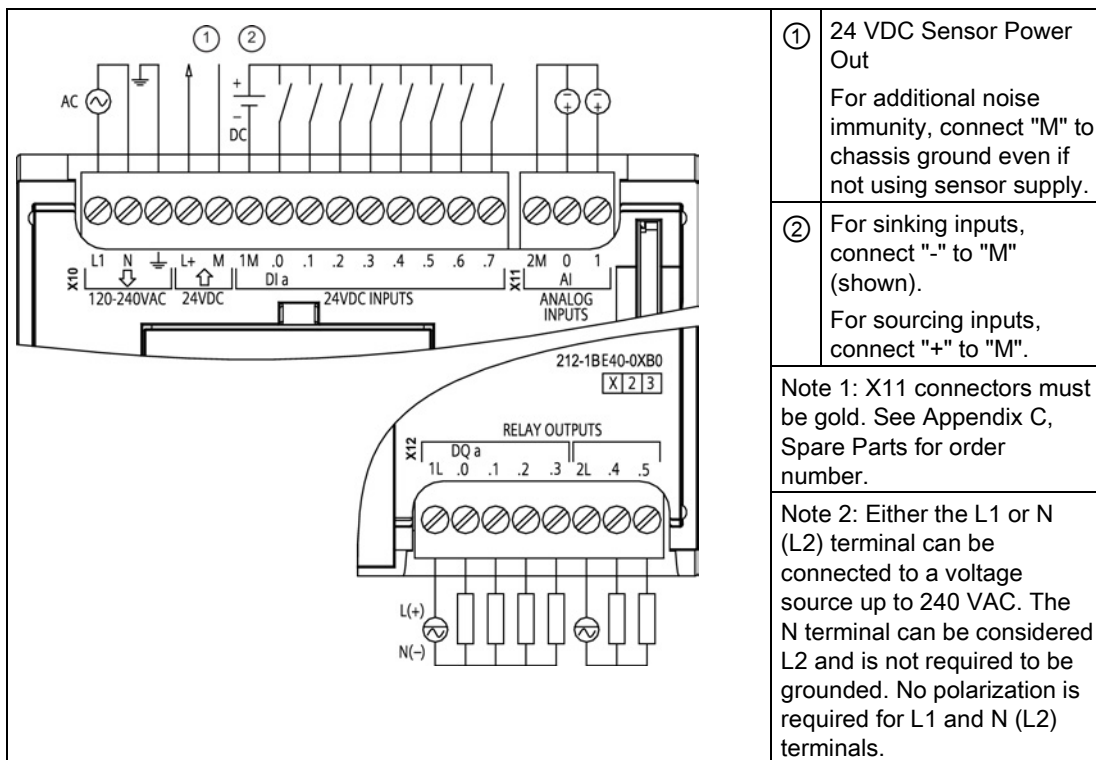
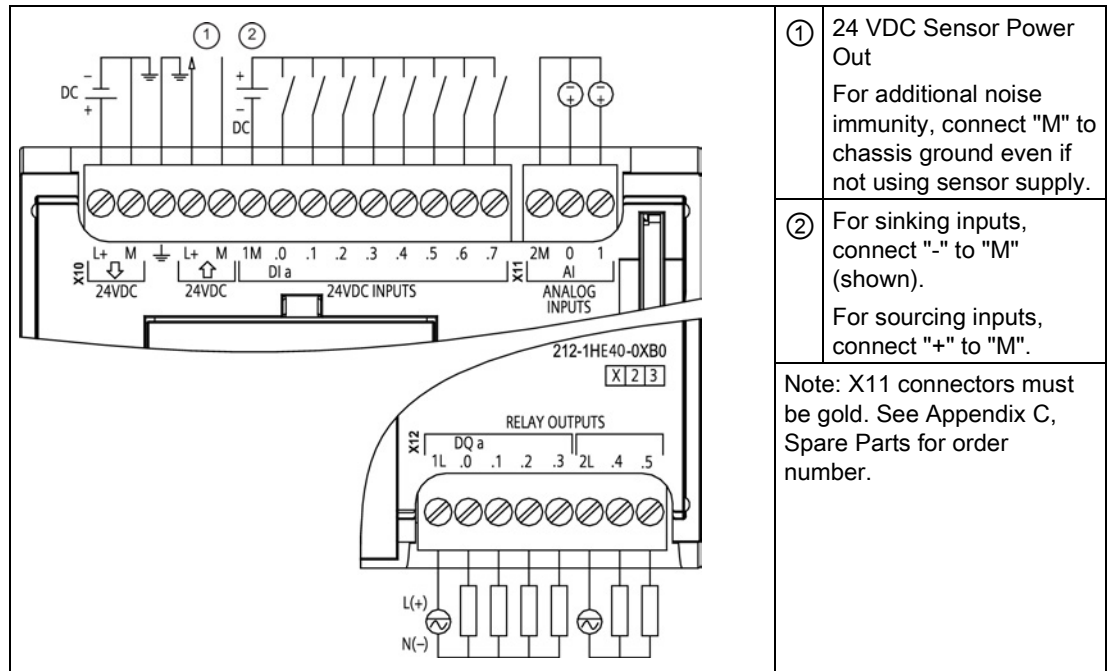

Table A- 42 Connector pin locations for CPU 1212C AC/DC/Relay (6ES7 212-1BE40-0XB0)

| Pin | X10 | X11 (gold) | X12 |
|-----|------------------------|------------|--------|
| 1 | L1 / 120-240 VAC | 2 M | 1L |
| 2 | N / 120-240 VAC | AI 0 | DQ a.0 |
| 3 | Functional Earth | AI 1 | DQ a.1 |
| 4 | L+ / 24 VDC Sensor Out | -- | DQ a.2 |
| 5 | M / 24 VDC Sensor Out | -- | DQ a.3 |
| 6 | 1M | -- | 2L |
| 7 | DI a.0 | -- | DQ a.4 |
| 8 | DI a.1 | -- | DQ a.5 |
| 9 | DI a.2 | -- | -- |
| 10 | DI a.3 | -- | -- |
| 11 | DI a.4 | -- | -- |
| 12 | DI a.5 | -- | -- |
| 13 | DI a.6 | -- | -- |
| 14 | DI a.7 | -- | -- |

Table A- 43 CPU 1212C DC/DC/Relay (6ES7 212-1HE40-0XB0)



① 24 VDC Sensor Power Out
 For additional noise immunity, connect "M" to chassis ground even if not using sensor supply.

② For sinking inputs, connect "-" to "M" (shown).
 For sourcing inputs, connect "+" to "M".

Note: X11 connectors must be gold. See Appendix C, Spare Parts for order number.

Table A- 44 Connector pin locations for CPU 1212C DC/DC/Relay (6ES7 212-1HE40-0XB0)

| Pin | X10 | X11 (gold) | X12 |
|-----|------------------------|------------|--------|
| 1 | L+ / 24 VDC | 2 M | 1L |
| 2 | M / 24 VDC | AI 0 | DQ a.0 |
| 3 | Functional Earth | AI 1 | DQ a.1 |
| 4 | L+ / 24 VDC Sensor Out | -- | DQ a.2 |
| 5 | M / 24 VDC Sensor Out | -- | DQ a.3 |
| 6 | 1M | -- | 2L |
| 7 | DI a.0 | -- | DQ a.4 |
| 8 | DI a.1 | -- | DQ a.5 |
| 9 | DI a.2 | -- | -- |
| 10 | DI a.3 | -- | -- |
| 11 | DI a.4 | -- | -- |
| 12 | DI a.5 | -- | -- |
| 13 | DI a.6 | -- | -- |
| 14 | DI a.7 | -- | -- |

Table A- 45 CPU 1212C DC/DC/DC (6ES7-212-1AE40-0XB0)

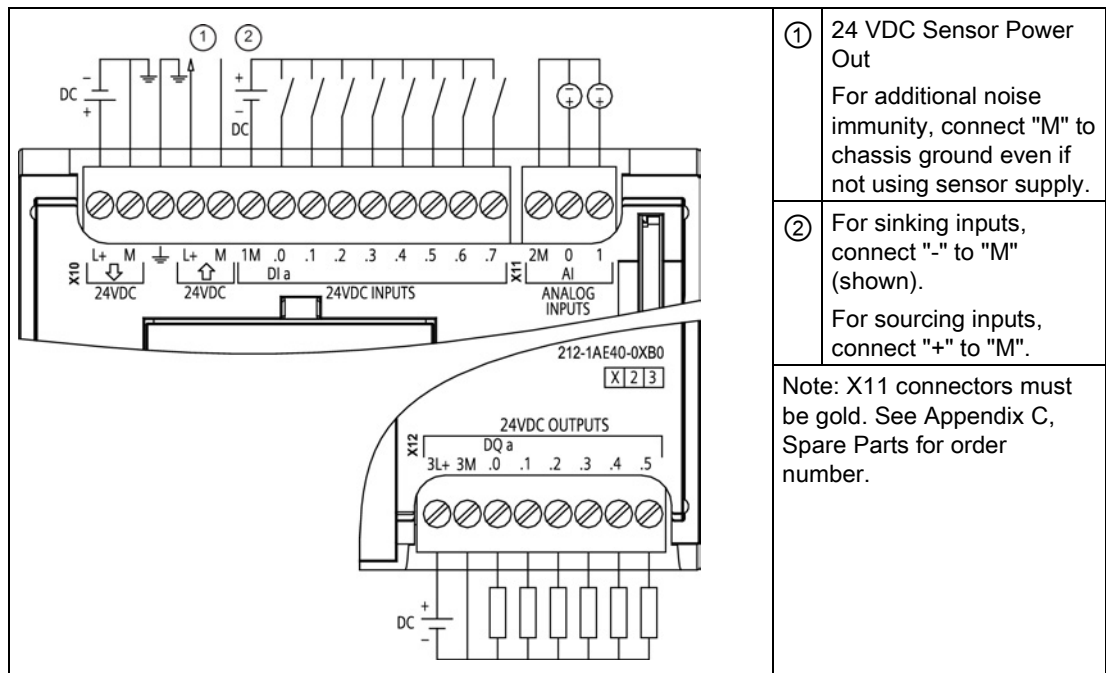

Table A- 46 Connector pin locations for CPU 1212C DC/DC/DC (6ES7 212-1AE40-0XB0)

| Pin | X10 | X11 (gold) | X12 |
|-----|------------------------|------------|--------|
| 1 | L+ / 24 VDC | 2 M | 3L+ |
| 2 | M / 24 VDC | AI 0 | 3M |
| 3 | Functional Earth | AI 1 | DQ a.0 |
| 4 | L+ / 24 VDC Sensor Out | -- | DQ a.1 |
| 5 | M / 24 VDC Sensor Out | -- | DQ a.2 |
| 6 | 1M | -- | DQ a.3 |
| 7 | DI a.0 | -- | DQ a.4 |
| 8 | DI a.1 | -- | DQ a.5 |
| 9 | DI a.2 | -- | -- |
| 10 | DI a.3 | -- | -- |
| 11 | DI a.4 | -- | -- |
| 12 | DI a.5 | -- | -- |
| 13 | DI a.6 | -- | -- |
| 14 | DI a.7 | -- | -- |

Note

Unused analog inputs should be shorted.

A.4 CPU 1214C

A.4.1 General specifications and features

Table A- 47 General

| Technical data | CPU 1214C AC/DC/Relay | CPU 1214C DC/DC/Relay | CPU 1214C DC/DC/DC |
|---|-------------------------------|-------------------------------|-------------------------------|
| Order number | 6ES7 214-1BG40-0XB0 | 6ES7 214-1HG40-0XB0 | 6ES7 214-1AG40-0XB0 |
| Dimensions W x H x D (mm) | 110 x 100 x 75 | 110 x 100 x 75 | 110 x 100 x 75 |
| Shipping weight | 475 grams | 435 grams | 415 grams |
| Power dissipation | 14 W | 12 W | 12 W |
| Current available (SM and CM bus) | 1600 mA max. (5 VDC) | 1600 mA max. (5 VDC) | 1600 mA max. (5 VDC) |
| Current available (24 VDC) | 400 mA max. (sensor power) | 400 mA max. (sensor power) | 400 mA max. (sensor power) |
| Digital input current consumption (24 VDC) | 4 mA/input used | 4 mA/input used | 4 mA/input used |

Table A- 48 CPU features

| Technical data | Description | |
|--------------------------------|---|--|
| User memory | Work | 75 Kbytes |
| | Load | 4 Mbytes internal, expandable up to SD card size |
| | Retentive | 10 Kbytes |
| On-board digital I/O | 14 inputs/10 outputs | |
| On-board analog I/O | 2 inputs | |
| Process image size | 1024 bytes of inputs (I)/1024 bytes of outputs (Q) | |
| Bit memory (M) | 8192 bytes | |
| Temporary (local) memory | <ul style="list-style-type: none"> • 16 Kbytes for startup and program cycle (including associated FBs and FCs) • 6 Kbytes for each of the other interrupt priority levels (including FBs and FCs) | |
| Signal modules expansion | 8 SMs max. | |
| SB, CB, BB expansion | 1 max. | |
| Communication module expansion | 3 CMs max. | |
| High-speed counters | <p>Up to 6 configured to use any built-in or SB inputs. See table, CPU1214C: HSC default address assignments (Page 411)</p> <ul style="list-style-type: none"> • 100/180 kHz (Ia.0 to Ia.5) • 30/120 kHz (Ia.6 to Ib.5) | |

A.4 CPU 1214C

| Technical data | Description |
|--------------------------------|--|
| Pulse outputs ² | Up to 4 configured to use any built-in or SB outputs <ul style="list-style-type: none"> • 100 kHz (Qa.0 to Qa.3) • 30 kHz (Qa.4 to Qb.1) |
| Pulse catch inputs | 14 |
| Time delay interrupts | 4 total with 1 ms resolution |
| Cyclic interrupts | 4 total with 1 ms resolution |
| Edge interrupts | 12 rising and 12 falling (16 and 16 with optional signal board) |
| Memory card | SIMATIC Memory Card (optional) |
| Real time clock accuracy | +/- 60 seconds/month |
| Real time clock retention time | 20 days typ./12 days min. at 40 °C (maintenance-free Super Capacitor) |

¹ The slower speed is applicable when the HSC is configured for quadrature mode of operation.

² For CPU models with relay outputs, you must install a digital signal board (SB) to use the pulse outputs.

Table A- 49 Performance

| Type of instruction | Execution speed |
|---------------------|---------------------|
| Boolean | 0.08 µs/instruction |
| Move Word | 1.7 µs/instruction |
| Real math | 2.3 µs/instruction |

A.4.2 Timers, counters and code blocks supported by CPU 1214C

Table A- 50 Blocks, timers and counters supported by CPU 1214C

| Element | Description | |
|---------|-------------------------------------|--|
| Blocks | Type | OB, FB, FC, DB |
| | Size | 64 Kbytes |
| | Quantity | Up to 1024 blocks total (OBs + FBs + FCs + DBs) |
| | Address range for FBs, FCs, and DBs | FB and FC: 1 to 65535 (such as FB 1 to FB 65535) DB: 1 to 59999 |
| | Nesting depth | 16 from the program cycle or startup OB 6 from any interrupt event OB |
| | Monitoring | Status of 2 code blocks can be monitored simultaneously |
| OBs | Program cycle | Multiple |
| | Startup | Multiple |
| | Time-delay interrupts | 4 (1 per event) |
| | Cyclic interrupts | 4 (1 per event) |
| | Hardware interrupts | 50 (1 per event) |
| | Time error interrupts | 1 |
| | Diagnostic error interrupts | 1 |

| Element | Description |
|----------|---|
| | Pull or plug of modules 1 |
| | Rack or station failure 1 |
| | Time of day Multiple |
| | Status 1 |
| | Update 1 |
| | Profile 1 |
| Timers | Type IEC |
| | Quantity Limited only by memory size |
| | Storage Structure in DB, 16 bytes per timer |
| Counters | Type IEC |
| | Quantity Limited only by memory size |
| | Storage Structure in DB, size dependent upon count type <ul style="list-style-type: none"> • SInt, USInt: 3 bytes • Int, UInt: 6 bytes • DInt, UDInt: 12 bytes |

Table A- 51 Communication

| Technical data | Description |
|--|--|
| Number of ports | 1 |
| Type | Ethernet |
| HMI device | 3 |
| Programming device (PG) | 1 |
| Connections | <ul style="list-style-type: none"> • 8 for Open User Communication (active or passive): TSEND_C, TRCV_C, TCON, TDISCON, TSEND, and TRCV • 3 for server GET/PUT (CPU-to-CPU) S7 communication • 8 for client GET/PUT (CPU-to-CPU) S7 communication |
| Data rates | 10/100 Mb/s |
| Isolation (external signal to PLC logic) | Transformer isolated, 1500 VAC, for short term event safety only |
| Cable type | CAT5e shielded |

Table A- 52 Power supply

| Technical data | CPU 1214C AC/DC/Relay | CPU 1214C DC/DC/Relay | CPU 1214C DC/DC/DC |
|---------------------------|------------------------------------|--|-----------------------|
| Voltage range | 85 to 264 VAC | 20.4 VDC to 28.8 VDC | |
| Line frequency | 47 to 63 Hz | -- | |
| Input current (max. load) | CPU only | 100 mA at 120 VAC 50 mA at 240 VAC | 500 mA at 24 VDC |
| | CPU with all expansion accessories | 300 mA at 120 VAC 150 mA at 240 VAC | 1500 mA at 24 VDC |
| Inrush current (max.) | 20 A at 264 VAC | 12 A at 28.8 VDC | |

A.4 CPU 1214C

| Technical data | CPU 1214C AC/DC/Relay | CPU 1214C DC/DC/Relay | CPU 1214C DC/DC/DC |
|---|--------------------------------------|--------------------------|-----------------------|
| Isolation (input power to logic) | 1500 VAC | Not isolated | |
| Ground leakage, AC line to functional earth | 0.5 mA max. | - | |
| Hold up time (loss of power) | 20 ms at 120 VAC 80 ms at 240 VAC | 10 ms at 24 VDC | |
| Internal fuse, not user replaceable | 3 A, 250 V, slow blow | | |

Table A- 53 Sensor power

| Technical data | CPU 1214C AC/DC/Relay | CPU 1214C DC/DC/Relay | CPU 1214C DC/DC/DC |
|---------------------------------------|----------------------------------|--------------------------|-----------------------|
| Voltage range | 20.4 to 28.8 VDC | L+ minus 4 VDC min. | |
| Output current rating (max.) | 400 mA (short-circuit protected) | | |
| Maximum ripple noise (<10 MHz) | < 1 V peak to peak | Same as input line | |
| Isolation (CPU logic to sensor power) | Not isolated | | |

A.4.3 Digital inputs and outputs

Table A- 54 Digital inputs

| Technical data | CPU 1214C AC/DC/Relay | CPU 1214C DC/DC/Relay | CPU 1214C DC/DC/DC |
|--|--|--------------------------|-----------------------|
| Number of inputs | 14 | | |
| Type | Sink/Source (IEC Type 1 sink) | | |
| Rated voltage | 24 VDC at 4 mA, nominal | | |
| Continuous permissible voltage | 30 VDC, max. | | |
| Surge voltage | 35 VDC for 0.5 sec. | | |
| Logic 1 signal (min.) | 15 VDC at 2.5 mA | | |
| Logic 0 signal (max.) | 5 VDC at 1 mA | | |
| Isolation (field side to logic) | 500 VAC for 1 minute | | |
| Isolation groups | 1 | | |
| Filter times | us settings: 0.1, 0.2, 0.4, 0.8, 1.6, 3.2, 6.4, 10.0, 12.8, 20.0 ms settings: 0.05, 0.1, 0.2, 0.4, 0.8, 1.6, 3.2, 6.4, 10.0, 12.8, 20.0 | | |
| HSC clock input rates (max.) (Logic 1 Level = 15 to 26 VDC) | 100/80 kHz (Ia.0 to Ia.5) 30/20 kHz (Ia.6 to Ib.5) | | |
| Number of inputs on simultaneously | <ul style="list-style-type: none"> 7 (no adjacent points) at 60 °C horizontal or 50 °C vertical 14 at 55 °C horizontal or 45 °C vertical | | |
| Cable length (meters) | 500 m shielded, 300 m unshielded, 50 m shielded for HSC inputs | | |

Table A- 55 Digital outputs

| Technical data | CPU 1214C AC/DC/Relay and DC/DC/Relay | CPU 1214C DC/DC/DC |
|--|--|---|
| Number of outputs | 10 | 10 |
| Type | Relay, dry contact | Solid state - MOSFET (sourcing) |
| Voltage range | 5 to 30 VDC or 5 to 250 VAC | 20.4 to 28.8 VDC |
| Logic 1 signal at max. current | -- | 20 VDC min. |
| Logic 0 signal with 10 K Ω load | -- | 0.1 VDC max. |
| Current (max.) | 2.0 A | 0.5 A |
| Lamp load | 30 W DC / 200 W AC | 5 W |
| ON state resistance | 0.2 Ω max. when new | 0.6 Ω max. |
| Leakage current per point | -- | 10 μ A max. |
| Surge current | 7 A with contacts closed | 8 A for 100 ms max. |
| Overload protection | No | No |
| Isolation (field side to logic) | 1500 VAC for 1 minute (coil to contact) None (coil to logic) | 500 VAC for 1 minute |
| Isolation resistance | 100 M Ω min. when new | -- |
| Isolation between open contacts | 750 VAC for 1 minute | -- |
| Isolation groups | 2 | 1 |
| Inductive clamp voltage | -- | L+ minus 48 VDC, 1 W dissipation |
| Switching delay (Qa.0 to Qa.3) | 10 ms max. | 1.0 μ s max., off to on 3.0 μ s max., on to off |
| Switching delay (Qa.4 to Qb.1) | 10 ms max. | 50 μ s max., off to on 200 μ s max., on to off |
| Maximum relay switching frequency | 1 Hz | -- |
| Pulse Train Output rate | Not recommended ¹ | 100 kHz (Qa.0 to Qa.3) ² , 2 Hz min. 20 kHz (Qa.4 to Qb.1) ² |
| Lifetime mechanical (no load) | 10,000,000 open/close cycles | -- |
| Lifetime contacts at rated load | 100,000 open/close cycles | -- |
| Behavior on RUN to STOP | Last value or substitute value (default value 0) | |
| Number of outputs on simultaneously | <ul style="list-style-type: none"> • 5 (no adjacent points) at 60 °C horizontal or 50 °C vertical • 10 at 55 °C horizontal or 45 °C vertical | |
| Cable length (meters) | 500 m shielded, 150 m unshielded | |

¹ For CPU models with relay outputs, you must install a digital signal board (SB) to use the pulse outputs.

² Depending on your pulse receiver and cable, an additional load resistor (at least 10% of rated current) may improve pulse signal quality and noise immunity.

A.4.4 Analog inputs

Table A- 56 Analog inputs

| Technical data | Description |
|---------------------------------|--|
| Number of inputs | 2 |
| Type | Voltage (single-ended) |
| Full-scale range | 0 to 10 V |
| Full-scale range (data word) | 0 to 27648 |
| Overshoot range | 10.001 to 11.759 V |
| Overshoot range (data word) | 27649 to 32511 |
| Overflow range | 11.760 to 11.852 V |
| Overflow range (data word) | 32512 to 32767 |
| Resolution | 10 bits |
| Maximum withstand voltage | 35 VDC |
| Smoothing | None, Weak, Medium, or Strong See the table for step response (ms) for the analog inputs of the CPU (Page 862). |
| Noise rejection | 10, 50, or 60 Hz |
| Impedance | ≥100 KΩ |
| Isolation (field side to logic) | None |
| Accuracy (25 °C / 0 to 55 °C) | 3.0% / 3.5% of full-scale |
| Cable length (meters) | 100 m, shielded twisted pair |

A.4.4.1 Step response of the built-in analog inputs of the CPU

Table A- 57 Step Response (ms), 0 V to 10 V measured at 95%

| Smoothing selection (sample averaging) | Rejection frequency (Integration time) | | |
|--|--|-------------|--------------|
| | 60 Hz | 50 Hz | 10 Hz |
| None (1 cycle): No averaging | 50 ms | 50 ms | 100 ms |
| Weak (4 cycles): 4 samples | 60ms | 70 ms | 200 ms |
| Medium (16 cycles): 16 samples | 200 ms | 240 ms | 1150 ms |
| Strong (32 cycles): 32 samples | 400 ms | 480 ms | 2300 ms |
| Sample time | 4.17 ms | 5 ms | 25 ms |

A.4.4.2 Sample time for the built-in analog ports of the CPU

Table A- 58 Sample time for built-in analog inputs of the CPU

| Rejection frequency (Integration time selection) | Sample time |
|--|-------------|
| 60 Hz (16.6 ms) | 4.17 ms |
| 50 Hz (20 ms) | 5 ms |
| 10 Hz (100 ms) | 25 ms |

A.4.4.3 Measurement ranges of the analog inputs for voltage (CPUs)

Table A- 59 Analog input representation for voltage (CPUs)

| System | | Voltage Measuring Range | |
|-----------------|-------------|-----------------------------------|-----------------|
| Decimal | Hexadecimal | 0 to 10 V | |
| 32767 | 7FFF | 11.851 V | Overflow |
| 32512 | 7F00 | | |
| 32511 | 7EFF | 11.759 V | Overshoot range |
| 27649 | 6C01 | | |
| 27648 | 6C00 | 10 V | Rated range |
| 20736 | 5100 | 7.5 V | |
| 34 | 22 | 12 mV | |
| 0 | 0 | 0 V | |
| Negative values | | Negative values are not supported | |

A.4.5 CPU 1214C wiring diagrams

Table A- 60 CPU 1214C AC/DC/Relay (6ES7 214-1BG40-0XB0)

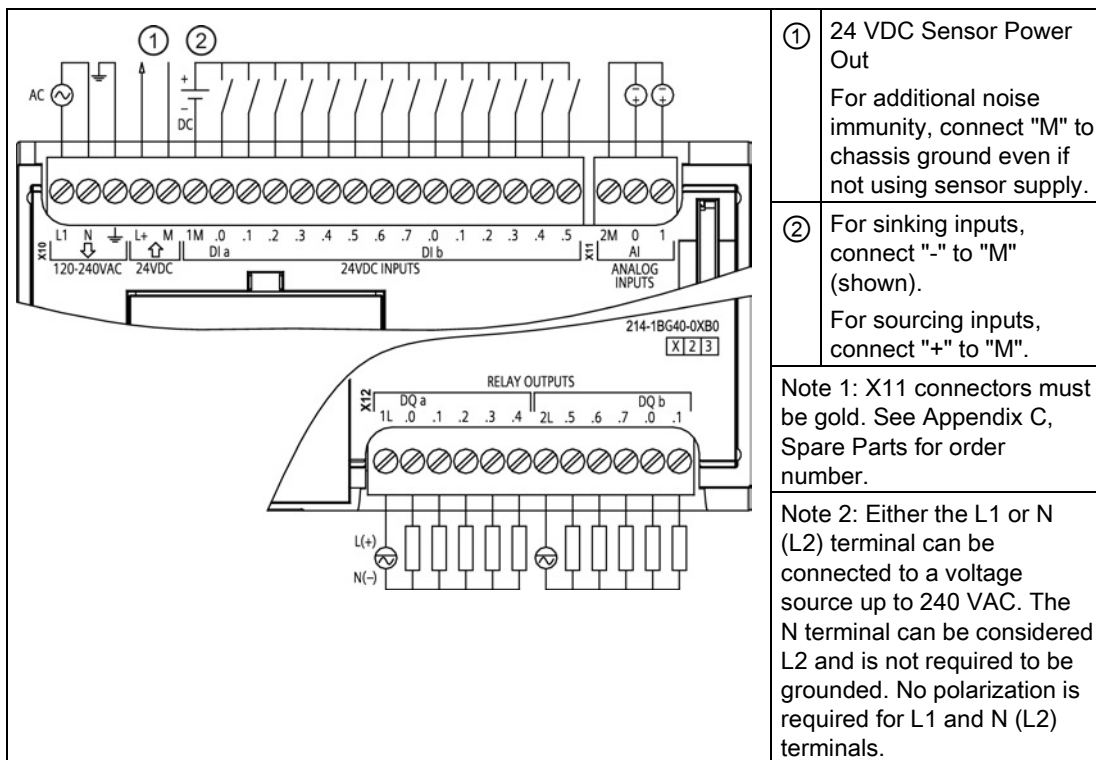

Table A- 61 Connector pin locations for CPU 1214C AC/DC/Relay (6ES7 214-1BG40-0XB0)

| Pin | X10 | X11 (gold) | X12 |
|-----|------------------------|------------|--------|
| 1 | L1 / 120-240 VAC | 2 M | 1L |
| 2 | N / 120-240 VAC | AI 0 | DQ a.0 |
| 3 | Functional Earth | AI 1 | DQ a.1 |
| 4 | L+ / 24 VDC Sensor Out | -- | DQ a.2 |
| 5 | M / 24 VDC Sensor Out | -- | DQ a.3 |
| 6 | 1M | -- | DQ a.4 |
| 7 | DI a.0 | -- | 2L |
| 8 | DI a.1 | -- | DQ a.5 |
| 9 | DI a.2 | -- | DQ a.6 |
| 10 | DI a.3 | -- | DQ a.7 |
| 11 | DI a.4 | -- | DQ b.0 |
| 12 | DI a.5 | -- | DQ b.1 |
| 13 | DI a.6 | -- | -- |
| 14 | DI a.7 | -- | -- |
| 15 | DI b.0 | -- | -- |
| 16 | DI b.1 | -- | -- |

| Pin | X10 | X11 (gold) | X12 |
|-----|--------|------------|-----|
| 17 | DI b.2 | -- | -- |
| 18 | DI b.3 | -- | -- |
| 19 | DI b.4 | -- | -- |
| 20 | DI b.5 | -- | -- |

Table A- 62 CPU 1214C DC/DC/Relay (6ES7 214-1HG40-0XB0)

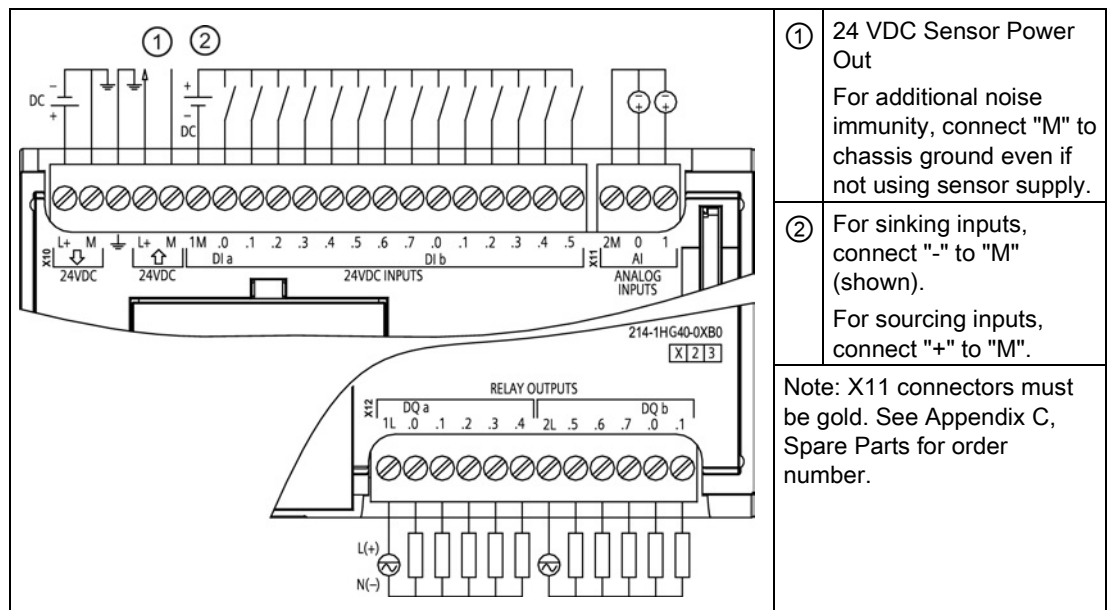
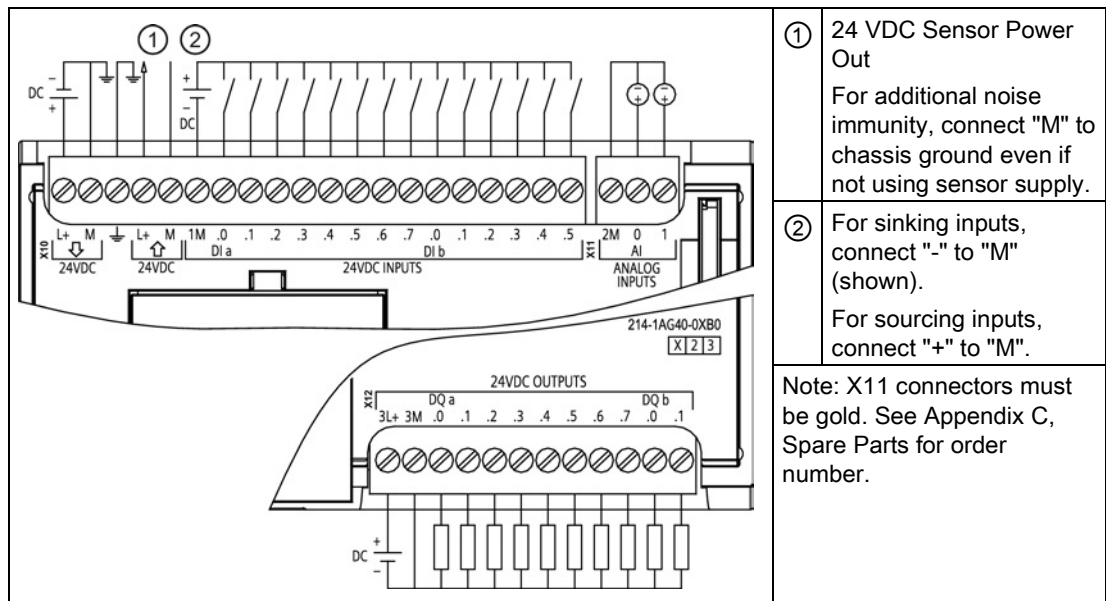

Table A- 63 Connector pin locations for CPU 1214C DC/DC/Relay (6ES7 214-1HG40-0XB0)

| Pin | X10 | X11 (gold) | X12 |
|-----|------------------------|------------|--------|
| 1 | L+ / 24 VDC | 2 M | 1L |
| 2 | M / 24 VDC | AI 0 | DQ a.0 |
| 3 | Functional Earth | AI 1 | DQ a.1 |
| 4 | L+ / 24 VDC Sensor Out | -- | DQ a.2 |
| 5 | M / 24 VDC Sensor Out | -- | DQ a.3 |
| 6 | 1M | -- | DQ a.4 |
| 7 | DI a.0 | -- | 2L |
| 8 | DI a.1 | -- | DQ a.5 |
| 9 | DI a.2 | -- | DQ a.6 |
| 10 | DI a.3 | -- | DQ a.7 |
| 11 | DI a.4 | -- | DQ b.0 |
| 12 | DI a.5 | -- | DQ b.1 |
| 13 | DI a.6 | -- | -- |
| 14 | DI a.7 | -- | -- |

| Pin | X10 | X11 (gold) | X12 |
|-----|--------|------------|-----|
| 15 | DI b.0 | -- | -- |
| 16 | DI b.1 | -- | -- |
| 17 | DI b.2 | -- | -- |
| 18 | DI b.3 | -- | -- |
| 19 | DI b.4 | -- | -- |
| 20 | DI b.5 | -- | -- |

Table A- 64 CPU 1214C DC/DC/DC (6ES7 214-1AG40-0XB0)



- ① 24 VDC Sensor Power Out
For additional noise immunity, connect "M" to chassis ground even if not using sensor supply.
- ② For sinking inputs, connect "-" to "M" (shown).
For sourcing inputs, connect "+" to "M".

Note: X11 connectors must be gold. See Appendix C, Spare Parts for order number.

Table A- 65 Connector pin locations for CPU 1214C DC/DC/DC (6ES7 214-1AG40-0XB0)

| Pin | X10 | X11 (gold) | X12 |
|-----|------------------------|------------|--------|
| 1 | L+ / 24 VDC | 2 M | 3L+ |
| 2 | M / 24 VDC | AI 0 | 3M |
| 3 | Functional Earth | AI 1 | DQ a.0 |
| 4 | L+ / 24 VDC Sensor Out | -- | DQ a.1 |
| 5 | M / 24 VDC Sensor Out | -- | DQ a.2 |
| 6 | 1M | -- | DQ a.3 |
| 7 | DI a.0 | -- | DQ a.4 |
| 8 | DI a.1 | -- | DQ a.5 |
| 9 | DI a.2 | -- | DQ a.6 |
| 10 | DI a.3 | -- | DQ a.7 |
| 11 | DI a.4 | -- | DQ b.0 |
| 12 | DI a.5 | -- | DQ b.1 |
| 13 | DI a.6 | -- | -- |

| Pin | X10 | X11 (gold) | X12 |
|-----|--------|------------|-----|
| 14 | DI a.7 | -- | - |
| 15 | DI b.0 | -- | -- |
| 16 | DI b.1 | -- | -- |
| 17 | DI b.2 | -- | -- |
| 18 | DI b.3 | -- | -- |
| 19 | DI b.4 | -- | -- |
| 20 | DI b.5 | -- | -- |

Note

Unused analog inputs should be shorted.

A.5 CPU 1215C

A.5.1 General specifications and features

Table A- 66 General

| Technical data | CPU 1215C AC/DC/Relay | CPU 1215C DC/DC/Relay | CPU 1215C DC/DC/DC |
|---|-------------------------------|-------------------------------|-------------------------------|
| Order number | 6ES7 215-1BG40-0XB0 | 6ES7 215-1HG40-0XB0 | 6ES7 215-1AG40-0XB0 |
| Dimensions W x H x D (mm) | 130 x 100 x 75 | 130 x 100 x 75 | 130 x 100 x 75 |
| Shipping weight | 585 grams | 550 grams | 520 grams |
| Power dissipation | 14 W | 12 W | 12 W |
| Current available (SM and CM bus) | 1600 mA max. (5 VDC) | 1600 mA max. (5 VDC) | 1600 mA max. (5 VDC) |
| Current available (24 VDC) | 400 mA max. (sensor power) | 400 mA max. (sensor power) | 400 mA max. (sensor power) |
| Digital input current consumption (24 VDC) | 4 mA/input used | 4 mA/input used | 4 mA/input used |

Table A- 67 CPU features

| Technical data | Description |
|----------------------|-------------|
| User memory | Work |
| | Load |
| | Retentive |
| On-board digital I/O | |

A.5 CPU 1215C

| Technical data | Description |
|--------------------------------|---|
| On-board analog I/O | 2 inputs/2 outputs |
| Process image size | 1024 bytes of inputs (I)/1024 bytes of outputs (Q) |
| Bit memory (M) | 8192 bytes |
| Temporary (local) memory | <ul style="list-style-type: none"> • 16 Kbytes for startup and program cycle (including associated FBs and FCs) • 6 Kbytes for each of the other interrupt priority levels (including FBs and FCs) |
| Signal modules expansion | 8 SMs max. |
| SB, CB, BB expansion | 1 max. |
| Communication module expansion | 3 CMs max. |
| High-speed counters | Up to 6 configured to use any built-in or SB inputs. See table CPU 1215C: HSC default address assignments <ul style="list-style-type: none"> • 100/180 kHz (Ia.0 to Ia.5) • 30/120 kHz (Ia.6 to Ib.5) |
| Pulse outputs ² | Up to 4 configured to use any built-in or SB outputs <ul style="list-style-type: none"> • 100 kHz (Qa.0 to Qa.3) • 30 kHz (Qa.4 to Qb.1) |
| Pulse catch inputs | 14 |
| Time delay interrupts | 4 total with 1 ms resolution |
| Cyclic interrupts | 4 total with 1 ms resolution |
| Edge interrupts | 12 rising and 12 falling (16 and 16 with optional signal board) |
| Memory card | SIMATIC Memory Card (optional) |
| Real time clock accuracy | +/- 60 seconds/month |
| Real time clock retention time | 20 days typ./12 days min. at 40 °C (maintenance-free Super Capacitor) |

¹ The slower speed is applicable when the HSC is configured for quadrature mode of operation.

² For CPU models with relay outputs, you must install a digital signal board (SB) to use the pulse outputs.

Table A- 68 Performance

| Type of instruction | Execution speed |
|---------------------|---------------------|
| Boolean | 0.08 µs/instruction |
| Move Word | 1.7 µs/instruction |
| Real math | 2.3 µs/instruction |

A.5.2 Timers, counters and code blocks supported by CPU 1215C

Table A- 69 Blocks, timers and counters supported by CPU 1215C

| Element | Description | |
|-----------------------------|-------------------------------------|---|
| Blocks | Type | OB, FB, FC, DB |
| | Size | 64 Kbytes |
| | Quantity | Up to 1024 blocks total (OBs + FBs + FCs + DBs) |
| | Address range for FBs, FCs, and DBs | FB and FC: 1 to 65535 (such as FB 1 to FB 65535) DB: 1 to 59999 |
| | Nesting depth | 16 from the program cycle or startup OB 6 from any interrupt event OB |
| | Monitoring | Status of 2 code blocks can be monitored simultaneously |
| | OBs | Program cycle |
| Startup | | Multiple |
| Time-delay interrupts | | 4 (1 per event) |
| Cyclic interrupts | | 4 (1 per event) |
| Hardware interrupts | | 50 (1 per event) |
| Time error interrupts | | 1 |
| Diagnostic error interrupts | | 1 |
| Pull or plug of modules | | 1 |
| Rack or station failure | | 1 |
| Time of day | | Multiple |
| Status | | 1 |
| Update | | 1 |
| Profile | | 1 |
| Timers | Type | IEC |
| | Quantity | Limited only by memory size |
| | Storage | Structure in DB, 16 bytes per timer |
| Counters | Type | IEC |
| | Quantity | Limited only by memory size |
| | Storage | Structure in DB, size dependent upon count type <ul style="list-style-type: none"> • SInt, USInt: 3 bytes • Int, UInt: 6 bytes • DInt, UDInt: 12 bytes |

A.5 CPU 1215C

Table A- 70 Communication

| Technical data | Description |
|--|--|
| Number of ports | 2 |
| Type | Ethernet |
| HMI device | 3 |
| Programming device (PG) | 1 |
| Connections | <ul style="list-style-type: none"> • 8 for Open User Communication (active or passive): TSEND_C, TRCV_C, TCON, TDISCON, TSEND, and TRCV • 3 for server GET/PUT (CPU-to-CPU) S7 communication • 8 for client GET/PUT (CPU-to-CPU) S7 communication |
| Data rates | 10/100 Mb/s |
| Isolation (external signal to PLC logic) | Transformer isolated, 1500 VAC, for short term event safety only |
| Cable type | CAT5e shielded |

Table A- 71 Power supply

| Technical data | CPU 1215C AC/DC/Relay | CPU 1215C DC/DC/Relay | CPU 1215C DC/DC/DC |
|---|------------------------------------|--|-----------------------|
| Voltage range | 85 to 264 VAC | 20.4 VDC to 28.8 VDC | |
| Line frequency | 47 to 63 Hz | -- | |
| Input current (max. load) | CPU only | 100 mA at 120 VAC 50 mA at 240 VAC | 500 mA at 24 VDC |
| | CPU with all expansion accessories | 300 mA at 120 VAC 150 mA at 240 VAC | 1500 mA at 24 VDC |
| Inrush current (max.) | 20 A at 264 VAC | 12 A at 28.8 VDC | |
| Isolation (input power to logic) | 1500 VAC | Not isolated | |
| Ground leakage, AC line to functional earth | 0.5 mA max. | - | |
| Hold up time (loss of power) | 20 ms at 120 VAC | 10 ms at 24 VDC | |
| | 80 ms at 240 VAC | | |
| Internal fuse, not user replaceable | 3 A, 250 V, slow blow | | |

Table A- 72 Sensor power

| Technical data | CPU 1215C AC/DC/Relay | CPU 1215C DC/DC/Relay | CPU 1215C DC/DC/DC |
|---------------------------------------|----------------------------------|--------------------------|-----------------------|
| Voltage range | 20.4 to 28.8 VDC | L+ minus 4 VDC min. | |
| Output current rating (max.) | 400 mA (short-circuit protected) | | |
| Maximum ripple noise (<10 MHz) | < 1 V peak to peak | Same as input line | |
| Isolation (CPU logic to sensor power) | Not isolated | | |

A.5.3 Digital inputs and outputs

Table A- 73 Digital inputs

| Technical data | CPU 1215C AC/DC/Relay | CPU 1215C DC/DC/Relay | CPU 1215C DC/DC/DC |
|--|--|--------------------------|-----------------------|
| Number of inputs | 14 | | |
| Type | Sink/Source (IEC Type 1 sink) | | |
| Rated voltage | 24 VDC at 4 mA, nominal | | |
| Continuous permissible voltage | 30 VDC, max. | | |
| Surge voltage | 35 VDC for 0.5 sec. | | |
| Logic 1 signal (min.) | 15 VDC at 2.5 mA | | |
| Logic 0 signal (max.) | 5 VDC at 1 mA | | |
| Isolation (field side to logic) | 500 VAC for 1 minute | | |
| Isolation groups | 1 | | |
| Filter times | us settings: 0.1, 0.2, 0.4, 0.8, 1.6, 3.2, 6.4, 10.0, 12.8, 20.0 ms settings: 0.05, 0.1, 0.2, 0.4, 0.8, 1.6, 3.2, 6.4, 10.0, 12.8, 20.0 | | |
| HSC clock input rates (max.) (Logic 1 Level = 15 to 26 VDC) | 100/80 kHz (Ia.0 to Ia.5) 30/20 kHz (Ia.6 to Ib.5) | | |
| Number of inputs on simultaneously | <ul style="list-style-type: none"> • 7 (no adjacent points) at 60 °C horizontal or 50 °C vertical • 14 at 55 °C horizontal or 45 °C vertical | | |
| Cable length (meters) | 500 m shielded, 300 m unshielded, 50 m shielded for HSC inputs | | |

Table A- 74 Digital outputs

| Technical data | CPU 1215C AC/DC/Relay and CPU 1215C DC/DC/Relay | CPU 1215C DC/DC/DC |
|--|---|---------------------------------|
| Number of outputs | 10 | 10 |
| Type | Relay, dry contact | Solid state - MOSFET (sourcing) |
| Voltage range | 5 to 30 VDC or 5 to 250 VAC | 20.4 to 28.8 VDC |
| Logic 1 signal at max. current | -- | 20 VDC min. |
| Logic 0 signal with 10 K Ω load | -- | 0.1 VDC max. |
| Current (max.) | 2.0 A | 0.5 A |
| Lamp load | 30 W DC / 200 W AC | 5 W |
| ON state resistance | 0.2 Ω max. when new | 0.6 Ω max. |
| Leakage current per point | -- | 10 μ A max. |
| Surge current | 7 A with contacts closed | 8 A for 100 ms max. |
| Overload protection | No | No |
| Isolation (field side to logic) | 1500 VAC for 1 minute (coil to contact) None (coil to logic) | 500 VAC for 1 minute |
| Isolation resistance | 100 M Ω min. when new | -- |
| Isolation between open contacts | 750 VAC for 1 minute | -- |

A.5 CPU 1215C

| Technical data | CPU 1215C AC/DC/Relay and CPU 1215C DC/DC/Relay | CPU 1215C DC/DC/DC |
|-------------------------------------|--|---|
| Isolation groups | 2 | 1 |
| Inductive clamp voltage | -- | L+ minus 48 VDC, 1 W dissipation |
| Switching delay (Qa.0 to Qa.3) | 10 ms max. | 1.0 µs max., off to on 3.0 µs max., on to off |
| Switching delay (Qa.4 to Qb.1) | 10 ms max. | 50 µs max., off to on 200 µs max., on to off |
| Maximum relay switching frequency | 1 Hz | -- |
| Pulse Train Output rate | Not recommended ¹ | 100 kHz (Qa.0 to Qa.3) ² , 2 Hz min. 20 kHz (Qa.4 to Qb.1) ² |
| Lifetime mechanical (no load) | 10,000,000 open/close cycles | -- |
| Lifetime contacts at rated load | 100,000 open/close cycles | -- |
| Behavior on RUN to STOP | Last value or substitute value (default value 0) | |
| Number of outputs on simultaneously | <ul style="list-style-type: none"> • 5 (no adjacent points) at 60 °C horizontal or 50 °C vertical • 10 at 55 °C horizontal or 45 °C vertical | |
| Cable length (meters) | 500 m shielded, 150 m unshielded | |

¹ For CPU models with relay outputs, you must install a digital signal board (SB) to use the pulse outputs.

² Depending on your pulse receiver and cable, an additional load resistor (at least 10% of rated current) may improve pulse signal quality and noise immunity.

A.5.4 Analog inputs and outputs

Table A- 75 Analog inputs

| Technical data | Description |
|---------------------------------|---|
| Number of inputs | 2 |
| Type | Voltage (single-ended) |
| Full-scale range | 0 to 10 V |
| Full-scale range (data word) | 0 to 27648 |
| Overshoot range | 10.001 to 11.759 V |
| Overshoot range (data word) | 27649 to 32511 |
| Overflow range | 11.760 to 11.852 V |
| Overflow range (data word) | 32512 to 32767 |
| Resolution | 10 bits |
| Maximum withstand voltage | 35 VDC |
| Smoothing | None, Weak, Medium, or Strong See the table for step response (ms) for the analog inputs of the CPU. |
| Noise rejection | 10, 50, or 60 Hz |
| Impedance | ≥100 KΩ |
| Isolation (field side to logic) | None |

| Technical data | Description |
|-------------------------------|------------------------------|
| Accuracy (25 °C / 0 to 55 °C) | 3.0% / 3.5% of full-scale |
| Cable length (meters) | 100 m, shielded twisted pair |

A.5.4.1 Step response of built-in analog inputs of the CPU

Table A- 76 Step Response (ms), 0 V to 10 V measured at 95%

| Smoothing selection (sample averaging) | Rejection frequency (Integration time) | | |
|--|--|-------------|--------------|
| | 60 Hz | 50 Hz | 10 Hz |
| None (1 cycle): No averaging | 50 ms | 50 ms | 100 ms |
| Weak (4 cycles): 4 samples | 60ms | 70 ms | 200 ms |
| Medium (16 cycles): 16 samples | 200 ms | 240 ms | 1150 ms |
| Strong (32 cycles): 32 samples | 400 ms | 480 ms | 2300 ms |
| Sample time | 4.17 ms | 5 ms | 25 ms |

A.5.4.2 Sample time for the built-in analog ports of the CPU

Table A- 77 Sample time for built-in analog inputs of the CPU

| Rejection frequency (Integration time selection) | Sample time |
|--|-------------|
| 60 Hz (16.6 ms) | 4.17 ms |
| 50 Hz (20 ms) | 5 ms |
| 10 Hz (100 ms) | 25 ms |

A.5.4.3 Measurement ranges of the analog inputs for voltage (CPUs)

Table A- 78 Analog input representation for voltage (CPUs)

| System | | Voltage Measuring Range | |
|-----------------|-------------|-----------------------------------|-----------------|
| Decimal | Hexadecimal | 0 to 10 V | |
| 32767 | 7FFF | 11.851 V | Overflow |
| 32512 | 7F00 | | |
| 32511 | 7EFF | 11.759 V | Overshoot range |
| 27649 | 6C01 | | |
| 27648 | 6C00 | 10 V | Rated range |
| 20736 | 5100 | 7.5 V | |
| 34 | 22 | 12 mV | |
| 0 | 0 | 0 V | |
| Negative values | | Negative values are not supported | |

A.5.4.4 Analog output specifications

Analog outputs

Table A- 79 Analog outputs

| Technical data | Description |
|---------------------------------|------------------------------|
| Number of outputs | 2 |
| Type | Current |
| Full-scale range | 0 to 20 mA |
| Full-scale range (data word) | 0 to 27648 |
| Overshoot range | 20.01 to 23.52 mA |
| Overshoot range (data word) | 27649 to 32511 |
| Overflow range | see footnote ¹ |
| Overflow range data word | 32512 to 32767 |
| Resolution | 10 bits |
| Output drive impedance | ≤500 Ω max. |
| Isolation (field side to logic) | None |
| Accuracy (25 °C / -20 to 60 °C) | 3.0% / 3.5% of full-scale |
| Settling time | 2 ms |
| Cable length (meters) | 100 m, shielded twisted pair |

¹ In an overflow condition, analog outputs will behave according to the device configuration properties settings. In the "Reaction to CPU STOP" parameter, select either: "Use substitute value" or "Keep last value".

Table A- 80 Analog output representation for current (CPU 1215C and CPU 1217C)

| System | | Current output range | |
|-----------------|-------------|-----------------------------------|-----------------|
| Decimal | Hexadecimal | 0 mA to 20 mA | |
| 32767 | 7FFF | See note 1 | Overflow |
| 32512 | 7F00 | See note 1 | |
| 32511 | 7EFF | 23.52 mA | Overshoot range |
| 27649 | 6C01 | | |
| 27648 | 6C00 | 20 mA | Rated range |
| 20736 | 5100 | 15 mA | |
| 34 | 22 | 12 mV | |
| 0 | 0 | 0 mA | |
| Negative values | | Negative values are not supported | |

¹ In an overflow condition, analog outputs will behave according to the device configuration properties settings. In the "Reaction to CPU STOP" parameter, select either: "Use substitute value" or "Keep last value".

A.5.5 CPU 1215C wiring diagrams

Table A- 81 CPU 1215C AC/DC/Relay (6ES7 215-1BG40-0XB0)

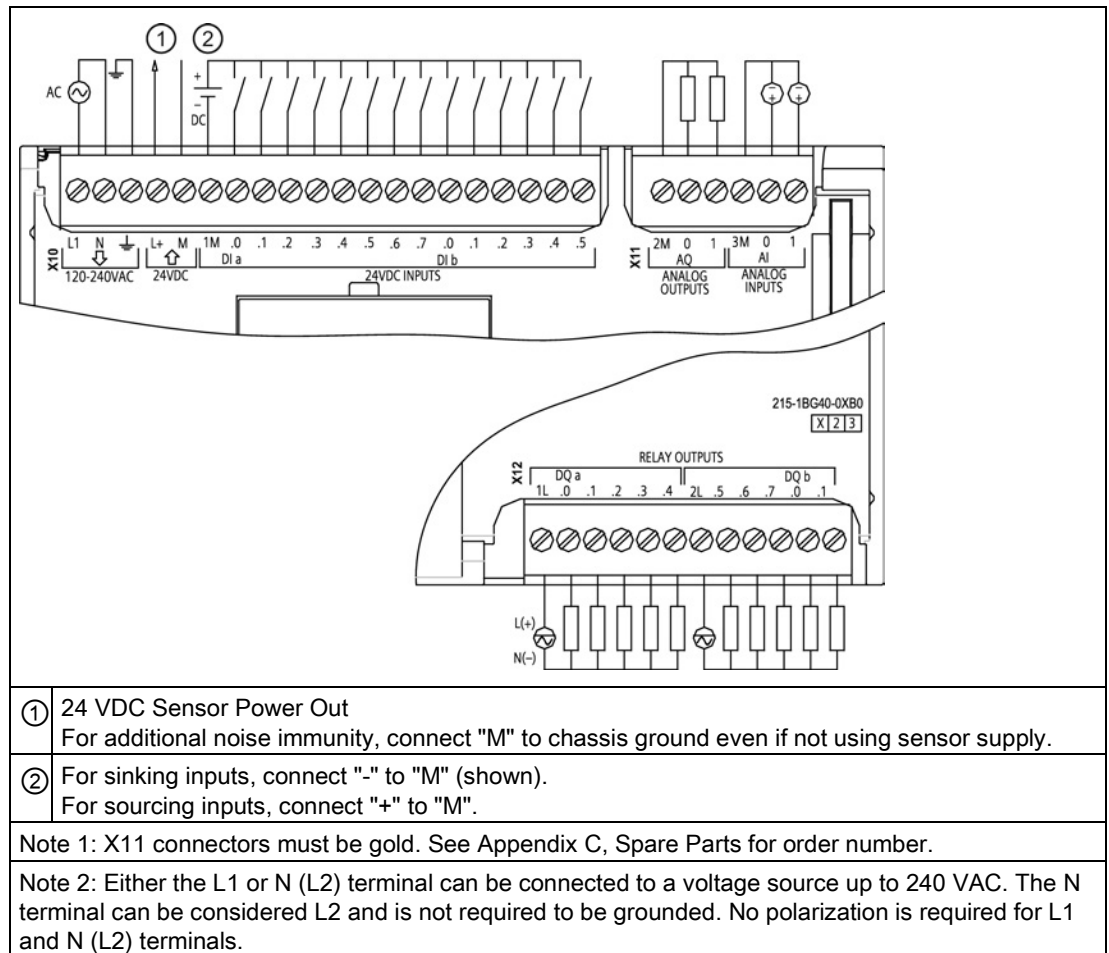

Table A- 82 Connector pin locations for CPU 1215C AC/DC/Relay (6ES7 215-1BG40-0XB0)

| Pin | X10 | X11 (gold) | X12 |
|-----|------------------------|------------|--------|
| 1 | L1 /120-240 VAC | 2 M | 1L |
| 2 | N / 120 - 240 VAC | AQ 0 | DQ a.0 |
| 3 | Functional Earth | AQ 1 | DQ a.1 |
| 4 | L+ / 24 VDC Sensor Out | 3M | DQ a.2 |
| 5 | M / 24 VDC Sensor Out | AI 0 | DQ a.3 |
| 6 | 1M | AI 1 | DQ a.4 |
| 7 | DI a.0 | -- | 2L |
| 8 | DI a.1 | -- | DQ a.5 |
| 9 | DI a.2 | -- | DQ a.6 |
| 10 | DI a.3 | -- | DQ a.7 |
| 11 | DI a.4 | -- | DQ b.0 |

| Pin | X10 | X11 (gold) | X12 |
|-----|--------|------------|--------|
| 12 | DI a.5 | -- | DQ b.1 |
| 13 | DI a.6 | -- | -- |
| 14 | DI a.7 | -- | -- |
| 15 | DI b.0 | -- | -- |
| 16 | DI b.1 | -- | -- |
| 17 | DI b.2 | -- | -- |
| 18 | DI b.3 | -- | -- |
| 19 | DI b.4 | -- | -- |
| 20 | DI b.5 | -- | -- |

Table A- 83 CPU 1215C DC/DC/Relay (6ES7 215-1HG40-0XB0)

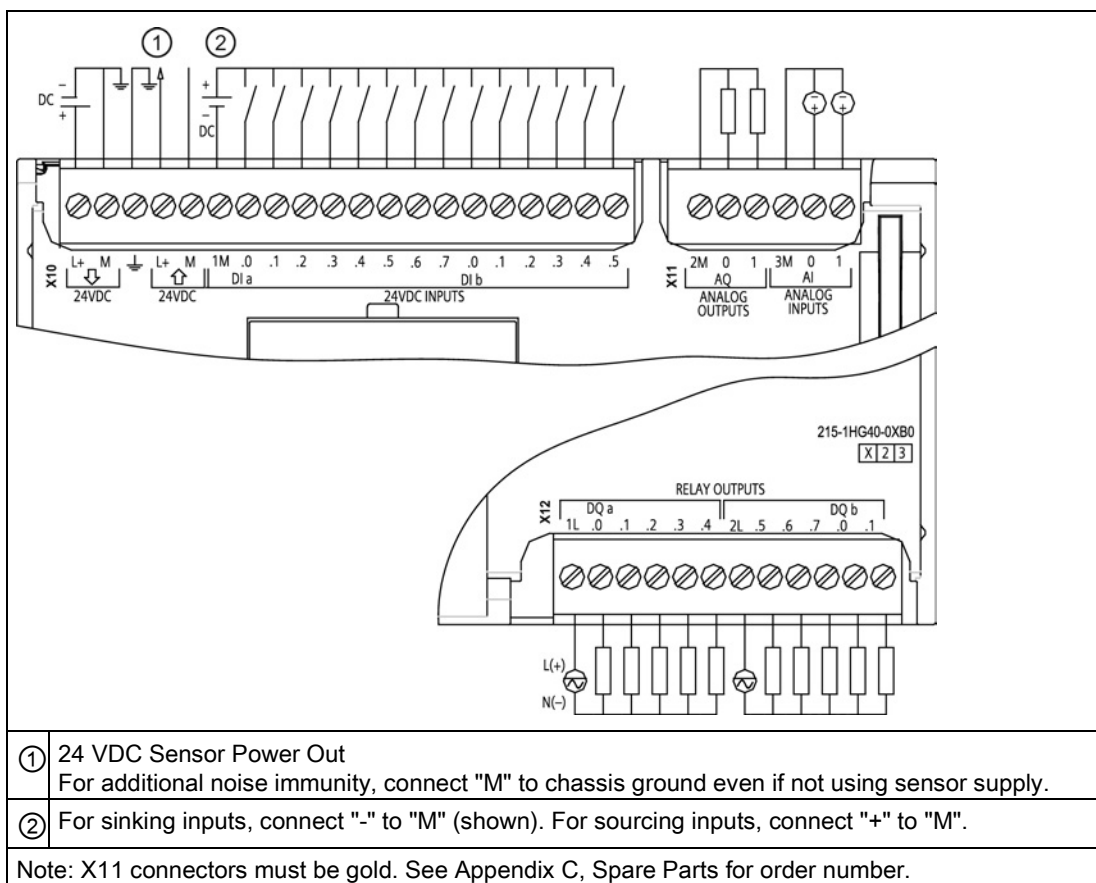

Table A- 84 Connector pin locations for CPU 1215C DC/DC/Relay (6ES7 215-1HG40-0XB0)

| Pin | X10 | X11 (gold) | X12 |
|-----|------------------------|------------|--------|
| 1 | L+ / 24 VDC | 2 M | 1L |
| 2 | M / 24 VDC | AQ 0 | DQ a.0 |
| 3 | Functional Earth | AQ 1 | DQ a.1 |
| 4 | L+ / 24 VDC Sensor Out | 3M | DQ a.2 |
| 5 | M / 24 VDC Sensor Out | AI 0 | DQ a.3 |
| 6 | 1M | AI 1 | DQ a.4 |
| 7 | DI a.0 | -- | 2L |
| 8 | DI a.1 | -- | DQ a.5 |
| 9 | DI a.2 | -- | DQ a.6 |
| 10 | DI a.3 | -- | DQ a.7 |
| 11 | DI a.4 | -- | DQ b.0 |
| 12 | DI a.5 | -- | DQ b.1 |
| 13 | DI a.6 | -- | -- |
| 14 | DI a.7 | -- | -- |
| 15 | DI b.0 | -- | -- |
| 16 | DI b.1 | -- | -- |
| 17 | DI b.2 | -- | -- |
| 18 | DI b.3 | -- | -- |
| 19 | DI b.4 | -- | -- |
| 20 | DI b.5 | -- | -- |

Table A- 85 CPU 1215C DC/DC/DC (6ES7 215-1AG40-0XB0)

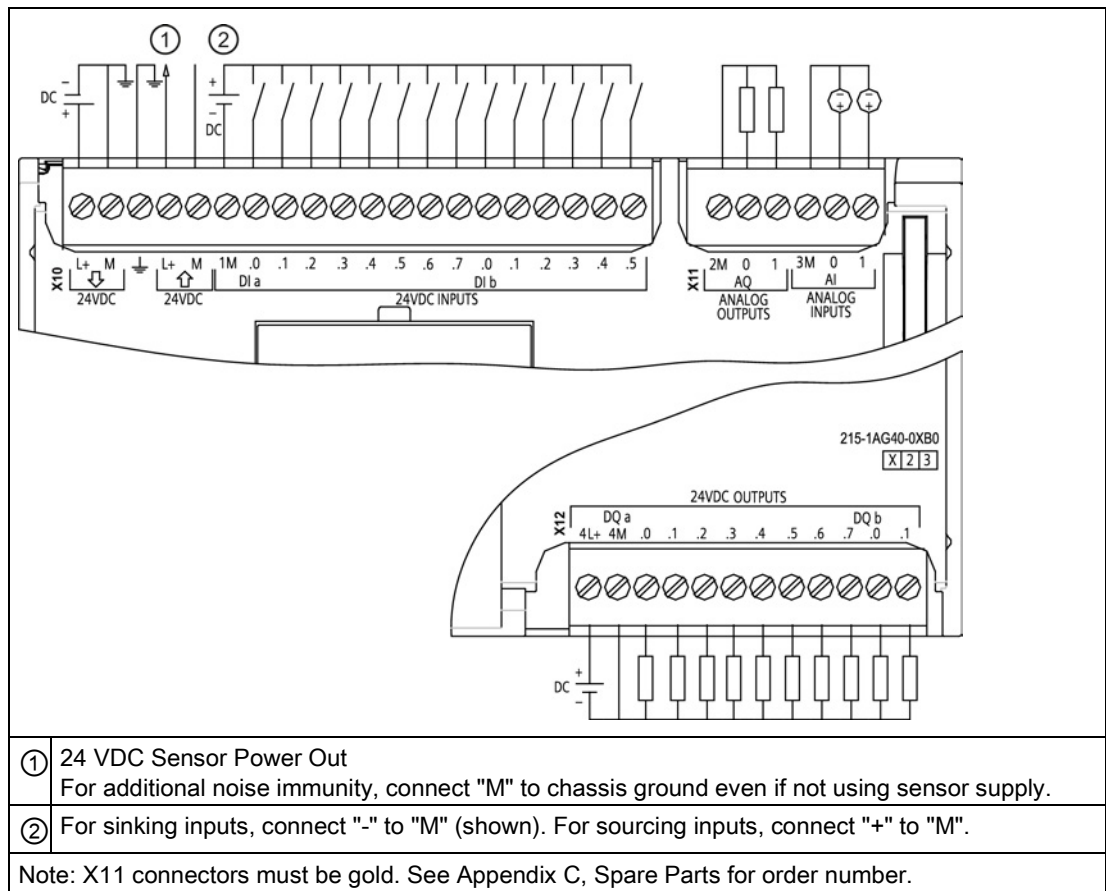

Table A- 86 Connector pin locations for CPU 1215C DC/DC/DC (6ES7 215-1AG40-0XB0)

| Pin | X10 | X11 (gold) | X12 |
|-----|------------------------|------------|--------|
| 1 | L1 / 24 VDC | 2 M | 4L+ |
| 2 | M / 24 VDC | AQ 0 | 4M |
| 3 | Functional Earth | AQ 1 | DQ a.0 |
| 4 | L+ / 24 VDC Sensor Out | 3M | DQ a.1 |
| 5 | M / 24 VDC Sensor Out | AI 0 | DQ a.2 |
| 6 | 1M | AI 1 | DQ a.3 |
| 7 | DI a.0 | -- | DQ a.4 |
| 8 | DI a.1 | -- | DQ a.5 |
| 9 | DI a.2 | -- | DQ a.6 |
| 10 | DI a.3 | -- | DQ a.7 |
| 11 | DI a.4 | -- | DQ b.0 |
| 12 | DI a.5 | -- | DQ b.1 |
| 13 | DI a.6 | -- | -- |
| 14 | DI a.7 | -- | -- |

| Pin | X10 | X11 (gold) | X12 |
|-----|--------|------------|-----|
| 15 | DI b.0 | -- | -- |
| 16 | DI b.1 | -- | -- |
| 17 | DI b.2 | -- | -- |
| 18 | DI b.3 | -- | -- |
| 19 | DI b.4 | -- | -- |
| 20 | DI b.5 | -- | -- |

Note

Unused analog inputs should be shorted.

A.6 CPU 1217C

A.6.1 General specifications and features

Table A- 87 General

| Technical data | CPU 1217C DC/DC/DC |
|--|----------------------------|
| Order number | 6ES7 217-1AG40-0XB0 |
| Dimensions W x H x D (mm) | 150 x 100 x 75 |
| Shipping weight | 530 grams |
| Power dissipation | 12 W |
| Current available (SM and CM bus) | 1600 mA max. (5 VDC) |
| Current available (24 VDC) | 400 mA max. (sensor power) |
| Digital input current consumption (24 VDC) | 4 mA/input used |

Table A- 88 CPU features

| Technical data | Description | |
|----------------------|--|---|
| User memory | Work | 125 Kbytes |
| | Load | 4 Mbytes, internal, expandable up to SD card size |
| | Retentive | 10 Kbytes |
| On-board digital I/O | 14 inputs/ 10 outputs | |
| On-board analog I/O | 2 inputs/ 2 outputs | |
| Process image size | 1024 bytes of inputs (I) / 1024 bytes of outputs (Q) | |
| Bit memory (M) | 8192 bytes | |

A.6 CPU 1217C

| Technical data | Description |
|--------------------------------|--|
| Temporary (local) memory | <ul style="list-style-type: none"> • 16 Kbytes for startup and program cycle (including associated FBs and FCs) • 6 Kbytes for each of the other interrupt priority levels (including FBs and FCs) |
| Signal modules expansion | 8 SMs max. |
| SB, CB, BB expansion | 1 max. |
| Communication module expansion | 3 CMs max. |
| High-speed counters | Up to 6 configured to use any built-in or SB inputs (refer to CPU 1217C Digital input (DI) H/W configuration table) (Page 882) <ul style="list-style-type: none"> • 1 MHz (Ib.2 to Ib.5) • 100/180 kHz (Ia.0 to Ia.5) • 30/120 kHz (Ia.6 to Ib.1) |
| Pulse outputs | Up to 4 configured to use any built-in or SB outputs (refer to CPU 1217C Digital output (DQ) H/W configuration table) (Page 882) <ul style="list-style-type: none"> • 1 MHz (Qa.0 to Qa.3) • 100 kHz (Qa.4 to Qb.1) |
| Pulse catch inputs | 14 |
| Time delay interrupts | 4 total with 1 ms resolution |
| Cyclic interrupts | 4 total with 1 ms resolution |
| Edge interrupts | 12 rising and 12 falling (16 and 16 with optional signal board) |
| Memory card | SIMATIC Memory Card (optional) |
| Real time clock accuracy | +/- 60 seconds/month |
| Real time clock retention time | 20 days typ./12 days min. at 40 °C (maintenance-free Super Capacitor) |

¹ The slower speed is applicable when the HSC is configured for quadrature mode of operation.

Table A- 89 Performance

| Type of instruction | Execution speed |
|---------------------|---------------------|
| Boolean | 0.08 µs/instruction |
| Move Word | 1.7 µs/instruction |
| Real math | 2.3 µs/instruction |

A.6.2 Timers, counters and code blocks supported by CPU 1217C

Table A- 90 Blocks, timers and counters supported by CPU 1217C

| Element | Description | |
|---------|-------------------------------------|--|
| Blocks | Type | OB, FB, FC, DB |
| | Size | 64 Kbytes |
| | Quantity | Up to 1024 blocks total (OBs + FBs + FCs + DBs) |
| | Address range for FBs, FCs, and DBs | FB and FC: 1 to 65535 (such as FB 1 to FB 65535) DB: 1 to 59999 |

| Element | Description | |
|----------|-----------------------------|---|
| | Nesting depth | 16 from the program cycle or startup OB 6 from any interrupt event OB |
| | Monitoring | Status of 2 code blocks can be monitored simultaneously |
| OBs | Program cycle | Multiple |
| | Startup | Multiple |
| | Time-delay interrupts | 4 (1 per event) |
| | Cyclic interrupts | 4 (1 per event) |
| | Hardware interrupts | 50 (1 per event) |
| | Time error interrupts | 1 |
| | Diagnostic error interrupts | 1 |
| | Pull or plug of modules | 1 |
| | Rack or station failure | 1 |
| | Time of day | Multiple |
| | Status | 1 |
| | Update | 1 |
| | Profile | 1 |
| Timers | Type | IEC |
| | Quantity | Limited only by memory size |
| | Storage | Structure in DB, 16 bytes per timer |
| Counters | Type | IEC |
| | Quantity | Limited only by memory size |
| | Storage | Structure in DB, size dependent upon count type <ul style="list-style-type: none"> • SInt, USInt: 3 bytes • Int, UInt: 6 bytes • DInt, UDInt: 12 bytes |

Table A- 91 Communication

| Technical data | Description |
|--|--|
| Number of ports | 2 |
| Type | Ethernet |
| HMI device | 6 max. |
| Programming device (PG) | 1 |
| Connections | <ul style="list-style-type: none"> • 8 for Open User Communication (active or passive): TSEND_C, TRCV_C, TCON, TDISCON, TSEND, and TRCV • 3 for server GET/PUT (CPU-to-CPU) S7 communication • 8 for client GET/PUT (CPU-to-CPU) S7 communication |
| Data rates | 10/100 Mb/s |
| Isolation (external signal to PLC logic) | Transformer isolated, 1500 VAC, for short term event safety only |
| Cable type | CAT5e shielded |

A.6 CPU 1217C

Table A- 92 Power supply

| Technical data | | CPU 1217C DC/DC/DC |
|-------------------------------------|------------------------------------|-----------------------|
| Voltage range | | 20.4 VDC to 28.8 VDC |
| Line frequency | | -- |
| Input current (max. load) | CPU only | 600 mA at 24 VDC |
| | CPU with all expansion accessories | 1600 mA at 24 VDC |
| Inrush current (max.) | | 12 A at 28.8 VDC |
| Isolation (input power to logic) | | Not isolated |
| Hold up time (from loss of power) | | 10 ms at 24 VDC |
| Internal fuse, not user replaceable | | 3 A, 250 V, slow blow |

Table A- 93 Sensor power

| Technical data | | CPU 1217C DC/DC/DC |
|---------------------------------------|--|----------------------------------|
| Voltage range | | L+ minus 4 VDC min. |
| Output current rating (max.) | | 400 mA (short-circuit protected) |
| Maximum ripple noise (<10 MHz) | | Same as input line |
| Isolation (CPU logic to sensor power) | | Not isolated |

A.6.3 Digital inputs and outputs

Table A- 94 Digital inputs

| Technical data | | CPU 1217C DC/DC/DC |
|--|--|--|
| Number of inputs | | 14: total: 10: Sink/source (IEC Type 1 sink) 4: 1.5 V differential |
| Type: Sink/source (IEC Type 1 sink) | | Ia.0 to Ia.7, Ib.0 to Ib.1 |
| Rated voltage | | 24 VDC at 4 mA, nominal |
| Continuous permissible voltage | | 30 VDC, max. |
| Surge voltage | | 35 VDC for 0.5 sec. |
| Logic 1 signal (min.) | | 15 VDC at 2.5 mA |
| Logic 0 signal (max.) | | 5 VDC at 1 mA |
| Isolation (field side to logic) | | 500 VAC for 1 minute (functional isolation) |
| Isolation groups | | 1 |
| Filter times | | us settings: 0.1, 0.2, 0.4, 0.8, 1.6, 3.2, 6.4, 10.0, 12.8, 20.0 ms settings: 0.05, 0.1, 0.2, 0.4, 0.8, 1.6, 3.2, 6.4, 10.0, 12.8, 20.0 |

| Technical data | CPU 1217C DC/DC/DC |
|--|--|
| HSC clock input rates (max.) (Logic 1 Level = 15 to 26 VDC) | 100/80 kHz (Ia.0 to Ia.5) 30/20 kHz (Ia.6 to Ib.1) |
| Type: Differential input | Ib.2 to Ib.5 (.2+ .2- to .5+ .5-) |
| Common mode voltage range | -7 V to +12 V, 1 second, 3 VRMS continuous (RS485 characteristics) |
| Termination and bias | 390 Ω to 2M on Ib'-, 390 Ω to +5 V on Ib'-, (biased OFF when T/B open-circuit) 220 Ω between Ib'+ and Ib'- |
| Receiver input impedance | 100 Ω including bias and termination |
| Differential receiver threshold/sensitivity | +/- 0.2 V min., 60 mV typical hysteresis |
| Isolation (field side to logic) | 500 VAC for 1 minute (functional isolation) |
| Isolation groups | 1 |
| Filter times | us settings: 0.1, 0.2, 0.4, 0.8, 1.6, 3.2, 6.4, 10.0, 12.8, 20.0 ms settings: 0.05, 0.1, 0.2, 0.4, 0.8, 1.6, 3.2, 6.4, 10.0, 12.8, 20.0 |
| HSC clock input rates (max.) | Single phase: 1 MHz (Ib.2 to Ib.5) Quadrature phase: 1 MHz (Ib.2 to Ib.5) |
| Differential input channel-to-channel skew | 40 ns max. |
| General specifications (all digital inputs) | |
| Number of inputs on simultaneously | 5 Sink/source inputs (no adjacent points) and 4 differential inputs at 60 °C horizontal or 50 °C vertical 14 at 55 °C horizontal or 45 °C vertical |
| Cable length (meters) | 500 m shielded, 300 m unshielded 50 m shielded for HSC inputs (sink/source) 50 m shielded, twisted pair for all differential inputs |

Table A- 95 Digital outputs

| Technical data | CPU 1217C DC/DC/DC |
|---|---|
| Number of outputs | 10 total 6: Solid state - MOSFET (sourcing) 4: 1.5 V differential |
| Type: Solid state - MOSFET (sourcing output) | Qa.4 to Qb.1 |
| Voltage range | 20.4 to 28.8 VDC |
| Logic 1 signal at max. current | 20 VDC min. |
| Logic 0 signal with 10 KΩ load | 0.1 VDC max. |
| Current (max.) | 0.5 A |
| Lamp load | 5 W |
| ON state resistance | 0.6 Ω max. |
| Leakage current per point | 10 μA max. |
| Surge current | 8 A for 100 ms max. |

Technical specifications

A.6 CPU 1217C

| Technical data | CPU 1217C DC/DC/DC |
|---|---|
| Overload protection | No |
| Isolation (field side to logic) | 500 VAC for 1 minute (functional isolation) |
| Isolation groups | 1 |
| Inductive clamp voltage | L+ minus 48 VDC, 1 W dissipation |
| Switching delay (Qa.0 to Qa.3) | 1.0 μ s max., off to on 3.0 μ s max., on to off |
| Switching delay (Qa.4 to Qb.1) | 50 μ s max., off to on 200 μ s max., on to off |
| Maximum relay switching frequency | -- |
| Pulse Train Output rate | 100 KHz max. (Qa.4 to Qb.1) ¹ , 2 Hz min. |
| Type: 1.5 V Differential output | Qa.0 to Qa.3 (.0+ 0- to .3+ .3-) |
| Common mode voltage range | -7 V to +12 V, 1 second, 3 VRMS continuous (RS485 characteristics) |
| Transmitter differential output voltage | 2 V min. at RL = 100 Ω , 1.5 V min. at RL = 54 Ω |
| Termination | 100 Ω between Qa+' and Qa'-' |
| Driver output impedance | 100 Ω including termination |
| Isolation | 500 VAC, 1 minute (functional isolation) |
| Isolation groups | 1 |
| Switching delay (DQa.0 to DQa.3) | 100 ns max. |
| Differential output channel-to-channel skew | 40 ns max. |
| Pulse train output rate | 1 MHz (Qa.0 to Qa.3), 2 Hz min. |
| General specifications (all digital outputs) | |
| Behavior on RUN to STOP | Last value or substitute value (default value 0) |
| Number of outputs on simultaneously | 3 Solid state - MOSFET (sourcing) outputs (no adjacent points) and 4 differential outputs at 60 °C horizontal or 50 °C vertical 10 at 55 °C horizontal or 45 °C vertical |
| Cable length (meters) | 500 m shielded, 150 m unshielded |

¹ Depending on your pulse receiver and cable, an additional load resistor (at least 10% of rated current) may improve pulse signal quality and noise immunity.

1.5 V Differential input detail

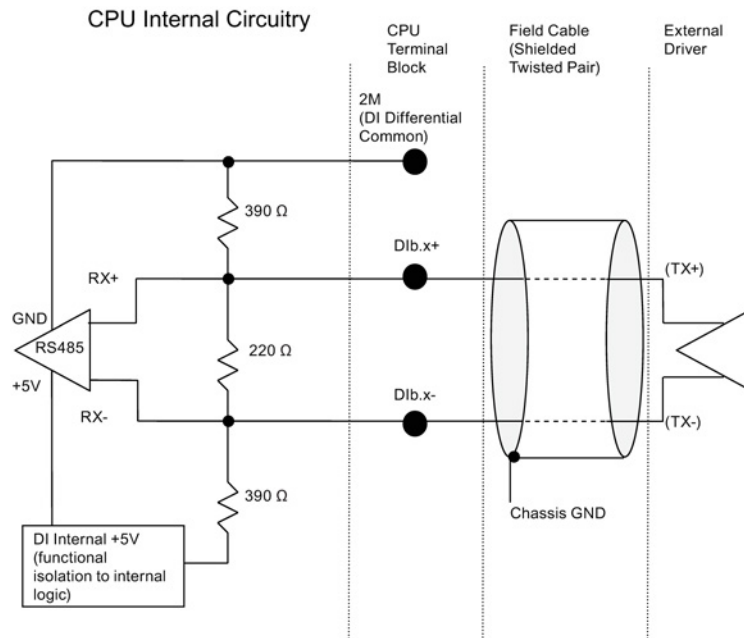

Notes:

- Each Differential DI is biased "OFF" when terminal block screws are open-circuit.
- Termination and Bias = 100 Ω.

Table A- 96 CPU 1217C Digital input (DI) H/W configuration table

| Input | Type and rate |
|-------|---|
| Dla.0 | Type: 24 V, source-sink Type 1 input High-speed counter input rate: 100 kHz max. |
| Dla.1 | Type: 24 V, source-sink Type 1 input High-speed counter input rate: 100 kHz max. |
| Dla.2 | Type: 24 V, source-sink Type 1 input High-speed counter input rate: 100 kHz max. |
| Dla.3 | Type: 24 V, source-sink Type 1 input High-speed counter input rate: 100 kHz max. |
| Dla.4 | Type: 24 V, source-sink Type 1 input High-speed counter input rate: 100 kHz max. |
| Dla.5 | Type: 24 V, source-sink Type 1 input High-speed counter input rate: 100 kHz max. |
| Dla.6 | Type: 24 V, source-sink Type 1 input High-speed counter input rate: 30 kHz max. |
| Dla.7 | Type: 24 V, source-sink Type 1 input High-speed counter input rate: 30 kHz max. |

| Input | Type and rate |
|------------|--|
| Dlb.0 | Type: 24 V, source-sink Type 1 input High-speed counter input rate: 30 kHz max. |
| Dlb.1 | Type: 24 V, source-sink Type 1 input High-speed counter input rate: 30 kHz max. |
| Dlb.2+ .2- | Type: 1.5 V Differential input High-speed counter input rate: 1 MHz max. |
| Dlb.3+ .3- | Type: 1.5 V Differential input High-speed counter input rate: 1 MHz max. |
| Dlb.4+ .4- | Type: 1.5 V Differential input High-speed counter input rate: 1 MHz max. |
| Dlb.5+ .5- | Type: 1.5 V Differential input High-speed counter input rate: 1 MHz max. |

1.5 V Differential output detail

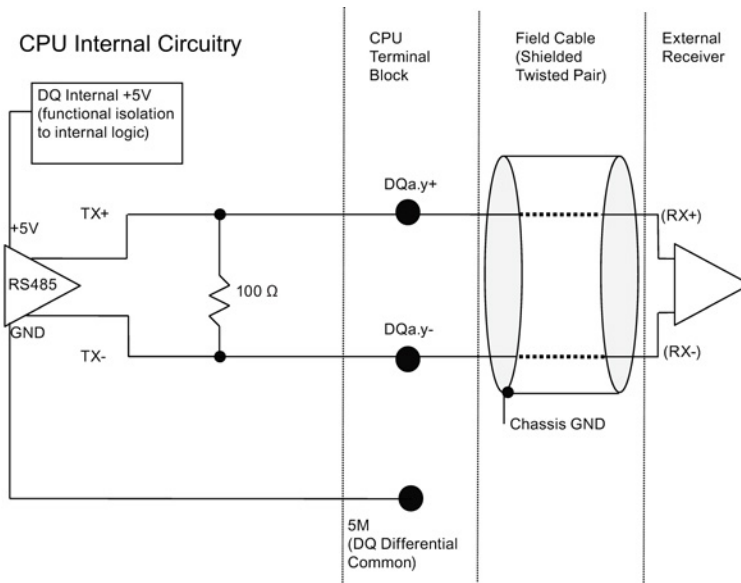

Table A- 97 CPU 1217C Digital output (DQ) H/W configuration table

| Output | Type and rate |
|------------|---|
| DQa.0+ .0- | Type: 1.5 V Differential output Pulse train output rate: 1 MHz max., 2 Hz min. |
| DQa.1+ .1- | Type: 1.5 V Differential output Pulse train output rate: 1 MHz max., 2 Hz min. |
| DQa.2+ .2- | Type: 1.5 V Differential output Pulse train output rate: 1 MHz max., 2 Hz min. |
| DQa.3+ .3- | Type: 1.5 V Differential output Pulse train output rate: 1 MHz max., 2 Hz min. |
| DQa.4 | Type: 24 V Sourcing output Pulse train output rate: 100 kHz max., 2 Hz min. |
| DQa.5 | Type: 24 V Sourcing output Pulse train output rate: 100 kHz max., 2 Hz min. |
| DQa.6 | Type: 24 V Sourcing output Pulse train output rate: 100 kHz max., 2 Hz min. |
| DQa.7 | Type: 24 V Sourcing output Pulse train output rate: 100 kHz max., 2 Hz min. |
| DQb.0 | Type: 24 V Sourcing output Pulse train output rate: 100 kHz max., 2 Hz min. |
| DQb.1 | Type: 24 V Sourcing output Pulse train output rate: 100 kHz max., 2 Hz min. |

A.6.4 Analog inputs and outputs

A.6.4.1 Analog input specifications

Table A- 98 Analog inputs

| Technical data | Description |
|------------------------------|---|
| Number of inputs | 2 |
| Type | Voltage (single-ended) |
| Full-scale range | 0 to 10 V |
| Full-scale range (data word) | 0 to 27648 |
| Overshoot range | 10.001 to 11.759 V |
| Overshoot range (data word) | 27649 to 32511 |
| Overflow range | 11.760 to 11.852 V |
| Overflow range (data word) | 32512 to 32767 |
| Resolution | 10 bits |
| Maximum withstand voltage | 35 VDC |
| Smoothing | None, Weak, Medium, or Strong See the table for step response (ms) for the analog inputs of the CPU. |
| Noise rejection | 10, 50, or 60 Hz |

A.6 CPU 1217C

| Technical data | Description |
|---------------------------------|------------------------------|
| Impedance | ≥100 KΩ |
| Isolation (field side to logic) | None |
| Accuracy (25 °C / 0 to 55 °C) | 3.0% / 3.5% of full-scale |
| Cable length (meters) | 100 m, shielded twisted pair |

A.6.4.2 Step response of built-in analog inputs of the CPU

Table A- 99 Step Response (ms), 0 V to 10 V measured at 95%

| Smoothing selection (sample averaging) | Rejection frequency (Integration time) | | |
|--|--|-------------|--------------|
| | 60 Hz | 50 Hz | 10 Hz |
| None (1 cycle): No averaging | 50 ms | 50 ms | 100 ms |
| Weak (4 cycles): 4 samples | 60ms | 70 ms | 200 ms |
| Medium (16 cycles): 16 samples | 200 ms | 240 ms | 1150 ms |
| Strong (32 cycles): 32 samples | 400 ms | 480 ms | 2300 ms |
| Sample time | 4.17 ms | 5 ms | 25 ms |

A.6.4.3 Sample time for the built-in analog ports of the CPU

Table A- 100 Sample time for built-in analog inputs of the CPU

| Rejection frequency (Integration time selection) | Sample time |
|--|-------------|
| 60 Hz (16.6 ms) | 4.17 ms |
| 50 Hz (20 ms) | 5 ms |
| 10 Hz (100 ms) | 25 ms |

A.6.4.4 Measurement ranges of the analog inputs for voltage (CPUs)

Table A- 101 Analog input representation for voltage (CPUs)

| System | | Voltage Measuring Range | |
|-----------------|-------------|-----------------------------------|-----------------|
| Decimal | Hexadecimal | 0 to 10 V | |
| 32767 | 7FFF | 11.851 V | Overflow |
| 32512 | 7F00 | | |
| 32511 | 7EFF | 11.759 V | Overshoot range |
| 27649 | 6C01 | | |
| 27648 | 6C00 | 10 V | Rated range |
| 20736 | 5100 | 7.5 V | |
| 34 | 22 | 12 mV | |
| 0 | 0 | 0 V | |
| Negative values | | Negative values are not supported | |

A.6.4.5 Analog output specifications

Analog outputs

Table A- 102 Analog outputs

| Technical data | Description |
|---------------------------------|------------------------------|
| Number of outputs | 2 |
| Type | Current |
| Full-scale range | 0 to 20 mA |
| Full-scale range (data word) | 0 to 27648 |
| Overshoot range | 20.01 to 23.52 mA |
| Overshoot range (data word) | 27649 to 32511 |
| Overflow range | see footnote ¹ |
| Overflow range data word | 32512 to 32767 |
| Resolution | 10 bits |
| Output drive impedance | ≤500 Ω max. |
| Isolation (field side to logic) | None |
| Accuracy (25 °C / -20 to 60 °C) | 3.0% / 3.5% of full-scale |
| Settling time | 2 ms |
| Cable length (meters) | 100 m, shielded twisted pair |

¹ In an overflow condition, analog outputs will behave according to the device configuration properties settings. In the "Reaction to CPU STOP" parameter, select either: "Use substitute value" or "Keep last value".

Table A- 103 Analog output representation for current (CPU 1215C and CPU 1217C)

| System | | Current output range | |
|-----------------|-------------|-----------------------------------|-----------------|
| Decimal | Hexadecimal | 0 mA to 20 mA | |
| 32767 | 7FFF | See note 1 | Overflow |
| 32512 | 7F00 | See note 1 | |
| 32511 | 7EFF | 23.52 mA | Overshoot range |
| 27649 | 6C01 | | |
| 27648 | 6C00 | 20 mA | Rated range |
| 20736 | 5100 | 15 mA | |
| 34 | 22 | 12 mV | |
| 0 | 0 | 0 mA | |
| Negative values | | Negative values are not supported | |

¹ In an overflow condition, analog outputs will behave according to the device configuration properties settings. In the "Reaction to CPU STOP" parameter, select either: "Use substitute value" or "Keep last value".

A.6.5 CPU 1217C wiring diagrams

Table A- 104 CPU 1217C DC/DC/DC (6ES7 217-1AG40-0XB0)

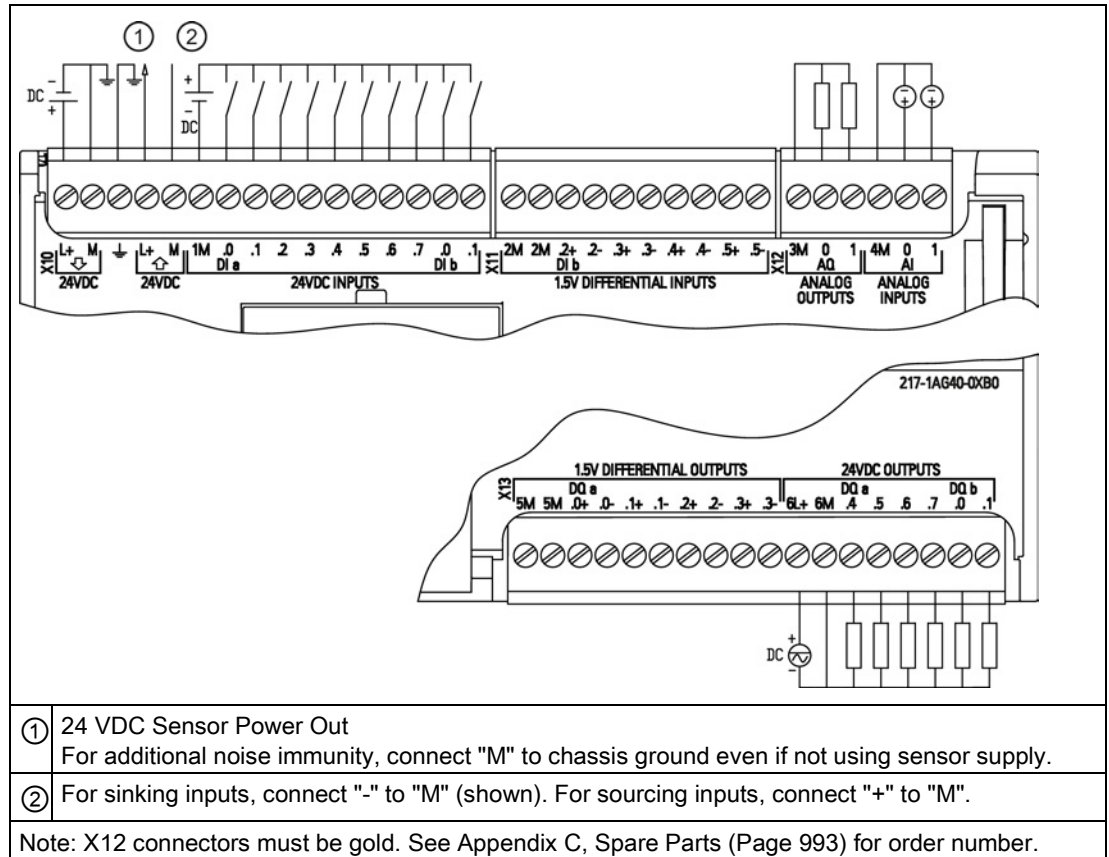

Table A- 105 Connector pin locations for CPU 1217C DC/DC/DC (6ES7 217-1AG40-0XB0)

| Pin | X10 | X11 | X12 (gold) | X13 |
|-----|------------------------|---------|------------|---------|
| 1 | L+ / 24 VDC | 2M | 3M | 5M |
| 2 | M / 24 VDC | 2M | AQ 0 | 5M |
| 3 | Functional Earth | DI b.2+ | AQ 1 | DQ a.0+ |
| 4 | L+ / 24 VDC Sensor Out | DI b.2- | 4M | DQ a.0- |
| 5 | M / 24 VDC Sensor Out | DI b.3+ | AI 0 | DQ a.1+ |
| 6 | 1M | DI b.3- | AI 1 | DQ a.1- |
| 7 | DI a.0 | DI b.4+ | -- | DQ a.2+ |
| 8 | DI a.1 | DI b.4- | -- | DQ a.2- |
| 9 | DI a.2 | DI b.5+ | -- | DQ a.3+ |
| 10 | DI a.3 | DI b.5- | -- | DQ a.3- |
| 11 | DI a.4 | -- | -- | 6L+ |
| 12 | DI a.5 | -- | -- | 6M |
| 13 | DI a.6 | -- | -- | DQ a.4 |

A.7 Digital signal modules (SMs)

| Pin | X10 | X11 | X12 (gold) | X13 |
|-----|--------|-----|------------|--------|
| 14 | DI a.7 | -- | -- | DQ a.5 |
| 15 | DI b.0 | -- | -- | DQ a.6 |
| 16 | DI b.1 | -- | -- | DQ a.7 |
| 17 | -- | -- | -- | DQ b.0 |
| 18 | -- | -- | -- | DQ b.1 |

Note

Unused analog inputs should be shorted.

A.7 Digital signal modules (SMs)

A.7.1 SM 1221 digital input specifications

Table A- 106 General specifications

| Model | SM 1221 DI 8 x 24 VDC | SM 1221 DI 16 x 24 VDC |
|------------------------------|-----------------------|------------------------|
| Order number | 6ES7 221-1BF32-0XB0 | 6ES7 221-1BH32-0XB0 |
| Dimensions W x H x D (mm) | 45 x 100 x 75 | 45 x 100 x 75 |
| Weight | 170 grams | 210 grams |
| Power dissipation | 1.5 W | 2.5 W |
| Current consumption (SM Bus) | 105 mA | 130 mA |
| Current consumption (24 VDC) | 4 mA / input used | 4 mA / input used |

Table A- 107 Digital inputs

| Model | SM 1221 DI 8 x 24 VDC | SM 1221 DI 16 x 24 VDC |
|---------------------------------|-------------------------------|-------------------------------|
| Number of inputs | 8 | 16 |
| Type | Sink/Source (IEC Type 1 sink) | Sink/Source (IEC Type 1 sink) |
| Rated voltage | 24 VDC at 4 mA, nominal | 24 VDC at 4 mA, nominal |
| Continuous permissible voltage | 30 VDC, max. | 30 VDC, max. |
| Surge voltage | 35 VDC for 0.5 sec. | 35 VDC for 0.5 sec. |
| Logic 1 signal (min.) | 15 VDC at 2.5 mA | 15 VDC at 2.5 mA |
| Logic 0 signal (max.) | 5 VDC at 1 mA | 5 VDC at 1 mA |
| Isolation (field side to logic) | 500 VAC for 1 minute | 500 VAC for 1 minute |
| Isolation groups | 2 | 4 |

| Model | SM 1221 DI 8 x 24 VDC | SM 1221 DI 16 x 24 VDC |
|------------------------------------|---|---|
| Filter times | 0.2, 0.4, 0.8, 1.6, 3.2, 6.4, and 12.8 ms (selectable in groups of 4) | 0.2, 0.4, 0.8, 1.6, 3.2, 6.4, and 12.8 ms (selectable in groups of 4) |
| Number of inputs on simultaneously | 8 | 16 |
| Cable length (meters) | 500 m shielded, 300 unshielded | 500 m shielded, 300 unshielded |

Table A- 108 Wiring diagrams for the digital input SMs

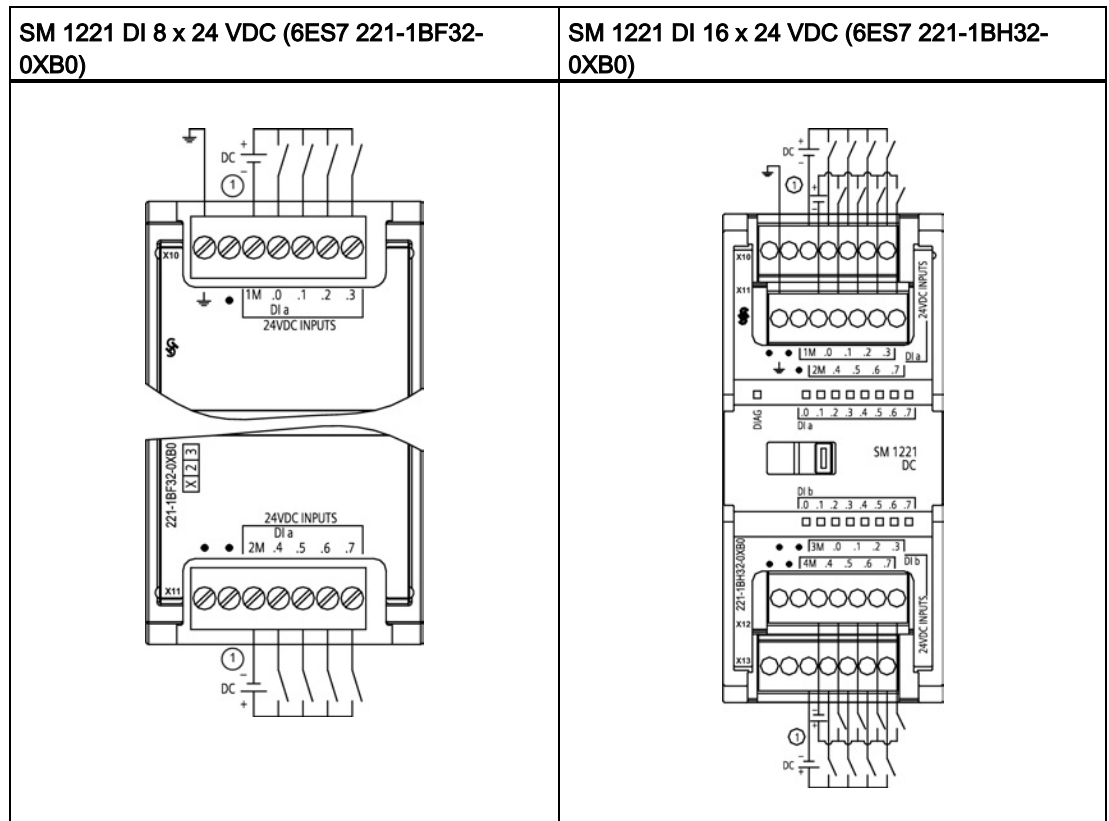

① For sinking inputs, connect "-" to "M" (shown). For sourcing inputs, connect "+" to "M".

Table A- 109 Connector pin locations for SM 1221 DI 8 x 24 VDC (6ES7 221-1BF32-0XB0)

| Pin | X10 | X11 |
|-----|---------------|---------------|
| 1 | GND | No connection |
| 2 | No connection | No connection |
| 3 | 1M | 2M |
| 4 | DI a.0 | DI a.4 |
| 5 | DI a.1 | DI a.5 |
| 6 | DI a.2 | DI a.6 |
| 7 | DI a.3 | DI a.7 |

A.7 Digital signal modules (SMs)

Table A- 110 Connector pin locations for SM 1221 DI 16 x 24 VDC (6ES7 221-1BH32-0XB0)

| Pin | X10 | X11 | X12 | X13 |
|-----|---------------|---------------|---------------|---------------|
| 1 | GND | No connection | No connection | No connection |
| 2 | No connection | No connection | No connection | No connection |
| 3 | 1M | 2M | 3 M | 4 M |
| 4 | DI a.0 | DI a.4 | DI b.0 | DI b.4 |
| 5 | DI a.1 | DI a.5 | DI b.1 | DI b.5 |
| 6 | DI a.2 | DI a.6 | DI b.2 | DI b.6 |
| 7 | DI a.3 | DI a.7 | DI b.3 | DI b.7 |

A.7.2 SM 1222 8-point digital output specifications

Table A- 111 General specifications

| Model | SM 1222 DQ 8 x Relay | SM 1222 DQ 8 RLY Changeover | SM 1222 DQ 8 x 24 VDC |
|------------------------------|-------------------------|-----------------------------|-----------------------|
| Order number | 6ES7 222-1HF32-0XB0 | 6ES7 222-1XF32-0XB0 | 6ES7 222-1BF32-0XB0 |
| Dimensions W x H x D (mm) | 45 x 100 x 75 | 70 x 100 x 75 | 45 x 100 x 75 |
| Weight | 190 grams | 310 grams | 180 grams |
| Power dissipation | 4.5 W | 5 W | 1.5 W |
| Current consumption (SM Bus) | 120 mA | 140 mA | 120 mA |
| Current consumption (24 VDC) | 11 mA / Relay coil used | 16.7 mA/Relay coil used | 50 mA |

Table A- 112 Digital outputs

| Model | SM 1222 DQ 8 x Relay | SM 1222 DQ8 RLY Changeover | SM 1222 DQ 8 x 24 VDC |
|--------------------------------|-----------------------------|-----------------------------|---------------------------------|
| Number of outputs | 8 | 8 | 8 |
| Type | Relay, dry contact | Relay change over contact | Solid state - MOSFET (sourcing) |
| Voltage range | 5 to 30 VDC or 5 to 250 VAC | 5 to 30 VDC or 5 to 250 VAC | 20.4 to 28.8 VDC |
| Logic 1 signal at max. current | -- | -- | 20 VDC min. |
| Logic 0 signal with 10K Ω load | -- | -- | 0.1 VDC max |
| Current (max.) | 2.0 A | 2.0 A | 0.5 A |
| Lamp load | 30 W DC/200 W AC | 30 W DC/200 W AC | 5 W |
| ON state contact resistance | 0.2 Ω max. when new | 0.2 Ω max. when new | 0.6 Ω max. |
| Leakage current per point | -- | -- | 10 μA max. |
| Surge current | 7 A with contacts closed | 7 A with contacts closed | 8 A for 100 ms max. |
| Overload protection | No | No | No |

| Model | SM 1222 DQ 8 x Relay | SM 1222 DQ8 RLY Changeover | SM 1222 DQ 8 x 24 VDC |
|--|---|---|--|
| Isolation (field side to logic) | 1500 VAC for 1 minute (coil to contact) None (coil to logic) | 1500 VAC for 1 minute (coil to contact) | 500 VAC for 1 minute |
| Isolation resistance | 100 MΩ min. when new | 100 MΩ min. when new | -- |
| Isolation between open contacts | 750 VAC for 1 minute | 750 VAC for 1 minute | -- |
| Isolation groups | 2 | 8 | 1 |
| Current per common (max.) | 10 A | 2 A | 4 A |
| Inductive clamp voltage | -- | -- | L+ minus 48 V, 1 W dissipation |
| Switching delay | 10 ms max. | 10 ms max | 50 μs max. off to on 200 μs max. on to off |
| Maximum relay switching frequency | 1 Hz | 1 Hz | -- |
| Lifetime mechanical (no load) | 10,000,000 open/close cycles | 10,000,000 open/close cycles | -- |
| Lifetime contacts at rated load (N.O. contact) | 100,000 open/close cycles | 100,000 open/close cycles | -- |
| Behavior on RUN to STOP | Last value or substitute value (default value 0) | Last value or substitute value (default value 0) | Last value or substitute value (default value 0) |
| Number of outputs on simultaneously | 8 | <ul style="list-style-type: none"> • 4 (no adjacent points) at 60 °C horizontal or 50 °C vertical • 8 at 55 °C horizontal or 45 °C vertical | 8 |
| Cable length (meters) | 500 m shielded, 150 m unshielded | 500 m shielded, 150 m unshielded | 500 m shielded, 150 m unshielded |

A.7.3 SM 1222 16-point digital output specifications

Table A- 113 General specifications

| Model | SM 1222 DQ 16 x Relay | SM 1222 DQ 16 x 24 VDC |
|------------------------------|-------------------------|------------------------|
| Order number | 6ES7 222-1HH32-0XB0 | 6ES7 222-1BH32-0XB0 |
| Dimensions W x H x D (mm) | 45 x 100 x 75 | 45 x 100 x 75 |
| Weight | 260 grams | 220 grams |
| Power dissipation | 8.5 W | 2.5 W |
| Current consumption (SM Bus) | 135 mA | 140 mA |
| Current consumption (24 VDC) | 11 mA / Relay coil used | 100 mA |

Technical specifications

A.7 Digital signal modules (SMs)

Table A- 114 Digital outputs

| Model | SM1222 DQ 16 x Relay | SM1222 DQ 16 x 24 VDC |
|--|--|---|
| Number of outputs | 16 | 16 |
| Type | Relay, dry contact | Solid state - MOSFET (sourcing) |
| Voltage range | 5 to 30 VDC or 5 to 250 VAC | 20.4 to 28.8 VDC |
| Logic 1 signal at max. current | - | 20 VDC min. |
| Logic 0 signal with 10K Ω load | - | 0.1 VDC max. |
| Current (max.) | 2.0 A | 0.5 A |
| Lamp load | 30 W DC/200 W AC | 5 W |
| ON state contact resistance | 0.2 Ω max. when new | 0.6 Ω max. |
| Leakage current per point | -- | 10 μ A max. |
| Surge current | 7 A with contacts closed | 8 A for 100 ms max. |
| Overload protection | No | No |
| Isolation (field side to logic) | 1500 VAC for 1 minute (coil to contact) None (coil to logic) | 500 VAC for 1 minute |
| Isolation resistance | 100 M Ω min. when new | - |
| Isolation between open contacts | 750 VAC for 1 minute | - |
| Isolation groups | 4 | 1 |
| Current per common (max.) | 10 A | 8 A |
| Inductive clamp voltage | - | L+ minus 48 V, 1 W dissipation |
| Switching delay | 10 ms max. | 50 μ s max. off to on 200 μ s max. on to off |
| Maximum relay switching frequency | 1 Hz | - |
| Lifetime mechanical (no load) | 10,000,000 open/close cycles | - |
| Lifetime contacts at rated load (N.O. contact) | 100,000 open/close cycles | - |
| Behavior on RUN to STOP | Last value or substitute value (default value 0) | Last value or substitute value (default value 0) |
| Number of outputs on simultaneously | <ul style="list-style-type: none"> • 8 (no adjacent points) at 60 °C horizontal or 50 °C vertical • 16 at 55 °C horizontal or 45 °C vertical | 16 |
| Cable length (meters) | 500 m shielded, 150 m unshielded | 500 m shielded, 150 m unshielded |

Table A- 115 Wiring diagrams for the 8-point digital output SMs

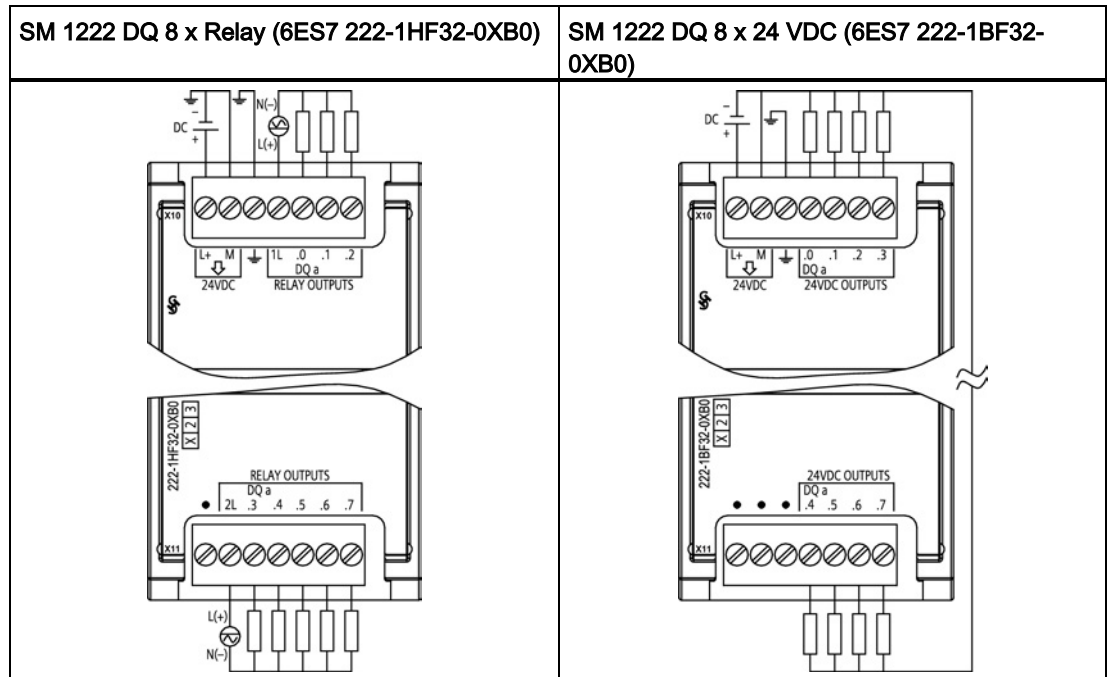

Table A- 116 Connector pin locations for SM 1222 DQ 8 x Relay (6ES7 222-1HF32-0XB0)

| Pin | X10 | X11 |
|-----|------------------|---------------|
| 1 | L+ / 24 VDC | No connection |
| 2 | M / 24 VDC | 2L |
| 3 | Functional Earth | DQ a.3 |
| 4 | 1L | DQ a.4 |
| 5 | DQ a.0 | DQ a.5 |
| 6 | DQ a.1 | DQ a.6 |
| 7 | DQ a.2 | DQ a.7 |

Table A- 117 Connector pin locations for SM 1222 DQ 8 x 24 VDC (6ES7 222-1BF32-0XB0)

| Pin | X10 | X11 |
|-----|------------------|---------------|
| 1 | L+ / 24 VDC | No connection |
| 2 | M / 24 VDC | No connection |
| 3 | Functional Earth | No connection |
| 4 | DQ a.0 | DQ a.4 |
| 5 | DQ a.1 | DQ a.5 |
| 6 | DQ a.2 | DQ a.6 |
| 7 | DQ a.2 | DQ a.7 |

Table A- 118 Wiring diagram for the 8-point digital output relay changeover SM

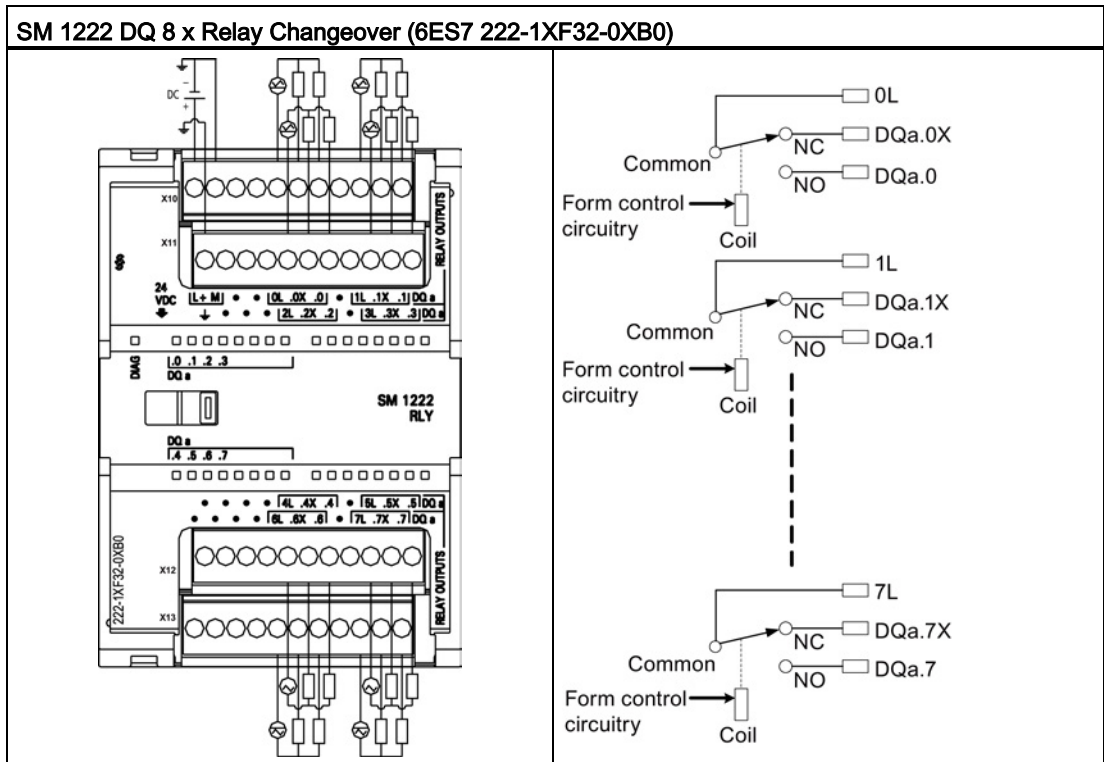

A changeover relay output controls two circuits using a common terminal: one normally closed contact, and one normally open contact. Using output "0" as an example, when the output point is OFF, the common (0L) is connected to the normally closed contact (.0X) and disconnected from the normally open contact (.0). When the output point is ON, the common (0L) is disconnected from the normally closed contact (.0X) and connected to the normally open contact (.0).

Table A- 119 Connector pin locations for SM 1222 DQ 8 x Relay Changeover (6ES7 222-1XF32-0XB0)

| Pin | X10 | X11 | X12 | X13 |
|-----|---------------|------------------|---------------|---------------|
| 1 | L+ / 24 VDC | Functional Earth | No connection | No connection |
| 2 | M / 24 VDC | No connection | No connection | No connection |
| 3 | No connection | No connection | No connection | No connection |
| 4 | No connection | No connection | No connection | No connection |
| 5 | 0L | 2L | 4L | 6L |
| 6 | DQ a.0X | DQ a.2X | DQ a.4X | DQ a.6X |
| 7 | DQ a.0 | DQ a.2 | DQ a.4 | DQ a.6 |
| 8 | No connection | No connection | No connection | No connection |
| 9 | 1L | 3L | 5L | 7L |
| 10 | DQ a.1X | DQ a.3X | DQ a.5X | DQ a.7X |
| 11 | DQ a.1 | DQ a.3 | DQ a.5 | DQ a.7 |

Table A- 120 Wiring diagrams for the 16-point digital output SMs

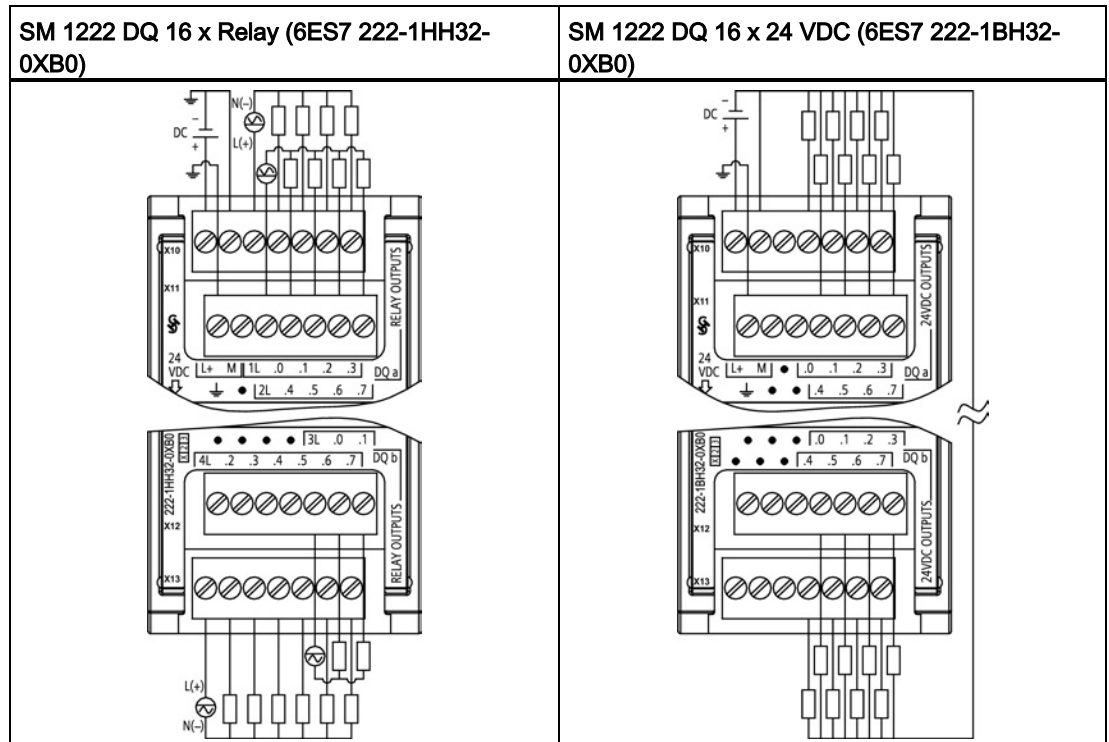

Table A- 121 Connector pin locations for SM 1222 DQ 16 x Relay (6ES7 222-1HH32-0XB0)

| Pin | X10 | X11 | X12 | X13 |
|-----|-------------|------------------|---------------|--------|
| 1 | L+ / 24 VDC | Functional Earth | No connection | 4L |
| 2 | M / 24 VDC | No connection | No connection | DQ b.2 |
| 3 | 1L | 2L | No connection | DQ b.3 |
| 4 | DQ a.0 | DQ a.4 | No connection | DQ b.4 |
| 5 | DQ a.1 | DQ a.5 | 3L | DQ b.5 |
| 6 | DQ a.2 | DQ a.6 | DQ b.0 | DQ b.6 |
| 7 | DQ a.3 | DQ a.7 | DQ b.1 | DQ b.7 |

Table A- 122 Connector pin locations for SM 1222 DQ 16 x 24 VDC (6ES7 222-1BH32-0XB0)

| Pin | X10 | X11 | X12 | X13 |
|-----|---------------|------------------|---------------|---------------|
| 1 | L+ / 24 VDC | Functional Earth | No connection | No connection |
| 2 | M / 24 VDC | No connection | No connection | No connection |
| 3 | No connection | No connection | No connection | No connection |
| 4 | DQ a.0 | DQ a.4 | DQ b.0 | DQ b.4 |
| 5 | DQ a.1 | DQ a.5 | DQ b.1 | DQ b.5 |
| 6 | DQ a.2 | DQ a.6 | DQ b.2 | DQ b.6 |
| 7 | DQ a.3 | DQ a.7 | DQ b.3 | DQ b.7 |

A.7.4 SM 1223 digital input/output VDC specifications

Table A- 123 General specifications

| Model | SM 1223 DI 8 x 24 VDC, DQ 8 x Relay | SM 1223 DI 16 x 24 VDC, DQ 16 x Relay | SM 1223 DI 8 x 24 VDC, DQ 8 x 24 VDC | SM 1223 DI 16 x 24 VDC, DQ 16 x 24 VDC |
|------------------------------|--|---|--|--|
| Order number | 6ES7 223-1PH32-0XB0 | 6ES7 223-1PL32-0XB0 | 6ES7 223-1BH32-0XB0 | 6ES7 223-1BL32-0XB0 |
| Dimensions W x H x D (mm) | 45 x 100 x 75 | 70 x 100 x 75 | 45 x 100 x 75 | 70 x 100 x 75 |
| Weight | 230 grams | 350 grams | 210 grams | 310 grams |
| Power dissipation | 5.5 W | 10 W | 2.5 W | 4.5 W |
| Current consumption (SM Bus) | 145 mA | 180 mA | 145 mA | 185 mA |
| Current consumption (24 VDC) | 4 mA / Input used 11 mA / Relay coil used | | 150 mA | 200 mA |

Table A- 124 Digital inputs

| Model | SM 1223 DI 8 x 24 VDC, DQ 8 x Relay | SM 1223 DI 16 x 24 VDC, DQ 16 x Relay | SM 1223 DI 8 x 24 VDC, DQ 8 x 24 VDC | SM 1223 DI 16 x 24 VDC, DQ 16 x 24 VDC |
|------------------------------------|--|--|--|--|
| Number of inputs | 8 | 16 | 8 | 16 |
| Type | Sink/Source (IEC Type 1 sink) | | | |
| Rated voltage | 24 VDC at 4 mA, nominal | | | |
| Continuous permissible voltage | 30 VDC max. | | | |
| Surge voltage | 35 VDC for 0.5 sec. | | | |
| Logic 1 signal (min.) | 15 VDC at 2.5 mA | | | |
| Logic 0 signal (max.) | 5 VDC at 1 mA | | | |
| Isolation (field side to logic) | 500 VAC for 1 minute | | | |
| Isolation groups | 2 | 2 | 2 | 2 |
| Filter times | 0.2, 0.4, 0.8, 1.6, 3.2, 6.4, and 12.8 ms, selectable in groups of 4 | | | |
| Number of inputs on simultaneously | 8 | <ul style="list-style-type: none"> • 8 (no adjacent points) at 60 °C horizontal or 50 °C vertical • 16 at 55 °C horizontal or 45 °C vertical | 8 | 16 |
| Cable length (meters) | 500 m shielded, 300 m unshielded | | | |

Table A- 125 Digital outputs

| Model | SM 1223 DI 8 x 24 VDC, DQ 8 x Relay | SM 1223 DI 16 x 24 VDC, DQ 16 x Relay | SM 1223 DI 8 x 24 VDC, DQ 8 x 24 VDC | SM 1223 DI 16 x 24 VDC, DQ 16 x 24 VDC |
|--|---|--|---|--|
| Number of outputs | 8 | 16 | 8 | 16 |
| Type | Relay, dry contact | | Solid state - MOSFET (sourcing) | |
| Voltage range | 5 to 30 VDC or 5 to 250 VAC | | 20.4 to 28.8 VDC | |
| Logic 1 signal at max. current | -- | | 20 VDC, min. | |
| Logic 0 signal with 10 K Ω load | -- | | 0.1 VDC, max. | |
| Current (max.) | 2.0 A | | 0.5 A | |
| Lamp load | 30 W DC / 200 W AC | | 5 W | |
| ON state contact resistance | 0.2 Ω max. when new | | 0.6 Ω max. | |
| Leakage current per point | -- | | 10 μ A max. | |
| Surge current | 7 A with contacts closed | | 8 A for 100 ms max. | |
| Overload protection | No | | | |
| Isolation (field side to logic) | 1500 VAC for 1 minute (coil to contact) None (coil to logic) | | 500 VAC for 1 minute | |
| Isolation resistance | 100 M Ω min. when new | | -- | |
| Isolation between open contacts | 750 VAC for 1 minute | | -- | |
| Isolation groups | 2 | 4 | 1 | 1 |
| Current per common | 10A | 8 A | 4 A | 8 A |
| Inductive clamp voltage | -- | | L+ minus 48 V, 1 W dissipation | |
| Switching delay | 10 ms max. | | 50 μ s max. off to on 200 μ s max. on to off | |
| Maximum relay switching frequency | 1 Hz | | -- | |
| Lifetime mechanical (no load) | 10,000,000 open/close cycles | | -- | |
| Lifetime contacts at rated load (N.O. contact) | 100,000 open/close cycles | | -- | |
| Behavior on RUN to STOP | Last value or substitute value (default value 0) | | | |
| Number of outputs on simultaneously | 8 | <ul style="list-style-type: none"> • 8 (no adjacent points) at 60 °C horizontal or 50 °C vertical • 16 at 55 °C horizontal or 45 °C vertical | 8 | 16 |
| Cable length (meters) | 500 m shielded, 150 m unshielded | | | |

A.7 Digital signal modules (SMs)

Table A- 126 Wiring diagrams for the digital input VDC/output relay SMs

| SM 1223 DI 8 x 24 VDC, DQ 8 x Relay (6ES7 223-1PH32-0XB0) | SM 1223 DI 16 x 24 VDC, DQ 16 x Relay (6ES7 223-1PL32-0XB0) | Notes |
|--|---|---|
|  |  | <p>① For sinking inputs, connect "-" to "M" (shown). For sourcing inputs, connect "+" to "M".</p> |

Table A- 127 Connector Pin Locations for SM 1223 DI 8 x 24 VDC, DQ 8 x Relay (6ES7 223-1PH32-0XB0)

| Pin | X10 | X11 | X12 | X13 |
|-----|-------------|---------------|---------------|---------------|
| 1 | L+ / 24 VDC | GND | No connection | No connection |
| 2 | M / 24 VDC | No connection | No connection | No connection |
| 3 | 1M | 2M | 1L | 2L |
| 4 | DI a.0 | DI a.4 | DQ a.0 | DQ a.4 |
| 5 | DI a.1 | DI a.5 | DQ a.1 | DQ a.5 |
| 6 | DI a.2 | DI a.6 | DQ a.2 | DQ a.6 |
| 7 | DI a.3 | DI a.7 | DQ a.3 | DQ a.7 |

Table A- 128 Connector Pin Locations for SM 1223 DI 16 x 24 VDC, DQ 16 x Relay (6ES7 223-1PL32-0XB0)

| Pin | X10 | X11 | X12 | X13 |
|-----|-------------|---------------|---------------|---------------|
| 1 | L+ / 24 VDC | GND | 1L | 3L |
| 2 | M / 24 VDC | No connection | DQ a.0 | DQ b.0 |
| 3 | 1M | 2M | DQ a.1 | DQ b.1 |
| 4 | DI a.0 | DI b.0 | DQ a.2 | DQ b.2 |
| 5 | DI a.1 | DI b.1 | DQ a.3 | DQ b.3 |
| 6 | DI a.2 | DI b.2 | No connection | No connection |
| 7 | DI a.3 | DI b.3 | 2L | 4L |
| 8 | DI a.4 | DI b.4 | DQ a.4 | DQ b.4 |
| 9 | DI a.5 | DI b.5 | DQ a.5 | DQ b.5 |
| 10 | DI a.6 | DI b.6 | DQ a.6 | DQ b.6 |
| 11 | DI a.7 | DI b.7 | DQ a.7 | DQ b.7 |

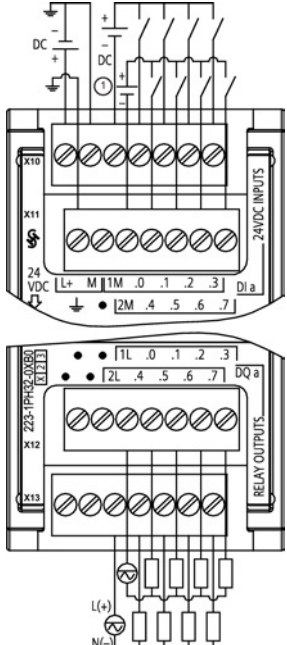
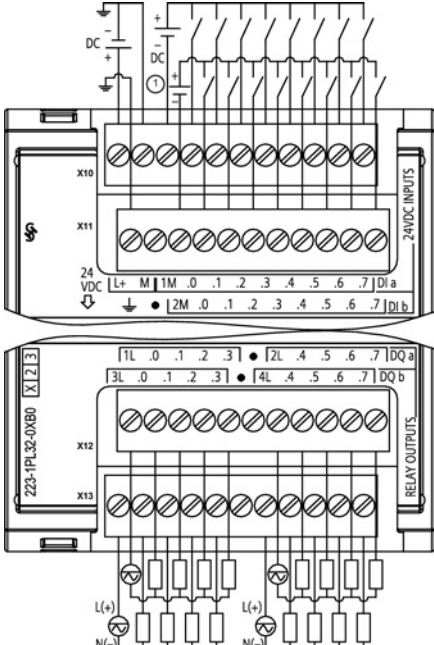
Table A- 129 Wiring diagrams for the digital input VDC/output SMs

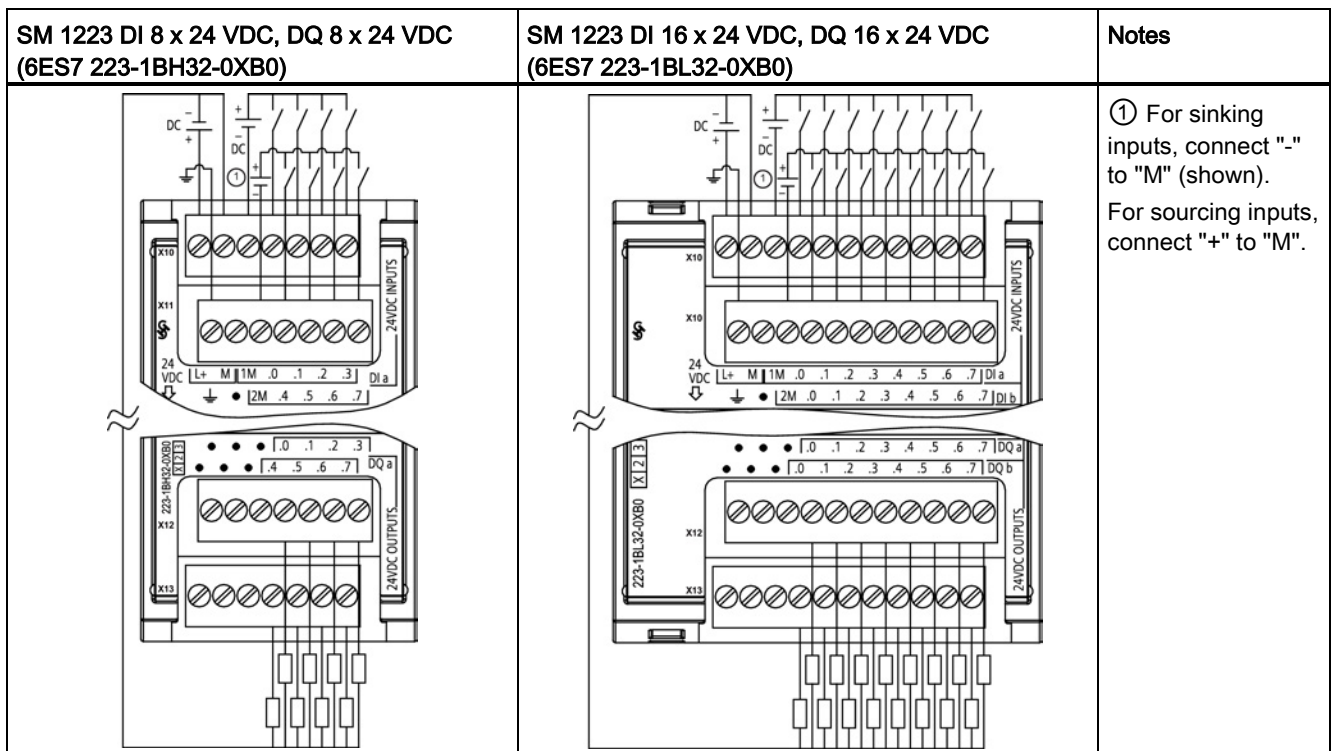

A.7 Digital signal modules (SMs)

Table A- 130 Connector Pin Locations for SM 1223 DI 8 x 24 VDC, DQ 8 x 24 VDC (6ES7 223-1BH32-0XB0)

| Pin | X10 | X11 | X12 | X13 |
|-----|-------------|---------------|---------------|---------------|
| 1 | L+ / 24 VDC | GND | No connection | No connection |
| 2 | M / 24 VDC | No connection | No connection | No connection |
| 3 | 1M | 2M | No connection | No connection |
| 4 | DI a.0 | DI a.4 | DQ a.0 | DQ a.4 |
| 5 | DI a.1 | DI a.5 | DQ a.1 | DQ a.5 |
| 6 | DI a.2 | DI a.6 | DQ a.2 | DQ a.6 |
| 7 | DI a.3 | DI a.7 | DQ a.3 | DQ a.7 |

Table A- 131 Connector Pin Locations for SM 1223 DI 16 x 24 VDC, DQ 16 x 24 VDC (6ES7 223-1BL32-0XB0)

| Pin | X10 | X11 | X12 | X13 |
|-----|-------------|---------------|---------------|---------------|
| 1 | L+ / 24 VDC | GND | No connection | No connection |
| 2 | M / 24 VDC | No connection | No connection | No connection |
| 3 | 1M | 2M | No connection | No connection |
| 4 | DI a.0 | DI b.0 | DQ a.0 | DQ b.0 |
| 5 | DI a.1 | DI b.1 | DQ a.1 | DQ b.1 |
| 6 | DI a.2 | DI b.2 | DQ a.2 | DQ b.2 |
| 7 | DI a.3 | DI b.3 | DQ a.3 | DQ b.3 |
| 8 | DI a.4 | DI b.4 | DQ a.4 | DQ b.4 |
| 9 | DI a.5 | DI b.5 | DQ a.5 | DQ b.5 |
| 10 | DI a.6 | DI b.6 | DQ a.6 | DQ b.6 |
| 11 | DI a.7 | DI b.7 | DQ a.7 | DQ b.7 |

A.7.5 SM 1223 digital input/output AC specifications

Table A- 132 General specifications

| | |
|------------------------------|---|
| Model | SM 1223 DI 8 x120/230 VAC / DQ 8 x Relay |
| Order number | 6ES7 223-1QH32-0XB0 |
| Dimensions W x H x D (mm) | 45 x 100 x 75 mm |
| Weight | 190 grams |
| Power dissipation | 7.5 W |
| Current consumption (SM Bus) | 120 mA |
| Current consumption (24 VDC) | 11 mA per output when on |

Table A- 133 Digital inputs

| Model | SM 1223 DI 8 x 120/230 VAC / DQ 8 x Relay |
|---|--|
| Number of inputs | 8 |
| Type | IEC Type 1 |
| Rated voltage | 120 VAC at 6 mA, 230 VAC at 9 mA |
| Continuous permissible voltage | 264 VAC |
| Surge voltage | -- |
| Logic 1 signal (min.) | 79 VAC at 2.5 mA |
| Logic 0 signal (max.) | 20 VAC at 1 mA |
| Leakage current (max.) | 1 mA |
| Isolation (field side to logic) | 1500 VAC for 1 minute |
| Isolation groups ¹ | 4 |
| Input delay times | Typical: 0.2 to 12.8 ms, user selectable Maximum: - |
| Connection of 2 wire proximity sensor (Bero) (max.) | 1 mA |
| Cable length | Unshielded: 300 meters Shielded: 500 meters |
| Number of inputs on simultaneously | 8 |

¹ Channels within a group must be of the same phase.

Table A- 134 Digital outputs

| Model | SM 1223 DI 8 x 120/230 VAC / DQ 8 x Relay |
|---------------------------------------|---|
| Number of outputs | 8 |
| Type | Relay, dry contact |
| Voltage range | 5 to 30 VDC or 5 to 250 VAC |
| Logic 1 signal at max. current | -- |
| Logic 0 signal with 10K Ω load | -- |
| Current (max.) | 2.0 A |
| Lamp load | 30 W DC / 200 W AC |
| ON state contact resistance | 0.2 Ω max. when new |
| Leakage current per point | -- |
| Surge current | 7 A with contacts closed |
| Overload protection | No |
| Isolation (field side to logic) | 1500 VAC for 1 minute (coil to contact) None (coil to logic) |
| Isolation resistance | 100 M Ω min. when new |
| Isolation between open contacts | 750 VAC for 1 minute |
| Isolation groups | 2 |
| Current per common (max.) | 10 A |
| Inductive clamp voltage | -- |

Technical specifications

A.7 Digital signal modules (SMs)

| | | |
|-------------------------------------|---|--|
| Model | SM 1223 DI 8 x 120/230 VAC / DQ 8 x Relay | |
| Switching delay (max.) | 10 ms | |
| Maximum relay switching frequency | 1 Hz | |
| Lifetime mechanical (no load) | 10,000,000 open/close cycles | |
| Lifetime contacts at rated load | 1000,000 open/close cycles | |
| Behavior on RUN to STOP | Last value or substitute value (default value 0) | |
| Number of outputs on simultaneously | <ul style="list-style-type: none"> • 4 (no adjacent points) at 60 °C horizontal or 50 °C vertical • 8 at 55 °C horizontal or 45 °C vertical | |
| Cable length (meters) | 500 m shielded, 150 m unshielded | |

Table A- 135 SM 1223 DI 8 x 120/230 VAC, DQ 8 x Relay (6ES7 223-1QH32-0XB0)

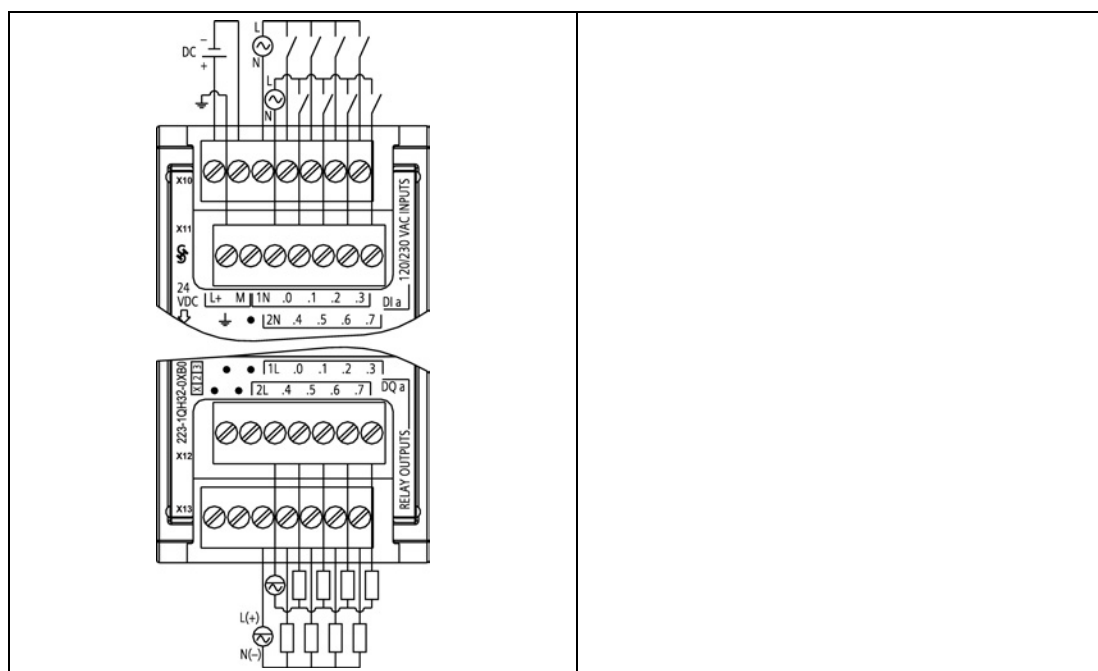

Table A- 136 Connector Pin Locations for SM 1223 DI 8 x 120/240 VAC, DQ 8 x Relay (6ES7 223-1QH32-0XB0)

| Pin | X10 | X11 | X12 | X13 |
|-----|-------------|---------------|---------------|---------------|
| 1 | L+ / 24 VDC | GND | No connection | No connection |
| 2 | M / 24 VDC | No connection | No connection | No connection |
| 3 | 1N | 2N | 1L | 2L |
| 4 | DI a.0 | DI a.4 | DQ a.0 | DQ a.4 |
| 5 | DI a.1 | DI a.5 | DQ a.1 | DQ a.5 |
| 6 | DI a.2 | DI a.6 | DQ a.2 | DQ a.6 |
| 7 | DI a.3 | DI a.7 | DQ a.3 | DQ a.7 |

A.8 Analog signal modules (SMs)

A.8.1 SM 1231 analog input module specifications

Table A- 137 General specifications

| Model | SM 1231 AI 4 x 13 bit | SM 1231 AI 8 x 13 bit | SM 1231 AI 4 x 16 bit |
|------------------------------|-----------------------|-----------------------|-----------------------|
| Order number | 6ES7 231-4HD32-0XB0 | 6ES7 231-4HF32-0XB0 | 6ES7 231-5ND30-0XB0 |
| Dimensions W x H x D (mm) | 45 x 100 x 75 | 45 x 100 x 75 | 45 x 100 x 75 |
| Weight | 180 grams | 180 grams | 180 grams |
| Power dissipation | 2.2 W | 2.3 W | 2.0 W |
| Current consumption (SM Bus) | 80 mA | 90 mA | 80 mA |
| Current consumption (24 VDC) | 45 mA | 45 mA | 65 mA |

Table A- 138 Analog inputs

| Model | SM 1231 AI 4 x 13 bit | SM 1231 AI 8 x 13 bit | SM 1231 AI 4 x 16 bit |
|---|--|-----------------------|---|
| Number of inputs | 4 | 8 | 4 |
| Type | Voltage or current (differential): Selectable in groups of 2 | | Voltage or current (differential) |
| Range | ±10 V, ±5 V, ±2.5 V, 0 to 20 mA, or 4 mA to 20 mA | | ±10 V, ±5 V, ±2.5 V, ±1.25 V, 0 to 20 mA or 4 mA to 20 mA |
| Full scale range (data word) | -27648 to 27648 voltage / 0 to 27648 current | | |
| Overshoot/undershoot range (data word) | Voltage: 32511 to 27649 / -27649 to -32,512 Current: 32511 to 27649 / 0 to -4864 | | |
| Refer to the section on analog input ranges for voltage and current (Page 916). | | | |
| Overflow/underflow (data word) | Voltage: 32767 to 32512 / -32513 to -32768 Current 0 to 20 mA: 32767 to 32512 / -4865 to -32768 Current 4 to 20 mA: 32767 to 32512 (values below -4864 indicate open wire) | | |
| Refer to the section on input ranges for voltage and current (Page 916). | | | |
| Resolution1 | 12 bits + sign bit | | 15 bits + sign bit |
| Maximum withstand voltage/current | ±35 V / ±40 mA | | |
| Smoothing | None, weak, medium, or strong Refer to the section on step response times (Page 916). | | |
| Noise rejection | 400, 60, 50, or 10 Hz Refer to the section on sample rates (Page 916). | | |
| Input impedance | ≥ 9 MΩ (voltage) / 280 Ω (current) | | ≥ 1 MΩ (voltage) / <315 Ω, >280 Ω (current) |

Technical specifications

A.8 Analog signal modules (SMs)

| Model | SM 1231 AI 4 x 13 bit | SM 1231 AI 8 x 13 bit | SM 1231 AI 4 x 16 bit |
|---------------------------------------|--|-----------------------|-----------------------------|
| Isolation | None | | |
| Field side to logic | | | 500 VAC |
| Logic to 24 VDC | | | 500 VAC |
| Field side to 24 VDC | | | 500 VAC |
| Channel to channel | None | | |
| Accuracy (25 °C / -20 to 60 °C) | ±0.1% / ±0.2% of full scale | | ±0.1% / ±0.3% of full scale |
| Measuring principle | Actual value conversion | | |
| Common mode rejection | 40 dB, DC to 60 Hz | | |
| Operational signal range ¹ | Signal plus common mode voltage must be less than +12 V and greater than -12 V | | |
| Cable length (meters) | 100 m, twisted and shielded | | |

¹ Voltages outside the operational range applied to one channel may cause interference on other channels.

Table A- 139 Diagnostics

| Model | SM 1231 AI 4 x 13 bit | SM 1231 AI 8 x 13 bit | SM 1231 AI 4 x 16 bit |
|--------------------|---|-----------------------|-----------------------|
| Overflow/underflow | Yes | Yes | Yes |
| 24 VDC low voltage | Yes | Yes | Yes |
| Open wire | 4 to 20 mA range only (if input is below -4164; 1.185 mA) | | |

Table A- 140 Wiring diagrams for the analog input SMs

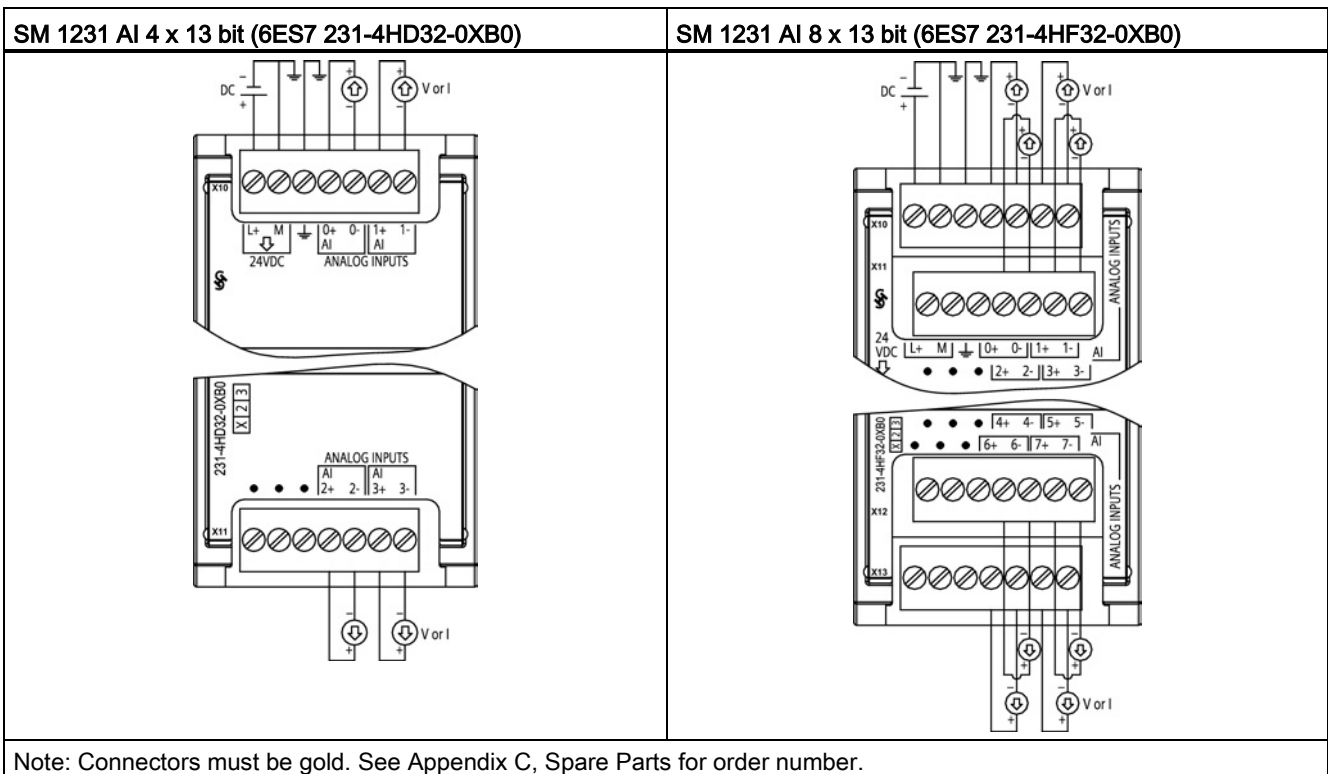

Table A- 141 Connector pin locations for SM 1231 AI 4 x 13 bit (6ES7 231-4HD32-0XB0)

| Pin | X10 (gold) | X11 (gold) |
|-----|-------------|---------------|
| 1 | L+ / 24 VDC | No connection |
| 2 | M / 24 VDC | No connection |
| 3 | GND | No connection |
| 4 | AI 0+ | AI 2+ |
| 5 | AI 0- | AI 2- |
| 6 | AI 1+ | AI 3+ |
| 7 | AI 1- | AI 3- |

Table A- 142 Connector pin locations for SM 1231 AI 8 x 13 bit (6ES7 231-4HF32-0XB0)

| Pin | X10 (gold) | X11 (gold) | X12 (gold) | X13 (gold) |
|-----|-------------|---------------|---------------|---------------|
| 1 | L+ / 24 VDC | No connection | No connection | No connection |
| 2 | M / 24 VDC | No connection | No connection | No connection |
| 3 | GND | No connection | No connection | No connection |
| 4 | AI 0+ | AI 2+ | AI 4+ | AI 6+ |
| 5 | AI 0- | AI 2- | AI 4- | AI 6- |
| 6 | AI 1+ | AI 3+ | AI 5+ | AI 7+ |
| 7 | AI 1- | AI 3- | AI 5- | AI 7- |

Table A- 143 Wiring diagram for the analog input SM

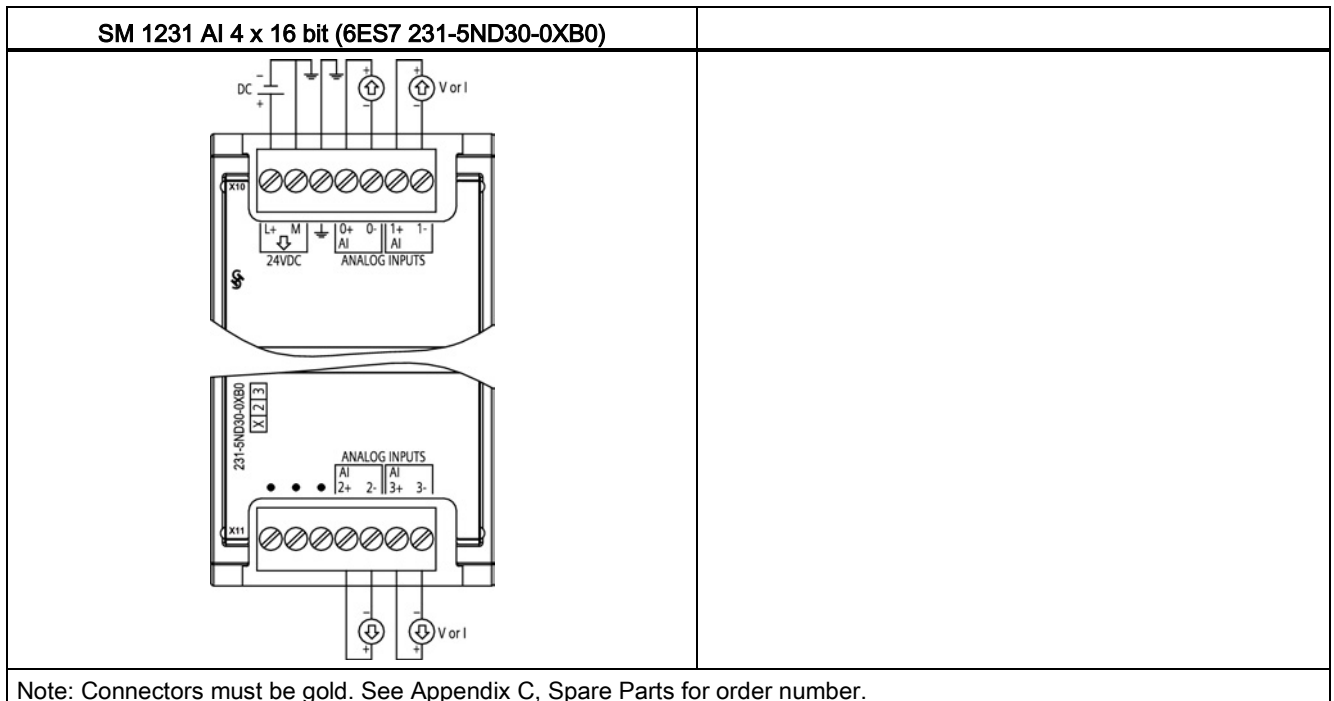

Table A- 144 Connector pin locations for SM 1231 AI 4 x 16 bit (6ES7 231-5ND30-0XB0)

| Pin | X10 (gold) | X11 (gold) |
|-----|-------------|---------------|
| 1 | L+ / 24 VDC | No connection |
| 2 | M / 24 VDC | No connection |
| 3 | GND | No connection |
| 4 | AI 0+ | AI 2+ |
| 5 | AI 0- | AI 2- |
| 6 | AI 1+ | AI 3+ |
| 7 | AI 1- | AI 3- |

Note

Unused voltage input channels should be shorted.

Unused current input channels should be set to the 0 to 20 mA range and/or disable broken wire error reporting.

Inputs configured for current mode will not conduct loop current unless the module is powered and configured.

Current input channels will not operate unless external power is supplied to the transmitter.

A.8.2 SM 1232 analog output module specifications

Table A- 145 General specifications

| Technical data | SM 1232 AQ 2 x 14 bit | SM 1232 AQ 4 x 14 bit |
|------------------------------|-----------------------|-----------------------|
| Order number | 6ES7 232-4HB32-0XB0 | 6ES7 232-4HD32-0XB0 |
| Dimensions W x H x D (mm) | 45 x 100 x 75 | 45 x 100 x 75 |
| Weight | 180 grams | 180 grams |
| Power dissipation | 1.8 W | 2.0 W |
| Current consumption (SM Bus) | 80 mA | 80 mA |
| Current consumption (24 VDC) | 45 mA (no load) | 45 mA (no load) |

Table A- 146 Analog outputs

| Technical data | SM 1232 AQ 2 x 14 bit | SM 1232 AQ 4 x 14 bit |
|-------------------|--------------------------------------|--------------------------------------|
| Number of outputs | 2 | 4 |
| Type | Voltage or current | Voltage or current |
| Range | ±10 V, 0 to 20 mA, or 4 mA to 20 mA | ±10 V, 0 to 20 mA, or 4 mA to 20 mA |
| Resolution | Voltage: 14 bits Current: 13 bits | Voltage: 14 bits Current: 13 bits |

| Technical data | SM 1232 AQ 2 x 14 bit | SM 1232 AQ 4 x 14 bit |
|----------------------------------|---|-----------------------|
| Full scale range (data word) | Voltage: -27,648 to 27,648 ; Current: 0 to 27,648 Refer to the output ranges for voltage and current (Page 917). | |
| Accuracy (25 °C / -20 to 60 °C) | ±0.3% / ±0.6% of full scale | |
| Settling time (95% of new value) | Voltage: 300 µS (R), 750 µS (1 uF) Current: 600 µS (1 mH), 2 ms (10 mH) | |
| Load impedance | Voltage: ≥ 1000 Ω Current: ≤ 600 Ω | |
| Behavior on RUN to STOP | Last value or substitute value (default value 0) | |
| Isolation (field side to logic) | none | |
| Cable length (meters) | 100 m twisted and shielded | |

Table A- 147 Diagnostics

| Technical data | SM 1232 AQ 2 x 14 bit | SM 1232 AQ 4 x 14 bit |
|-------------------------------------|-----------------------|-----------------------|
| Overflow/underflow | Yes | Yes |
| Short to ground (voltage mode only) | Yes | Yes |
| Wire break (current mode only) | Yes | Yes |
| 24 VDC low voltage | Yes | Yes |

Table A- 148 Wiring diagrams for the analog output SMs

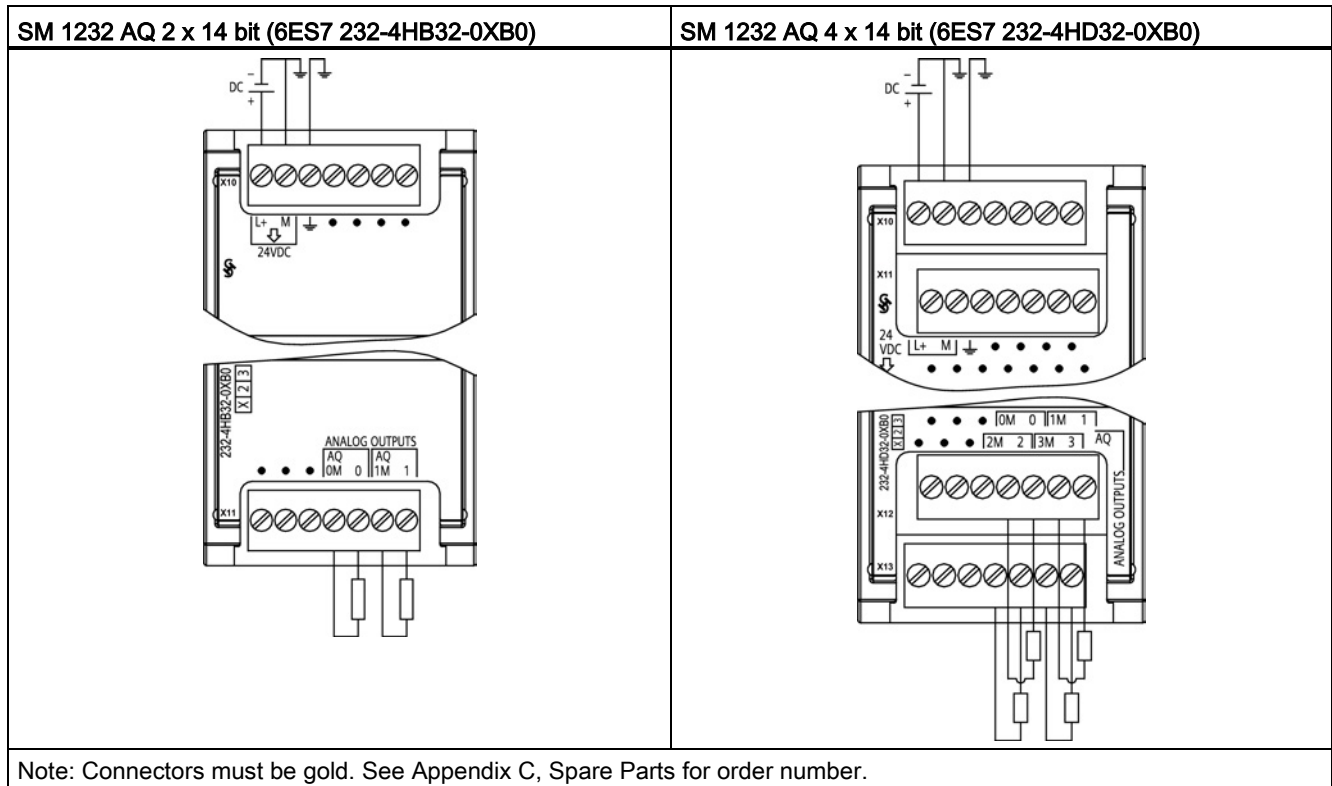

Table A- 149 Connector pin locations for SM 1232 AQ 2 x 14 bit (6ES7 232-4HB32-0XB0)

| Pin | X10 (gold) | X11 (gold) |
|-----|---------------|---------------|
| 1 | L+ / 24 VDC | No connection |
| 2 | M / 24 VDC | No connection |
| 3 | GND | No connection |
| 4 | No connection | AQ 0M |
| 5 | No connection | AQ 0 |
| 6 | No connection | AQ 1M |
| 7 | No connection | AQ 1 |

Table A- 150 Connector pin locations for SM 1232 AQ 4 x 14 bit (6ES7 232-4HD32-0XB0)

| Pin | X10 (gold) | X11 (gold) | X12 (gold) | X13 (gold) |
|-----|---------------|---------------|---------------|---------------|
| 1 | L+ / 24 VDC | No connection | No connection | No connection |
| 2 | M / 24 VDC | No connection | No connection | No connection |
| 3 | GND | No connection | No connection | No connection |
| 4 | No connection | No connection | AQ 0M | AQ 2M |
| 5 | No connection | No connection | AQ 0 | AQ 2 |
| 6 | No connection | No connection | AQ 1M | AQ 3M |
| 7 | No connection | No connection | AQ 1 | AIQ 3 |

A.8.3 SM 1234 analog input/output module specifications

Table A- 151 General specifications

| Technical data | SM 1234 AI 4 x 13 bit / AQ 2 x 14 bit |
|------------------------------|---------------------------------------|
| Order number | 6ES7 234-4HE32-0XB0 |
| Dimensions W x H x D (mm) | 45 x 100 x 75 |
| Weight | 220 grams |
| Power dissipation | 2.4 W |
| Current consumption (SM Bus) | 80 mA |
| Current consumption (24 VDC) | 60 mA (no load) |

Table A- 152 Analog inputs

| Model | SM 1234 AI 4 x 13 bit / AQ 2 x 14 bit |
|--|---|
| Number of inputs | 4 |
| Type | Voltage or Current (differential): Selectable in groups of 2 |
| Range | ± 10 V, ± 5 V, ± 2.5 V, 0 to 20 mA, or 4 mA to 20 mA |
| Full scale range (data word) | -27648 to 27648 |
| Overshoot/undershoot range (data word) | Voltage: 32511 to 27649 / -27649 to -32512 Current: 32511 to 27649 / 0 to -4864 Refer to the section on input ranges for voltage and current (Page 916). |
| Overflow/underflow (data word) | Voltage: 32767 to 32512 / -32513 to -32768 Current: 32767 to 32512 / -4865 to -32768 Refer to the section on input ranges for voltage and current (Page 916). |
| Resolution | 12 bits + sign bit |
| Maximum withstand voltage/current | ± 35 V / ± 40 mA |
| Smoothing | None, weak, medium, or strong Refer to the section on step response times (Page 916). |
| Noise rejection | 400, 60, 50, or 10 Hz Refer to the section on sample rates (Page 916). |

Technical specifications

A.8 Analog signal modules (SMs)

| Model | SM 1234 AI 4 x 13 bit / AQ 2 x 14 bit |
|---------------------------------------|--|
| Input impedance | ≥ 9 MΩ (voltage) / 280 Ω (current) |
| Isolation (field side to logic) | None |
| Accuracy (25 °C / -20 to 60 °C) | ±0.1% / ±0.2% of full scale |
| Analog to digital conversion time | 625 μs (400 Hz rejection) |
| Common mode rejection | 40 dB, DC to 60 Hz |
| Operational signal range ¹ | Signal plus common mode voltage must be less than +12 V and greater than -12 V |
| Cable length (meters) | 100 m, twisted and shielded |

¹ Voltages outside the operational range applied to one channel may cause interference on other channels.

Table A- 153 Analog outputs

| Technical data | SM 1234 AI 4 x 13 bit / AQ 2 x 14 bit |
|----------------------------------|--|
| Number of outputs | 2 |
| Type | Voltage or current |
| Range | ±10 V or 0 to 20 mA |
| Resolution | Voltage: 14 bits ; Current: 13 bits |
| Full scale range (data word) | Voltage: -27648 to 27648; Current: 0 to 27648 Refer to the section on output ranges for voltage and current (Page 917). |
| Accuracy (25 °C / -20 to 60 °C) | ±0.3% / ±0.6% of full scale |
| Settling time (95% of new value) | Voltage: 300 μS (R), 750 μS (1 uF) Current: 600 μS (1 mH), 2 ms (10 mH) |
| Load impedance | Voltage: ≥ 1000 Ω Current: ≤ 600 Ω |
| Behavior on RUN to STOP | Last value or substitute value (default value 0) |
| Isolation (field side to logic) | none |
| Cable length (meters) | 100 m twisted and shielded |

Table A- 154 Diagnostics

| Model | SM 1234 AI 4 x 13 bit / AQ 2 x 14 bit |
|-------------------------------------|---------------------------------------|
| Overflow/underflow | Yes |
| Short to ground (voltage mode only) | Yes on outputs |
| Wire break (current mode only) | Yes on outputs |
| 24 VDC low voltage | Yes |

Table A- 155 Wiring diagrams for the analog input/output SM

| SM 1234 AI 4 x 13 Bit / AQ 2 x 14 bit (6ES7 234-4HE32-0XB0) | |
|---|--|
| | |
| <p>Note: Connectors must be gold. See Appendix C, Spare Parts for order number.</p> | |

Table A- 156 Connector pin locations for SM 1234 AI 4 x 13 Bit / AQ 2 x 14 bit (6ES7 234-4HE32-0XB0)

| Pin | X10 (gold) | X11 (gold) | X12 (gold) | X13 (gold) |
|-----|-------------|---------------|---------------|---------------|
| 1 | L+ / 24 VDC | No connection | No connection | No connection |
| 2 | M / 24 VDC | No connection | No connection | No connection |
| 3 | GND | No connection | No connection | No connection |
| 4 | AI 0+ | AI 2+ | No connection | AQ 0M |
| 5 | AI 0- | AI 2- | No connection | AQ 0 |
| 6 | AI 1+ | AI 3+ | No connection | AQ 1M |
| 7 | AI 1- | AI 3- | No connection | AQ 1 |

Note

Unused voltage input channels should be shorted.

Unused current input channels should be set to the 0 to 20 mA range and/or disable broken wire error reporting.

Inputs configured for current mode will not conduct loop current unless the module is powered and configured.

Current input channels will not operate unless external power is supplied to the transmitter.

A.8.4 Step response of the analog inputs

Table A- 157 Step response (ms), 0 to full-scale measured at 95%

| Smoothing selection (sample averaging) | Noise reduction/rejection frequency (Integration time selection) | | | |
|---|---|--|--|--|
| | 400 Hz (2.5 ms) | 60 Hz (16.6 ms) | 50 Hz (20 ms) | 10 Hz (100 ms) |
| None (1 cycle): No averaging | 4 ms | 18 ms | 22 ms | 100 ms |
| Weak (4 cycles): 4 samples | 9 ms | 52 ms | 63 ms | 320 ms |
| Medium (16 cycles): 16 samples | 32 ms | 203 ms | 241 ms | 1200 ms |
| Strong (32 cycles): 32 samples | 61 ms | 400 ms | 483 ms | 2410 ms |
| Sample time <ul style="list-style-type: none"> • 4 AI x 13 bits • 8 AI x 13 bits • 4 AI4 x 16 bits | <ul style="list-style-type: none"> • 0.625 ms • 1.25 ms • 0.417 ms | <ul style="list-style-type: none"> • 4.17 ms • 4.17 ms • 0.397 ms | <ul style="list-style-type: none"> • 5 ms • 5 ms • 0.400 ms | <ul style="list-style-type: none"> • 25 ms • 25 ms • 0.400 ms |

A.8.5 Sample time and update times for the analog inputs

Table A- 158 Sample time and update time

| Rejection frequency (Integration time) | Sample time | Module update time for all channels | |
|--|--|-------------------------------------|--------------|
| | | 4-channel SM | 8-channel SM |
| 400 Hz (2.5 ms) | <ul style="list-style-type: none"> • 4-channel SM: 0.625 ms • 8-channel SM: 1.250 ms | 0.625 ms | 1.250 ms |
| 60 Hz (16.6 ms) | 4.170 ms | 4.17 ms | 4.17 ms |
| 50 Hz (20 ms) | 5.000 ms | 5 ms | 5 ms |
| 10 Hz (100 ms) | 25.000 ms | 25 ms | 25 ms |

A.8.6 Measurement ranges of the analog inputs for voltage and current (SB and SM)

Table A- 159 Analog input representation for voltage (SB and SM)

| System | | Voltage Measuring Range | | | | |
|---------|-------------|-------------------------|----------|---------|---------|-----------------|
| Decimal | Hexadecimal | ±10 V | ±5 V | ±2.5 V | ±1.25 V | |
| 32767 | 7FFF | 11.851 V | 5.926 V | 2.963 V | 1.481 V | Overflow |
| 32512 | 7F00 | | | | | |
| 32511 | 7EFF | 11.759 V | 5.879 V | 2.940 V | 1.470 V | Overshoot range |
| 27649 | 6C01 | | | | | |
| 27648 | 6C00 | 10 V | 5 V | 2.5 V | 1.250 V | Rated range |
| 20736 | 5100 | 7.5 V | 3.75 V | 1.875 V | 0.938 V | |
| 1 | 1 | 361.7 µV | 180.8 µV | 90.4 µV | 45.2 µV | |

| System | | Voltage Measuring Range | | | |
|---------|-------------|-------------------------|----------|----------|----------|
| Decimal | Hexadecimal | ±10 V | ±5 V | ±2.5 V | ±1.25 V |
| 0 | 0 | 0 V | 0 V | 0 V | 0 V |
| -1 | FFFF | | | | |
| -20736 | AF00 | -7.5 V | -3.75 V | -1.875 V | -0.938 V |
| -27648 | 9400 | -10 V | -5 V | -2.5 V | -1.250 V |
| -27649 | 93FF | | | | |
| -32512 | 8100 | -11.759 V | -5.879 V | -2.940 V | -1.470 V |
| -32513 | 80FF | | | | |
| -32768 | 8000 | -11.851 V | -5.926 V | -2.963 V | -1.481 V |

Table A- 160 Analog input representation for current (SB and SM)

| System | | Current measuring range | |
|---------|-------------|-------------------------|-----------------|
| Decimal | Hexadecimal | 0 mA to 20 mA | 4 mA to 20 mA |
| 32767 | 7FFF | 23.70 mA | 22.96 mA |
| 32512 | 7F00 | | |
| 32511 | 7EFF | 23.52 mA | 22.81 mA |
| 27649 | 6C01 | | |
| 27648 | 6C00 | 20 mA | 20 mA |
| 20736 | 5100 | 15 mA | 16 mA |
| 1 | 1 | 723.4 nA | 4 mA + 578.7 nA |
| 0 | 0 | 0 mA | 4 mA |
| -1 | FFFF | | |
| -4864 | ED00 | -3.52 mA | 1.185 mA |
| -4865 | ECFF | | |
| -32768 | 8000 | | |

A.8.7 Measurement ranges of the analog outputs for voltage and current (SB and SM)

Table A- 161 Analog output representation for voltage (SB and SM)

| System | | Voltage Output Range | |
|---------|-------------|----------------------|-----------------|
| Decimal | Hexadecimal | ± 10 V | |
| 32767 | 7FFF | See note 1 | Overflow |
| 32512 | 7F00 | See note 1 | |
| 32511 | 7EFF | 11.76 V | Overshoot range |
| 27649 | 6C01 | | |
| 27648 | 6C00 | 10 V | Rated range |
| 20736 | 5100 | 7.5 V | |
| 1 | 1 | 361.7 μV | |
| 0 | 0 | 0 V | |

A.9 Thermocouple and RTD signal modules (SMs)

| System | | Voltage Output Range | |
|---------|-------------|----------------------|------------------|
| Decimal | Hexadecimal | ± 10 V | |
| -1 | FFFF | -361.7 µV | |
| -20736 | AF00 | -7.5 V | |
| -27648 | 9400 | -10 V | |
| -27649 | 93FF | | Undershoot range |
| -32512 | 8100 | -11.76 V | Underflow |
| -32513 | 80FF | See note 1 | |
| -32768 | 8000 | See note 1 | |

¹ In an overflow or underflow condition, analog outputs will take on the substitute value of the STOP mode.

Table A- 162 Analog output representation for current (SB and SM)

| System | | Current output range | | |
|---------|-------------|----------------------|------------------|---|
| Decimal | Hexadecimal | 0 mA to 20 mA | 4 mA to 20 mA | |
| 32767 | 7FFF | See note 1 | See note 1 | Overflow |
| 32512 | 7F00 | See note 1 | See note 1 | |
| 32511 | 7EFF | 23.52 mA | 22.81 mA | Overshoot range |
| 27649 | 6C01 | | | |
| 27648 | 6C00 | 20 mA | 20 mA | Rated range |
| 20736 | 5100 | 15 mA | 16 mA | |
| 1 | 1 | 723.4 nA | 4 mA + 578.7 nA | |
| 0 | 0 | 0 mA | 4mA | |
| -1 | FFFF | | 4 mA to 578.7 nA | Undershoot range |
| -6912 | E500 | | 0 mA | |
| -6913 | E4FF | | | Not possible. Output value limited to 0 mA. |
| -32512 | 8100 | | | Underflow |
| -32513 | 80FF | See note 1 | See note 1 | |
| -32768 | 8000 | See note 1 | See note 1 | |

¹ In an overflow or underflow condition, analog outputs will take on the substitute value of the STOP mode.

A.9 Thermocouple and RTD signal modules (SMs)

A.9.1 SM 1231 Thermocouple

Table A- 163 General specifications

| Model | SM 1231 AI 4 x 16 bit TC | SM 1231 AI 8 x 16 bit TC |
|---|--------------------------|--------------------------|
| Order number | 6ES7 231-5QD32-0XB0 | 6ES7 231-5QF32-0XB0 |
| Dimensions W x H x D (mm) | 45 x 100 x 75 | 45 x 100 x 75 |
| Weight | 180 grams | 190 grams |
| Power dissipation | 1.5 W | 1.5 W |
| Current consumption (SM Bus) | 80 mA | 80 mA |
| Current consumption (24 VDC) ¹ | 40 mA | 40 mA |

¹ 20.4 to 28.8 VDC (Class 2, Limited Power, or sensor power from PLC)

Table A- 164 Analog inputs

| Model | SM 1231 AI 4 x 16 bit TC | SM 1231 AI 8 x 16 bit TC |
|----------------------------------|--|--|
| Number of inputs | 4 | 8 |
| Range | See Thermocouple selection table | See Thermocouple selection table |
| Nominal range (data word) | (Page 923). | (Page 923). |
| Overrange/underrange (data word) | | |
| Overflow/underflow (data word) | | |
| Resolution | Temperature | 0.1 °C/0.1 °F |
| | Voltage | 15 bits plus sign |
| Maximum withstand voltage | ± 35 V | ± 35 V |
| Noise rejection | 85 dB for selected filter setting (10 Hz, 50 Hz, 60 Hz or 400 Hz) | 85 dB for selected filter setting (10 Hz, 50 Hz, 60 Hz or 400 Hz) |
| Common mode rejection | > 120 dB at 120 VAC | > 120 dB at 120 VAC |
| Impedance | ≥ 10 MΩ | ≥ 10 MΩ |
| Isolation | Field to logic | 500 VAC |
| | Field to 24 VDC | 500 VAC |
| | 24 VDC to logic | 500 VAC |
| Channel to channel | 120 VAC | 120 VAC |
| Accuracy | See Thermocouple selection table (Page 923). | See Thermocouple selection table (Page 923). |
| Repeatability | ±0.05% FS | ±0.05% FS |
| Measuring principle | Integrating | Integrating |
| Module update time | See Noise reduction selection table (Page 923). | See Noise reduction selection table (Page 923). |
| Cold junction error | ±1.5 °C | ±1.5 °C |

Technical specifications

A.9 Thermocouple and RTD signal modules (SMs)

| Model | SM 1231 AI 4 x 16 bit TC | SM 1231 AI 8 x 16 bit TC |
|-----------------------|---------------------------|---------------------------|
| Cable length (meters) | 100 meters to sensor max. | 100 meters to sensor max. |
| Wire resistance | 100 Ω max. | 100 Ω max. |

Table A- 165 Diagnostics

| Model | SM 1231 AI 4 x 16 bit TC | SM 1231 AI 8 x 16 bit TC |
|---|--------------------------|--------------------------|
| Overflow/underflow ¹ | Yes | Yes |
| Wire break (current mode only) ² | Yes | Yes |
| 24 | Yes | Yes |
| VDC low voltage ¹ | | |

¹ The overflow, underflow and low voltage diagnostic alarm information will be reported in the analog data values even if the alarms are disabled in the module configuration.

² When wire break alarm is disabled and an open wire condition exists in the sensor wiring, the module may report random values.

The SM 1231 Thermocouple (TC) analog signal module measures the value of voltage connected to the module inputs. The temperature measurement type can be either "Thermocouple" or "Voltage".

- "Thermocouple": The value will be reported in degrees multiplied by ten (for example, 25.3 degrees will be reported as decimal 253).
- "Voltage": The nominal range full scale value will be decimal 27648.

Table A- 166 Wiring diagrams for the thermocouple SMs

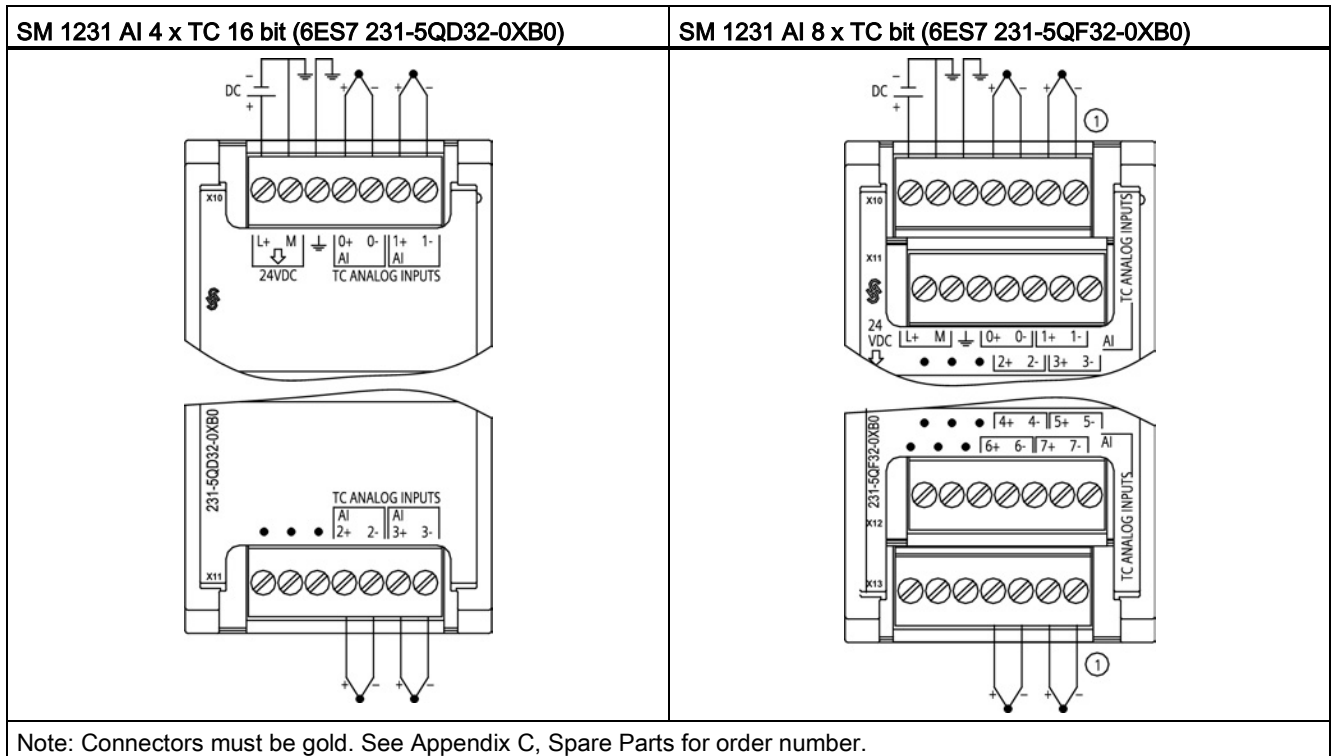

① TC 2, 3, 4, and 5 not shown connected for clarity.

Table A- 167 Connector pin locations for SM 1231 AI 4 x TC 16 bit (6ES7 231-5QD32-0XB0)

| Pin | X10 (gold) | X11 (gold) |
|-----|-------------|---------------|
| 1 | L+ / 24 VDC | No connection |
| 2 | M / 24 VDC | No connection |
| 3 | GND | No connection |
| 4 | AI 0+ /TC | AI 2+ /TC |
| 5 | AI 0- /TC | AI 2- /TC |
| 6 | AI 1+ /TC | AI 3+ /TC |
| 7 | AI 1- /TC | AI 3- /TC |

Table A- 168 Connector Pin Locations for SM 1231 AI 8 x TC bit (6ES7 231-5QF32-0XB0)

| Pin | X10 (gold) | X11 (gold) | X12 (gold) | X13 (gold) |
|-----|-------------|---------------|---------------|---------------|
| 1 | L+ / 24 VDC | No connection | No connection | No connection |
| 2 | M / 24 VDC | No connection | No connection | No connection |
| 3 | GND | No connection | No connection | No connection |
| 4 | AI 0+ /TC | AI 2+ /TC | AI 4 I- /TC | AI 6 I- /TC |
| 5 | AI 0- /TC | AI 2- /TC | AI 4 I+ /TC | AI 6 I+ /TC |
| 6 | AI 1+ /TC | AI 3+ /TC | AI 5 M- /TC | AI 7 M- /TC |
| 7 | AI 1- /TC | AI 3- /TC | AI 5 M+ /TC | AI 7 M+ /TC |

Note

Unused analog inputs should be shorted.

The thermocouple unused channels can be deactivated. No error will occur if an unused channel is deactivated.

A.9.1.1 Basic operation for a thermocouple

Thermocouples are formed whenever two dissimilar metals are electrically bonded to each other. A voltage is generated that is proportional to the junction temperature. This voltage is small; one microvolt could represent many degrees. Measuring the voltage from a thermocouple, compensating for extra junctions, and then linearizing the result forms the basis of temperature measurement using thermocouples.

When you connect a thermocouple to the SM 1231 Thermocouple module, the two dissimilar metal wires are attached to the module at the module signal connector. The place where the two dissimilar wires are attached to each other forms the sensor thermocouple.

Two more thermocouples are formed where the two dissimilar wires are attached to the signal connector. The connector temperature causes a voltage that adds to the voltage from the sensor thermocouple. If this voltage is not corrected, then the temperature reported will deviate from the sensor temperature.

Cold junction compensation is used to compensate for the connector thermocouple. Thermocouple tables are based on a reference junction temperature, usually zero degrees Celsius. The cold junction compensation compensates the connector to zero degrees Celsius. The cold junction compensation restores the voltage added by the connector thermocouples. The temperature of the module is measured internally, and then converted to a value to be added to the sensor conversion. The corrected sensor conversion is then linearized using the thermocouple tables.

For optimum operation of the cold junction compensation, the thermocouple module must be located in a thermally stable environment. Slow variation (less than 0.1 °C/minute) in ambient module temperature is correctly compensated within the module specifications. Air movement across the module will also cause cold junction compensation errors.

If better cold junction error compensation is needed, an external iso-thermal terminal block may be used. The thermocouple module provides for use of a 0 °C referenced or 50 °C referenced terminal block.

A.9.1.2 Selection tables for the SM 1231 thermocouple

The ranges and accuracy for the different thermocouple types supported by the SM 1231 Thermocouple signal module are shown in the table below.

Table A- 169 SM 1231 Thermocouple selection table

| Type | Under-range minimum ¹ | Nominal range low limit | Nominal range high limit | Over-range maximum ² | Normal range ^{3,4} accuracy @ 25 °C | Normal range ^{1,2} accuracy -20 °C to 60 °C |
|-----------|----------------------------------|-------------------------|--------------------------|---------------------------------|--|--|
| J | -210.0 °C | -150.0 °C | 1200.0 °C | 1450.0 °C | ±0.3 °C | ±0.6 °C |
| K | -270.0 °C | -200.0 °C | 1372.0 °C | 1622.0 °C | ±0.4 °C | ±1.0 °C |
| T | -270.0 °C | -200.0 °C | 400.0 °C | 540.0 °C | ±0.5 °C | ±1.0 °C |
| E | -270.0 °C | -200.0 °C | 1000.0 °C | 1200.0 °C | ±0.3 °C | ±0.6 °C |
| R & S | -50.0 °C | 100.0 °C | 1768.0 °C | 2019.0 °C | ±1.0 °C | ±2.5 °C |
| B | 0.0 °C | 200.0 °C | 800.0 °C | -- | ±2.0 °C | ±2.5 °C |
| | -- | 800.0 °C | 1820.0 °C | 1820.0 °C | ±1.0 °C | ±2.3 °C |
| N | -270.0 °C | -200.0 °C | 1300.0 °C | 1550.0 °C | ±1.0 °C | ±1.6 °C |
| C | 0.0 °C | 100.0 °C | 2315.0 °C | 2500.0 °C | ±0.7 °C | ±2.7 °C |
| TXK/XK(L) | -200.0 °C | -150.0 °C | 800.0 °C | 1050.0 °C | ±0.6 °C | ±1.2 °C |
| Voltage | -32512 | -27648 -80mV | 27648 80mV | 32511 | ±0.05% | ±0.1% |

- 1 Thermocouple values below the under-range minimum value are reported as -32768.
- 2 Thermocouple values above the over-range minimum value are reported as 32767.
- 3 Internal cold junction error is ±1.5 °C for all ranges. This adds to the error in this table. The module requires at least 30 minutes of warm-up time to meet this specification.
- 4 In the presence of radiated radio frequency of 970 MHz to 990 MHz, the accuracy of the SM 1231 AI 4 x 16 bit TC may be degraded.

Note

Thermocouple channel

Each channel on the Thermocouple signal module can be configured with a different thermocouple type (selectable in the software during configuration of the module).

A.9 Thermocouple and RTD signal modules (SMs)

Table A- 170 Noise reduction and update times for the SM 1231 Thermocouple

| Rejection frequency selection | Integration time | 4 Channel module update time (seconds) | 8 Channel module update time (seconds) |
|-------------------------------|--------------------|--|--|
| 400 Hz (2.5 ms) | 10 ms ¹ | 0.143 | 0.285 |
| 60 Hz (16.6 ms) | 16.67 ms | 0.223 | 0.445 |
| 50 Hz (20 ms) | 20 ms | 0.263 | 0.525 |
| 10 Hz (100 ms) | 100 ms | 1.225 | 2.450 |

¹ To maintain module resolution and accuracy when 400 Hz rejection is selected, the integration time is 10 ms. This selection also rejects 100 Hz and 200 Hz noise.

It is recommended for measuring thermocouples that a 100 ms integration time be used. The use of smaller integration times will increase the repeatability error of the temperature readings.

Note

After power is applied, the module performs internal calibration for the analog-to-digital converter. During this time the module reports a value of 32767 on each channel until valid data is available on that channel. Your user program may need to allow for this initialization time. Because the configuration of the module can vary the length of the initialization time, you should verify the behavior of the module in your configuration. If required, you can include logic in your user program to accommodate the initialization time of the module.

Representation of analog values for Thermocouple Type J

A representation of the analog values of thermocouples type J is shown in the table below.

Table A- 171 Representation of analog values of thermocouples type J

| Type J in °C | Units | | Type J in °F | Units | | Range |
|--------------|---------|-------------|--------------|---------|-------------|------------------------|
| | Decimal | Hexadecimal | | Decimal | Hexadecimal | |
| > 1450.0 | 32767 | 7FFF | > 2642.0 | 32767 | 7FFF | Overflow |
| 1450.0 | 14500 | 38A4 | 2642.0 | 26420 | 6734 | Overrange |
| : | : | : | : | : | : | |
| 1200.1 | 12001 | 2EE1 | 2192.2 | 21922 | 55A2 | Rated range |
| 1200.0 | 12000 | 2EE0 | 2192.0 | 21920 | 55A0 | |
| : | : | : | : | : | : | |
| -150.0 | -1500 | FA24 | -238.0 | -2380 | F6B4 | Underflow ¹ |
| < -150.0 | -32768 | 8000 | < -238.0 | -32768 | 8000 | |

¹ Faulty wiring (for example, polarity reversal, or open inputs) or sensor error in the negative range (for example, wrong type of thermocouple) may cause the thermocouple module to signal underflow.

A.9.2 SM 1231 RTD

SM 1231 RTD specifications

Table A- 172 General specifications

| Technical data | SM 1231 AI 4 x RTD x 16 bit | SM 1231 AI 8 x RTD x 16 bit |
|---|-----------------------------|-----------------------------|
| Order number | 6ES7 231-5PD32-0XB0 | 6ES7 231-5PF32-0XB0 |
| Dimensions W x H x D (mm) | 45 x 100 x 75 | 70 x 100 x 75 |
| Weight | 220 grams | 270 grams |
| Power dissipation | 1.5 W | 1.5 W |
| Current consumption (SM Bus) | 80 mA | 90 mA |
| Current consumption (24 VDC) ¹ | 40 mA | 40 mA |

¹ 20.4 to 28.8 VDC (Class 2, Limited Power, or sensor power from CPU)

Table A- 173 Analog inputs

| Technical data | SM 1231 AI 4 x RTD x 16 bit | SM 1231 AI 8 x RTD x16 bit |
|--|--|--|
| Number of inputs | 4 | 8 |
| Type | Module referenced RTD and Ω | Module referenced RTD and Ω |
| Range | See RTD Sensor selection table | See RTD Sensor selection table |
| Nominal range (data word) | (Page 928). | (Page 928). |
| Overshoot/undershoot range (data word) | | |
| Overflow/underflow (data word) | | |
| Resolution | | |
| Temperature | 0.1 °C/0.1 °F | 0.1 °C/0.1 °F |
| Resistance | 15 bits plus sign | 15 bits plus sign |
| Maximum withstand voltage | ± 35 V | ± 35 V |
| Noise rejection | 85 dB for the selected noise reduction (10 Hz, 50 Hz, 60 Hz or 400 Hz) | 85 dB for the selected noise reduction (10 Hz, 50 Hz, 60 Hz or 400 Hz) |
| Common mode rejection | > 120dB | > 120dB |
| Impedance | ≥ 10 M Ω | ≥ 10 M Ω |
| Isolation | | |
| Field side to logic | 500 VAC | 500 VAC |
| Field to 24 VDC | 500 VAC | 500 VAC |
| 24 VDC to logic | 500 VAC | 500 VAC |
| Channel to channel isolation | none | none |
| Accuracy | See RTD Sensor selection table (Page 928). | See RTD Sensor selection table (Page 928). |
| Repeatability | ±0.05% FS | ±0.05% FS |
| Maximum sensor dissipation | 0.5 m W | 0.5 m W |
| Measuring principle | Integrating | Integrating |
| Module update time | See Noise reduction selection table (Page 928). | See Noise reduction selection table (Page 928). |

Technical specifications

A.9 Thermocouple and RTD signal modules (SMs)

| Technical data | SM 1231 AI 4 x RTD x 16 bit | SM 1231 AI 8 x RTD x16 bit |
|-----------------------|------------------------------------|-----------------------------------|
| Cable length (meters) | 100 meters to sensor max. | 100 meters to sensor max. |
| Wire resistance | 20 Ω, 2.7 Ω for 10 Ω RTD max. | 20 Ω, 2.7 Ω for 10 Ω RTD max. |

Table A- 174 Diagnostics

| Technical data | SM 1231 AI 4 x RTD x 16 bit | SM 1231 AI 8 x RTD x16 bit |
|-----------------------------------|------------------------------------|-----------------------------------|
| Overflow/underflow ^{1,2} | Yes | Yes |
| Wire break ³ | Yes | Yes |
| 24 VDC low voltage ¹ | Yes | Yes |

¹ The overflow, underflow and low voltage diagnostic alarm information will be reported in the analog data values even if the alarms are disabled in the module configuration.

² For resistance ranges underflow detection is never enabled.

³ When wire break alarm is disabled and an open wire condition exists in the sensor wiring, the module may report random values.

The SM 1231 RTD analog signal module measures the value of resistance connected to the module inputs. The measurement type can be selected as either "Resistor" or "Thermal resistor".

- "Resistor": The nominal range full scale value will be decimal 27648.
- "Thermal resistor": The value will be reported in degrees multiplied by ten (for example, 25.3 degrees will be reported as decimal 253). The climatic range values will be reported in degrees multiplied by one hundred (for example, 25.34 degrees will be reported as decimal 2534).

The SM 1231 RTD module supports measurements with 2-wire, 3-wire and 4-wire connections to the sensor resistor.

Table A- 175 Wiring diagrams for the RTD SMs

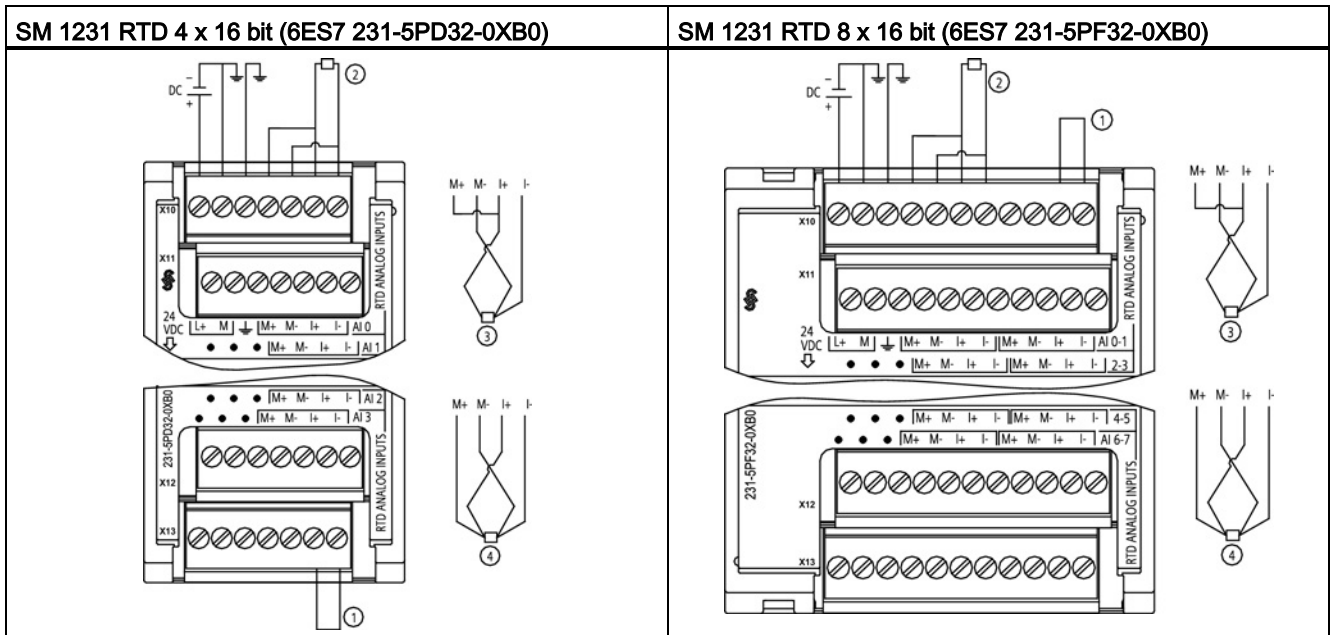

- ① Loop-back unused RTD inputs
- ② 2-wire RTD ③ 3-wire RTD ④ 4-wire RTD

NOTE: Connectors must be gold. See Appendix C, Spare Parts for order number.

Table A- 176 Connector Pin Locations for SM 1231 RTD 4 x 16 bit (6ES7 231-5PD32-0XB0)

| Pin | X10 (gold) | X11 (gold) | X12 (gold) | X13 (gold) |
|-----|--------------|---------------|---------------|---------------|
| 1 | L+ / 24 VDC | No connection | No connection | No connection |
| 2 | M / 24 VDC | No connection | No connection | No connection |
| 3 | GND | No connection | No connection | No connection |
| 4 | AI 0 M+ /RTD | AI 1 M+ /RTD | AI 2 M+ /RTD | AI 3 M+ /RTD |
| 5 | AI 0 M- /RTD | AI 1 M- /RTD | AI 2 M- /RTD | AI 3 M- /RTD |
| 6 | AI 0 I+ /RTD | AI 1 I+ /RTD | AI 2 I+ /RTD | AI 3 I+ /RTD |
| 7 | AI 0 I- /RTD | AI 1 I- /RTD | AI 2 I- /RTD | AI 3 I- /RTD |

Table A- 177 Connector Pin Locations for SM 1231 RTD 8 x 16 bit (6ES7 231-5PF32-0XB0)

| Pin | X10 (gold) | X11 (gold) | X12 (gold) | X13 (gold) |
|-----|--------------|---------------|---------------|---------------|
| 1 | L+ / 24 VDC | No connection | No connection | No connection |
| 2 | M / 24 VDC | No connection | No connection | No connection |
| 3 | GND | No connection | No connection | No connection |
| 4 | AI 0 M+ /RTD | AI 2 M+ /RTD | AI 4 M+ /RTD | AI 6 M+ /RTD |
| 5 | AI 0 M- /RTD | AI 2 M- /RTD | AI 4 M- /RTD | AI 6 M- /RTD |
| 6 | AI 0 I+ /RTD | AI 2 I+ /RTD | AI 4 I+ /RTD | AI 6 I+ /RTD |

A.9 Thermocouple and RTD signal modules (SMs)

| Pin | X10 (gold) | X11 (gold) | X12 (gold) | X13 (gold) |
|-----|--------------|--------------|--------------|--------------|
| 7 | AI 0 I- /RTD | AI 2 I- /RTD | AI 4 I- /RTD | AI 6 I- /RTD |
| 8 | AI 1 M+ /RTD | AI 3 M+ /RTD | AI 5 M+ /RTD | AI 7 M+ /RTD |
| 9 | AI 1 M- /RTD | AI 3 M- /RTD | AI 5 M- /RTD | AI 7 M- /RTD |
| 10 | AI 1 I+ /RTD | AI 3 I+ /RTD | AI 5 I+ /RTD | AI 7 I+ /RTD |
| 11 | AI 1 I- /RTD | AI 3 I- /RTD | AI 5 I- /RTD | AI 7 I- /RTD |

Note

The RTD unused channels can be deactivated. No error will occur if an unused channel is deactivated.

The RTD module needs to have the current loop continuous to eliminate extra stabilization time which is automatically added to an unused channel that is not deactivated. For consistency the RTD module should have a resistor connected (like the 2-wire RTD connection).

A.9.2.1 Selection tables for the SM 1231 RTD

Table A- 178 Ranges and accuracy for the different sensors supported by the RTD modules

| Temperature coefficient | RTD type | Under range minimum ¹ | Nominal range low limit | Nominal range high limit | Over range maximum ² | Normal range accuracy @ 25 °C | Normal range accuracy -20 °C to 60 °C |
|---|-----------------|----------------------------------|-------------------------|--------------------------|---------------------------------|-------------------------------|---------------------------------------|
| Pt 0.003850 ITS90 DIN EN 60751 | Pt 100 climatic | -145.00 °C | -120.00 °C | 145.00 °C | 155.00 °C | ±0.20 °C | ±0.40 °C |
| | Pt 10 | -243.0 °C | -200.0 °C | 850.0 °C | 1000.0 °C | ±1.0 °C | ±2.0 °C |
| | Pt 50 | -243.0 °C | -200.0 °C | 850.0 °C | 1000.0 °C | ±0.5 °C | ±1.0 °C |
| | Pt 100 | | | | | | |
| | Pt 200 | | | | | | |
| | Pt 500 | | | | | | |
| Pt 1000 | | | | | | | |
| Pt 0.003902 Pt 0.003916 Pt 0.003920 | Pt 100 | -243.0 °C | -200.0 °C | 850.0 °C | 1000.0 °C | ± 0.5 °C | ±1.0 °C |
| | Pt 200 | -243.0 °C | -200.0 °C | 850.0 °C | 1000.0 °C | ± 0.5 °C | ±1.0 °C |
| | Pt 500 | | | | | | |
| | Pt 1000 | | | | | | |
| Pt 0.003910 | Pt 10 | -273.2 °C | -240.0 °C | 1100.0 °C | 1295 °C | ±1.0 °C | ±2.0 °C |
| | Pt 50 | -273.2 °C | -240.0 °C | 1100.0 °C | 1295 °C | ±0.8 °C | ±1.6 °C |
| | Pt 100 | | | | | | |
| | Pt 500 | | | | | | |

| Temperature coefficient | RTD type | Under range minimum ¹ | Nominal range low limit | Nominal range high limit | Over range maximum ² | Normal range accuracy @ 25 °C | Normal range accuracy -20 °C to 60 °C |
|----------------------------|------------|----------------------------------|-------------------------|--------------------------|---------------------------------|-------------------------------|---------------------------------------|
| Ni 0.006720 Ni 0.006180 | Ni 100 | -105.0 °C | -60.0 °C | 250.0 °C | 295.0 °C | ±0.5 °C | ±1.0 °C |
| | Ni 120 | | | | | | |
| | Ni 200 | | | | | | |
| | Ni 500 | | | | | | |
| | Ni 1000 | | | | | | |
| LG-Ni 0.005000 | LG-Ni 1000 | -105.0 °C | -60.0 °C | 250.0 °C | 295.0 °C | ±0.5 °C | ±1.0 °C |
| Ni 0.006170 | Ni 100 | -105.0 °C | -60.0 °C | 180.0 °C | 212.4 °C | ±0.5 °C | ±1.0 °C |
| Cu 0.004270 | Cu 10 | -240.0 °C | -200.0 °C | 260.0 °C | 312.0 °C | ±1.0 °C | ±2.0 °C |
| Cu 0.004260 | Cu 10 | -60.0 °C | -50.0 °C | 200.0 °C | 240.0 °C | ±1.0 °C | ±2.0 °C |
| | Cu 50 | | | | | | |
| | Cu 100 | | | | | | |
| Cu 0.004280 | Cu 10 | -240.0 °C | -200.0 °C | 200.0 °C | 240.0 °C | ±1.0 °C | ±2.0 °C |
| | Cu 50 | -240.0 °C | -200.0 °C | 200.0 °C | 240.0 °C | ±0.7 °C | ±1.4 °C |
| | Cu 100 | | | | | | |

¹ RTD values below the under-range minimum value report -32768.

² RTD values above the over-range maximum value report +32767.

Table A- 179 Resistance

| Range | Under range minimum | Nominal range low limit | Nominal range high limit | Over range maximum ¹ | Normal range accuracy @ 25 °C | Normal range accuracy -20 °C to 60 °C |
|-------|---------------------|-------------------------|--------------------------|---------------------------------|-------------------------------|---------------------------------------|
| 150 Ω | n/a | 0 (0 Ω) | 27648 (150 Ω) | 176.383 Ω | ±0.05% | ±0.1% |
| 300 Ω | n/a | 0 (0 Ω) | 27648 (300 Ω) | 352.767 Ω | ±0.05% | ±0.1% |
| 600 Ω | n/a | 0 (0 Ω) | 27648 (600 Ω) | 705.534 Ω | ±0.05% | ±0.1% |

¹ Resistance values above the over-range minimum value are reported as +32767.

Note

The module reports 32767 on any activated channel with no sensor connected. If open wire detection is also enabled, the module flashes the appropriate red LEDs.

When 500 Ω and 1000 Ω RTD ranges are used with other lower value resistors, the error may increase to two times the specified error.

Best accuracy will be achieved for the 10 Ω RTD ranges if 4 wire connections are used.

The resistance of the connection wires in 2 wire mode will cause an error in the sensor reading and therefore accuracy is not guaranteed.

A.9 Thermocouple and RTD signal modules (SMs)

Table A- 180 Noise reduction and update times for the RTD modules

| Rejection frequency selection | Integration time | Update time (seconds) | |
|-------------------------------|--------------------|-----------------------------------|-----------------------------------|
| | | 4-channel module | 8-channel module |
| 400 Hz (2.5 ms) | 10 ms ¹ | 4-/2-wire: 0.142 3-wire: 0.285 | 4-/2-wire: 0.285 3-wire: 0.525 |
| 60 Hz (16.6 ms) | 16.67 ms | 4-/2-wire: 0.222 3-wire: 0.445 | 4-/2-wire: 0.445 3-wire: 0.845 |
| 50 Hz (20 ms) | 20 ms | 4-/2-wire: 0.262 3-wire: .505 | 4-/2-wire: 0.524 3-wire: 1.015 |
| 10 Hz (100 ms) | 100 ms | 4-/2-wire: 1.222 3-wire: 2.445 | 4-/2-wire: 2.425 3-wire: 4.845 |

¹ To maintain module resolution and accuracy when the 400 Hz filter is selected, the integration time is 10 ms. This selection also rejects 100 Hz and 200 Hz noise.

Note

After power is applied, the module performs internal calibration for the analog-to-digital converter. During this time the module reports a value of 32767 on each channel until valid data is available on that channel. Your user program may need to allow for this initialization time. Because the configuration of the module can vary the length of the initialization time, you should verify the behavior of the module in your configuration. If required, you can include logic in your user program to accommodate the initialization time of the module.

Representation of Analog values for RTDs

A representation of the digitized measured value for the RTD standard temperature range sensors are shown in the tables below.

Table A- 181 Representation of analog values for resistance thermometers PT 100, 200, 500, 1000 and PT 10, 50, 100, 500 GOST (0.003850) standard

| Pt x00 standard in °C (1 digit = 0.1 °C) | Units | | Pt x00 standard in °F (1 digit = 0.1 °F) | Units | | Range |
|--|---------|-------------|--|---------|-------------|-------------|
| | Decimal | Hexadecimal | | Decimal | Hexadecimal | |
| > 1000.0 | 32767 | 7FFF | > 1832.0 | 32767 | 7FFF | Overflow |
| 1000.0 | 10000 | 2710 | 1832.0 | 18320 | 4790 | Overrange |
| : | : | : | : | : | : | |
| 850.1 | 8501 | 2135 | 1562.1 | 15621 | 3D05 | Rated range |
| 850.0 | 8500 | 2134 | 1562.0 | 15620 | 3D04 | |
| : | : | : | : | : | : | |
| -200.0 | -2000 | F830 | -328.0 | -3280 | F330 | |

| Pt x00 standard in °C (1 digit = 0.1 °C) | Units | | Pt x00 standard in °F (1 digit = 0.1 °F) | Units | | Range |
|---|------------|-------------|---|------------|-------------|------------|
| | Decimal | Hexadecimal | | Decimal | Hexadecimal | |
| -200.1 : | -2001 : | F82F : | -328.1 : | -3281 : | F32F : | Underrange |
| -243.0 | -2430 | F682 | -405.4 | -4054 | F02A | |
| < -243.0 | -32768 | 8000 | < -405.4 | -32768 | 8000 | Underflow |

A.10 Technology modules

A.10.1 SM 1278 4xIO-Link Master SM

A.10.1.1 SM 1278 4xIO-Link Master signal module specifications

Table A- 182 General specifications

| Technical data | SM 1278 4xIO-Link Master signal module |
|------------------------------|--|
| Order number | 6ES7 278-4BD32-0XB0 |
| Dimensions W x H x D (mm) | 45 x 100 x 75 |
| Weight | 150 grams |
| General information | |
| I&M data | Yes; IM0 to IM3 |
| Supply voltage | |
| Rated voltage (DC) | 24 VDC |
| Valid range low limit (DC) | 19.2 V; 20.5 V if IO-Link is used (the supply voltage for IO-Link devices on the master must be at least 20 V) |
| Valid range high limit (DC) | 28.8 VDC |
| Polarity reversal protection | Yes |
| Input current | |
| Current consumption | 65 mA; without load |
| Encoder supply | |
| Number of outputs | 4 |
| Output current, rated value | 200 mA |
| Power loss | |
| Power loss, typ. | 1 W, excluding port loading |
| Digital inputs/outputs | |
| Cable length (meters) | 20 m, unshielded, max. |
| SDLC | |
| Cable length (meters) | 20 m, unshielded, max. |

Technical specifications

A.10 Technology modules

| Technical data | SM 1278 4xIO-Link Master signal module |
|--|---|
| IO-Link | |
| Number of ports | 4 |
| Number of ports which can be controlled at the same time | 4 |
| IO-Link protocol 1.0 | Yes |
| IO-Link protocol 1.1 | Yes |
| Operating mode | |
| IO-Link | Yes |
| DI | Yes |
| DQ | Yes; max. 100 mA |
| Connection of IO-Link devices | |
| Port type A | Yes |
| Transmission rate | 4.8 kBd (COM1) 38.4 kBd (COM2) 230.4 kBd (COM3) |
| Cycle time, min. | 2 ms, dynamic, dependent on the user data length |
| Size of process data, input per port | 32 bytes; max. |
| Size of process data, input per module | 32 bytes |
| Size of process data, output per port | 32 bytes; max. |
| Size of process data, output per module | 32 bytes |
| Memory size for device parameters | 2 Kbytes |
| Cable length unshielded, max. (meters) | 20 m |
| Interrupts/diagnostics/status information | |
| Status display | Yes |
| Interrupts | |
| Diagnostic interrupt | Yes; port diagnostics is only available in IO-Link mode |
| Diagnostic alarms | |
| Diagnostics | |
| Monitoring of supply voltage | Yes |
| Short circuit | Yes |
| Diagnostic indicator LED | |
| Monitoring of supply voltage | Yes; flashing red DIAG LED |
| Channel status display | Yes; per channel one green LED for channel status Qn (SIO mode) and PORT status Cn (IO-Link mode) |
| For channel diagnostics | Yes; red Fn LED |
| For module diagnostics | Yes; green/red DIAG LED |
| Electrical isolation | |
| Electrical isolation channels | |
| Between the channels | No |
| Between the channels and the backplane bus | Yes |
| Permitted potential difference | |

| Technical data | SM 1278 4xIO-Link Master signal module |
|--------------------------------|--|
| Between the different circuits | 75 VDC / 60 VAC (basic insulation) |
| Insulation | |
| Insulation tested with | 707 VDC (type test) |
| Ambient conditions | |
| Operating temperature | |
| Min. | -20 °C |
| Max. | 60 °C |
| Horizontal installation, min. | -20 °C |
| Horizontal installation, max. | 60 °C |
| Vertical installation, min. | -20 °C |
| Vertical installation, max. | 50 °C |

Overview of the response time

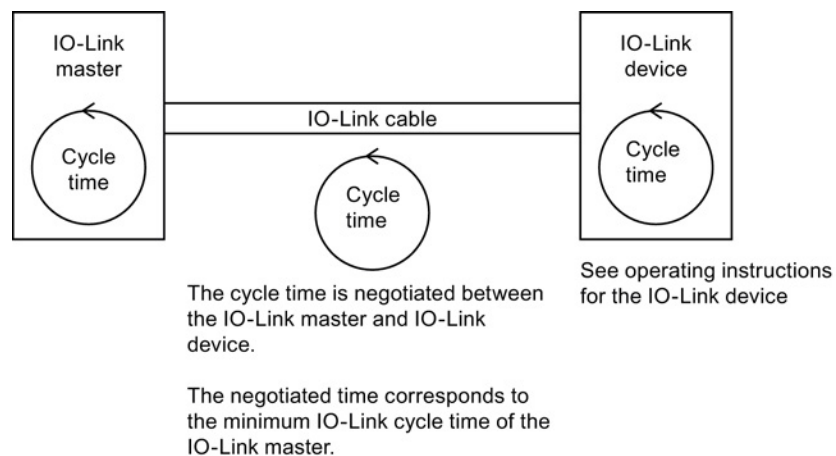

A.10.1.2 SM 1278 4xIO-Link Master SM wiring diagrams

Table A- 183 Wiring diagram for the SM 1278 IO-Link Master

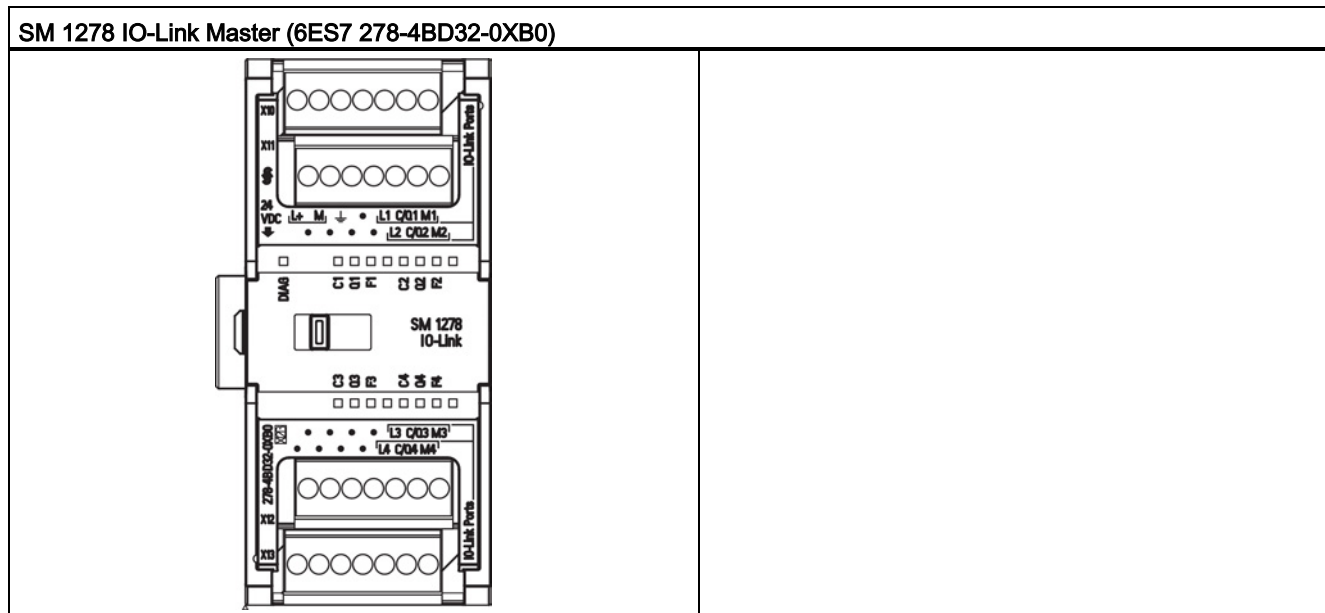

Table A- 184 Connector pin locations for SM 1278 IO-Link Master (6ES7 278-4BD32-0XB0)

| Pin | X10 | X11 | X12 | X13 |
|-----|------------------|-------------------|------------------|-------------------|
| 1 | L+ / 24 VDC | No connection | No connection | No connection |
| 2 | M / 24 VDC | No connection | No connection | No connection |
| 3 | Functional Earth | No connection | No connection | No connection |
| 4 | No connection | No connection | No connection | No connection |
| 5 | L ₁ | L ₂ | L ₃ | L ₄ |
| 6 | C/Q ₁ | C/QL ₂ | C/Q ₃ | C/QL ₄ |
| 7 | ML ₁ | ML ₂ | M ₃ | ML ₄ |

A.11 Digital signal boards (SBs)

A.11.1 SB 1221 200 kHz digital input specifications

Table A- 185 General specifications

| Technical data | SB 1221 DI 4 x 24 VDC, 200 kHz | SB 1221 DI 4 x 5 VDC, 200 kHz |
|------------------------------|---------------------------------------|--------------------------------------|
| Order number | 6ES7 221-3BD30-0XB0 | 6ES7 221-3AD30-0XB0 |
| Dimensions W x H x D (mm) | 38 x 62 x 21 | 38 x 62 x 21 |
| Weight | 35 grams | 35 grams |
| Power dissipation | 1.5 W | 1.0 W |
| Current consumption (SM Bus) | 40 mA | 40 mA |
| Current consumption (24 VDC) | 7 mA / input + 20 mA | 15 mA / input + 15 mA |

Table A- 186 Digital inputs

| Technical data | SB 1221 DI 4 x 24 VDC, 200 kHz | SB 1221 DI 4 x 5 VDC, 200 kHz |
|------------------------------------|---|---|
| Number of inputs | 4 | 4 |
| Type | Source | Source |
| Rated voltage | 24 VDC at 7 mA, nominal | 5 VDC at 15 mA, nominal |
| Continuous permissible voltage | 28.8 VDC | 6 VDC |
| Surge voltage | 35 VDC for 0.5 sec. | 6 V |
| Logic 1 signal (min.) | L+ minus 10 VDC at 2.9 mA | L+ minus 2.0 VDC at 5.1 mA |
| Logic 0 signal (max.) | L+ minus 5 VDC at 1.4 mA | L+ minus 1.0 VDC at 2.2 mA |
| HSC clock input rates (max.) | Single phase: 200 kHz Quadrature phase: 160 kHz | Single phase: 200 kHz Quadrature phase: 160 kHz |
| Isolation (field side to logic) | 500 VAC for 1 minute | 500 VAC for 1 minute |
| Isolation groups | 1 | 1 |
| Filter times | us settings | 0.1, 0.2, 0.4, 0.8, 1.6, 3.2, 6.4, 10.0, 12.8, 20.0 |
| | ms settings | 0.05, 0.1, 0.2, 0.4, 0.8, 1.6, 3.2, 6.4, 10.0, 12.8, 20.0 |
| Number of inputs on simultaneously | <ul style="list-style-type: none"> • 2 (no adjacent points) at 60 °C horizontal or 50 °C vertical • 4 at 55 °C horizontal or 45 °C vertical | 4 |
| Cable length (meters) | 50 shielded twisted pair | 50 shielded twisted pair |

Note

When switching frequencies above 20 kHz, it is important that the digital inputs receive a square wave. Consider the following options to improve the signal quality to the inputs:

- Minimize the cable length
- Change a driver from a sink only driver to a sinking and sourcing driver
- Change to a higher quality cable
- Reduce the circuit/components from 24 V to 5 V
- Add an external load at the input

Table A- 187 Wiring diagrams for the 200 kHz digital input SBs

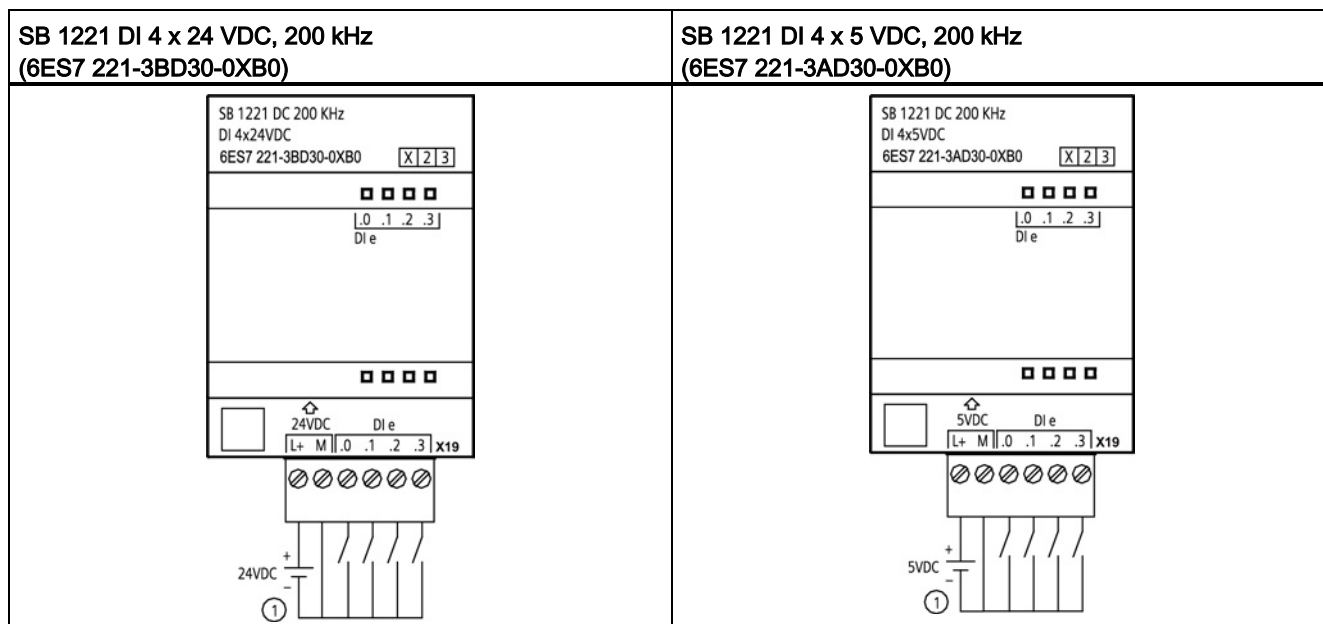

① Supports sourcing inputs only

Table A- 188 Connector pin locations for SB 1221 DI 4 x 24 VDC, 200 kHz (6ES7 221-3BD30-0XB0)

| Pin | X19 |
|-----|-------------|
| 1 | L+ / 24 VDC |
| 2 | M / 24 VDC |
| 3 | DI e.0 |
| 4 | DI e.1 |
| 5 | DI e.2 |
| 6 | DI e.3 |

Table A- 189 Connector pin locations for SB 1221 DI 4 x 5 VDC, 200 kHz (6ES7 221-3AD30-0XB0)

| Pin | X19 |
|-----|------------|
| 1 | L+ / 5 VDC |
| 2 | M / 5 VDC |
| 3 | DI e.0 |
| 4 | DI e.1 |
| 5 | DI e.2 |
| 6 | DI e.3 |

A.11.2 SB 1222 200 kHz digital output specifications

Table A- 190 General specifications

| Technical data | SB 1222 DQ 4 x 24 VDC, 200 kHz | SB 1222 DQ 4 x 5 VDC, 200 kHz |
|------------------------------|--------------------------------|-------------------------------|
| Order number | 6ES7 222-1BD30-0XB0 | 6ES7 222-1AD30-0XB0 |
| Dimensions W x H x D (mm) | 38 x 62 x 21 | 38 x 62 x 21 |
| Weight | 35 grams | 35 grams |
| Power dissipation | 0.5 W | 0.5 W |
| Current consumption (SM Bus) | 35 mA | 35 mA |
| Current consumption (24 VDC) | 15 mA | 15 mA |

Table A- 191 Digital outputs

| Technical data | SB 1222 DQ 4 x 24 VDC, 200 kHz | SB 1222 DQ 4 x 5 VDC, 200 kHz |
|---------------------------------|---|---|
| Number of outputs | 4 | 4 |
| Output type | Solid state - MOSFET sink and source ¹ | Solid state - MOSFET sink and source ¹ |
| Voltage range | 20.4 to 28.8 VDC | 4.25 to 6.0 VDC |
| Logic 1 signal at max. current | L+ minus 1.5 V | L+ minus 0.7 V |
| Logic 0 signal at max. current | 1.0 VDC, max. | 0.2 VDC, max. |
| Current (max.) | 0.1 A | 0.1 A |
| Lamp load | -- | -- |
| On state contact resistance | 11 Ω max. | 7 Ω max. |
| Off state resistance | 6 Ω max. | 0.2 Ω max. |
| Leakage current per point | -- | -- |
| Pulse Train Output rate | 200 kHz max., 2 Hz min. | 200 kHz max., 2 Hz min. |
| Surge current | 0.11 A | 0.11 A |
| Overload protection | No | No |
| Isolation (field side to logic) | 500 VAC for 1 minute | 500 VAC for 1 minute |
| Isolation groups | 1 | 1 |
| Currents per common | 0.4 A | 0.4 A |

Technical specifications

A.11 Digital signal boards (SBs)

| Technical data | SB 1222 DQ 4 x 24 VDC, 200 kHz | SB 1222 DQ 4 x 5 VDC, 200 kHz |
|-------------------------------------|--|--|
| Inductive clamp voltage | None | None |
| Switching delay | 1.5 μ s + 300 ns rise 1.5 μ s + 300 ns fall | 200 ns + 300 ns rise 200 ns + 300 ns fall |
| Behavior on RUN to STOP | Last value or substitute value (default value 0) | Last value or substitute value (default value 0) |
| Number of outputs on simultaneously | <ul style="list-style-type: none">• 2 (no adjacent points) at 60 °C horizontal or 50 °C vertical• 4 at 55 °C horizontal or 45 °C vertical | 4 |
| Cable length (meters) | 50 shielded twisted pair | 50 shielded twisted pair |

¹ Because both sinking and sourcing configurations are supported by the same circuitry, the active state of a sourcing load is opposite that of a sinking load. A source output exhibits positive logic (Q bit and LED are ON when the load has current flow), while a sink output exhibits negative logic (Q bit and LED are OFF when the load has current flow). If the module is plugged in with no user program, the default for this module is 0 V, which means that a sinking load will be turned ON.

Note

When switching frequencies above 20 kHz, it is important that the digital inputs receive a square wave. Consider the following options to improve the signal quality to the inputs:

- Minimize the cable length
- Change a driver from a sink only driver to a sinking and sourcing driver
- Change to a higher quality cable
- Reduce the circuit/components from 24 V to 5 V
- Add an external load at the input

Table A- 192 Wiring diagrams for the 200 kHz digital output SBs

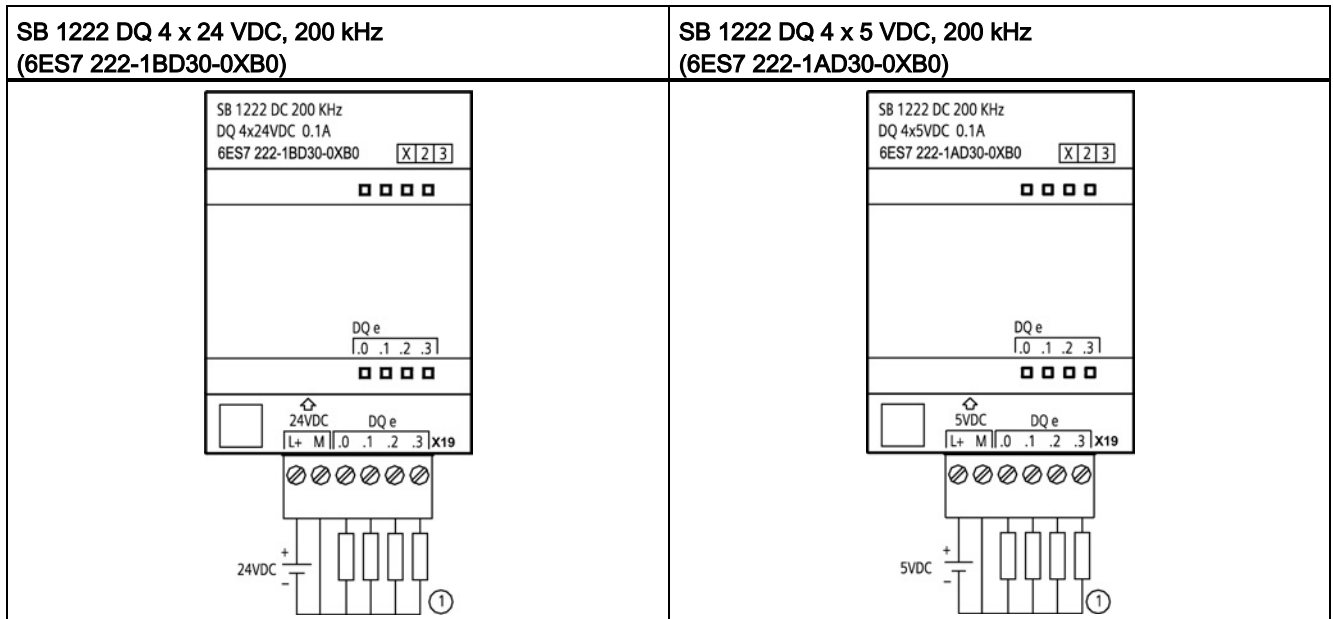

① For sourcing outputs, connect "Load" to "-" (shown). For sinking outputs, connect "Load" to "+". Because both sinking and sourcing configurations are supported by the same circuitry, the active state of a sourcing load is opposite that of a sinking load. A source output exhibits positive logic (Q bit and LED are ON when the load has current flow), while a sink output exhibits negative logic (Q bit and LED are OFF when the load has current flow). If the module is plugged in with no user program, the default for this module is 0 V, which means that a sinking load will be turned ON.

Table A- 193 Connector pin locations for SB 1222 DQ 4 x 24 VDC, 200 kHz (6ES7 222-1BD30-0XB0)

| Pin | X19 |
|-----|-------------|
| 1 | L+ / 24 VDC |
| 2 | M / 24 VDC |
| 3 | DQ e.0 |
| 4 | DQ e.1 |
| 5 | DQ e.2 |
| 6 | DQ e.3 |

Table A- 194 Connector pin locations for SB 1222 DQ 4 x 5 VDC, 200 kHz (6ES7 222-1AD30-0XB0)

| Pin | X19 |
|-----|------------|
| 1 | L+ / 5 VDC |
| 2 | M / 5 VDC |
| 3 | DQ e.0 |
| 4 | DQ e.1 |
| 5 | DQ e.2 |
| 6 | DQ e.3 |

A.11.3 SB 1223 200 kHz digital input / output specifications

Table A- 195 General specifications

| Technical data | SB 1223 DI 2 x 24 VDC / DQ 2 x 24 VDC, 200 kHz | SB 1223 DI 2 x 5 VDC / DQ 2 x 5 VDC, 200 kHz |
|------------------------------|---|---|
| Order number | 6ES7 223-3BD30-0XB0 | 6ES7 223-3AD30-0XB0 |
| Dimensions W x H x D (mm) | 38 x 62 x 21 | 38 x 62 x 21 |
| Weight | 35 grams | 35 grams |
| Power dissipation | 1.0 W | 0.5 W |
| Current consumption (SM Bus) | 35 mA | 35 mA |
| Current consumption (24 VDC) | 7 mA / Input + 30 mA | 15 mA / input + 15 mA |

Table A- 196 Digital inputs

| Technical data | SB 1223 DI 2 x 24 VDC / DQ 2 x 24 VDC, 200 kHz | SB 1223 DI 2 x 5 VDC / DQ 2 x 5 VDC, 200 kHz |
|------------------------------------|--|--|
| Number of inputs | 2 | 2 |
| Type | Source | Source |
| Rated voltage | 24 VDC at 7 mA, nominal | 5 VDC at 15 mA, nominal |
| Continuous permissible voltage | 28.8 VDC | 6 VDC |
| Surge voltage | 35 VDC for 0.5 sec. | 6 V |
| Logic 1 signal (min.) | L+ minus 10 VDC at 2.9 mA | L+ minus 2.0 VDC at 5.1 mA |
| Logic 0 signal (max.) | L+ minus 5 VDC at 1.4 mA | L+ minus 1.0 VDC at 2.2 mA |
| HSC clock input rates (max.) | Single phase: 200 kHz Quadrature phase: 160 kHz | Single phase: 200 kHz Quadrature phase: 160 kHz |
| Isolation (field side to logic) | 500 VAC for 1 minute | 500 VAC for 1 minute |
| Isolation groups | 1 (no isolation to outputs) | 1 (no isolation to outputs) |
| Filter times | us settings | 0.1, 0.2, 0.4, 0.8, 1.6, 3.2, 6.4, 10.0, 12.8, 20.0 |
| | ms settings | 0.05, 0.1, 0.2, 0.4, 0.8, 1.6, 3.2, 6.4, 10.0, 12.8, 20.0 |
| Number of inputs on simultaneously | 2 | 2 |
| Cable length (meters) | 50 shielded twisted pair | 50 shielded twisted pair |

Table A- 197 Digital outputs

| Technical data | SB 1223 DI 2 x 24 VDC / DQ 2 x 24 VDC, 200 kHz | SB 1223 DI 2 x 5 VDC / DQ 2 x 5 VDC, 200 kHz |
|-------------------------------------|---|---|
| Number of outputs | 2 | 2 |
| Output type | Solid state - MOSFET sink and source ¹ | Solid state - MOSFET sink and source ¹ |
| Voltage range | 20.4 to 28.8 VDC | 4.25 to 6.0 VDC |
| Rated value | 24 VDC | 5 VDC |
| Logic 1 signal at max. current | L+ minus 1.5 V | L+ minus 0.7 V |
| Logic 0 signal at max. current | 1.0 VDC, max. | 0.2 VDC, max. |
| Current (max.) | 0.1 A | 0.1 A |
| Lamp load | -- | -- |
| On state contact resistance | 11 Ω max. | 7 Ω max. |
| Off state resistance | 6 Ω max. | 0.2 Ω max. |
| Leakage current per point | -- | -- |
| Pulse Train Output rate | 200 kHz max., 2 Hz min. | 200 kHz max., 2 Hz min. |
| Surge current | 0.11 A | 0.11 A |
| Overload protection | No | No |
| Isolation (field side to logic) | 500 VAC for 1 minute | 500 VAC for 1 minute |
| Isolation groups | 1 (no isolation to inputs) | 1 (no isolation to inputs) |
| Currents per common | 0.2 A | 0.2 A |
| Inductive clamp voltage | None | None |
| Switching delay | 1.5 μs + 300 ns rise 1.5 μs + 300 ns fall | 200 ns + 300 ns rise 200 ns + 300 ns fall |
| Behavior on RUN to STOP | Last value or substitute (default value 0) | Last value or substitute (default value 0) |
| Number of outputs on simultaneously | 2 | 2 |
| Cable length (meters) | 50 shielded twisted pair | 50 shielded twisted pair |

¹ Because both sinking and sourcing configurations are supported by the same circuitry, the active state of a sourcing load is opposite that of a sinking load. A source output exhibits positive logic (Q bit and LED are ON when the load has current flow), while a sink output exhibits negative logic (Q bit and LED are OFF when the load has current flow). If the module is plugged in with no user program, the default for this module is 0 V, which means that a sinking load will be turned ON.

Note

When switching frequencies above 20 kHz, it is important that the digital inputs receive a square wave. Consider the following options to improve the signal quality to the inputs:

- Minimize the cable length
- Change a driver from a sink only driver to a sinking and sourcing driver
- Change to a higher quality cable
- Reduce the circuit/components from 24 V to 5 V
- Add an external load at the input

A.11 Digital signal boards (SBs)

Table A- 198 Wiring diagrams for the 200 kHz digital input/output SBs

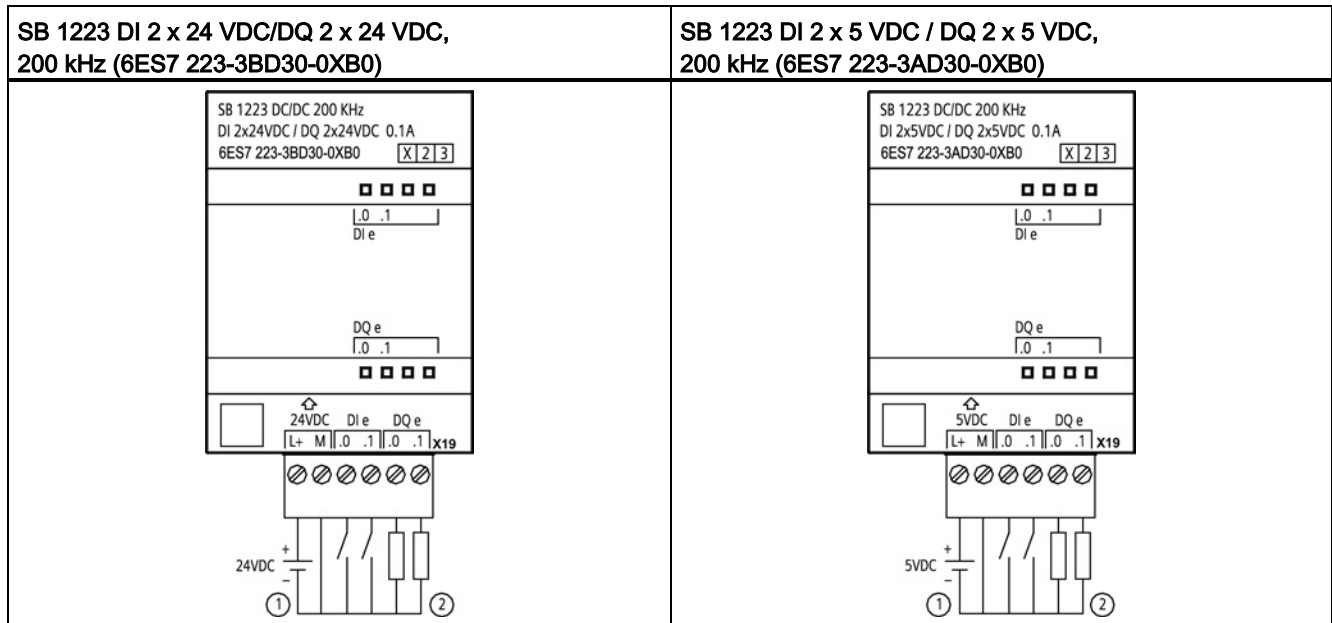

① Supports sourcing inputs only

② For sourcing outputs, connect "Load" to "-" (shown). For sinking outputs, connect "Load" to "+". ¹ Because both sinking and sourcing configurations are supported by the same circuitry, the active state of a sourcing load is opposite that of a sinking load. A source output exhibits positive logic (Q bit and LED are ON when the load has current flow), while a sink output exhibits negative logic (Q bit and LED are OFF when the load has current flow). If the module is plugged in with no user program, the default for this module is 0 V, which means that a sinking load will be turned ON.

Table A- 199 Connector pin locations for SB 1223 DI 2 x 24 VDC/DQ 2 x 24 VDC, 200 kHz (6ES7 223-3BD30-0XB0)

| Pin | X19 |
|-----|-------------|
| 1 | L+ / 24 VDC |
| 2 | M / 24 VDC |
| 3 | DI e.0 |
| 4 | DI e.1 |
| 5 | DQ e.0 |
| 6 | DQ e.1 |

Table A- 200 Connector pin locations for SB 1223 DI 2 x 5 VDC / DQ 2 x 5 VDC, 200 kHz (6ES7 223-3AD30-0XB0)

| Pin | X19 |
|-----|------------|
| 1 | L+ / 5 VDC |
| 2 | M / 5 VDC |
| 3 | DI e.0 |
| 4 | DI e.1 |
| 5 | DQ e.0 |
| 6 | DQ e.1 |

A.11.4 SB 1223 2 X 24 VDC input / 2 X 24 VDC output specifications

Table A- 201 General specifications

| Technical Data | SB 1223 DI 2 x 24 VDC, DQ 2 x 24 VDC |
|------------------------------|--------------------------------------|
| Order number | 6ES7 223-0BD30-0XB0 |
| Dimensions W x H x D (mm) | 38 x 62 x 21 |
| Weight | 40 grams |
| Power dissipation | 1.0 W |
| Current consumption (SM Bus) | 50 mA |
| Current consumption (24 VDC) | 4 mA / Input used |

Table A- 202 Digital inputs

| Technical Data | SB 1223 DI 2 x 24 VDC, DQ 2 x 24 VDC |
|------------------------------------|--|
| Number of inputs | 2 |
| Type | IEC Type 1 sink |
| Rated voltage | 24 VDC at 4 mA, nominal |
| Continuous permissible voltage | 30 VDC, max. |
| Surge voltage | 35 VDC for 0.5 sec. |
| Logic 1 signal (min.) | 15 VDC at 2.5 mA |
| Logic 0 signal (max.) | 5 VDC at 1 mA |
| HSC clock input rates (max.) | Single phase: 30 kHz (15 to 26 VDC) Quadrature phase: 20 kHz (15 to 26 VDC) |
| Isolation (field side to logic) | 500 VAC for 1 minute |
| Isolation groups | 1 |
| Filter times | us settings 0.1, 0.2, 0.4, 0.8, 1.6, 3.2, 6.4, 10.0, 12.8, 20.0 ms settings 0.05, 0.1, 0.2, 0.4, 0.8, 1.6, 3.2, 6.4, 10.0, 12.8, 20.0 |
| Number of inputs on simultaneously | 2 |
| Cable length (meters) | 500 shielded, 300 unshielded |

Technical specifications

A.11 Digital signal boards (SBs)

Table A- 203 Digital outputs

| Technical Data | SB 1223 DI 2 x 24 VDC, DQ 2 x 24 VDC |
|---------------------------------------|---|
| Number of outputs | 2 |
| Output type | Solid state - MOSFET (sourcing) |
| Voltage range | 20.4 to 28.8 VDC |
| Logic 1 signal at max. current | 20 VDC min. |
| Logic 0 signal with 10K Ω load | 0.1 VDC max. |
| Current (max.) | 0.5 A |
| Lamp load | 5 W |
| On state contact resistance | 0.6 Ω max. |
| Leakage current per point | 10 μ A max. |
| Pulse Train Output (PTO) rate | 20 KHz max., 2 Hz min. ¹ |
| Surge current | 5 A for 100 ms max. |
| Overload protection | No |
| Isolation (field side to logic) | 500 VAC for 1 minute |
| Isolation groups | 1 |
| Currents per common | 1 A |
| Inductive clamp voltage | L+ minus 48 V, 1 W dissipation |
| Switching delay | 2 μ s max. off to on 10 μ s max. on to off |
| Behavior on RUN to STOP | Last value or substitute value (default value 0) |
| Number of outputs on simultaneously | 2 |
| Cable length (meters) | 500 m shielded, 150 m unshielded |

¹ Depending on your pulse receiver and cable, an additional load resistor (at least 10% of rated current) may improve pulse signal quality and noise immunity.

Table A- 204 Wiring diagram for the digital input/output SB

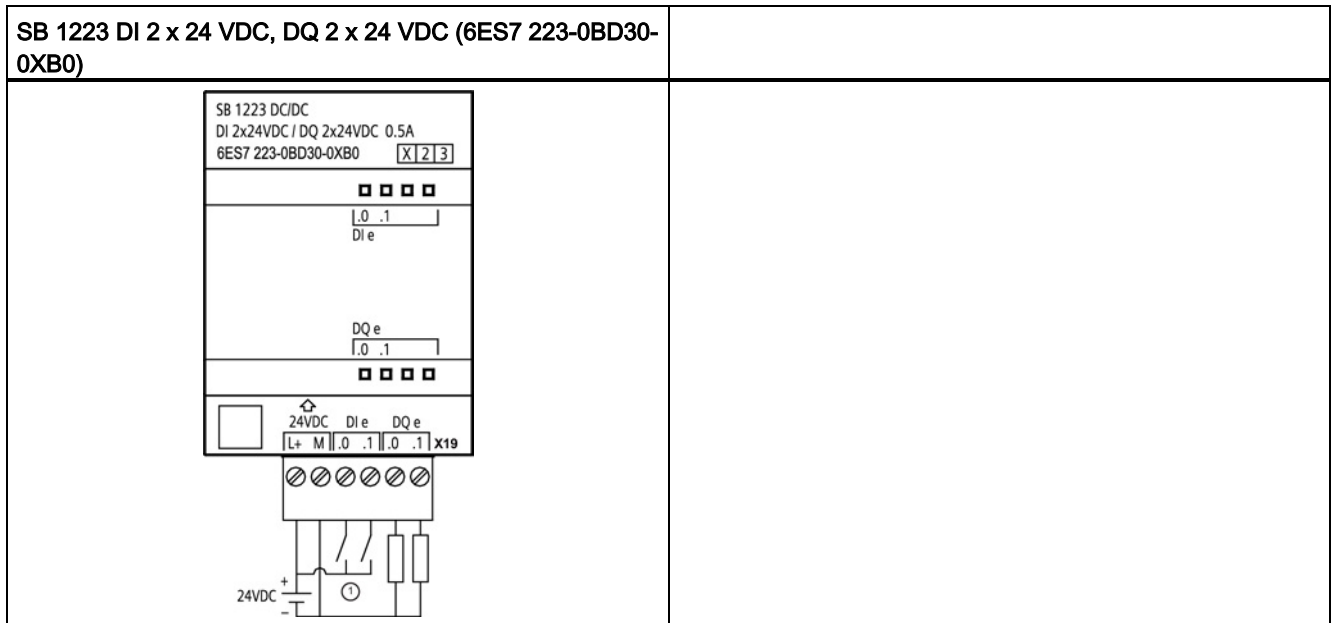

① Supports sinking inputs only

Table A- 205 Connector pin locations for SB 1223 DI 2 x 24 VDC, DQ 2 x 24 VDC (6ES7 223-0BD30-0XB0)

| Pin | X19 |
|-----|-------------|
| 1 | L+ / 24 VDC |
| 2 | M / 24 VDC |
| 3 | DI e.0 |
| 4 | DI e.1 |
| 5 | DQ e.0 |
| 6 | DQ e.1 |

A.12 Analog signal boards (SBs)

A.12.1 SB 1231 1 analog input specifications

Note

To use this SB, your CPU firmware must be V2.0 or higher.

Table A- 206 General specifications

| Technical data | SB 1231 AI 1 x 12 bit |
|------------------------------|-----------------------|
| Order number | 6ES7 231-4HA30-0XB0 |
| Dimensions W x H x D (mm) | 38 x 62 x 21 |
| Weight | 35 grams |
| Power dissipation | 0.4 W |
| Current consumption (SM Bus) | 55 mA |
| Current consumption (24 VDC) | none |

Table A- 207 Analog inputs

| Technical data | SB 1231 AI 1x12 bit |
|-------------------------------------|--|
| Number of inputs | 1 |
| Type | Voltage or current (differential) |
| Range | ±10 V, ±5 V, ±2.5 or 0 to 20 mA |
| Resolution | 11 bits + sign bit |
| Full scale range (data word) | -27648 to 27648 |
| Over/Under range (data word) | Voltage: 32511 to 27649 / -27649 to -32512 Current: 32511 to 27649 / 0 to -4864 (Refer to Analog input representation for voltage and Analog input representation for current.) |
| Overflow/Underflow (data word) | Voltage: 32767 to 32512 / -32513 to -32768 Current: 32767 to 32512 / -4865 to -32768 (Refer to Analog input representation for voltage and Analog input representation for current.) |
| Maximum withstand voltage / current | ±35 V / ±40 mA |
| Smoothing | None, weak, medium, or strong (refer to Analog input response times for step response time.) |
| Noise rejection | 400, 60, 50, or 10 Hz (refer to Analog input response times for sample rates.) |
| Accuracy (25 °C / -20 to 60 °C) | ±0.3% / ±0.6% of full scale |

| Technical data | SB 1231 AI 1x12 bit |
|---------------------------------|--|
| Input impedance | |
| Differential | Voltage: 220 k Ω ; Current: 250 Ω |
| Common mode | Voltage: 55 k Ω ; Current: 55 k Ω |
| Behavior on RUN to STOP | Last value or substitute value (default value 0) |
| Measuring principle | Actual value conversion |
| Common mode rejection | 400 dB, DC to 60 Hz |
| Operational signal range | Signal plus common mode voltage must be less than +35 V and greater than -35 V |
| Isolation (field side to logic) | None |
| Cable length (meters) | 100 m, twisted and shielded |

Table A- 208 Diagnostics

| Technical data | SB 1231 AI 1 x 12 bit |
|--------------------|-----------------------|
| Overflow/underflow | Yes |
| 24 VDC low voltage | no |

Table A- 209 Wiring diagram for the analog input SB

| SB 1231 AI x 12 bit (6ES7 231-4HA30-0XB0) | |
|--|--|
| <p style="font-size: small; margin-top: 10px;">SB 1231 AI AI 1 x 12 BIT +/- 10VDC / 0-20mA 6ES7 231-4HA30-0XB0</p> | |
| <p>① Connect "R" and "0+" for current</p> | |
| <p>Note: Connectors must be gold. See Appendix C, Spare Parts for order number.</p> | |

A.12 Analog signal boards (SBs)

Table A- 210 Connector pin locations for SB 1231 AI x 12 bit (6ES7 231-4HA30-0XB0)

| Pin | X19 (gold) |
|-----|---------------|
| 1 | No connection |
| 2 | No connection |
| 3 | AI R |
| 4 | AI 0+ |
| 5 | AI 0+ |
| 6 | AI 0- |

A.12.2 SB 1232 1 analog output specifications

Table A- 211 General specifications

| Technical data | SB 1232 AQ 1 x 12 bit |
|------------------------------|-----------------------|
| Order number | 6ES7 232-4HA30-0XB0 |
| Dimensions W x H x D (mm) | 38 x 62 x 21 |
| Weight | 40 grams |
| Power dissipation | 1.5 W |
| Current consumption (SM Bus) | 15 mA |
| Current consumption (24 VDC) | 40 mA (no load) |

Table A- 212 Analog outputs

| Technical data | SB 1232 AQ 1 x 12 bit |
|--|--|
| Number of outputs | 1 |
| Type | Voltage or current |
| Range | ±10 V or 0 to 20 mA |
| Resolution | Voltage: 12 bits Current: 11 bits |
| Full scale range (data word) | Voltage: -27648 to 27648 |
| Refer to the output ranges for voltage and current (Page 951). | Current: 0 to 27648 |
| Accuracy (25 °C / -20 to 60 °C) | ±0.5% / ±1% of full scale |
| Settling time (95% of new value) | Voltage: 300 µS (R), 750 µS (1 uF) Current: 600 µS (1 mH), 2 ms (10 mH) |
| Load impedance | Voltage: ≥ 1000 Ω Current: ≤ 600 Ω |
| Behavior on RUN to STOP | Last value or substitute value (default value 0) |
| Isolation (field side to logic) | None |
| Cable length (meters) | 100 m, twisted and shielded |

Table A- 213 Diagnostics

| Technical data | SB 1232 AQ 1 x 12 bit |
|-------------------------------------|-----------------------|
| Overflow/underflow | Yes |
| Short to ground (voltage mode only) | Yes |
| Wire break (current mode only) | Yes |

Table A- 214 Wiring diagram for the SB 1232 AQ 1 x 12 bit

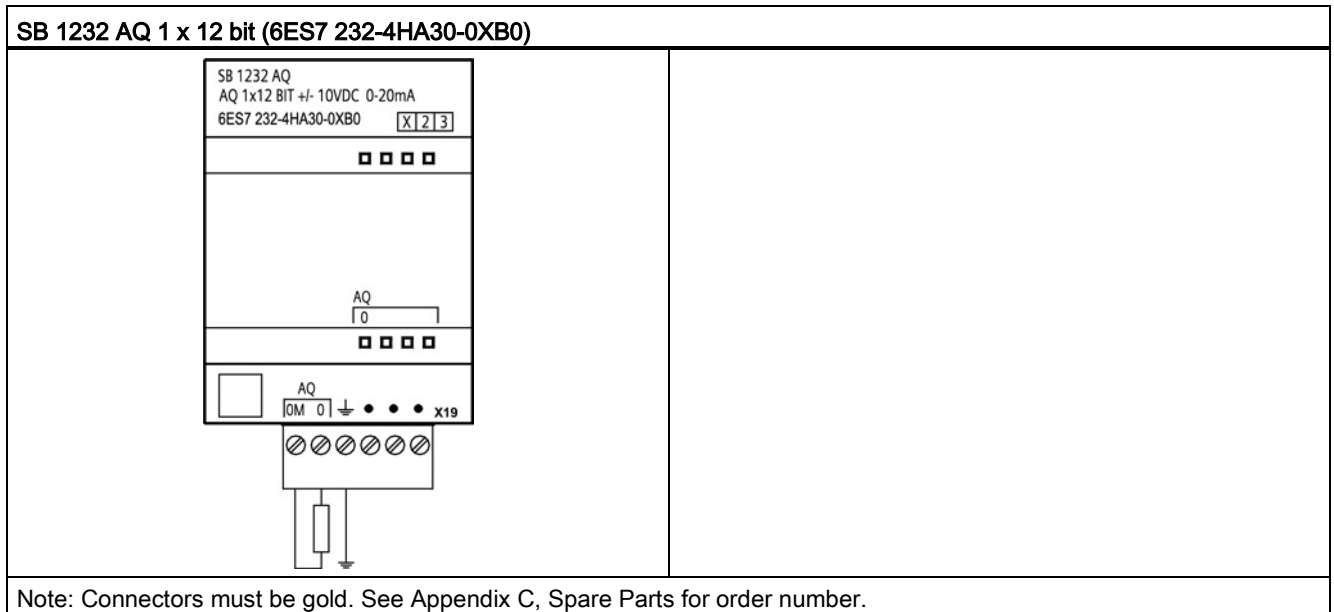

Table A- 215 Connector pin locations for SB 1232 AQ 1 x 12 bit (6ES7 232-4HA30-0XB0)

| Pin | X19 (gold) |
|-----|---------------|
| 1 | AQ 0M |
| 2 | AQ 0 |
| 3 | GND |
| 4 | No connection |
| 5 | No connection |
| 6 | No connection |

A.12.3 Measurement ranges for analog inputs and outputs

A.12.3.1 Step response of the analog inputs

Table A- 216 Step response (ms), 0 V to 10 V measured at 95%

| Smoothing selection (sample averaging) | Integration time selection | | | |
|--|----------------------------|-----------------|-----------------|-----------------|
| | 400 Hz (2.5 ms) | 60 Hz (16.6 ms) | 50 Hz (20 ms) | 10 Hz (100 ms) |
| None (1 cycle): No averaging | 4.5 ms | 18.7 ms | 22.0 ms | 102 ms |
| Weak (4 cycles): 4 samples | 10.6 ms | 59.3 ms | 70.8 ms | 346 ms |
| Medium (16 cycles): 16 samples | 33.0 ms | 208 ms | 250 ms | 1240 ms |
| Strong (32 cycles): 32 samples | 63.0 ms | 408 ms | 490 ms | 2440 ms |
| Sample time | 0.156 ms | 1.042 ms | 1.250 ms | 6.250 ms |

A.12.3.2 Sample time and update times for the analog inputs

Table A- 217 Sample time and update time

| Selection | Sample time | SB update time |
|-----------------|-------------|----------------|
| 400 Hz (2.5 ms) | 0.156 ms | 0.156 ms |
| 60 Hz (16.6 ms) | 1.042 ms | 1.042 ms |
| 50 Hz (20 ms) | 1.250 ms | 1.25 ms |
| 10 Hz (100 ms) | 6.250 ms | 6.25 ms |

A.12.3.3 Measurement ranges of the analog inputs for voltage and current (SB and SM)

Table A- 218 Analog input representation for voltage (SB and SM)

| System | | Voltage Measuring Range | | | | |
|---------|-------------|-------------------------|----------|----------|----------|-----------------|
| Decimal | Hexadecimal | ±10 V | ±5 V | ±2.5 V | ±1.25 V | |
| 32767 | 7FFF | 11.851 V | 5.926 V | 2.963 V | 1.481 V | Overflow |
| 32512 | 7F00 | | | | | |
| 32511 | 7EFF | 11.759 V | 5.879 V | 2.940 V | 1.470 V | Overshoot range |
| 27649 | 6C01 | | | | | |
| 27648 | 6C00 | 10 V | 5 V | 2.5 V | 1.250 V | Rated range |
| 20736 | 5100 | 7.5 V | 3.75 V | 1.875 V | 0.938 V | |
| 1 | 1 | 361.7 µV | 180.8 µV | 90.4 µV | 45.2 µV | |
| 0 | 0 | 0 V | 0 V | 0 V | 0 V | |
| -1 | FFFF | | | | | |
| -20736 | AF00 | -7.5 V | -3.75 V | -1.875 V | -0.938 V | |
| -27648 | 9400 | -10 V | -5 V | -2.5 V | -1.250 V | |

| System | | Voltage Measuring Range | | | | |
|---------|-------------|-------------------------|----------|----------|----------|------------------|
| Decimal | Hexadecimal | ±10 V | ±5 V | ±2.5 V | ±1.25 V | |
| -27649 | 93FF | | | | | Undershoot range |
| -32512 | 8100 | -11.759 V | -5.879 V | -2.940 V | -1.470 V | |
| -32513 | 80FF | | | | | Underflow |
| -32768 | 8000 | -11.851 V | -5.926 V | -2.963 V | -1.481 V | |

Table A- 219 Analog input representation for current (SB and SM)

| System | | Current measuring range | | |
|---------|-------------|-------------------------|-----------------|-----------------|
| Decimal | Hexadecimal | 0 mA to 20 mA | 4 mA to 20 mA | |
| 32767 | 7FFF | 23.70 mA | 22.96 mA | Overflow |
| 32512 | 7F00 | | | |
| 32511 | 7EFF | 23.52 mA | 22.81 mA | Overshoot range |
| 27649 | 6C01 | | | |
| 27648 | 6C00 | 20 mA | 20 mA | Nominal range |
| 20736 | 5100 | 15 mA | 16 mA | |
| 1 | 1 | 723.4 nA | 4 mA + 578.7 nA | |
| 0 | 0 | 0 mA | 4 mA | |
| -1 | FFFF | | | |
| -4864 | ED00 | -3.52 mA | 1.185 mA | Underflow |
| -4865 | ECFF | | | |
| -32768 | 8000 | | | |

A.12.3.4 Measurement ranges of the analog outputs for voltage and current (SB and SM)

Table A- 220 Analog output representation for voltage (SB and SM)

| System | | Voltage Output Range | |
|---------|-------------|----------------------|-----------------|
| Decimal | Hexadecimal | ± 10 V | |
| 32767 | 7FFF | See note 1 | Overflow |
| 32512 | 7F00 | See note 1 | |
| 32511 | 7EFF | 11.76 V | Overshoot range |
| 27649 | 6C01 | | |
| 27648 | 6C00 | 10 V | Rated range |
| 20736 | 5100 | 7.5 V | |
| 1 | 1 | 361.7 μ V | |
| 0 | 0 | 0 V | |
| -1 | FFFF | -361.7 μ V | |
| -20736 | AF00 | -7.5 V | |
| -27648 | 9400 | -10 V | |

A.12 Analog signal boards (SBs)

| System | | Voltage Output Range | |
|---------|-------------|----------------------|------------------|
| Decimal | Hexadecimal | ± 10 V | |
| -27649 | 93FF | | Undershoot range |
| -32512 | 8100 | -11.76 V | |
| -32513 | 80FF | See note 1 | Underflow |
| -32768 | 8000 | See note 1 | |

¹ In an overflow or underflow condition, analog outputs will take on the substitute value of the STOP mode.

Table A- 221 Analog output representation for current (SB and SM)

| System | | Current output range | | |
|---------|-------------|----------------------|------------------|---|
| Decimal | Hexadecimal | 0 mA to 20 mA | 4 mA to 20 mA | |
| 32767 | 7FFF | See note 1 | See note 1 | Overflow |
| 32512 | 7F00 | See note 1 | See note 1 | |
| 32511 | 7EFF | 23.52 mA | 22.81 mA | Overshoot range |
| 27649 | 6C01 | | | |
| 27648 | 6C00 | 20 mA | 20 mA | Rated range |
| 20736 | 5100 | 15 mA | 16 mA | |
| 1 | 1 | 723.4 nA | 4 mA + 578.7 nA | |
| 0 | 0 | 0 mA | 4mA | |
| -1 | FFFF | | 4 mA to 578.7 nA | Undershoot range |
| -6912 | E500 | | 0 mA | |
| -6913 | E4FF | | | Not possible. Output value limited to 0 mA. |
| -32512 | 8100 | | | |
| -32513 | 80FF | See note 1 | See note 1 | Underflow |
| -32768 | 8000 | See note 1 | See note 1 | |

¹ In an overflow or underflow condition, analog outputs will take on the substitute value of the STOP mode.

A.12.4 Thermocouple signal boards (SBs)

A.12.4.1 SB 1231 1 analog thermocouple input specifications

Note

To use this SB, your CPU firmware must be V2.0 or higher.

Table A- 222 General specifications

| Technical data | SB 1231 AI 1 x 16 bit Thermocouple |
|------------------------------|------------------------------------|
| Order number | 6ES7 231-5QA30-0XB0 |
| Dimensions W x H x D (mm) | 38 x 62 x 21 |
| Weight | 35 grams |
| Power dissipation | 0.5 W |
| Current consumption (SM Bus) | 5 mA |
| Current consumption (24 VDC) | 20 mA |

Table A- 223 Analog inputs

| Technical data | SB 1231 AI 1x16 bit Thermocouple |
|---|--|
| Number of inputs | 1 |
| Type | Floating TC and mV |
| Range | See Thermocouple filter selection table (Page 954). |
| <ul style="list-style-type: none"> • Nominal range (data word) • Overrange/underrange (data word) • Overflow/underflow (data word) | |
| Resolution | 0.1° C / 0.1° F |
| | Voltage |
| | 15 bits plus sign |
| Maximum withstand voltage | ±35 V |
| Noise rejection | 85 dB for the selected filter setting (10 Hz, 50 Hz, 60 Hz, 400 Hz) |
| Common mode rejection | > 120 dB at 120 VAC |
| Impedance | ≥ 10 M Ω |
| Accuracy | See Thermocouple selection table (Page 954). |
| Repeatability | ±0.05% FS |
| Measuring principle | Integrating |
| Module update time | See Thermocouple filter selection table (Page 954). |
| Cold junction error | ±1.5° C |
| Isolation (field side to logic) | 500 VAC |

A.12 Analog signal boards (SBs)

| Technical data | SB 1231 AI 1x16 bit Thermocouple |
|-----------------------|----------------------------------|
| Cable length (meters) | 100 m to sensor max. |
| Wire resistance | 100 Ω max. |

Table A- 224 Diagnostics

| Technical data | SB 1231 AI 1 x 16 bit Thermocouple |
|---------------------------------|------------------------------------|
| Overflow/underflow ¹ | Yes |
| Wire break ² | Yes |

¹ The overflow and underflow diagnostic alarm information will be reported in the analog data values even if the alarms are disabled in the module configuration.

² When wire break alarm is disabled and an open wire condition exists in the sensor wiring, the module may report random values.

The SM 1231 Thermocouple (TC) analog signal module measures the value of voltage connected to the module inputs.

The SB 1231 Thermocouple analog signal board measures the value of voltage connected to the signal board inputs. The temperature measurement type can be either "Thermocouple" or "Voltage".

- "Thermocouple": The value will be reported in degrees multiplied by ten (for example, 25.3 degrees will be reported as decimal 253).
- "Voltage": The nominal range full scale value will be decimal 27648.

A.12.4.2 Basic operation for a thermocouple

Thermocouples are formed whenever two dissimilar metals are electrically bonded to each other. A voltage is generated that is proportional to the junction temperature. This voltage is small; one microvolt could represent many degrees. Measuring the voltage from a thermocouple, compensating for extra junctions, and then linearizing the result forms the basis of temperature measurement using thermocouples.

When you connect a thermocouple to the SM 1231 Thermocouple module, the two dissimilar metal wires are attached to the module at the module signal connector. The place where the two dissimilar wires are attached to each other forms the sensor thermocouple.

Two more thermocouples are formed where the two dissimilar wires are attached to the signal connector. The connector temperature causes a voltage that adds to the voltage from the sensor thermocouple. If this voltage is not corrected, then the temperature reported will deviate from the sensor temperature.

Cold junction compensation is used to compensate for the connector thermocouple. Thermocouple tables are based on a reference junction temperature, usually zero degrees Celsius. The cold junction compensation compensates the connector to zero degrees Celsius. The cold junction compensation restores the voltage added by the connector thermocouples. The temperature of the module is measured internally, and then converted to a value to be added to the sensor conversion. The corrected sensor conversion is then linearized using the thermocouple tables.

For optimum operation of the cold junction compensation, the thermocouple module must be located in a thermally stable environment. Slow variation (less than 0.1 °C/minute) in ambient module temperature is correctly compensated within the module specifications. Air movement across the module will also cause cold junction compensation errors.

If better cold junction error compensation is needed, an external iso-thermal terminal block may be used. The thermocouple module provides for use of a 0 °C referenced or 50 °C referenced terminal block.

Selection table for the SB 1231 thermocouple

The ranges and accuracy for the different thermocouple types supported by the SB 1231 Thermocouple signal board are shown in the table below.

Table A- 225 SB 1231 Thermocouple selection table

| Thermocouple Type | Under range minimum ¹ | Nominal range low limit | Nominal range high limit | Over range maximum ² | Normal range ³ accuracy @ 25 °C | Normal range ³ accuracy -20 °C to 60 °C |
|-------------------|----------------------------------|-------------------------|--------------------------|---------------------------------|--|--|
| J | -210.0 °C | -150.0 °C | 1200.0 °C | 1450.0 °C | ±0.3 °C | ±0.6 °C |
| K | -270.0 °C | -200.0 °C | 1372.0 °C | 1622.0 °C | ±0.4 °C | ±1.0 °C |
| T | -270.0 °C | -200.0 °C | 400.0 °C | 540.0 °C | ±0.5 °C | ±1.0 °C |
| E | -270.0 °C | -200.0 °C | 1000.0 °C | 1200.0 °C | ±0.3 °C | ±0.6 °C |
| R & S | -50.0 °C | 100.0 °C | 1768.0 °C | 2019.0 °C | ±1.0 °C | ±2.5 °C |
| B | 0.0 °C | 200.0 °C | 800.0 °C | -- | ±2.0 °C | ±2.5 °C |
| | -- | 800.0 °C | 1820.0 °C | 1820.0 °C | ±1.0 °C | ±2.3 °C |
| N | -270.0 °C | 0.0 °C | 1300.0 °C | 1550.0 °C | ±1.0 °C | ±1.6 °C |
| C | 0.0 °C | 100.0 °C | 2315.0 °C | 2500.0 °C | ±0.7 °C | ±2.7 °C |
| TXK/XK(L) | -200.0 °C | -150.0 °C | 800.0 °C | 1050.0 °C | ±0.6 °C | ±1.2 °C |
| Voltage | -32511 | -27648 -80mV | 27648 80mV | 32511 | ±0.05% | ±0.1% |

¹ Thermocouple values below the under-range minimum value are reported as -32768.

² Thermocouple values above the over-range minimum value are reported as 32767.

³ Internal cold junction error is ±1.5 °C for all ranges. This adds to the error in this table. The signal board requires at least 30 minutes of warm-up time to meet this specification.

Table A- 226 Filter selection table for the SB 1231 Thermocouple

| Rejection frequency (Hz) | Integration time (ms) | Signal board update time (seconds) |
|--------------------------|-----------------------|------------------------------------|
| 10 | 100 | 0.306 |
| 50 | 20 | 0.066 |
| 60 | 16.67 | 0.056 |
| 400 ¹ | 10 | 0.036 |

¹ To maintain module resolution and accuracy when 400 Hz rejection is selected, the integration time is 10 ms. This selection also rejects 100 Hz and 200 Hz noise.

A.12 Analog signal boards (SBs)

It is recommended for measuring thermocouples that a 100 ms integration time be used. The use of smaller integration times will increase the repeatability error of the temperature readings.

Note

After power is applied to the module, it performs internal calibration for the analog to digital converter. During this time, the module reports a value of 32767 on each channel until valid data is available on that channel. Your user program may need to allow for this initialization time.

Table A- 227 Wiring diagram for SB 1231 AI 1 x 16 thermocouple

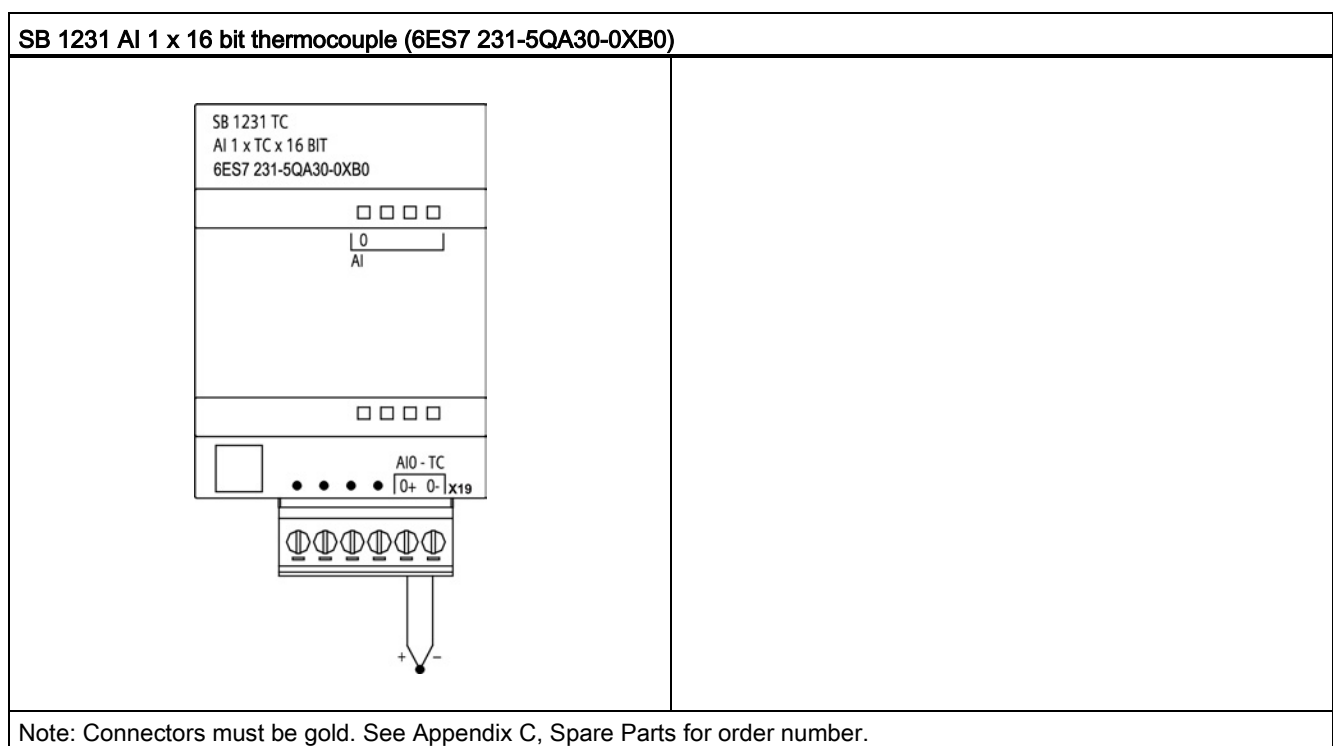

Table A- 228 Connector pin locations for SB 1231 AI 1 x 16 bit thermocouple (6ES7 231-5QA30-0XB0)

| Pin | X19 (gold) |
|-----|---------------|
| 1 | No connection |
| 2 | No connection |
| 3 | No connection |
| 4 | No connection |
| 5 | AI 0- /TC |
| 6 | AI 0+ /TC |

A.12.5 RTD signal boards (SBs)

A.12.5.1 SB 1231 1 analog RTD input specifications

Note

To use this SB, your CPU firmware must be V2.0 or higher.

Table A- 229 General specifications

| Technical data | SB 1231 AI 1 x 16 bit RTD |
|------------------------------|---------------------------|
| Order number | 6ES7 231-5PA30-0XB0 |
| Dimensions W x H x D (mm) | 38 x 62 x 2 |
| Weight | 35 grams |
| Power dissipation | 0.7 W |
| Current consumption (SM Bus) | 5 mA |
| Current consumption (24 VDC) | 25 mA |

Table A- 230 Analog inputs

| Technical data | SB 1231 AI 1 x 16 bit RTD | | | | |
|---|---|-------------|----------------|---------|-------------------|
| Number of inputs | 1 | | | | |
| Type | Module referenced RTD and Ohms | | | | |
| Range | See Selection tables (Page 960). | | | | |
| <ul style="list-style-type: none"> • Nominal range (data word) • Overrange/underrange (data word) • Overflow/underflow (data word) | | | | | |
| Resolution | <table border="0" style="width: 100%;"> <tr> <td style="width: 50%; text-align: center;">Temperature</td> <td>0.1 °C/ 0.1 °F</td> </tr> <tr> <td style="width: 50%; text-align: center;">Voltage</td> <td>15 bits plus sign</td> </tr> </table> | Temperature | 0.1 °C/ 0.1 °F | Voltage | 15 bits plus sign |
| Temperature | 0.1 °C/ 0.1 °F | | | | |
| Voltage | 15 bits plus sign | | | | |
| Maximum withstand voltage | ±35 V | | | | |
| Noise rejection | 85 dB (10 Hz, 50 Hz, 60 Hz, 400 Hz) | | | | |
| Common mode rejection | > 120 dB | | | | |
| Impedance | ≥ 10 MΩ | | | | |
| Accuracy | See Selection tables (Page 960). | | | | |
| Repeatability | ±0.05% FS | | | | |
| Maximum sensor dissipation | 0.5 m W | | | | |
| Measuring principle | Integrating | | | | |
| Module update time | See Selection table (Page 960). | | | | |
| Isolation (field side to logic) | 500 VAC | | | | |

Technical specifications

A.12 Analog signal boards (SBs)

| Technical data | SB 1231 AI 1 x 16 bit RTD |
|-----------------------|-----------------------------|
| Cable length (meters) | 100 m to sensor max. |
| Wire resistance | 20 Ω, 2.7 for 10 Ω RTD max. |

Table A- 231 Diagnostics

| Technical data | SB 1231 AI 1 x 16 bit RTD |
|------------------------------------|---------------------------|
| Overflow/underflow ^{1, 2} | Yes |
| Wire break ³ | Yes |

- ¹ The overflow and underflow diagnostic alarm information will be reported in the analog data values even if the alarms are disabled in the module configuration.
- ² For resistance ranges underflow detection is never enabled.
- ³ When wire break alarm is disabled and an open wire condition exists in the sensor wiring, the module may report random values.

The SM 1231 RTD analog signal board measures the value of resistance connected to the signal board inputs. The measurement type can be selected as either "Resistor" or "Thermal resistor".

- "Resistor": The nominal range full scale value will be decimal 27648.
- "Thermal resistor": The value will be reported in degrees multiplied by ten (for example, 25.3 degrees will be reported as decimal 253). The climatic range values will be reported in degrees multiplied by one hundred (for example, 25.34 degrees will be reported as decimal 2534).

The SB 1231 RTD signal board supports measurements with 2-wire, 3-wire and 4-wire connections to the sensor resistor.

Table A- 232 Wiring diagram for SB 1231 AI 1 x 16 bit RTD

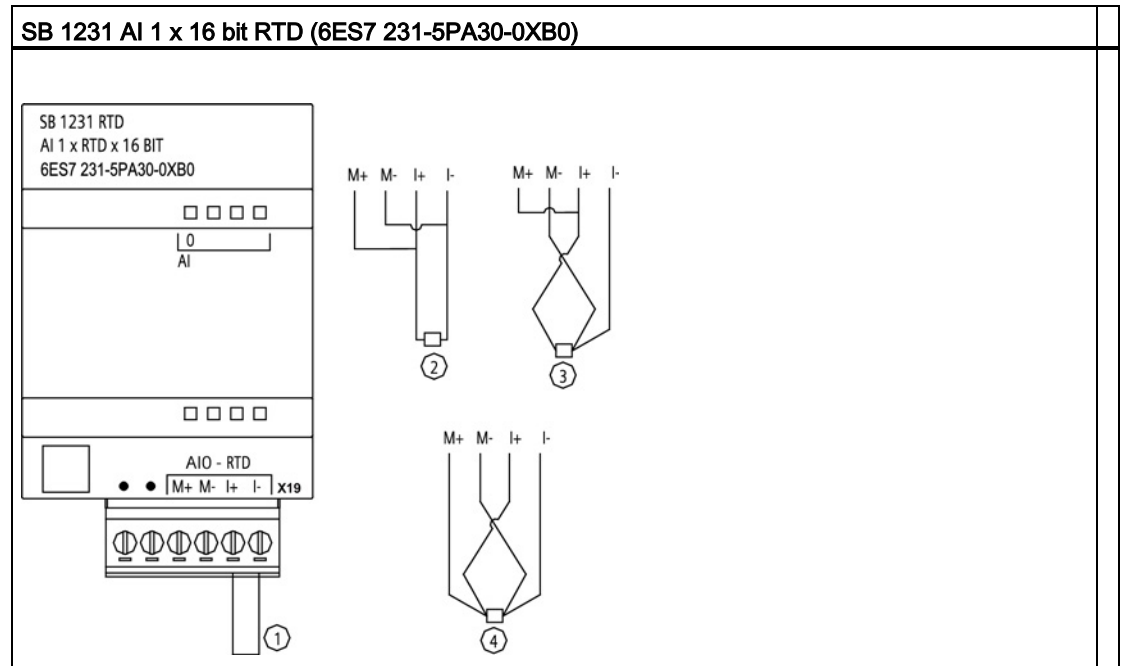

- ① Loop-back unused RTD input
- ② 2-wire RTD
- ③ 3-wire RTD
- ④ 4-wire RTD

Note: Connectors must be gold. See Appendix C, Spare Parts for order number.

Table A- 233 Connector pin locations for SB 1231 AI 1 x 16 bit RTD (6ES7 231-5PA30-0XB0)

| Pin | X19 (gold) |
|-----|---------------|
| 1 | No connection |
| 2 | No connection |
| 3 | AI 0 M+ /RTD |
| 4 | AI 0 M- /RTD |
| 5 | AI 0 I+ /RTD |
| 6 | AI 0 I- /RTD |

A.12.5.2 Selection tables for the SB 1231 RTD

Table A- 234 Ranges and accuracy for the different sensors supported by the RTD modules

| Temperature coefficient | RTD type | Under range minimum ¹ | Nominal range low limit | Nominal range high limit | Over range maximum ² | Normal range accuracy @ 25 °C | Normal range accuracy -20 °C to 60 °C |
|---|-----------------|----------------------------------|-------------------------|--------------------------|---------------------------------|-------------------------------|---------------------------------------|
| Pt 0.003850 ITS90 DIN EN 60751 | Pt 100 climatic | -145.00 °C | -120.00 °C | -145.00 °C | -155.00 °C | ±0.20 °C | ±0.40 °C |
| | Pt 10 | -243.0 °C | -200.0 °C | 850.0 °C | 1000.0 °C | ±1.0 °C | ±2.0 °C |
| | Pt 50 | -243.0 °C | -200.0 °C | 850.0 °C | 1000.0 °C | ±0.5 °C | ±1.0 °C |
| | Pt 100 | | | | | | |
| | Pt 200 | | | | | | |
| | Pt 500 | | | | | | |
| | Pt 1000 | | | | | | |
| Pt 0.003902 Pt 0.003916 Pt 0.003920 | Pt 100 | -243.0 °C | -200.0 °C | 850.0 °C | 1000.0 °C | ± 0.5 °C | ±1.0 °C |
| | Pt 200 | | | | | | |
| | Pt 500 | | | | | | |
| | Pt 1000 | | | | | | |
| Pt 0.003910 | Pt 10 | -273.2 °C | -240.0 °C | 1100.0 °C | 1295 °C | ±1.0 °C | ±2.0 °C |
| | Pt 50 | -273.2 °C | -240.0 °C | 1100.0 °C | 1295 °C | ±0.8 °C | ±1.6 °C |
| | Pt 100 | -273.2 °C | -240.0 °C | 1100.0 °C | 1295 °C | ±0.8 °C | ±1.6 °C |
| | Pt 500 | | | | | | |
| Ni 0.006720 Ni 0.006180 | Ni 100 | -105.0 °C | -60.0 °C | 250.0 °C | 295.0 °C | ±0.5 °C | ±1.0 °C |
| | Ni 120 | | | | | | |
| | Ni 200 | | | | | | |
| | Ni 500 | | | | | | |
| | Ni 1000 | | | | | | |
| LG-Ni 0.005000 | LG-Ni 1000 | -105.0 °C | -60.0 °C | 250.0 °C | 295.0 °C | ±0.5 °C | ±1.0 °C |
| Ni 0.006170 | Ni 100 | -105.0 °C | -60.0 °C | 180.0 °C | 212.4 °C | ±0.5 °C | ±1.0 °C |
| Cu 0.004270 | Cu 10 | -240.0 °C | -200.0 °C | 260.0 °C | 312.0 °C | ±1.0 ° | ±2.0 °C |
| Cu 0.004260 | Cu 10 | -60.0 °C | -50.0 °C | 200.0 °C | 240.0 °C | ±1.0 °C | ±2.0 °C |
| | Cu 50 | -60.0 °C | -50.0 °C | 200.0 °C | 240.0 °C | ±0.6 °C | ±1.2 °C |
| | Cu 100 | | | | | | |
| Cu 0.004280 | Cu 10 | -240.0 °C | -200.0 °C | 200.0 °C | 240.0 °C | ±1.0 °C | ±2.0 °C |
| | Cu 50 | -240.0 °C | -200.0 °C | 200.0 °C | 240.0 °C | ±0.7 °C | ±1.4 °C |
| | Cu 100 | | | | | | |

¹ RTD values below the under-range minimum value are reported as -32768.

² RTD values above the over-range maximum value are reported as +32768.

Table A- 235 Resistance

| Range | Under range minimum | Nominal range low limit | Nominal range high limit | Over range maximum ¹ | Normal range accuracy @ 25 °C | Normal range accuracy -20 °C to 60 °C |
|-------|---------------------|-------------------------|--------------------------|---------------------------------|-------------------------------|---------------------------------------|
| 150 Ω | n/a | 0 (0 Ω) | 27648 (150 Ω) | 176.383 Ω | ±0.05% | ±0.1% |
| 300 Ω | n/a | 0 (0 Ω) | 27648 (300 Ω) | 352.767 Ω | ±0.05% | ±0.1% |
| 600 Ω | n/a | 0 (0 Ω) | 27648 (600 Ω) | 705.534 Ω | ±0.05% | ±0.1% |

¹ Resistance values above the over-range maximum value are reported as 32767.

Note

The module reports 32767 on any activated channel with no sensor connected. If open wire detection is also enabled, the module flashes the appropriate red LEDs.

Best accuracy will be achieved for the 10 Ω RTD ranges if 4 wire connections are used.

The resistance of the connection wires in 2 wire mode will cause an error in the sensor reading and therefore accuracy is not guaranteed.

Table A- 236 Noise reduction and update times for the RTD modules

| Rejection frequency selection | Integration time | 4-/2-wire, 1-channel module Update time (seconds) | 3-wire, 1-channel module Update time (seconds) |
|-------------------------------|--------------------|--|---|
| 400 Hz (2.5 ms) | 10 ms ¹ | 0.036 | 0.071 |
| 60 Hz (16.6 ms) | 16.67 ms | 0.056 | 0.111 |
| 50 Hz (20 ms) | 20 ms | 0.066 | 1.086 |
| 10 Hz (100 ms) | 100 ms | 0.306 | 0.611 |

¹ To maintain module resolution and accuracy when the 400 Hz filter is selected, the integration time is 10 ms. This selection also rejects 100 Hz and 200 Hz noise.

Note

After power is applied, the module performs internal calibration for the analog-to-digital converter. During this time the module reports a value of 32767 on each channel until valid data is available on that channel. Your user program may need to allow for this initialization time. Because the configuration of the module can vary the length of the initialization time, you should verify the behavior of the module in your configuration. If required, you can include logic in your user program to accommodate the initialization time of the module.

A.13 BB 1297 Battery board

BB 1297 Battery Board

The S7-1200 BB 1297 Battery Board is designed for long-term backup of the Real-time clock. It is pluggable in the signal board slot of the S7-1200 CPU (firmware 3.0 and later versions). You must add the BB 1297 to the device configuration and download the hardware configuration to the CPU for the BB to be functional.

The battery (type CR1025) is not included with the BB 1297 and must be purchased by the user.

Note

The BB 1297 is mechanically designed to fit the CPUs with the firmware 3.0 and later versions.

Do not use the BB 1297 with earlier version CPUs as the BB 1297 connector will not plug into the CPU.

Table A- 237 General specifications

| Technical data | BB 1297 Battery Board |
|------------------------------|-----------------------|
| Order number | 6ES7 297-0AX30-0XA0 |
| Dimensions W x H x D (mm) | 38 x 62 x 21 |
| Weight | 28 grams |
| Power dissipation | 0.5 W |
| Current consumption (SM Bus) | 11 mA |
| Current consumption (24 VDC) | none |

| Battery (not included) | BB 1297 Battery Board |
|------------------------|--|
| Hold up time | Approximately 1 year |
| Battery type | CR1025 Refer to Installing or replacing a battery in the BB 1297 battery board (Page 58) |
| Nominal voltage | 3 V |
| Nominal capacity | At least 30 mAH |

| Diagnostics | BB 1297 Battery Board |
|------------------------|---|
| Critical battery level | < 2.5 V |
| Battery diagnostic | Low voltage indicator: <ul style="list-style-type: none"> • Low battery voltage causes the CPU MAINT LED to illuminate with the amber light continuously ON. • Diagnostic Buffer Event: 16#06:2700 "Submodule maintenance demanded: At least one battery exhausted (BATTF)" |
| Battery status | Battery status bit provided 0 = Battery OK 1 = Battery low |
| Battery status update | Battery status is updated at power up and then once per day while CPU is in RUN mode. |

Table A- 238 Insertion diagram for the BB 1297 battery board

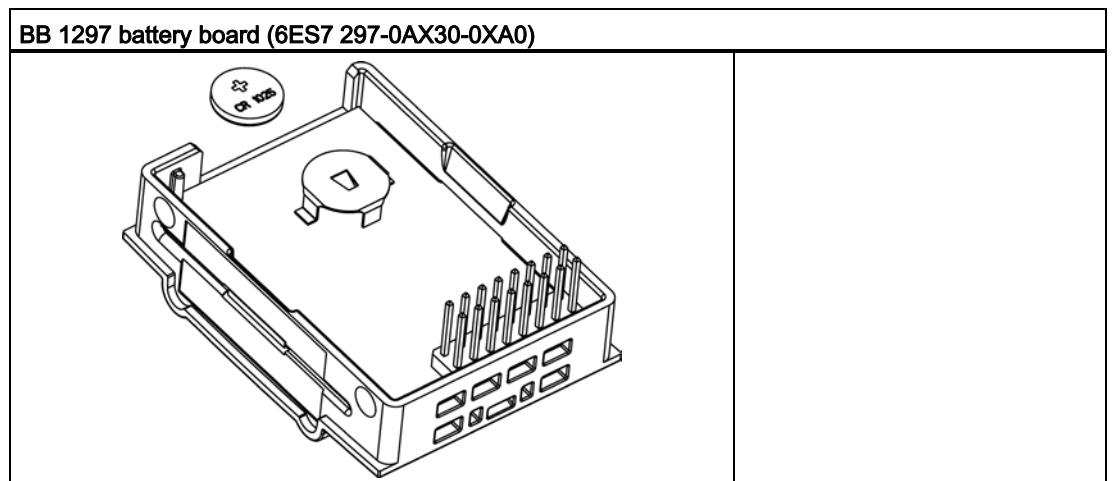

A.14 Communication interfaces

A.14.1 PROFIBUS

A.14.1.1 CM 1242-5 PROFIBUS DP Slave

Table A- 239 Technical specifications of the CM 1242-5

| Technical specifications | |
|---|--|
| Order number | 6GK7 242-5DX30-0XE0 |
| Interfaces | |
| Connection to PROFIBUS | 9-pin D-sub female connector |
| Maximum current consumption on the PROFIBUS interface when connecting network components (for example optical network components) | 15 mA at 5 V (only for bus termination) *) |
| Permitted ambient conditions | |
| Ambient temperature | |
| <ul style="list-style-type: none"> • during storage • during transportation • during operation with a vertical installation (DIN rail horizontal) • during operation with a horizontal installation (DIN rail vertical) | <ul style="list-style-type: none"> • -40 °C to 70 °C • -40 °C to 70 °C • 0 °C to 55 °C • 0 °C to 45 °C |
| Relative humidity at 25 °C during operation, without condensation, maximum | 95 % |
| Degree of protection | IP20 |
| Power supply, current consumption and power loss | |
| Type of power supply | DC |
| Power supply from the backplane bus | 5 V |
| Current consumption (typical) | 150 mA |
| Effective power loss (typical) | 0.75 W |
| Electrical isolation | 710 VDC for 1 minute |
| <ul style="list-style-type: none"> • PROFIBUS interface to ground • PROFIBUS interface to internal circuit | |
| Dimensions and weights | |
| <ul style="list-style-type: none"> • Width • Height • Depth | <ul style="list-style-type: none"> • 30 mm • 100 mm • 75 mm |

Technical specifications

Weight

- | | |
|------------------------------|---------|
| • Net weight | • 115 g |
| • Weight including packaging | • 152 g |

*)The current load of an external consumer connected between VP (pin 6) and DGND (pin 5) must not exceed a maximum of 15 mA (short-circuit proof) for bus termination.

PROFIBUS interface

Table A- 240 Pinout of the D-sub socket

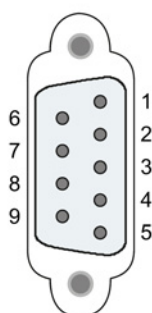

| Pin | Description | Pin | Description |
|-----|--|---------|------------------------|
| 1 | - not used - | 6 | P5V2: +5V power supply |
| 2 | - not used - | 7 | - not used - |
| 3 | RxD/TxD-P: Data line B | 8 | RxD/TxD-N: Data line A |
| 4 | RTS | 9 | - not used - |
| 5 | M5V2: Data reference potential (ground DGND) | Housing | Ground connector |

A.14.1.2 CM 1243-5 PROFIBUS DP Master

Table A- 241 Technical specifications of the CM 1243-5

| Technical specifications | |
|---|--|
| Order number | 6GK7 243-5DX30-0XE0 |
| Interfaces | |
| Connection to PROFIBUS | 9-pin D-sub female connector |
| Maximum current consumption on the PROFIBUS interface when connecting network components (for example optical network components) | 15 mA at 5 V (only for bus termination) *) |
| Permitted ambient conditions | |
| Ambient temperature | |
| • during storage | • -40 °C to 70 °C |
| • during transportation | • -40 °C to 70 °C |
| • during operation with a vertical installation (DIN rail horizontal) | • 0 °C to 55 °C |
| • during operation with a horizontal installation (DIN rail vertical) | • 0 °C to 45 °C |
| Relative humidity at 25 °C during operation, without condensation, maximum | 95 % |
| Degree of protection | IP20 |
| Power supply, current consumption and power loss | |
| Type of power supply | DC |

Technical specifications

A.14 Communication interfaces

Technical specifications

| | |
|--|--|
| Power supply / external | 24 V |
| <ul style="list-style-type: none"> • minimum • maximum | <ul style="list-style-type: none"> • 19.2 V • 28.8 V |
| Current consumption (typical) | |
| <ul style="list-style-type: none"> • from 24 V DC • from the S7-1200 backplane bus | <ul style="list-style-type: none"> • 100 mA • 0 mA |
| Effective power loss (typical) | |
| <ul style="list-style-type: none"> • from 24 V DC • from the S7-1200 backplane bus | <ul style="list-style-type: none"> • 2.4 W • 0 W |
| Power supply 24 VDC / external | |
| <ul style="list-style-type: none"> • Min. cable cross section • Max. cable cross section • Tightening torque of the screw terminals | <ul style="list-style-type: none"> • min.: 0.14 mm² (AWG 25) • max.: 1.5 mm² (AWG 15) • 0.45 Nm (4 lb-in) |
| Electrical isolation | 710 VDC for 1 minute |
| <ul style="list-style-type: none"> • PROFIBUS interface to ground • PROFIBUS interface to internal circuit | |
| Dimensions and weights | |
| <ul style="list-style-type: none"> • Width • Height • Depth | <ul style="list-style-type: none"> • 30 mm • 100 mm • 75 mm |
| Weight | |
| <ul style="list-style-type: none"> • Net weight • Weight including packaging | <ul style="list-style-type: none"> • 134 g • 171 g |

*)The current load of an external consumer connected between VP (pin 6) and DGND (pin 5) must not exceed a maximum of 15 mA (short-circuit proof) for bus termination.

Note

The CM 1243-5 (PROFIBUS master module) must receive power from the 24 VDC sensor supply of the CPU.

PROFIBUS interface

Table A- 242 Pinout of the D-sub socket

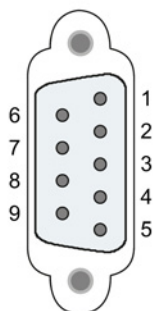

| Pin | Description | Pin | Description |
|-----|--------------|-----|--|
| 1 | - not used - | 6 | VP: Power supply +5 V only for bus terminating resistors; not for supplying external devices |
| 2 | - not used - | 7 | - not used - |

| Pin | Description | Pin | Description |
|-----|--------------------------------------|---------|------------------------|
| 3 | RxD/TxD-P: Data line B | 8 | RxD/TxD-N: Data line A |
| 4 | CNTR-P: RTS | 9 | - not used - |
| 5 | DGND: Ground for data signals and VP | Housing | Ground connector |

PROFIBUS cable

Note

Contacting the shield of the PROFIBUS cable

The shield of the PROFIBUS cable must be contacted.

To do this, strip the insulation from the end of the PROFIBUS cable and connect the shield to functional earth.

A.14.2 GPRS

Note

The GPRS CP is not approved for Maritime applications

The following module does not have Maritime approval:

- CP 1242-7 GPRS module

Note

To use these modules, your CPU firmware must be V2.0 or higher.

A.14.2.1 CP 1242-7 GPRS

Table A- 243 Technical specifications of the CP 1242-7

| Technical specifications | |
|---------------------------------|---------------------|
| Order number | 6GK7 242-7KX30-0XE0 |
| Wireless interface | |
| Antenna connector | SMA socket |
| Nominal impedance | 50 ohms |
| Wireless connection | |

Technical specifications

A.14 Communication interfaces

Technical specifications

| | |
|------------------------|---|
| Maximum transmit power | <ul style="list-style-type: none">• GSM 850, class 4: +33 dBm ±2dBm• GSM 900, class 4: +33 dBm ±2dBm• GSM 1800, class 1: +30 dBm ±2dBm• GSM 1900, class 1: +30 dBm ±2dBm |
|------------------------|---|

| | |
|------|--|
| GPRS | Multislot class 10 device class B coding scheme 1...4 (GMSK) |
|------|--|

| | |
|-----|--|
| SMS | Mode outgoing: MO service: point-to-point |
|-----|--|

Permitted ambient conditions

| | |
|--|---|
| Ambient temperature | |
| <ul style="list-style-type: none">• during storage• during transportation• during operation with a vertical installation (DIN rail horizontal)• during operation with a horizontal installation (DIN rail vertical) | <ul style="list-style-type: none">• -40 °C to 70 °C• -40 °C to 70 °C• 0 °C to 55 °C• 0 °C to 45 °C |

| | |
|--|------|
| Relative humidity at 25 °C during operation, without condensation, maximum | 95 % |
|--|------|

| | |
|----------------------|------|
| Degree of protection | IP20 |
|----------------------|------|

Power supply, current consumption and power loss

| | |
|----------------------|----|
| Type of power supply | DC |
|----------------------|----|

| | |
|---|---|
| Power supply / external | 24 V |
| <ul style="list-style-type: none">• minimum• maximum | <ul style="list-style-type: none">• 19.2 V• 28.8 V |

| | |
|---|---|
| Current consumption (typical) | |
| <ul style="list-style-type: none">• from 24 V DC• from the S7-1200 backplane bus | <ul style="list-style-type: none">• 100 mA• 0 mA |

| | |
|---|---|
| Effective power loss (typical) | |
| <ul style="list-style-type: none">• from 24 V DC• from the S7-1200 backplane bus | <ul style="list-style-type: none">• 2.4 W• 0 W |

| | |
|--|--|
| 24 V DC power supply | |
| <ul style="list-style-type: none">• Min. cable cross section• Max. cable cross section• Tightening torque of the screw terminals | <ul style="list-style-type: none">• min.: 0.14 mm² (AWG 25)• max.: 1.5 mm² (AWG 15)• 0.45 Nm (4 lb-in) |

| | |
|----------------------|----------------------|
| Electrical isolation | 710 VDC for 1 minute |
|----------------------|----------------------|

| | |
|---------------------------------------|--|
| Power supply unit to internal circuit | |
|---------------------------------------|--|

Dimensions and weights

Technical specifications

- | | |
|--|--|
| <ul style="list-style-type: none"> • Width • Height • Depth | <ul style="list-style-type: none"> • 30 mm • 100 mm • 75 mm |
|--|--|
-

Weight

- | | |
|--|--|
| <ul style="list-style-type: none"> • Net weight • Weight including packaging | <ul style="list-style-type: none"> • 133 g • 170 g |
|--|--|
-

Technical specifications of the ANT794-4MR GSM/GPRS antenna

| ANT794-4MR | |
|------------------------------|--|
| Order number | 6NH9860-1AA00 |
| Mobile wireless networks | GSM/GPRS |
| Frequency ranges | <ul style="list-style-type: none"> • 824 to 960 MHz (GSM 850, 900) • 1 710 to 1 880 MHz (GSM 1 800) • 1 900 to 2 200 MHz (GSM / UMTS) |
| Characteristics | omnidirectional |
| Antenna gain | 0 dB |
| Impedance | 50 ohms |
| Standing wave ratio (SWR) | < 2,0 |
| Max. power | 20 W |
| Polarity | linear vertical |
| Connector | SMA |
| Length of antenna cable | 5 m |
| External material | Hard PVC, UV-resistant |
| Degree of protection | IP20 |
| Permitted ambient conditions | <ul style="list-style-type: none"> • Operating temperature • Transport/storage temperature • Relative humidity |
| | <ul style="list-style-type: none"> • -40 °C through +70 °C • -40 °C through +70 °C • 100 % |
| External material | Hard PVC, UV-resistant |
| Construction | Antenna with 5 m fixed cable and SMA male connector |
| Dimensions (D x H) in mm | 25 x 193 |
| Weight | <ul style="list-style-type: none"> • Antenna incl. cable • Fittings |
| | <ul style="list-style-type: none"> • 310 g • 54 g |
| Installation | With supplied bracket |

Technical specifications of the flat antenna ANT794-3M

| | | |
|------------------------------|---|----------------------|
| Order number | 6NH9870-1AA00 | |
| Mobile wireless networks | GSM 900 | GSM 1800/1900 |
| Frequency ranges | 890 - 960 MHz | 1710 - 1990 MHz |
| Standing wave ratio (VSWR) | ≤ 2:1 | ≤ 1,5:1 |
| Return loss (Tx) | ≈ 10 dB | ≈ 14 dB |
| Antenna gain | 0 dB | |
| Impedance | 50 ohms | |
| Max. power | 10 W | |
| Antenna cable | HF cable RG 174 (fixed) with SMA male connector | |
| Cable length | 1.2 m | |
| Degree of protection | IP64 | |
| Permitted temperature range | -40°C to +75°C | |
| Flammability | UL 94 V2 | |
| External material | ABS Polylac PA-765, light gray (RAL 7035) | |
| Dimensions (W x L x H) in mm | 70.5 x 146.5 x 20.5 | |
| Weight | 130 g | |

A.14.3 CM 1243-2 AS-i master

A.14.3.1 Technical data for the AS-i master CM 1243-2

Table A- 244 Technical data for the AS-i master CM 1243-2

| Technical data | |
|---|--|
| Order number | 3RK7243-2AA30-0XB0 |
| Firmware version | V1.0 |
| Date | 01.12.2011 |
| Interfaces | |
| Maximum current consumption | |
| From the S7-1200 backplane bus | Max. 250 mA, supply voltage S7-1200 communication bus 5 V DC |
| From the AS-i cable | Max. 100 mA |
| Maximum current carrying capacity between the ASI+/ASI- terminals | 8 A |
| Pin assignment | See section Electrical connections of the AS-i master CM 1243-2 (Page 971) |
| Conductor cross-section | 0.2 mm ² (AWG 24) ... 3.3 mm ² (AWG 12) |
| ASI connector tightening torque | 0.56 Nm |
| Permissible ambient conditions | |

| Technical data | |
|---|------------------|
| Ambient temperature | |
| During storage | -40 °C ... 70 °C |
| During transport | -40 °C ... 70 °C |
| During the operating phase, with vertical installation (horizontal standard mounting rail) | 0 °C ... 55 °C |
| During the operating phase, with horizontal installation (vertical standard mounting rail) | 0 °C ... 45 °C |
| Relative humidity at 25 °C during operating phase, no condensation, maximum | 95 % |
| Degree of protection | IP20 |
| Power supply, current consumption, power loss | |
| Type of power supply | DC |
| Current consumption (typically) | |
| From the S7-1200 backplane bus | 200 mA |
| Total power loss (typical): | |
| • From the S7-1200 backplane bus | 1 W |
| • From AS-i cable | 2.4 W |
| Dimensions and weights | |
| Width | 30 mm |
| Height | 100 mm |
| Depth | 75 mm |
| Weight | |
| Net weight | 122 g |
| Weight including packaging | 159 g |

A.14.3.2 Electrical connections of the AS-i master CM 1243-2

Power supply of the AS-i master CM 1243-2

The AS-i master CM 1243-2 is supplied over the communications bus of the S7-1200. This means that a diagnostics message can still be sent to the S7-1200 following failure of the AS-i supply voltage. The connection to the communications bus is on the right-hand side of the AS-i master CM 1243-2.

AS-Interface terminals

The removable terminal for connecting the AS-i cable is located behind the lower cover on the front of the AS-i master CM 1243-2.

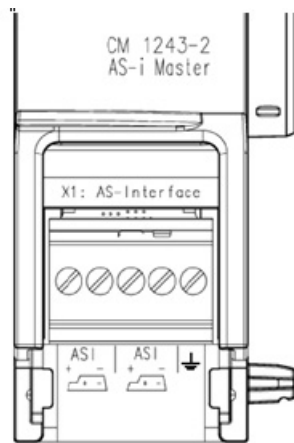

If the AS-i shaped cable is used, you can recognize the correct polarity of the cable by means of the symbol .

Information on how to remove and re-install the terminal block can be found in the system manual "SIMATIC S7-1200 Programmable Controller" (Order No.: 6ES7298-8FA30-8AH0).

Note

Maximum current carrying capacity of the terminal contacts

The current carrying capacity of the connection contacts is max. 8 A. If this value is exceeded on the AS-i cable, the AS-i master CM 1243-2 must not be "looped in" to the AS-i cable, but must instead be connected via a spur line (only one connection pair assigned on the AS-i master CM 1243-2).

Please also ensure that the cables used are suitable for operating temperatures of at least 75°C if current is being conducted via the AS-i master and currents of greater than 4 amperes are present.

You will find additional information on connecting the AS-i cable in the section "Installation, connection and commissioning of the modules" in the manual "AS-i Master CM 1243-2 and AS-i data decoupling unit DCM 1271 for SIMATIC S7-1200".

Terminal assignment

| Label | Meaning |
|---|-------------------------------------|
| ASI+ | AS-i connection – positive polarity |
| ASI- | AS-i connection – negative polarity |
|  | Functional ground |

A.14.4 RS232, RS422, and RS485

A.14.4.1 CB 1241 RS485 specifications

Note

To use this CB, your CPU firmware must be V2.0 or higher.

Table A- 245 General specifications

| Technical data | CB 1241 RS485 |
|---------------------------|----------------------|
| Order number | 6ES7 241-1CH30-1XB0 |
| Dimensions W x H x D (mm) | 38 x 62 x 21 |
| Weight | 40 grams |

Table A- 246 Transmitter and receiver

| Technical data | CB 1241 RS485 |
|---|--|
| Type | RS485 (2-wire half-duplex) |
| Common mode voltage range | -7 V to +12 V, 1 second, 3 VRMS continuous |
| Transmitter differential output voltage | 2 V min. at $R_L = 100 \Omega$ 1.5 V min. at $R_L = 54 \Omega$ |
| Termination and bias | 10K to +5 V on B, RS485 Pin 3 10K to GND on A, RS485 Pin 4 |
| Optional termination | Short Pin TB to Pin T/RB, effective termination impedance is 127 Ω , connects to RS485 Pin 3 Short Pin TA to Pin T/RA, effective termination impedance is 127 Ω , connects to RS485 Pin 4 |
| Receiver input impedance | 5.4K Ω min. including termination |
| Receiver threshold/sensitivity | +/- 0.2 V min., 60 mV typical hysteresis |
| Isolation RS485 signal to chassis ground RS485 signal to CPU logic common | 500 VAC, 1 minute |
| Cable length, shielded | 1000 m max. |
| Baud rate | 300 baud, 600 baud, 1.2 kbits, 2.4 kbits, 4.8 kbits, 9.6 kbits (default), 19.2 kbits, 38.4 kbits, 57.6 kbits, 76.8 kbits, 115.2 kbits, |
| Parity | No parity (default), even, odd, Mark (parity bit always set to 1), Space (parity bit always set to 0) |
| Number of stop bits | 1 (default), 2 |
| Flow control | Not supported |
| Wait time | 0 to 65535 ms |

A.14 Communication interfaces

Table A- 247 Power supply

| Technical data | CB 1241 RS485 |
|------------------------------------|---------------|
| Power loss (dissipation) | 1.5 W |
| Current consumption (SM Bus), max. | 50 mA |
| Current consumption (24 VDC) max. | 80 mA |

| | |
|---|--|
| <p>CB 1241 RS485 (6ES7 241-1CH30-1XB0)</p> | |
| <p>① Connect "TA" and TB" as shown to terminate the network. (Terminate only the end devices on the RS485 network.)</p> | |
| <p>② Use shielded twisted pair cable and connect the cable shield to ground.</p> | |

You terminate only the two ends of the RS485 network. The devices in between the two end devices are not terminated or biased. See the S7-1200 System Manual section on "Biasing and terminating an RS485 network connector"

Table A- 248 Connector pin locations for CB 1241 RS485 (6ES7 241-1CH30-1XB0)

| Pin | 9-Pin connector | X20 |
|-----|-------------------|----------|
| 1 | RS485 / Logic GND | -- |
| 2 | RS485 / Not Used | -- |
| 3 | RS485 / TxD+ | 3 - T/RB |
| 4 | RS485 / RTS | 1 - RTS |
| 5 | RS485 / Logic GND | -- |
| 6 | RS485 / 5 V Power | -- |
| 7 | RS485 / Not used | -- |
| 8 | RS485 / TxD- | 4 - T/RA |

| Pin | 9-Pin connector | X20 |
|-------|------------------|-------|
| 9 | RS485 / Not Used | -- |
| Shell | | 7 - M |

See also

Biasing and terminating an RS485 network connector (Page 670)

A.14.4.2 CM 1241 RS232 specifications

Table A- 249 General specifications

| Technical data | CM 1241 RS232 |
|-----------------|---------------------|
| Order number | 6ES7 241-1AH32-0XB0 |
| Dimensions (mm) | 30 x 100 x 75 |
| Weight | 150 grams |

Table A- 250 Transmitter and receiver

| Technical data | CM 1241 RS232 |
|---|---|
| Type | RS232 (full-duplex) |
| Transmitter output voltage | +/- 5 V min. at $R_L = 3K \Omega$ |
| Transmit output voltage | +/- 15 VDC max. |
| Receiver input impedance | 3 K Ω min. |
| Receiver threshold/sensitivity | 0.8 V min. low, 2.4 max. high 0.5 V typical hysteresis |
| Receiver input voltage | +/- 30 VDC max. |
| Isolation RS 232 signal to chassis ground RS 232 signal to CPU logic common | 500 VAC, 1 minute |
| Cable length, shielded | 10 m max. |
| Baud rate | 300 baud, 600 baud, 1.2 kbits, 2.4 kbits, 4.8 kbits, 9.6 kbits (default), 19.2 kbits, 38.4 kbits, 57.6 kbits, 76.8 kbits, 115.2 kbits, |
| Parity | No parity (default), even, odd, Mark (parity bit always set to 1), Space (parity bit always set to 0) |
| Number of stop bits | 1 (default), 2 |
| Flow control | Hardware, software |
| Wait time | 0 to 65535 ms |

A.14 Communication interfaces

Table A- 251 Power supply

| Technical data | CM 1241 RS232 |
|--------------------------|---------------|
| Power loss (dissipation) | 1 W |
| From +5 VDC | 200 mA |

Table A- 252 RS232 connector (male)

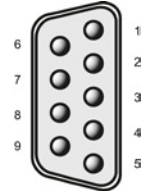
| Pin | Description | Connector (male) | Pin | Description |
|-------|---------------------------------|---|-------|---------------------------|
| 1 DCD | Data carrier detect: Input |  | 6 DSR | Data set ready: Input |
| 2 RxD | Received data from DCE: Input | | 7 RTS | Request to send: Output |
| 3 TxD | Transmitted data to DCE: Output | | 8 CTS | Clear to send: Input |
| 4 DTR | Data terminal ready: Output | | 9 RI | Ring indicator (not used) |
| 5 GND | Logic ground | | SHELL | Chassis ground |

A.14.4.3 CM 1241 RS422/485 specifications

CM 1241 RS422/485 Specifications

Table A- 253 General specifications

| Technical data | CM 1241 RS422/485 |
|---------------------------|---------------------|
| Order number | 6ES7 241-1CH32-0XB0 |
| Dimensions W x H x H (mm) | 30 x 100 x 75 |
| Weight | 155 grams |

Table A- 254 Transmitter and receiver

| Technical data | CM 1241 RS422/485 |
|---|---|
| Type | RS422 or RS485, 9-pin sub D female connector |
| Common mode voltage range | -7 V to +12 V, 1 second, 3 VRMS continuous |
| Transmitter differential output voltage | 2 V min. at $R_L = 100 \Omega$ 1.5 V min. at $R_L = 54 \Omega$ |
| Termination and bias | 10K Ω to +5 V on B, PROFIBUS Pin 3 10K Ω to GND on A, PROFIBUS Pin 8 Internal bias options provided, or no internal bias. In all cases, external termination is required, see Biasing and terminating an RS485 network connector (Page 670) and Configuring the RS422 and RS485 in the S7-1200 System Manual (Page 707) |
| Receiver input impedance | 5.4K Ω min. including termination |
| Receiver threshold/sensitivity | +/- 0.2 V min., 60 mV typical hysteresis |

| Technical data | CM 1241 RS422/485 |
|---|---|
| Isolation RS485 signal to chassis ground RS485 signal to CPU logic common | 500 VAC, 1 minute |
| Cable length, shielded | 1000 m max. (baud rate dependent) |
| Baud rate | 300 baud, 600 baud, 1.2 kbits, 2.4 kbits, 4.8 kbits, 9.6 kbits (default), 19.2 kbits, 38.4 kbits, 57.6 kbits, 76.8 kbits, 115.2 kbits, |
| Parity | No parity (default), even, odd, Mark (parity bit always set to 1), Space (parity bit always set to 0) |
| Number of stop bits | 1 (default), 2 |
| Flow control | XON/XOFF supported for the RS422 mode |
| Wait time | 0 to 65535 ms |

Table A- 255 Power supply

| Technical data | CM 1241 RS422/485 |
|--------------------------|--------------------------|
| Power loss (dissipation) | 1.1 W |
| From +5 VDC | 220 mA |

Table A- 256 RS485 or RS422 connector (female)

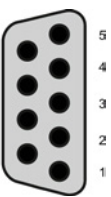
| Pin | Description | Connector (female) | Pin | Description |
|---------------------|---|---|---------------------|---|
| 1 | Logic or communication ground |  | 6 PWR | +5 V with 100 ohm series resistor: Output |
| 2 TxD+ ¹ | Connected for RS422 Not used for RS485: Output | | 7 | Not connected |
| 3 TxD+ | Signal B (Rx/D/TxD+): Input/Output | | 8 TXD- | Signal A (Rx/D/TxD-): Input/Output |
| 4 RTS ² | Request to send (TTL level) Output | | 9 TXD- ¹ | Connected for RS422 Not used for RS485: Output |
| 5 GND | Logic or communication ground | | SHELL | Chassis ground |

¹ Pins 2 and 9 are only used as transmit signals for RS422.

² The RTS is a TTL level signal and can be used to control another half duplex device based on this signal. It is active when you transmit and is inactive all other times.

A.15 TeleService (TS Adapter and TS Adapter modular)

The following manuals contain the technical specification for the TS Adapter IE Basic and the TS Adapter modular:

- Industrial Software Engineering Tools
Modular TS Adapter
- Industrial Software Engineering Tools
TS Adapter IE Basic

For more information about this product and for the product documentation, refer to the product catalog web site for the TS Adapter

(<https://eb.automation.siemens.com/mall/en/de/Catalog/Search?searchTerm=TS%20Adapter%20IE%20basic&tab=>).

A.16 SIMATIC memory cards

| Order Number | Capacity |
|---------------------|----------|
| 6ES7 954-8LT02-0AA0 | 32 GB |
| 6ES7 954-8LP02-0AA0 | 2 GB |
| 6ES7 954-8LL02-0AA0 | 256 MB |
| 6ES7 954-8LF02-0AA0 | 24 MB |
| 6ES7 954-8LE02-0AA0 | 12 MB |
| 6ES7 954-8LC02-0AA0 | 4 MB |

A.17 Input simulators

Table A- 257 General specifications

| Technical data | 8 Position Simulator | 14 Position Simulator | CPU 1217C Simulator |
|---------------------------|----------------------|-----------------------|---------------------|
| Order number | 6ES7 274-1XF30-0XA0 | 6ES7 274-1XH30-0XA0 | 6ES7 274-1XK30-0XA0 |
| Dimensions W x H x D (mm) | 43 x 35 x 23 | 67 x 35 x 23 | 93 x 40 x 23 |
| Weight | 20 grams | 30 grams | 43 grams |
| Points | 8 | 14 | 14 |
| Used with CPU | CPU 1211C, CPU 1212C | CPU 1214C, CPU 1215C | CPU 1217C |

WARNING

Safe use of input simulators

These input simulators are not approved for use in Class I DIV 2 or Class I Zone 2 hazardous locations. The switches present a potential spark hazard/explosion hazard if used in a Class I DIV 2 or Class I Zone 2 location. Unapproved use could result in death or serious injury to personnel, and/or damage to equipment.

Use these input simulators only in non-hazardous locations. Do not use in Class I DIV 2 or Class I Zone 2 hazardous locations.

8 Position Simulator (6ES7 274-1XF30-0XA0)

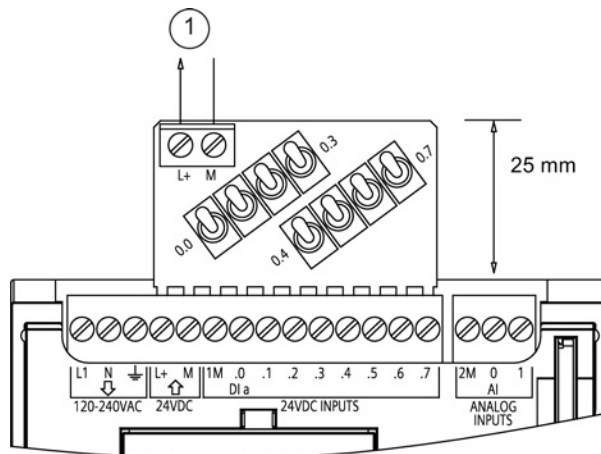

① 24 VDC sensor power out

14 Position Simulator (6ES7 274-1XF30-0XA0)

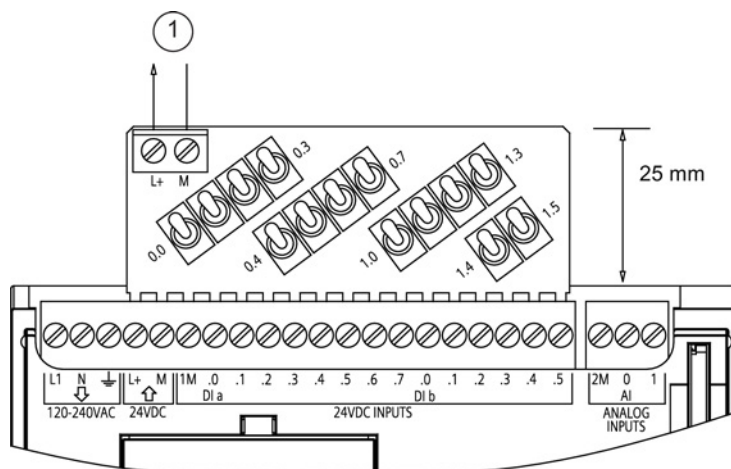

① 24 VDC sensor power out

A.18 S7-1200 Potentiometer module

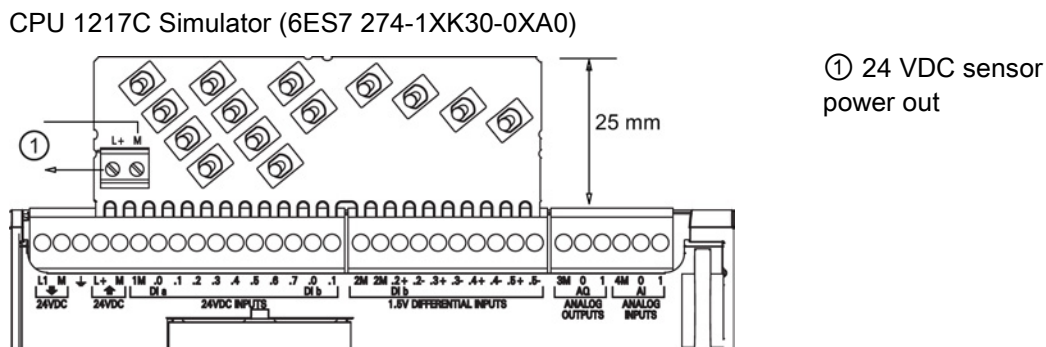

A.18 S7-1200 Potentiometer module

The S7-1200 Potentiometer module is an accessory for S7-1200 CPU. Each potentiometer creates an output voltage proportional to the position of the potentiometer to drive each of the two CPU analog inputs 0 VDC to 10 VDC. To install the potentiometer:

1. Insert the circuit board 'fingers' into any S7-1200 CPU analog input terminal block, and connect an external DC power supply to the 2-position connector on the potentiometer module.
2. Use a small screwdriver to make the adjustments: turn the potentiometer clockwise (to the right) to increase the voltage output, and counterclockwise (to the left) to decrease the voltage output.

Note

Follow ESD guidelines when handling the S7-1200 Potentiometer module.

| Technical data | Description |
|--|------------------------------|
| Order number | 6ES7 274-1XA30-0XA0 |
| Used with CPU | All S7-1200 CPUs |
| Number of potentiometers | 2 |
| Dimensions W x H x D (mm) | 20 x 33 x 14 |
| Weight | 26 grams |
| User-supplied voltage input at 2-position connector ¹ (Class 2, Limited Power, or sensor power from PLC) | 16.4 VDC to 28.8 VDC |
| Cable length (meters)/type | <30 m, shielded twisted pair |
| Input current consumption | 10 mA max. |
| Potentiometer voltage output to S7-1200 CPU analog inputs ¹ | 0 VDC to 10.5 VDC min. |

| Technical data | Description |
|---------------------------|-----------------|
| Isolation | Not isolated |
| Ambient temperature range | -20 °C to 60 °C |

¹ Potentiometer module output voltage stability depends on the quality of the user-supplied voltage input at the 2-position connector - consider it as an analog input voltage.

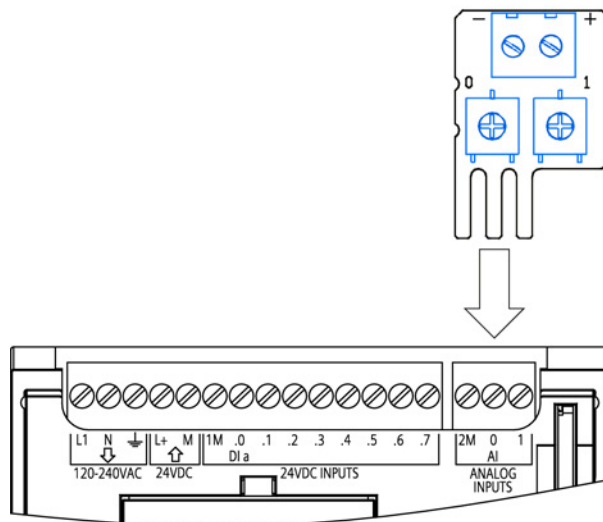

A.19 I/O expansion cable

Table A- 258 Expansion cables

| Technical Data | |
|----------------|---------------------|
| Order number | 6ES7 290-6AA30-0XA0 |
| Cable length | 2 m |
| Weight | 200 g |

Refer to the installation section (Page 64) for information about installing and removing the S7-1200 expansion cable.



A.20 Companion products

A.20.1 PM 1207 power module

The PM 1207 is a power supply module for the SIMATIC S7-1200. It provides the following features:

- Input 120/230 VAC, output 24 VDC/2.5A
- Order number 6ESP 332-1SH71-4AA0

For more information about this product and for the product documentation, refer to the product catalog web site for the PM 1207

(<https://eb.automation.siemens.com/mall/en/de/Catalog/Product/6AG1332-1SH71-4AA0>).

A.20.2 CSM 1277 compact switch module

The CSM1277 is an Industrial Ethernet compact switch module. It can be used to multiply the Ethernet interface of the S7-1200 to allow simultaneous communication with operator panels, programming devices, or other controllers. It provides the following features:

- 4 x RJ45 sockets for connecting to Industrial Ethernet
- 3 pole plug in terminal strip for connection of the external 24 VDC supply on top
- LEDs for diagnostics and status display of Industrial Ethernet ports
- Order number 6GK7 277-1AA00-0AA0

For more information about this product and for the product documentation, refer to the product catalog web site for the CSM 1277

(<https://eb.automation.siemens.com/mall/en/de/Catalog/Search?searchTerm=csm%201277&tab=>).

A.20.3 CM CANopen module

The CM CANopen module is a plug-in module between the SIMATIC S7-1200 PLC and any device running CANopen. The CM CANopen can be configured to be both master or slave. There are two CM CANopen modules: the CANopen module (order number 021620-B), and the CANopen (Ruggedized) module (order number 021730-B).

The CANopen module provides the following features:

- Able to connect 3 modules per CPU
- Connects up to 16 CANopen slave nodes
- 256 byte input and 256 byte output per module
- 3 LEDs provide diagnostic information on module, network, and I/O status
- Supports storage of CANopen network configuration in the PLC
- The module is integratable in the hardware catalogue of the TIA Portal configuration suite
- CANopen configuration via included CANopen Configuration Studio (included) or via any other external CANopen configuration tool
- Complies to the CANopen communication profiles CiA 301 rev. 4.2 and the CiA 302 rev. 4.1
- Supports transparent CAN 2.0A for custom protocol handling
- Pre-made function blocks available for each PLC programming in TIA portal
- CM CANopen modules include; DSUB with screw terminals for subnetwork. CM CANopen configuration studio CD, and USB configuration cable

For more information about this product and for the product documentation, refer to the product catalog web site for the CM CANopen.

Calculating a power budget

The CPU has an internal power supply that provides power for the CPU itself, for any expansion modules, and for other 24 VDC user power requirements.

There are four types of expansion modules:

- Signal modules (SM) are installed on the right-side of the CPU. Each CPU allows a maximum number of signal modules possible without regard to the power budget.
 - CPU 1214C, CPU 1215C and CPU 1217C allows 8 signal modules
 - CPU 1212C allows 2 signal modules
 - CPU 1211C allows no signal modules
- Communication modules (CM) are installed on the left-side of the CPU. A maximum of 3 communication modules is allowed for any CPU without regard to the power budget.
- Signal boards (SB), communications boards (CB), and battery boards (BB) are installed on top of the CPU. A maximum of 1 signal board, communication board, or battery board is allowed for any CPU.

Use the following information as a guide for determining how much power (or current) the CPU can provide for your configuration.

Each CPU supplies both 5 VDC and 24 VDC power:

- The CPU provides 5 VDC power for the expansion modules when an expansion module is connected. If the 5 VDC power requirements for expansion modules exceed the power budget of the CPU, you must remove expansion modules until the requirement is within the power budget.
- Each CPU has a 24 VDC sensor supply that can supply 24 VDC for local input points or for relay coils on the expansion modules. If the power requirement for 24 VDC exceeds the power budget of the CPU, you can add an external 24 VDC power supply to provide 24 VDC to the expansion modules. You must manually connect the 24 VDC supply to the input points or relay coils.

WARNING

Connecting an external 24 VDC power supply in parallel with the DC sensor supply can result in a conflict between the two supplies as each seeks to establish its own preferred output voltage level.

The result of this conflict can be shortened lifetime or immediate failure of one or both power supplies, with consequent unpredictable operation of the PLC system. Unpredictable operation could result in death, severe personal injury and/or property damage.

The DC sensor supply on the CPU and any external power supply should provide power to different points. A single connection of the commons is allowed.

Some of the 24 VDC power input ports in the PLC system are interconnected, with a logic common circuit connecting multiple M terminals. The CPU 24 VDC power supply input, the SM relay coil power input, and a non-isolated analog power supply input are examples of circuits that are interconnected when designated as not isolated in the data sheets. All non-isolated M terminals must connect to the same external reference potential.

 **WARNING**

Connecting non-isolated M terminals to different reference potentials will cause unintended current flows that may cause damage or unpredictable operation in the PLC and connected equipment.

Such damage or unpredictable operation could result in death, severe personal injury and/or property damage.

Always be sure that all non-isolated M terminals in a PLC system are connected to the same reference potential.

Information about the power budgets of the CPUs and the power requirements of the signal modules is provided in the technical specifications (Page 829).

Note

Exceeding the power budget of the CPU may result in not being able to connect the maximum number of modules allowed for your CPU.

Sample power budget

The following example shows a sample calculation of the power requirements for a configuration that includes one CPU 1214C AC/DC/Relay, one SB 1223 2 x 24 VDC Input/ 2 x 24 VDC Output, one CM 1241, three SM 1223 8 DC In/8 Relay Out, and one SM 1221 8 DC In. This example has a total of 48 inputs and 36 outputs.

Note

The CPU has already allocated the power required to drive the internal relay coils. You do not need to include the internal relay coil power requirements in a power budget calculation.

The CPU in this example provides sufficient 5 VDC current for the SMs, but does not provide enough 24 VDC current from the sensor supply for all of the inputs and expansion relay coils. The I/O requires 456 mA and the CPU provides only 400 mA. This installation requires an additional source of at least 56 mA at 24 VDC power to operate all the included 24 VDC inputs and outputs.

Table B- 1 Sample power budget

| CPU power budget | 5 VDC | 24 VDC |
|---|---------------------|------------------------|
| CPU 1214C AC/DC/Relay | 1600 mA | 400 mA |
| <i>Minus</i> | | |
| System requirements | 5 VDC | 24 VDC |
| CPU 1214C, 14 inputs | - | 14 * 4 mA = 56 mA |
| 1 SB 1223 2 x 24 VDC Input/ 2 x 24 VDC Output | 50 mA | 2 * 4 mA = 8 mA |
| 1 CM 1241 RS422/485, 5 V power | 220 mA | |
| 3 SM 1223, 5 V power | 3 * 145 mA = 435 mA | - |
| 1 SM 1221, 5 V power | 1 * 105 mA = 105 mA | - |
| 3 SM 1223, 8 inputs each | - | 3 * 8 * 4 mA = 96 mA |
| 3 SM 1223, 8 relay coils each | - | 3 * 8 * 11 mA = 264 mA |
| 1 SM 1221, 8 inputs each | - | 8 * 4 mA = 32 mA |
| Total requirements | 810 mA | 456 mA |
| <i>Equals</i> | | |
| Current balance | 5 VDC | 24 VDC |
| Current balance total | 790 mA | (56 mA) |

Form for calculating your power budget

Use the following table to determine how much power (or current) the S7-1200 CPU can provide for your configuration. Refer to the technical specifications (Page 829) for the power budgets of your CPU model and the power requirements of your signal modules.

Table B- 2 Calculations for a power budget

| CPU power budget | 5 VDC | 24 VDC |
|----------------------------|--------------|---------------|
| | | |
| <i>Minus</i> | | |
| System requirements | 5 VDC | 24 VDC |
| | | |
| | | |
| | | |
| | | |
| | | |
| | | |
| Total requirements | | |
| <i>Equals</i> | | |
| Current balance | 5 VDC | 24 VDC |
| Current balance total | | |

Order numbers

C.1 CPU modules

Table C- 1 S7-1200 CPUs

| CPU models | | Order Number |
|------------|-----------------------|---------------------|
| CPU 1211C | CPU 1211C DC/DC/DC | 6ES7 211-1AE40-0XB0 |
| | CPU 1211C AC/DC/Relay | 6ES7 211-1BE40-0XB0 |
| | CPU 1211C DC/DC/Relay | 6ES7 211-1HE40-0XB0 |
| CPU 1212C | CPU 1212C DC/DC/DC | 6ES7 212-1AE40-0XB0 |
| | CPU 1212C AC/DC/Relay | 6ES7 212-1BE40-0XB0 |
| | CPU 1212C DC/DC/Relay | 6ES7 212-1HE40-0XB0 |
| CPU 1214C | CPU 1214C DC/DC/DC | 6ES7 214-1AG40-0XB0 |
| | CPU 1214C AC/DC/Relay | 6ES7 214-1BG40-0XB0 |
| | CPU 1214C DC/DC/Relay | 6ES7 214-1HG40-0XB0 |
| CPU 1215C | CPU 1215C DC/DC/DC | 6ES7 215-1AG40-0XB0 |
| | CPU 1215C AC/DC/Relay | 6ES7 215-1BG40-0XB0 |
| | CPU 1215C DC/DC/Relay | 6ES7 215-1HG40-0XB0 |
| CPU 1217C | CPU 1217C DC/DC/DC | 6ES7 217-1AG40-0XB0 |

C.2 Signal modules (SMs), signal boards (SBs), and battery boards (BB)

Table C- 2 Signal modules (SMs)

| Signal modules | | Order Number |
|------------------------|---|---------------------|
| Digital input | SM 1221 8 x 24 VDC Input (Sink/Source) | 6ES7 221-1BF32-0XB0 |
| | SM 1221 16 x 24 VDC Input (Sink/Source) | 6ES7 221-1BH32-0XB0 |
| Digital output | SM 1222 8 x 24 VDC Output (Source) | 6ES7 222-1BF32-0XB0 |
| | SM 1222 16 x 24 VDC Output (Source) | 6ES7 222-1BH32-0XB0 |
| | SM 1222 8 x Relay Output | 6ES7 222-1HF32-0XB0 |
| | SM 1222 8 x Relay Output (Changeover) | 6ES7 222-1XF32-0XB0 |
| | SM 1222 16 x Relay Output | 6ES7 222-1HH32-0XB0 |
| Digital input / output | SM 1223 8 x 24 VDC Input (Sink/Source) / 8 x 24 VDC Output (Source) | 6ES7 223-1BH32-0XB0 |
| | SM 1223 16 x 24 VDC Input (Sink/Source) / 16 x 24 VDC Output (Source) | 6ES7 223-1BL32-0XB0 |
| | SM 1223 8 x 24 VDC Input (Sink/Source) / 8 x Relay Output | 6ES7 223-1PH32-0XB0 |
| | SM 1223 16 x 24 VDC Input (Sink/Source) / 16 x Relay Output | 6ES7 223-1PL32-0XB0 |

Order numbers

C.2 Signal modules (SMs), signal boards (SBs), and battery boards (BB)

| Signal modules | | Order Number |
|-----------------------|---|---------------------|
| | SM 1223 8 x 120/230 VAC Input (Sink/Source) / 8 x Relay Outputs | 6ES7 223-1QH32-0XB0 |
| Analog input | SM 1231 4 x Analog Input | 6ES7 231-4HD32-0XB0 |
| | SM 1231 8 x Analog Input | 6ES7 231-4HF32-0XB0 |
| | SM 1231 4 x Analog Input x 16 bit (high feature) | 6ES7 231-5ND32-0XB0 |
| Analog output | SM 1232 2 x Analog Output | 6ES7 232-4HB32-0XB0 |
| | SM 1232 4 x Analog Output | 6ES7 232-4HD32-0XB0 |
| Analog input / output | SM 1234 4 x Analog Input / 2 x Analog Output | 6ES7 234-4HE32-0XB0 |
| RTD and thermocouple | SM 1231 TC 4 x 16 bit | 6ES7 231-5QD32-0XB0 |
| | SM 1231 TC 8 x 16 bit | 6ES7 231-5QF32-0XB0 |
| | SM 1231 RTD 4 x 16 bit | 6ES7 231-5PD32-0XB0 |
| | SM 1231 RTD 8 x 16 bit | 6ES7 231-5PF32-0XB0 |
| Technology modules | SM 1278 4xIO-Link Master | 6ES7 278-4BD32-0XB0 |

Table C- 3 Signal boards (SB) and battery boards (BBs)

| Signal and battery boards | | Order Number |
|---------------------------|---|---------------------|
| Digital input | SB 1221 200 KHz 4 x 24 VDC Input (Source) | 6ES7 221-3BD30-0XB0 |
| | SB 1221 200 KHz 4 x 5 VDC Input (Source) | 6ES7 221-3AD30-0XB0 |
| Digital output | SB 1222 200 KHz 4 x 24 VDC Output (Sink/Source) | 6ES7 222-1BD30-0XB0 |
| | SB 1222 200 KHz 4 x 5 VDC Output (Sink/Source) | 6ES7 222-1AD30-0XB0 |
| Digital input / output | SB 1223 2 x 24 VDC Input (Sink) / 2 x 24 VDC Output (Source) | 6ES7 223-0BD30-0XB0 |
| | SB 1223 200 KHz 2 x 24 VDC Input (Source) / 2 x 24 VDC Output (Sink/Source) | 6ES7 223-3BD30-0XB0 |
| | SB 1223 200 KHz 2 x 5 VDC Input (Source) / 2 x 5 VDC Output (Sink/Source) | 6ES7 223-3AD30-0XB0 |
| Analog | SB 1232 1 Analog Output | 6ES7 232-4HA30-0XB0 |
| | SB 1231 1 Analog Input | 6ES7 231-4HA30-0XB0 |
| | SB 1231 1 Analog Input Thermocouple | 6ES7 231-5QA30-0XB0 |
| | SB 1231 1 Analog Input RTD | 6ES7 231-5PA30-0XB0 |
| Battery | BB 1297 Battery Board (battery type CR1025 not included) | 6ES7 297-0AX30-0XA0 |

C.3 Communication

Table C- 4 Communication module (CM)

| Communication module (CM) | | | Order Number |
|----------------------------|-------------------|-----------------|---------------------|
| RS232, RS422, and RS485 | CM 1241 RS232 | RS232 | 6ES7 241-1AH32-0XB0 |
| | CM 1241 RS422/485 | RS422/485 | 6ES7 241-1CH32-0XB0 |
| PROFIBUS | CM 1243-5 | PROFIBUS Master | 6GK7 243-5DX30-0XE0 |
| | CM 1242-5 | PROFIBUS Slave | 6GK7 242-5DX30-0XE0 |
| AS-i Master | CM 1243-2 | AS-i Master | 3RK7 243-2AA30-0XB0 |

Table C- 5 Communication board (CB)

| Communication board (CB) | | | Order Number |
|--------------------------|---------------|-------|---------------------|
| RS485 | CB 1241 RS485 | RS485 | 6ES7 241-1CH30-1XB0 |

Table C- 6 Communication Processor (CP)

| Communication processor (CP) | | Order Number |
|------------------------------|------|---------------------|
| CP 1242-7 | GPRS | 6GK7 242-7KX30-0XE0 |

Table C- 7 TeleService

| TS Adapter | Order Number |
|---------------------|---------------------|
| TS Adapter IE Basic | 6ES7 972-0EB00-0XA0 |
| TS Module GSM | 6GK7 972-0MG00-0XA0 |
| TS Module RS232 | 6ES7 972-0MS00-0XA0 |
| TS Module Modem | 6ES7 972-0MM00-0XA0 |
| TS Module ISDN | 6ES7 972-0MD00-0XA0 |

Table C- 8 Accessories

| Accessory | | | Order Number |
|-----------|------------|------------------|----------------|
| Antenna | ANT794-4MR | GSM/GPRS antenna | 6NH9 860-1AA00 |
| | ANT794-3M | Flat antenna | 6NH9 870-1AA00 |

Table C- 9 Connectors

| Type of Connector | | Order Number |
|-------------------|---|---------------------|
| RS485 | 35-degree cable output, screw-terminal connection | 6ES7 972-0BA42-0XA0 |
| | 35-degree cable output, FastConnect connection | 6ES7 972-0BA60-0XA0 |

C.4 Other modules

Table C- 10 Companion products

| Item | | Order Number |
|-----------------|--|---------------------|
| Power supply | PM 1207 power supply | 6EP1 332-1SH71-4AA0 |
| Ethernet switch | CSM 1277 Ethernet switch - 4 ports | 6GK7 277-1AA10-0AA0 |
| CM CANopen | CANopen for SIMATIC S7-1200 | 021620-B |
| | CANopen (Ruggedized) for SIMATIC S7-1200 | 021730-B |

C.5 Memory cards

Table C- 11 Memory cards

| SIMATIC memory cards | Order Number |
|----------------------|---------------------|
| SIMATIC MC 4 MB | 6ES7 954-8LC02-0AA0 |
| SIMATIC MC 12 MB | 6ES7 954-8LE02-0AA0 |
| SIMATIC MC 24 MB | 6ES7 954-8LF02-0AA0 |
| SIMATIC MC 256 MB | 6ES7 954-8LL02-0AA0 |
| SIMATIC MC 2 GB | 6ES7 954-8LP01-0AA0 |
| SIMATIC MC 32 GB | 6ES7 954-8LT02-0AA0 |

C.6 Basic HMI devices

Table C- 12 HMI devices

| HMI Basic Panels | Order Number |
|---------------------------|---------------------|
| KTP400 Basic (Mono, PN) | 6AV6 647-0AA11-3AX0 |
| KTP600 Basic (Mono, PN) | 6AV6 647-0AB11-3AX0 |
| KTP600 Basic (Color, PN) | 6AV6 647-0AD11-3AX0 |
| KTP1000 Basic (Color, PN) | 6AV6 647-0AF11-3AX0 |
| TP1500 Basic (Color, PN) | 6AV6 647-0AG11-3AX0 |

C.7 Spare parts and other hardware

Table C- 13 Expansion cables, simulators, terminal blocks, and end retainers

| Item | | Order Number | |
|-------------------------|---------------------------------------|--|---------------------|
| I/O expansion cable | I/O Expansion cable, 2 m | 6ES7 290-6AA30-0XA0 | |
| I/O simulator | Simulator (1211C/1212C - 8 position) | 6ES7 274-1XF30-0XA0 | |
| | Simulator (1214C/1215C - 14 position) | 6ES7 274-1XH30-0XA0 | |
| | Simulator, CPU 1217C | 6ES7 274-1XK30-0XA0 | |
| Potentiometer module | S7-1200 Potentiometer module | 6ES7 274-1XA30-0XA0 | |
| Spare door kit | CPU 1211C/1212C | 6ES7 291-1AA30-0XA0 | |
| | CPU 1214C | 6ES7 291-1AB30-0XA0 | |
| | CPU 1215C | 6ES7 291-1AC30-0XA0 | |
| | CPU 1217C | 6ES7 291-1AD30-0XA0 | |
| | Signal module, 45 mm | 6ES7 291-1BA30-0XA0 | |
| | Signal module, 70 mm | 6ES7 291-1BB30-0XA0 | |
| | Communication module | 6ES7 291-1CC30-0XA0 | |
| Terminal block | Tin | 7 terminal, 4/pk | 6ES7 292-1AG30-0XA0 |
| | | 8 terminal, 4/pk | 6ES7 292-1AH30-0XA0 |
| | | 10 terminal, 4/pk | 6ES7 292-1AK30-0XA0 |
| | | 11 terminal, 4/pk | 6ES7 292-1AL30-0XA0 |
| | | 12 terminal, 4/pk | 6ES7 292-1AM30-0XA0 |
| | | 14 terminal, 4/pk | 6ES7 292-1AP30-0XA0 |
| | | 16 terminal, 4/pk | 6ES7 292-1AR30-0XA0 |
| | | 18 terminal, 4/pk | 6ES7 292-1AT30-0XA0 |
| | Gold | 20 terminal, 4/pk | 6ES7 292-1AV30-0XA0 |
| | | 3 terminal, 4/pk (for analog CPU) | 6ES7 292-1BC30-0XA0 |
| | | 6 terminal, 4/pk (for analog CPU) | 6ES7 292-1BF30-0XB0 |
| | | 6 terminal, 4/pk (for signal board) | 6ES7 292-1BF30-0XA0 |
| | | 7 terminal, 4/pk (for analog signal module) | 6ES7 292-1BG30-0XA0 |
| | Keyed right | 11 terminal, 4/pk (for analog signal module) | 6ES7 292-1BL30-0XA0 |
| | | Keyed left, 7 contact | 6ES7 292-1AG40-0XA1 |
| | | Keyed right, 7 contact | 6ES7 292-1AG40-0XA0 |
| | | Keyed right, 8 contact | 6ES7 292-1AH40-0XA0 |
| | | Keyed right, 11 contact | 6ES7 292-1AL40-0XA0 |
| | | Keyed right, 12 contact | 6ES7 292-1AM40-0XA0 |
| | | Keyed right, 14 contact | 6ES7 292-1AP40-0XA0 |
| Keyed right, 20 contact | | 6ES7 292-1AV40-0XA0 | |
| End Retainer | | End Retainer Thermoplastic, 10 MM | 8WA1808 |
| | | End Retainer Steel, 10.3 MM | 8WA1805 |

C.8 Programming software

Table C- 14 Programming software

| SIMATIC software | | Order Number |
|------------------------|---|---------------------|
| Programming software | STEP 7 Basic V13 | 6ES7 822-0AA01-0YA0 |
| | STEP 7 Professional V13 | 6ES7 822-1AA01-0YA5 |
| Visualization software | WinCC Basic V12 SP1 | 6AV2100-0AA01-0AA0 |
| | WinCC Comfort V12 SP1 | 6AV2101-0AA01-0AA5 |
| | WinCC Advanced V12 SP1 | 6AV2102-0AA01-0AA5 |
| | WinCC Professional 512 PowerTags V12 SP1 | 6AV2103-0DA01-0AA5 |
| | WinCC Professional 4096 PowerTags V12 SP1 | 6AV2103-0HA01-0AA5 |
| | WinCC Professional max. PowerTags V12 SP1 | 6AV2103-0XA01-0AA5 |

C.9 Documentation

Table C- 15 S7-1200 documentation

| Printed documentation | Language | Order Number |
|---|----------|---------------------|
| S7-1200 Programmable Controller System Manual | German | 6ES7 298-8FA30-8AH0 |
| | English | 6ES7 298-8FA30-8BH0 |
| | French | 6ES7 298-8FA30-8CH0 |
| | Spanish | 6ES7 298-8FA30-8DH0 |
| | Italian | 6ES7 298-8FA30-8EH0 |
| | Chinese | 6ES7 298-8FA30-8KH0 |
| S7-1200 Easy Book | German | 6ES7 298-8FA30-8AQ0 |
| | English | 6ES7 298-8FA30-8BQ0 |
| | French | 6ES7 298-8FA30-8CQ0 |
| | Spanish | 6ES7 298-8FA30-8DQ0 |
| | Italian | 6ES7 298-8FA30-8EQ0 |
| | Chinese | 6ES7 298-8FA30-8KQ0 |

Exchanging a V3.0 CPU for a V4.0 CPU

You can replace your V3.0 CPU with a V4.0 CPU (Page 142) and use your existing STEP 7 project that you designed for the V3.0 CPU. You might also want to check for and apply firmware updates (Page 133) to your connected modules.

Note

No device exchange possible from V4.0 to V3.0

You can exchange a V3.0 CPU for a V4.0 CPU, but you cannot exchange a V4.0 CPU for a V3.0 CPU after you download the configuration. If you want to view or otherwise use your existing STEP 7 V3.0 project, make an archive of your STEP 7 V3.0 project prior to the device exchange.

Note that if you have not downloaded the exchanged device configuration, you can undo it. After downloading, however, you cannot undo the exchange from V3.0 to V4.0.

You need to be aware of some configuration and operational changes between the two CPU versions:

Organization blocks

With V4.0, you can configure OB execution to be interruptible or non-interruptible (Page 94). For projects from former V3.0 CPUs, STEP 7 sets all OBs by default to be non-interruptible.

STEP 7 sets all OB priorities (Page 94) to the values they were in the V3.0 CPU STEP 7 project.

You can subsequently change the interruptability or priority settings if you choose.

The Diagnostic error interrupt OB (Page 89) start information references the submodule as a whole if no diagnostics event is pending.

CPU password protection

STEP 7 sets the password protection level (Page 190) for the V4.0 CPU to be the equivalent password protection level that was set for the V3.0 CPU, and assigns the V3.0 password to the "Full access (no protection)" password for the V4.0 CPU:

| V3.0 protection level | V4.0 access level |
|-----------------------|-----------------------------|
| No protection | Full access (no protection) |
| Write protection | Read access |
| Write/read protection | HMI access |

Note that the V4.0 access level "No access (complete protection)" did not exist for V3.0.

Web server

If you exchange a V3.0 CPU for a V4.0 CPU, your Web server project settings (Page 603) for activating the Web server and whether or not to require HTTPS access will be the same as they were in V3.0. You can then configure users, privileges, passwords (Page 604), and languages (Page 603) as needed to use the Web server. If you do not configure users with additional privileges, then you are limited as to what you can view from the standard Web pages (Page 609). The S7-1200 V4.0 CPU does not support the former pre-configured "admin" user and password.

Formerly, the Data log Web server page provided a "Download and Clear" operation. The V4.0 Web server File browser page (Page 622), from which you access data logs, no longer provides this feature. Instead, the Web server provides the ability to download, rename, and delete data log files.

Transfer card incompatibility

You cannot use a V3.0 transfer card (Page 125) to transfer a V3.0 program to a V4.0 CPU. You must open the V3.0 project in STEP 7, change the device to a V4.0 CPU (Page 142), and download the STEP 7 project to your V4.0 CPU. After you have changed your project to a V4.0 project, you can then make a V4.0 transfer card for subsequent program transfers.

GET/PUT communication

By default, GET/PUT communication was enabled in V3.0. When you replace your V3.0 CPU with a V4.0 CPU (Page 142), you see a message in the compatibility information section stating that GET/PUT is enabled.

Motion control support

S7-1200 V4.0 CPUs do not support the V1.0 and V2.0 motion libraries. If you perform a device exchange for a STEP 7 project with V1.0 or V2.0 motion libraries, the device exchange substitutes compatible V3.0 motion control instructions (Page 455) for the V1.0 or V2.0 motion library instructions at compile.

If you perform a device exchange for a STEP 7 project that contains two different motion control instruction versions (V3.0 and V4.0), the device exchange substitutes compatible V4.0 motion control instructions (Page 455) at compile.

During a device exchange from V3.0 to V4.0, the motion control Technological Object (TO) version automatically changes to V4.0. The TO structure is different between V3.0 and V4.0. All associated blocks change as well. Block interfaces, watch tables, and traces update to the new V4.0 structure. You can find the differences between the V3.0 and V4.0 motion control axis parameters in the following two tables:

| V3.0 | V4.0 |
|---|---|
| Config.General.LengthUnit | Units.LengthUnit |
| Config.Mechanics.PulsesPerDriveRevolution | Actor.DriveParameter.PulsesPerDriveRevolution |
| Config.Mechanics.LeadScrew | Mechanics.LeadScrew |
| Config.Mechanics.InverseDirection | Actor.InverseDirection |
| Config.DynamicLimits.MinVelocity | DynamicLimits.MinVelocity |

| V3.0 | V4.0 |
|--|---|
| Config.DynamicLimits.MaxVelocity | DynamicLimits.MaxVelocity |
| Config.DynamicDefaults.Acceleration | DynamicDefaults.Acceleration |
| Config.DynamicDefaults.Deceleration | DynamicDefaults.Deceleration |
| Config.DynamicDefaults.EmergencyDeceleration | DynamicDefaults.EmergencyDeceleration |
| Config.DynamicDefaults.Jerk | DynamicDefaults.Jerk |
| Config.PositionLimits_SW.Active | PositionLimitsSW.Active |
| Config.PositionLimits_SW.MinPosition | PositionLimitsSW.MinPosition |
| Config.PositionLimits_SW.MaxPosition | PositionLimitsSW.MaxPosition |
| Config.PositionLimits_HW.Active | PositionLimitsHW.Active |
| Config.PositionLimits_HW.MinSwitchedLevel | PositionLimitsHW.MinSwitchLevel |
| Config.PositionLimits_HW.MaxSwitchedLevel | PositionLimitsHW.MaxSwitchLevel |
| Config.Homing.AutoReversal | Homing.AutoReversal |
| Config.Homing.Direction | Homing.ApproachDirection |
| Config.Homing.SideActiveHoming | Sensor[1].ActiveHoming.SideInput |
| Config.Homing.SidePassiveHoming | Sensor[1].PassiveHoming.SideInput |
| Config.Homing.Offset | Sensor[1].ActiveHoming.HomePositionOffset |
| Config.Homing.FastVelocity | Homing.ApproachVelocity |
| Config.Homing.SlowVelocity | Homing.ReferencingVelocity |
| MotionStatus.Position | Position |
| MotionStatus.Velocity | Velocity |
| MotionStatus.Distance | StatusPositioning.Distance |
| MotionStatus.TargetPosition | StatusPositioning.TargetPosition |
| StatusBits.SpeedCommand | StatusBits.VelocityCommand |
| StatusBits.Homing | StatusBits.HomingCommand |

The only "commandtable" parameter that is renamed is the array with the commands:

| V3.0 | V4.0 |
|------------------|-----------|
| Config.Command[] | Command[] |

Note: The array "Command[]" is a UDT of the type "TO_CmdTab_Config_Command" in V3.0 and "TO_Struct_Command" in V4.0.

Instruction changes

The following instructions have changes in parameters or behavior:

- RDREC and WRREC (Page 315)
- CONV (Page 244)

HMI panel communication

If you had one or more HMI panels (Page 32) connected to your S7-1200 V3.0 CPU, the communication to the S7-1200 V4.0 CPU depends on the type of communication you use and the firmware version of the HMI panel. Recompile and download your project to the CPU and the HMI and/or update your HMI firmware.

Requirement to recompile program blocks

After exchanging a V3.0 CPU for a V4.0 CPU, you must recompile all program blocks before you can download them to the V4.0 CPU. Additionally, if any of the blocks have know-how protection (Page 193) or copy protection bound to a PLC serial number (Page 195), you must remove the protection before you compile and download the blocks. (You do not, however, need to deactivate copy protection bound to a memory card.) After the download, you can reconfigure the know-how protection and/or PLC serial number copy protection. Note that if your project includes any blocks with know-how protection that an OEM (Original Equipment Manufacturer) provided, you must contact the OEM to provide V4.0 versions of those blocks.

In general, Siemens recommends that you recompile the hardware configuration and software in STEP 7 and download to all devices in your project after the device exchange.

Index

&

& box (FBD AND logic operation), 203

(

-()- (assignment), 203

-(N)- (set operand on negative signal edge, 209

-(P)- (set operand on positive signal edge, 209

-(/)- (negate assignment), 203

-(R) (reset output), 206

-(RESET_BF) (reset bit field), 207

-(S) (set output), 206

-(SET_BF) (set bit field), 207

/

/= box (FBD negate assignment), 203

|

-|/|- (normally closed contact), 203

-||- (normally open contact), 203

-|N|- (scan operand for negative signal edge), 209

-|NOT|- (invert RLO), 203

-|P|- (scan operand for positive signal edge), 209

=

= box (FBD assignment), 203

>

>=1 box (FBD OR logic operation), 203

A

ABS (formabsolute value), 233

AC

grounding, 72

isolation guidelines, 71

wiring guidelines, 70, 72

Access protection, CPU, 190

Accessing

data logs from PC, 623

user-defined Web pages, 644

ACOS (form arccosine value), 236

ACT_TINT (activate time of day interrupt), 339

Active/passive communication

configuring the partners, 150, 593

connection IDs, 514

parameters, 153

Active/Passive connection, 512

Ad hoc mode, TCP and ISO on TCP, 518

ADD (add), 230

Add new device

CPU, 138

detect existing hardware, 140

unspecific CPU, 140

Adding inputs or outputs to LAD or FBD

instructions, 41

Addressing

Boolean or bit values, 106

individual inputs (I) or outputs (Q), 106

memory areas, 105

process image, 105

Air flow, 50

Aliases in user-defined Web pages, 634

Analog I/O

configuration, 147

conversion to engineering units, 39, 110, 253

input representation (current), 917, 951

input representation (voltage), 916, 950

output representation (current), 918, 952

output representation (voltage), 917, 951

status indicators, 785

step response times (CPU), 842, 852, 862, 873, 888

step response times (SB), 950

step response times (SM), 916

Analog signal boards

SB 1231, 946

SB 1231 RTD, 957

SB 1231 Thermocouple, 953

SB 1232, 948

Analog signal modules

SM 1231, 907

SM 1231 RTD, 925

SM 1231 Thermocouple, 919

SM 1232, 910

SM 1234, 913

AND (logic operation), 275

Approvals

- ATEX, 830
- CE, 829
- C-Tick, 831
- cULus, 830
- FM, 830
- Korea Certification, 831
- Maritime, 831

Arrays, accessing members, 241

AS-i

- add AS-i master CM1243-2 module, 577
- add AS-i slave, 577
- address, 579
- AS-i master CM 1243-2, 576
- distributed I/O instructions, 314
- network connection, 578
- RDREC (read data record), 315
- slave configuration with STEP 7, 583
- slave configuration without STEP 7, 582
- system assignment, 582
- system assignment of slave addresses, 582
- transferring analog values, 583
- transferring digital values, 583
- WRREC (write data record), 315

ASIN (form arcsinevalue), 236

Assigning enum types, user-defined Web pages, 635

ATEX approval, 830

ATH (convert ASCII string to hexadecimal number), 304

ATTACH (attach an OB to an interrupt event), 331

AWP commands, 627

- combining definitions, 638
- defining an enum type, 635
- generating fragments, 637
- importing fragments, 638
- reading special variables, 631
- referencing an enum type, 635
- using an alias, 634
- writing special variables, 633
- writing variables, 630

AWP_Enum_Def, 635

AWP_Enum_Ref, 635

AWP_Import_Fragment, 638

AWP_In_Variable, 630, 633

AWP_Out_Variable, 631

AWP_Start_Fragment, 637

B

Basic panels (HMI), 32

Battery board (BB)

- BB 1297, 962

inserting battery, 963

Baud rate, 673

BB 1297, 962

Binding to a CPU or memory card, 195

Bit logic, 203, 206, 209

Blocks

block calls, 77

calling an FB or FC with SCL, 183

consistency check, 201

copying blocks from an online CPU, 197

counters (quantity and memory requirements), 25, 839, 849, 859, 869, 881

data block (DB), 77

download, 196

events, 94

function (FC), 77, 174

function block (FB), 77, 175

initial value of an FB, 175

instance data block (DB), 175

interrupts, 25, 94, 838, 848, 858, 869, 881

linear and structured programs, 170

monitoring, 25, 838, 848, 858, 869, 881

nesting depth, 25, 77, 838, 848, 858, 869, 881

number of code blocks, 25, 838, 848, 858, 869, 880

number of OBs, 25, 94, 838, 848, 858, 869, 881

organization blocks (OBs), 25, 77, 85, 94, 838, 848, 858, 869, 881

password protection, 193

single instance or multi-instance DB, 175

size of the user program, 25, 77, 838, 848, 858, 869, 880

start-up OBs, 94

timers (quantity and memory requirements), 25, 839, 849, 859, 869, 881

types of code blocks, 77

valid FC, FB, and DB numbers, 77

Boolean or bit values, 106

Break, 676, 677

BUFFER parameter, SEND_PTP, 696

Bus connector, 29

C**Cable**

expansion, 981

Network communication, 670

CALCULATE (calculate), 229

scaling analogs, 39

using for complex equations, 39

Calendar, 283

Call structure, 201

Calling code blocks within the user program, 172

- CAN_DINT (cancel time-delay interrupt), 342
- CAN_TINT (cancel time of day interrupt), 339
- CANopen modules
 - 021620-B, 021630-B, 983
- Capturing values from an online DB, 797
- CB 1241
 - termination and bias, 671
- CB 1241 RS485, 974
- CE approval, 829
- CEIL (generate next higher integer from floating-point number), 250
- Certificate Import Wizard, 666
- Change device, 142
- Changing settings for STEP 7, 43
- Char (character data type), 115
- Character position, message length, 682
- Character sequence
 - message end, 681
 - message start, 677
- Chars_TO_Strg (convert array of CHAR to character string), 302
- Clearance, airflow and cooling, 50
- Clock
 - RD_LOC_T (read local time), 287
 - RD_SYS_T (read time-of-day), 287
 - time-of-day clock, 104
 - WR_LOC_T (set local time), 287
 - WR_SYS_T (set time-of-day), 287
- Clock memory byte, 103
- Code block
 - binding to a CPU or memory card, 195
 - block calls, 77
 - calling code blocks within the user program, 172
 - copy protection, 195
 - counters (quantity and memory requirements), 25, 839, 849, 859, 869, 881
 - DB (data block), 77, 176
 - FB (function block), 77, 175
 - FC (function), 77, 174
 - initial value of an FB, 175
 - instance data block (DB), 175
 - interrupts, 25, 838, 848, 858, 869, 881
 - know-how protection, 193
 - linear and structured programs, 170
 - monitoring, 25, 838, 848, 858, 869, 881
 - nesting depth, 25, 838, 848, 858, 869, 881
 - number of code blocks, 25, 838, 848, 858, 869, 880
 - number of OBs, 25, 838, 848, 858, 869, 881
 - organization blocks (OBs), 25, 172, 838, 848, 858, 869, 881
 - size of the user program, 25, 838, 848, 858, 869, 880
 - timers (quantity and memory requirements), 25, 839, 849, 859, 869, 881
 - types of code blocks, 77
 - valid FC, FB, and DB numbers, 77
- Cold junction compensation, thermocouple, 922, 955
- Columns and headers in task cards, 42
- Communication
 - active/passive, 150, 153, 593
 - AS-i address, 579
 - communication load, 98
 - configuration, 150, 153, 593
 - connection IDs, 514
 - cycle time, 98
 - flow control, 674
 - hardware connection, 550
 - IP address, 159
 - MAC address, 159
 - network, 550
 - network connection, 149
 - number of connections (PROFINET), 511
 - parameters, 153
 - polling architecture, 703
 - PROFIBUS address, 574
 - PROFINET and PROFIBUS, 509
 - send and receive parameters, 675
 - TCON_Param, 153
 - time synchronization property (PROFINET), 165
- Communication board (CB)
 - add modules, 141
 - CB 1241 RS485, 974
 - comparison chart, 26
 - configuration of parameters, 147
 - device configuration, 137
 - installation, 58
 - LED indicators, 669, 783
 - overview, 29
 - programming, 702
 - removal, 58
 - RS485, 669
- Communication interfaces
 - add modules, 141
 - CB 1241 RS485, 974
 - CM 1241 RS232, 975
 - comparison chart of the modules, 26
 - configuration, 672
 - device configuration, 137
 - LED indicators, 783
 - programming, 702
 - RS232 and RS485, 669
- Communication module (CM)
 - add AS-i master CM1243-2 module, 577
 - add CM 1243-5 (DP master) module, 572

- add modules, 141
- CM 1241 RS232, 975
- CM 1241 RS422/RS485, 976
- comparison chart, 26
- configuration for PtP example program, 705
- configuration of parameters, 147
- data reception, 697
- device configuration, 137
- installation, 62
- LED indicators, 669, 783
- overview, 29
- power requirements, 985
- programming, 702
- removal, 62
- RS232 and RS485, 669
- Communication processor (CP)
 - add modules, 141
 - comparison chart, 26
 - configuration of parameters, 147
 - device configuration, 137
 - overview, 29
- Communication standard Web page, 620
- Compact switch module
 - CSM 1277, 982
- Compare values, 226
- Comparing and synchronizing online/offline CPUs, 794
- Comparing code blocks, 794
- Comparison chart
 - CPU models, 24
 - HMI devices, 32
 - modules, 26
- Computer requirements, 36
- CONCAT (combine character strings), 307
- Configuration
 - add modules, 141
 - AS-i, 579
 - AS-i port, 578
 - communication interfaces, 672
 - communication load, 98
 - CPU parameters, 142
 - cycle time, 97
 - discover, 140
 - download, 196
 - Ethernet port, 159
 - HSC (high-speed counter), 418
 - IP address, 159
 - MAC address, 159
 - modules, 147
 - network connection, 149
 - PLC to PLC communication, 553
 - ports, 672
 - PROFIBUS, 574
 - PROFIBUS address, 574
 - PROFINET, 159
 - receive message, 676
 - RS422, operating modes, 707
 - RS485 operating modes, 709
 - startup parameters, 127
 - time synchronization property (PROFINET), 165
- Configuration of transmitted message, 675, 675
- Configuration, user-defined Web pages
 - setting up multiple languages, 659
 - STEP 7 configuration, 641
- Connection contacts
 - Maximum current carrying capacity, 972
- Connections
 - configuration, 153
 - connection IDs, 514
 - Ethernet protocols, 591
 - number of connections (PROFINET), 511
 - partners, 150, 593
 - S7 connection, 591
 - types of communication, 509
 - types, multi-node connections, 591
 - Web server, 664
- Connector, installation and removal, 63
- Consistency check, 201
- Constraints
 - user-defined Web pages, 644
 - Web server, 664
- Contact information, 3, 142
- Control DB for user-defined Web pages
 - global commands, 660
 - parameter to WWW instruction, 642
 - request commands and states, 660
- CONV (convert value), 245
- Conversion (SCL instructions), 245
- Cookie restrictions, standard Web pages, 666
- Cookie, siemens_automation_language, 657
- Cooling, 50
- Copy protection
 - binding to a CPU or memory card, 195
- Copying blocks from an online CPU, 197
- COS (form cosine value), 236
- Counters
 - CTD (count down), 220
 - CTRL_HSC (control high-speed counter), 409
 - CTU (count up), 220
 - CTUD (count up and down), 220
 - HSC configuration, 418
 - HSC operation, 411
 - operation (standard counters), 221
 - quantity, 25, 839, 849, 859, 869, 881
 - size, 25, 839, 849, 859, 869, 881

CPU

- access protection, 190
- add new device, 138
- AS-i, 578
- AS-i address, 579
- AS-i port, 578
- assigning an IP address to an online CPU, 158
- capturing values of a DB, 797
- communication, 512
- communication load, 98
- comparing and synchronizing blocks, 794
- copying blocks from an online CPU, 197
- cycle time configuration, 98
- device configuration, 137
- displaying the MAC and IP addresses, 163
- download, 196
- download to device, 163
- empty transfer card, 136
- enable outputs in STOP mode, 800
- Ethernet port, 159
- expansion cable, 64
- force, 801, 802
- going online, 786
- grounding, 72
- HSC configuration, 418
- Identification standard Web page, 615
- inductive loads, 74
- installation, 55, 56
- IP address, 159
- isolation guidelines, 71
- know-how protection, 193
- lamp loads, 73
- LED indicators, 783
- lost password, 136
- MAC address, 159, 163
- monitoring, 796
- network connection, 149
- online, 789, 796
- operating modes, 81
- operating panel (online CPU), 792
- operator panel, 44
- password protection, 190
- power budget, 51
- power requirements, 985
- processing the OBs, 172
- PROFIBUS, 574
- PROFIBUS address, 574
- PROFINET, 159
- PROFINET IO, 558
- program execution, 77
- pulse outputs, 365
- recover from a lost password, 136
- reset to factory settings, 789
- resetting the start values of a DB, 797
- RTM (runtime meters), 291
- RUN/STOP buttons, 44
- RUN/STOP modes, 792
- Security levels, 190
- startup parameters, 127
- startup processing, 84
- terminal block connector, 63
- thermal zone, 50, 54
- time synchronization property, 165
- types of communication, 509
- unspecific CPU, 140
- watch table, 798
- wiring guidelines, 70, 72
- CPU configuration
 - communication to HMI, 552
 - cycle time monitoring, 97
 - module properties, 147
 - multiple CPUs, 553
 - operational parameters, 142
 - pulse channels, 367
- CPU memory card
 - inserting, 125
 - program card, 131
 - transfer card, 128
 - uses, 124
- CPU properties, user-defined Web pages
 - setting up multiple languages, 659
 - STEP 7 configuration, 641
- CPUs
 - add modules, 141
 - communication boards (CB), 29
 - comparison chart, 24
 - CPU 1211C AC/DC/Relay, 837
 - CPU 1211C DC/DC/DC, 837
 - CPU 1211C DC/DC/Relay, 837
 - CPU 1212C AC/DC/Relay, 847
 - CPU 1212C DC/DC/DC, 847
 - CPU 1212C DC/DC/Relay, 847
 - CPU 1214C AC/DC/Relay, 857
 - CPU 1214C DC/DC/DC, 857
 - CPU 1214C DC/DC/Relay, 857
 - CPU 1215C AC/DC/Relay, 867
 - CPU 1215C DC/DC/DC, 867
 - CPU 1215C DC/DC/Relay, 867
 - CPU 1217C DC/DC/DC, 879
 - number of communication connections, 511
 - overview, 23
 - signal boards (SB), 29
 - step response times, 842, 852, 862, 873, 888
- Creating a network connection

- between PLCs, 149
- Creating user-defined Web page DBs, 642
- Creating user-defined Web pages, 626
- Cross-reference to show usage, 200
- CSM 1277 compact switch module, 982
- CTD (count down), 220
- C-Tick approval, 831
- CTRL_HSC (control high-speed counter), 409
- CTS, 674
- CTU (count up), 220
- CTUD (count up and down), 220
- cULus approval, 830
- Customer support, 3
- Cycle time
 - configuration, 98
 - monitoring, 792
 - overview, 97
- Cyclic interrupt OB, 87

D

- Data block
 - capturing values, 797
 - CONF_DATA, 544
 - global data block, 105, 176
 - instance data block, 105
 - optimized access, 177
 - organization blocks (OBs), 172
 - overview, 77, 176
 - READ_DBL (read from data block in load memory), 401
 - resetting the start values, 797
 - single FB with multiple instance DBs, 176
 - standard access, 177
 - structure, 77
 - WRIT_DBL (write to data block in load memory), 401
- Data blocks for user-defined Web pages
 - importing fragments, 638
- Data exchange between IO systems, 565
- Data handling block (DHB), 176
- Data log
 - data log overview, 380
 - data record structure, 381
 - DataLogClose (close data log), 389
 - DataLogCreate (create data log), 382
 - DataLogNewFile (data log in new file), 390
 - DataLogOpen (open data log), 385
 - DataLogWrite (write data log), 387
 - example program, 396
 - limits to Data log size, 393
 - viewing Data logs, 392

- Data Logs standard Web page, 623
- Data transmission, initiating, 694
- Data types, 110
 - Any (pointer), 119
 - arrays, 116
 - Bool, Byte, Word, and DWord, 111
 - Char (character) and string, 115
 - PLC data type editor, 117
 - Pointer (pointer), 118
 - pointer data type overview, 118
 - Real, LReal (floating-point real), 112
 - Struc, 117
 - Time, Date, TOD (time of day), DTL (date and time long), 113
 - USInt, SInt, UInt, Int, UDInt, Dint (integer), 112
 - Variant (pointer), 120
- Date
 - Date data type, 113
 - DTL (date and time long data type), 114
 - SET_TIMEZONE (set time zone), 290
 - T_ADD (add times), 284
 - T_COMBINE (combine times), 285
 - T_CONV (convert times and extract), 283
 - T_DIFF (time difference), 285
 - T_SUB (subtract times), 284
- Daylight saving time TimeTransformationRule, 289
- DB (data block), (Data block)
- DC
 - grounding, 72
 - inductive loads, 74
 - isolation guidelines, 71
 - outputs, 835
 - wiring guidelines, 70, 72
- Debugging
 - downloading in RUN mode, 803, 811
- DEC (decrement), 232
- DECO (decode), 276
- Defining enum types, user-defined Web pages, 635
- Degree of protection, 834
- DELETE (delete characters in a character string), 310
- Designing a PLC system, 169, 170
- DETACH (detach an OB from an interrupt even)t, 331
- Device
 - PROFINET IO, 558
- Device configuration, 137, 551
 - add modules, 141
 - add new device, 138
 - AS-i, 579
 - AS-i port, 579
 - changing a device type, 142
 - configuring the CPU, 142
 - configuring the modules, 147

- discover, 140
 - download, 196
 - Ethernet port, 159
 - network connection, 149
 - PROFIBUS, 574
 - PROFINET, 159
 - time synchronization property (PROFINET), 165
 - unplugged modules, 47
 - Device exchange, 142
 - Device names
 - PROFINET IO, 559
 - DeviceStates (read module status of an I/O system), 347
 - Diagnostic error interrupt OB, 89
 - Diagnostic standard Web page, 616
 - Diagnostics
 - buffer, 103
 - cycle time, 792
 - DeviceStates (read module status of an I/O system), 347
 - diagnostics buffer, 793
 - GET_DIAG (read diagnostic information), 358
 - LED (read LED status), 346
 - LED indicators, 783
 - memory usage, 792
 - ModuleStates (read module status information of a module), 353
 - status indicator, 102
 - watch table, 798
 - Digital I/O
 - configuration, 147
 - pulse catch, 147
 - status indicators, 784
 - Digital input filter time, 144
 - Digital signal boards
 - SB 1221, 935
 - SB 1222, 937
 - SB 1223, 940, 943
 - Digital signal modules
 - SM 1221, 892
 - SM 1222, 894, 895
 - SM 1223, 900, 904
 - DIN rail, 55
 - Directories, languages for user-defined Web pages, 656
 - DIS_AIRT (disable execution of higher priority interrupts and asynchronous error events), 344
 - Discover to upload an online CPU, 140
 - Displaying the MAC and IP addresses, 163
 - DIV (divide), 230
 - Documentation, 4
 - Download in RUN mode
 - compile errors, 807
 - considerations, 811
 - download without reinitialization, 808
 - downloading selected blocks, 806
 - extended block interface, 808
 - failed download, 811
 - global memory reserve settings, 810
 - initiating from STEP 7, 805
 - memory reserve and retentive memory reserve, 808
 - overview, 803
 - prerequisites, 804
 - restrictions, 810
 - Downloading
 - displaying the MAC and IP addresses, 163
 - firmware update, 133
 - project, 196
 - Siemens security certificate to PC, 613, 666
 - user program, 196
 - user-defined Web page DBs, 643
 - DPNRM_DG, 328
 - DPRD_DAT (read consistent data of a DP standard slave), 326
 - DPWR_DAT (write consistent data of a DP standard slave), 326
 - Drag and drop between editors, 43
 - Drives
 - connecting a, 724
 - general drive setup requirements, 724
 - setting up MM4 drive, 726
- ## E
- Edit in RUN mode, (Download in RUN mode)
 - Electromagnetic compatibility, 833
 - Electromagnetic compatibility (EMC), 832
 - EN and ENO (power flow), 188
 - EN_AIRT (enable execution of higher priority interrupts and asynchronous error events), 344
 - ENCO (encode), 276
 - End conditions, 679
 - End message character, 681
 - ENDIS_PW (enable/disable passwords), 259
 - Enum types in user-defined Web pages, 635, 635
 - Environmental
 - operating conditions, 833
 - transport and storage conditions, 833
 - Error codes
 - common errors for extended instructions, 407
 - RALRM, 322
 - RDREC, 322
 - WRREC, 322
 - Errors

- diagnostic errors, 90
- time errors, 88
- Ethernet
 - ad hoc mode, 518
 - connection IDs, 514
 - CSM 1277 compact switch module, 982
 - DPNRM_DG (read diagnostic data from a DP slave), 328
 - DPRD_DAT (read consistent data of a DP standard slave), 326
 - DPWR_DAT (write consistent data of a DP standard slave), 326
 - GET (read data from a remote CPU), 587
 - IP address, 159
 - MAC address, 159
 - network connection, 149
 - number of communication connections, 511
 - overview, 517
 - PUT (write data to a remote CPU), 587
 - RALRM (receive interrupt), 318
 - RDREC (read data record), 315
 - T_CONFIG (configure interface), 541
 - TCON (establish communication connection), 527
 - TDISCON (terminate communication connection), 527
 - TRCV (receive data via communication connection), 527
 - TRCV_C (receive data via Ethernet (TCP)), 520
 - TSEND (send data via communication connection), 527
 - TSEND_C (send data via Ethernet (TCP)), 520
 - TURCV (receive data via Ethernet (UDP)), 535
 - TUSEND (send data via Ethernet (UDP)), 535
 - types of communication, 509
 - WRREC (write data record), 315
- Ethernet protocols, 517
 - multi-node connections, 591
- Event execution, 94
- Example
 - Modbus slave, 764
 - PtP communication, 704
 - PtP communication, configuration, 705
 - PtP communication, running, 712
 - PtP communication, STEP 7 programming, 710
 - PtP communication, terminal emulator, 711
 - user-defined Web pages, 645
- EXP (form exponential value), 236
- Expandable instructions, 42
- Expanding the capabilities of the S7-1200, 26
- Expansion cable, 981
 - installation, 64
 - removal, 64
- EXPT (exponentiate), 236
- Extended block interface
 - download in RUN mode, 808
- F**
- F_TRIG (set tag on negative signal edge), 210
- Factory settings reset, 789
- FAQs, 4
- Favorites toolbar, 38
- FB (function block)
 - overview, 77
- FBD (function block diagram), 181
- FC (function), 77, 174
- FieldRead (read field), 240
- FieldWrite (write field), 240
- FILL_BLK (fill block), 242
- Filter time, 144
- FIND (find characters in a character string), 313
- Firmware update, 133
 - from STEP 7, 791
 - from Web server, 619
- First scan indicator, 102
- Fixed length, 681
- FLOOR (generate next lower integer from floating-point number), 250
- Flow control, 673, 674
 - configuration, 673
- FM approval, 830
- Folders, languages for user-defined Web pages, 656
- Force, 801, 802
 - I memory, 801, 802
 - inputs and outputs, 802
 - memory card, 124
 - peripheral inputs, 801, 802
 - scan cycle, 802
 - watch table, 798
- Force table
 - addressing peripheral inputs, 801
 - force, 801
 - force operation, 802
- FRAC (return fraction), 236
- Fragment DBs (user-defined Web pages)
 - generating, 642
- Fragments (user-defined Web pages)
 - creating from AWP command, 637
 - importing with AWP command, 638
- Freeport protocol, 671
- Frequency, clock bits, 103
- Function (FC)
 - calling code blocks within the user program, 172
 - know-how protection, 193

- linear and structured programs, 170
- overview, 77, 174
- valid FC numbers, 77

Function block (FB)

- calling code blocks within the user program, 172
- initial value, 175
- instance data block, 175
- know-how protection, 193
- linear and structured programs, 170
- output parameters, 175
- overview, 77, 175
- single FB with multiple instance DBs, 176
- valid FB numbers, 77

Functionality

- I-device, 561

G

Generating user-defined Web page DBs, 642

GET

- configuring the connection, 151

GET (read data from a remote CPU), 587

GET_DIAG (read diagnostic information), 358

GET_ERROR (get error locally), 263

GET_ERROR_ID (get error ID locally), 265

Global data block, 105, 176

Global library

- USS protocol overview, 712

GSD file, 568

Guidelines

- CPU installation, 56
- grounding, 72
- inductive loads, 74
- installation, 49
- installation procedures, 55
- isolation, 71
- lamp loads, 73
- wiring guidelines, 70, 72

H

Hardware configuration, 137

- add modules, 141
- add new device, 138
- AS-i, 579
- AS-i port, 579
- configuring the CPU, 142
- configuring the modules, 147
- discover, 140
- download, 196
- Ethernet port, 159

- network connection, 149
- PROFIBUS, 574
- PROFINET, 159

Hardware flow control, 674

Hardware interrupt OB, 87

High potential isolation test, 834

High-speed counter, 409

- cannot be forced, 802
- configuration, 418
- operation, 411

HMI devices

- configuring PROFINET communication, 552
- network connection, 149
- overview, 32

Hotline, 3

HSC (high-speed counter)

- configuration, 418
- operation, 411

HTA (convert hexadecimal number to ASCII string), 304

HTML pages

- listing, user-defined Web page example, 650
- user-defined, 625

HTML pages, user-defined

- accessing S7-1200 data, 627
- developing, 626
- language locations, 659
- page locations, 641
- refreshing, 627

HTTP connections, Web server, 664

I

I memory

- force, 801
- force operation, 802
- force table, 801
- monitor, 796
- monitor LAD, 797
- peripheral input addresses (force table), 801
- watch table, 796

I/O

- addressing, 109
- analog input representation (current), 917, 951
- analog input representation (voltage), 916, 950
- analog output representation (current), 918, 952
- analog output representation (voltage), 917, 951
- analog status indicators, 785
- digital status indicators, 784
- force operation, 802
- inductive loads, 74
- monitoring status in LAD, 797

- monitoring with a watch table, 798
- step response times (CPU), 842, 852, 862, 873, 888
- step response times (SB), 950
- step response times (SM), 916
- Identification standard Web page, 615
- I-device
 - configuring with GSD file, 568
- I-device (intelligent IO device)
 - configuring, 567
 - functionality, 561
 - lower-level PN IO system, 562
 - Properties, 562
- Idle line, 676, 677
- Importing Siemens security certificate, 666
- IN_Range (value within range), 227
- INC (increment), 232
- Incompatible CPU version error, 784
- Indexing arrays with variables, 241
- Inductive loads, 74
- Industrial environments
 - approvals, 831
- Information resources, 4
- Initial values
 - capturing and resetting the start values of a DB, 797
- Input filter time, 144
- Input simulators, 978
- Inputs
 - pulse catch bits, 146
- Inputs and outputs
 - monitoring, 796
- INSERT (insert characters in a character string), 311
- Inserting a device
 - unspecific CPU, 140
- Inserting instructions
 - drag and drop, 38
 - drag and drop between editors, 43
 - favorites, 38
- Inserting the memory card into CPU, 125
- Installation
 - air flow, 50
 - clearance, 50
 - communication board (CB), 58
 - communication module (CM), 62
 - cooling, 50
 - CPU, 56
 - expansion cable, 64
 - grounding, 72
 - guidelines, 49
 - inductive loads, 74
 - isolation guidelines, 71
 - lamp loads, 73
 - mounting dimensions, 54
 - overview, 49, 55
 - power budget, 51
 - requirements, 36
 - signal board (SB), 58
 - signal module (SM), 60
 - signal modules (SM), 29
 - terminal block connector, 63
 - thermal zone, 50, 54
 - TS Adapter and TS module, 66
 - TS Adapter on a DIN rail, 69
 - TS Adapter on a wall, 69
 - TS Adapter SIM card, 67
 - wiring guidelines, 70, 72
- Instance data block, 105
- Instructions
 - & box (FBD AND logic operation), 203
 - (-) - (assignment), 203
 - (/) - (negate assignment), 203
 - (N) - (set operand on negative signal edge), 209
 - (P) - (set operand on positive signal edge), 209
 - (R) (reset output), 206
 - (RESET_BF) (reset bit field), 207
 - (S) (set output), 206
 - (SET_BF) (set bit field), 207
 - /= box (FBD negate assignment), 203
 - /| - (normally closed contact), 203
 - || - (normally open contact), 203
 - |N| - (scan operand for negative signal edge), 209
 - |NOT| - (invert RLO), 203
 - |P| - (scan operand for positive signal edge), 209
 - = box (FBD assignment), 203
 - ABS (form absolute value), 233
 - ACOS (form arccosine value), 236
 - ACT_TINT (activate time of day interrupt), 339
 - ADD (add), 230
 - adding inputs or outputs to LAD or FBD instructions, 41
 - AND (logic operation), 275
 - AS-i distributed I/O, 314
 - ASIN (form arcsine value), 236
 - ATAN (form arctangent value), 236
 - ATH (convert ASCII string to hexadecimal number), 304
 - ATTACH (attach an OB to an interrupt event), 331
 - CALCULATE, 39
 - CALCULATE (calculate), 229
 - calendar, 283
 - CAN_DINT (cancel time-delay interrupt), 342
 - CAN_TINT (cancel time of day interrupt), 339
 - CASE (SCL), 269

- CEIL (generate next higher integer from floating-point number), 250
- Chars_TO_Strg (convert array of CHAR to character string), 302
- clock, 287
- columns and headers, 42, 746
- common parameters, 548
- compare values, 226
- CONCAT (combine character strings), 307
- CONTINUE (SCL), 273
- CONV (convert value), 245
- COS (form cosine value), 236
- CTD (count down), 220
- CTRL_HSC (control high-speed counter), 409
- CTRL_PWM (pulse width modulation), 364
- CTU (count up), 220
- CTUD (count up and down), 220
- DataLogClose (close data log), 389
- DataLogCreate (create data log), 382
- DataLogNewFile (data log in new file), 390
- DataLogOpen (open data log), 385
- DataLogWrite (write data log), 387
- date, 283
- DEC (decrement), 232
- DECO (decode), 276
- DELETE (delete characters in a character string), 310
- DETACH (detach an OB from an interrupt event), 331
- DeviceStates (read module status of an I/O system), 347
- DIS_AIRT (disable execution of higher priority interrupts and asynchronous error events), 344
- DIV (divide), 230
- DPNRM_DG (read diagnostic data from a DP slave), 328
- DPRD_DAT (read consistent data of a DP standard slave), 326
- DPWR_DAT (write consistent data of a DP standard slave), 326
- drag and drop, 38
- drag and drop between editors, 43
- EN_AIRT (enable execution of higher priority interrupts and asynchronous error events), 344
- ENCO (encode), 276
- ENDIS_PW (enable/disable passwords), 259
- EXIT (SCL), 273
- EXP (form exponential value), 236
- expandable instructions, 42
- EXPT (exponentiate), 236
- F_TRIG (set tag on negative signal edge), 210
- favorites, 38
- FieldRead (read field), 240
- FieldWrite (write field), 240
- FILL_BLK (fill block), 242
- FIND (find characters in a character string), 313
- FLOOR (generate next lower integer from floating-point number), 250
- FOR (SCL), 270
- force, 801
- force operation, 802
- FRAC (return fraction), 236
- GET (read data from a remote CPU), 587
- GET_DIAG (read diagnostic information), 358
- GET_ERROR (get error locally), 263
- GET_ERROR_ID (get error ID locally), 265
- GOTO (SCL), 274
- HSC (high-speed counter), 411
- HTA (convert hexadecimal number to ASCII string), 304
- IF-THEN (SCL), 268
- IN_Range (value within range), 227
- INC (increment), 232
- INSERT (insert characters in a character string), 311
- inserting, 38
- INV (create ones complement), 276
- JMP (jump if RLO = 1), 254
- JMP_LIST (define jump list), 255
- JMPN (jump if RLO = 0), 254
- Label (jump label), 254
- LED (read LED status), 346
- LEFT (read the left characters of a character string), 308
- LEN (determine the length of a character string), 307
- LIMIT (set limit value), 235
- LN (form natural logarithm), 236
- LOG2GEO (Determine the slot from the hardware identifier), 404
- MAX (get maximum), 234
- MAX_LEN (maximum length of a character string), 306
- MB_CLIENT (communicate via PROFINET as Modbus TCP client), 730
- MB_COMM_LOAD (configure port on the PtP module for Modbus RTU), 747
- MB_MASTER (communicate via the PtP port as Modbus master), 749
- MB_SERVER (communicate via PROFINET as Modbus TCP server), 736
- MB_SLAVE (communicate via the PtP port as Modbus slave), 755

- MC_ChangeDynamic (change dynamic settings for the axis), 476
MC_CommandTable, 473
MC_Halt (pause axis), 462
MC_Home (home axis), 460
MC_MoveAbsolute (position axis absolutely), 464
MC_MoveJog (move axis in jog mode), 471
MC_MoveRelative (position axis relatively), 466
MC_MoveVelocity (move axis at predefined velocity), 468
MC_Power (release/block axis), 456
MC_ReadParam (read parameters of a technology object), 480
MC_Reset (confirm error), 459
MC_WriteParam (read parameters of a technology object), 478
MID (read the middle characters of a character string), 308
MIN (get minimum), 234
MOD (return remainder of division), 231
ModuleStates (read module status information of a module), 353
monitor, 796, 797
motion control, 455
MOVE (move value), 238
MOVE_BLK (move block), 238
MUL (multiply), 230
MUX (multiplex), 278
N (scan operand for negative signal edge), 209
N_TRIG (scan RLO for negative signal edge), 210
N= box and N coil (set operand on negative signal edge), 209
NEG (create twos complement), 232
NORM_X (normalize), 251
NOT_OK (check invalidity), 228
OK (check validity), 228
OR (logic operation), 275
OUT_Range (value outside range), 227
P (scan operand for positive signal edge), 209
P_TRIG (scan RLO for positive signal edge), 210
P= box and P coil (set operand on positive signal edge), 209
PID_Compact (universal PID controller with integrated tuning), 422
PORT_CFG (configure communication parameters dynamically), 686
PROFIBUS distributed I/O, 314
PROFINET distributed I/O, 314
program control (SCL), 267
PUT (write data to a remote CPU), 587
QRY_CINT (query cyclic interrupt parameters), 336
QRY_DINT (query time-delay interrupt status), 342
QRY_TINT (query status of time of day interrupt), 340
R (reset output), 206
R_TRIG (set tag on positive signal edge), 210
RALRM (receive interrupt), 318
RCV_CFG (configure serial receive parameters dynamically), 689
RCV_PTP (enable receive messages), 697
RCV_RST (delete receive buffer), 698
RD_ADDR (determine the IO addresses from the hardware identifier), 406
RD_LOC_T (read local time), 287
RD_SYS_T (read time-of-day), 287
RDREC (read data record), 315
RE_TRIGR, 97
RE_TRIGR (restart cycle monitoring time), 262
READ_DBL (read from data block in load memory), 401
RecipeExport (recipe export), 374
RecipeImport (recipe import), 376
REPEAT (SCL), 272
REPLACE (replace characters in a character string), 312
RESET_BF (reset bit field), 207
RET (return), 258
RETURN (SCL), 274
RIGHT (read the right characters of a character string), 308
ROL (rotate left) and ROR (rotate right), 282
ROUND (round numerical value), 249
RS (reset/set flip-flop), 207
RT (reset timer), 212
RTM (runtime meters), 291
S (set output), 206
S_CONV (convert character string), 293
S_MOV (move character string), 293
SCALE_X (scale), 251
scaling analog values, 39
SCL conversion instructions, 245
SEL (select), 278
SEND_CFG (configure serial transmission parameters dynamically), 688
SEND_PTP (transmit send buffer data), 694
SET_BF (set bit field), 207
SET_CINT (set cyclic interrupt parameters), 334
SET_TIMEZONE (set time zone), 290
SET_TINTL (set date and time of day interrupt), 337
SGN_GET (Query RS232 signals), 699
SGN_SET (set RS-232 signals), 700
SHL (shift left) and SHR (shift right), 281
SIN (form sine value), 236
SQR (form square), 236

- SQRT (form square root), 236
- SR (set/reset flip-flop), 207
- SRT_DINT (start time-delay interrupt), 342
- status, 796, 797
- STP (exit program), 263
- Strg_TO_Chars (convert character string to array of CHAR), 302
- STRG_VAL (convert character string to numerical value), 293
- SUB (subtract), 230
- SWAP (swap bytes), 243
- SWITCH (jump distributor), 256
- T_ADD (add times), 284
- T_COMBINE (combine times), 285
- T_CONFIG (configure interface), 541
- T_CONV (convert times and extract), 283
- T_DIFF (time difference), 285
- T_SUB (subtract times), 284
- TAN (form tangent value), 236
- TCON (establish communication connection), 527
- TDISCON (terminate communication connection), 527
- time, 283
- timer, 212
- TM_MAIL (send email), 775
- TOF (off-delay timer), 212
- TON (on-delay timer), 212
- TONR (on-delay retentive timer), 212
- TP (pulse timer), 212
- TRCV (receive data via communication connection), 527
- TRCV_C, 556
- TRCV_C (receive data via Ethernet (TCP)), 520
- TRUNC (truncate numerical value), 249
- TSEND (send data via communication connection), 527
- TSEND_C, 555
- TSEND_C (send data via Ethernet (TCP)), 520
- TURCV (receive data via Ethernet (UDP)), 535
- TUSEND (send data via Ethernet (UDP)), 535
- UFILL_BLK (fill block uninterruptible), 242
- UMOVE_BLK (move block uninterruptible), 238
- USS status codes, 722
- USS_DRV (Swap data with drive), 716
- USS_PORT (Edit communication via USS network), 715
- USS_RPM (readout parameters from the drive), 719
- USS_WPM (change parameters in the drive), 720
- VAL_STRG (convert numerical value to character string), 293
- versions of instructions, 42, 746
- WHILE (SCL), 271
- WR_LOC_T (set local time), 287
- WR_SYS_T (set time-of-day), 287
- WRIT_DBL (write to data block in load memory), 401
- WRREC (write data record), 315
- WWW (synchronizing user-defined Web pages), 642
- XOR (logic operation), 275
- Inter-character gap, 681
- Interrupts
 - ATTACH (attach an OB to an interrupt event), 331
 - CAN_DINT (cancel time-delay interrupt), 342
 - DETACH (detach an OB from an interrupt event), 331
 - interrupt latency, 94
 - overview, 85
 - QRY_DINT (query time-delay interrupt status), 342
 - SRT_DINT (start time-delay interrupt), 342
- Intro standard Web page, 613
- INV (create ones complement), 276
- IO system
 - data exchange, 565
- IO-Link
 - address space, 822
 - changing parameters in runtime, 822
 - configuring, 821
 - data record, 823
 - device profile, 815
 - device storage, 818
 - diagnostics, 826
 - diagram, 820
 - error messages, 822, 825, 826
 - functions, 817
 - LED display, 825
 - parameters, 821
 - pin assignment, 819
 - replacing, 817
 - reset to factory settings, 818
- IO-Link Master signal module, 931
- IP address, 160, 160
 - assigning, 155, 162
 - assigning online, 158
 - configuring, 159
 - configuring the online CPU, 789
 - device configuration, 142
 - MAC address, 159
- IP router, 159
- ISO on TCP
 - ad hoc mode, 518
- ISO on TCP protocol, 517
- Isolation guidelines, 71
- ISO-on-TCP

connection configuration, 150
 connection IDs, 514
 parameters, 153

J

JavaScript restrictions, standard Web pages, 665
 JMP (jump if RLO = 1), 254
 JMP_LIST (define jump list), 255
 JMPN (jump if RLO = 0), 254

K

Know-how protection
 password protection, 193
 Korea Certification approval, 831

L

Label (jump label), 254
 LAD (ladder logic)
 monitor, 796, 797
 overview, 180
 program editor, 797
 status, 796, 797, 801
 Lamp loads, 73
 Languages, user-defined Web pages, 656
 Latency, 94
 LED (read LED status), 346
 LED indicators
 communication interface, 669, 783
 CPU status, 783
 LEFT (read the left characters of a character string), 308
 LEN (determine the length of a character string), 307
 Length
 message, 682
 Length m, 682
 Length n, 682
 LENGTH parameter, SEND_PTP, 696
 LIMIT (set limit value), 235
 Linear programming, 170
 LN (form natural logarithm), 236
 Load memory, 24
 CPU 1211C, 837
 CPU 1212C, 847
 CPU 1214C, 857
 CPU 1215C, 867
 CPU 1217C, 879
 memory card, 124
 program card, 124

 transfer card, 124
 user-defined Web pages, 644
 Local time
 RD_LOC_T (read local time), 287
 WR_LOC_T (set local time), 287
 Local/Partner connection, 512
 LOG2GEO (Determine the slot from the hardware identifier), 404
 Logging in/out
 standard Web pages, 611
 Logic analyzer, 813
 Lost password, 136

M

MAC address, 159, 163
 Manual fragment DB control, 660
 Manuals, 4
 Maritime approval, 831
 Master polling architecture, 703
 Math, 39, 229, 230
 MAX (get maximum), 234
 MAX_LEN (maximum length of a character string), 306
 Maximum message length, 681
 Maximum Web server connections, 664
 MB_CLIENT (communicate via PROFINET as Modbus TCP client), 730
 MB_COMM_LOAD (configure port on the PtP module for Modbus RTU), 747
 MB_MASTER (communicate via the PtP port as Modbus master), 749
 MB_SERVER (communicate via PROFINET as Modbus TCP server), 736
 MB_SLAVE (communicate via the PtP port as Modbus slave), 755
 MC_ChangeDynamic (change dynamic settings for the axis), 476
 MC_CommandTable, 473
 MC_Halt (pause axis), 462
 MC_Home (home axis), 460
 MC_MoveAbsolute (position axis absolutely), 464
 MC_MoveJog (move axis in jog mode), 471
 MC_MoveRelative (position axis relatively), 466
 MC_MoveVelocity (move axis at predefined velocity), 468
 MC_Power (release/block axis), 456
 MC_ReadParam (read parameters of a technology object), 480
 MC_Reset (confirm error), 459
 MC_WriteParam (read parameters of a technology object), 478
 Memory

- clock memory, 101
- I (process image input), 107
- L (local memory), 105
- load memory, 99
- M (bit memory), 108
- monitoring memory usage, 792
- peripheral input addresses (force table), 801
- Q (process image output), 107
- retentive memory, 99
- system memory, 101
- Temp memory, 108
- work memory, 99
- Memory areas
 - addressing Boolean or bit values, 106
 - immediate access, 105
 - process image, 105
- Memory card, 978
 - configure the startup parameters, 127
 - empty transfer card for a lost password, 136
 - firmware update, 133
 - incompatibility error, 784
 - inserting into CPU, 125
 - lost password, 136
 - operation, 124
 - overview, 124
 - program card, 131
 - transfer card, 128
- Memory locations, 105, 106
- Message
 - end, 679
 - length, 681
 - start, 677
- Message configuration
 - instructions, 702
 - receive, 676
 - transmit, 675, 675
- MicroMaster drive
 - connecting, 724
- MID (read the middle characters of a character string), 308
- MIN (get minimum), 234
- Miscellaneous PtP parameter errors, 685
- Mobile devices
 - Web page layout, 610
- MOD (return remainder of division), 231
- Modbus
 - function codes, 727
 - MB_CLIENT (communicate via PROFINET as Modbus TCP client), 730
 - MB_COMM_LOAD (configure port on the PtP module for Modbus RTU), 747
 - MB_MASTER (communicate via the PtP port as Modbus master), 749
 - MB_SERVER (communicate via PROFINET as Modbus TCP server), 736
 - MB_SLAVE (communicate via the PtP port as Modbus slave), 755
 - memory addresses, 728
 - Modbus slave example, 764
 - network station addresses, 728
 - RTU communication, 728
 - versions, 42, 746
- Modifying
 - program editor status, 797
 - variables from Web server, 620
 - watch table, 798
- Module information standard Web page, 616
- Modules
 - communication boards (CB), 29
 - communication module (CM), 29
 - communication processor (CP), 29
 - comparison chart, 26
 - configuring parameters, 147
 - signal board (SB), 29
 - signal modules (SM), 29
 - thermal zone, 50, 54
- ModuleStates, 353
- Monitor
 - capturing values of a DB, 797
 - resetting the start values of a DB, 797
- Monitoring
 - cycle time, 792
 - force operation, 802
 - force table, 801
 - LAD status, 796, 797
 - memory usage, 792
 - watch table, 796, 798
- Monitoring the program, 199
- Monitoring variables from Web server, 620
- Motion control
 - configuring the axis, 449
 - hardware and software limit switches, 483
 - homing (sequence for active homing), 490
 - homing configuration parameters, 488
 - homing the axis, 486
 - MC_ChangeDynamic (change dynamic settings for the axis), 476
 - MC_CommandTable, 473
 - MC_Halt (pause axis), 462
 - MC_Home (home axis), 460
 - MC_MoveAbsolute (position axis absolutely), 464
 - MC_MoveJog (move axis in jog mode), 471
 - MC_MoveRelative (position axis relatively), 466

MC_MoveVelocity (move axis at predefined velocity), 468
MC_Power (release/block axis), 456
MC_ReadParam (read parameters of a technology object), 480
MC_Reset (confirm error), 459
MC_WriteParam (read parameters of a technology object), 478
overview, 441
Motion control instructions, 455
Mounting
airflow, 50
clearance, 50
communication board (CB), 58
communication module (CM), 62
cooling, 50
CPU, 56
dimensions, 54
expansion cable, 64
grounding, 72
guidelines, 49
inductive loads, 74
isolation, 71
lamp loads, 73
overview, 55
signal board (SB), 58
signal module (SM), 60
terminal block connector, 63
thermal zone, 50, 54
wiring guidelines, 70, 72
MOVE (move value), 238
MOVE_BLK (move block), 238
Movement sequence (MC_CommandTable), 473
MRES
operator panel, 44
MUL (multiply), 230
Multi-node connections
connection types, 591
Ethernet protocols, 591
Multiple AWP variable definitions, 638
MUX (multiplex), 278
My Documentation Manager, 4

N

N (scan operand for negative signal edge), 209
N_TRIG (scan RLO for negative signal edge), 210
N= box and N coil (set operand on negative signal edge), 209
NEG (create twos complement), 232
Nesting depth, 77
Network communication, 550

bias and terminate cable, 670
Network connection
configuration, 149
multiple CPUs, 553, 554, 558, 573, 578
Network time protocol (NTP), 165
No restart, 81
NORM_X (normalize), 251
Normalizing analog values, 253
NOT_OK (check invalidity), 228
Numbers
binary, 111
integer, 112
real, 112

O

OB, (Organization block)
Off-delay (TOF), 212
OK (check validity), 228
On-delay delay (TON), 212
On-delay retentive (TONR), 212
Online
assigning an IP address, 158
capturing values of a DB, 797
comparing and synchronizing, 794
cycle time, 792
diagnostics buffer, 793
force, 801
force operation, 802
going online, 786
IP address, 789
memory usage, 792
monitor, 796
operating panel, 792
operator panel, 44
resetting the start values of a DB, 797
RUN/STOP buttons, 44
status, 796, 797
time of day, 789
tools, 795
watch table, 796, 797, 798
Online and diagnostic tools
downloading in RUN mode, 803
Online device names
PROFINET IO, 787
OPC, configuration, 771
Open User Communication
establishing a connection and reading data with TRCV_C, 520
establishing a connection and sending data with TSEND_C, 520

- Open User Communication instructions return values, 549
 - Operating mode, 44
 - changing STOP/RUN, 792
 - operating modes of the CPU, 81
 - Operator panel, 44
 - operating modes of the CPU, 81
 - Operator panels, 32
 - Optimized data blocks, 177
 - OR (logic operation), 275
 - Order numbers
 - communication interfaces (CM, CB and CP), 991
 - connector blocks, 993
 - connectors and terminal connections, 991
 - CPUs, 989
 - CSM 1277 Ethernet switch, 992
 - documentation, 994
 - end retainer, 993
 - expansion cables, 993
 - HMI basic panels, 992
 - memory cards, 992
 - PM 1207 power supply, 992
 - programming software, 994
 - signal boards, battery boards, 990
 - signal modules, 989
 - simulators, 993
 - STEP 7, 994
 - visualization software, 994
 - WinCC, 994
 - Organization block
 - call, 85
 - calling code blocks within the user program, 172
 - configuring operation, 174
 - creating, 174
 - function, 85
 - know-how protection, 193
 - linear and structured programming, 170
 - multiple cyclic, 174
 - overview, 77
 - priority classes, 85
 - processing, 172
 - startup processing, 84
 - OUT_Range (value outside range), 227
 - Output parameters, 175
 - configuring pulse channels, 367
 - pulse outputs, 365
- P**
- P (scan operand for positive signal edge), 209
 - P_TRIG (scan RLO for positive signal edge), 210
 - P= box and P coil (set operand on positive signal edge), 209
 - Panels (HMI), 32
 - Parameter assignment, 175
 - Parameters configuration
 - LENGH and BUFFER for SEND_PTP, 696
 - receive, 557
 - transmit, 556
 - Parity, 673
 - Passive/active communication
 - configuring the partners, 150, 593
 - connection IDs, 514
 - parameters, 153
 - Password protection
 - access to the CPU, 190
 - binding to a CPU or memory card, 195
 - code block, 193
 - copy protection, 195
 - CPU, 190
 - empty transfer card, 136
 - ENDIS_PW (enable/disable passwords), 259
 - lost password, 136
 - PID
 - overview, 419
 - PID_3STEP (PID controller with tuning for valves), 428
 - PID_3Step algorithm, 419
 - PID_Compact (universal PID controller with integrated tuning), 422
 - PID_Compact algorithm, 419
 - PLC
 - add modules, 141
 - assigning an IP address to an online CPU, 158
 - communication load, 98
 - comparing and synchronizing, 794
 - copying blocks from an online CPU, 197
 - cycle time, 97, 98
 - cycle time, 97, 98
 - device configuration, 137
 - download, 196
 - expansion cable, 64
 - force, 801
 - force operation, 802
 - HSC configuration, 418
 - installation, 55, 56
 - know-how protection, 193
 - memory card, 124
 - monitoring, 796
 - operating modes, 81
 - overview of the CPU, 23
 - power budget, 51
 - RTM (runtime meters), 291

- startup processing, 84
- system design, 169
- tags, 105
- terminal block connector, 63
- time synchronization property, 165
- using blocks, 170
- watch table, 798
- PM 1207 power module, 982
- Podcasts, 4
- Pointer
 - pointer overview, 118
- Pointers
 - Any data type, 119
 - Pointer data type, 118
 - Variant data type, 120
- Point-to-Point communication, 671
- Point-to-Point programming, 702
- Polling architecture, 703
- Port configuration, 672
 - errors, 687
 - instructions, 702
 - PtP example program, 705
- Port number, 517
- Port numbers
 - restricted, 549
- PORT_CFG (configure communication parameters dynamically), 686
- Portal view, 37
- Potentiometer module
 - specifications, 980
- Power budget, 51
 - example, 986
 - form for calculations, 987
 - overview, 985
- Power requirements
 - calculating a power budget, 986
 - form for calculations, 987
 - power budget, 985
- Power supply module
 - PM1207, 982
- Priority
 - priority class, 85
 - priority in processing, 94
- Process image
 - force, 801
 - force operation, 802
 - monitor, 796, 797
 - status, 796, 797, 801
- PROFIBUS
 - add CM 1243-5 (DP master) module, 572
 - add DP slave, 572
 - address, 574
 - address, configuring, 574
 - CM 1242-5 (DP slave) module, 570
 - CM 1243-5 (DP master) module, 570
 - distributed I/O instructions, 314
 - DPNRM_DG (read diagnostic data from a DP slave), 328
 - DPRD_DAT (read consistent data of a DP standard slave), 326
 - DPWR_DAT (write consistent data of a DP standard slave), 326
 - GET (read data from a remote CPU), 587
 - master, 569
 - network connection, 149, 573
 - PROFIBUS address, 574
 - PROFIBUS address properties, 574
 - PUT (write data to a remote CPU), 587
 - RALRM (receive interrupt), 318
 - RDREC (read data record), 315
 - S7 connection, 591
 - slave, 569
 - WRREC (write data record), 315
- PROFIBUS address, 574
- Profile OB, 94
- PROFINET
 - ad hoc mode, 518
 - configuring communication between CPU and HMI device, 552
 - configuring the IP address, 142
 - connection IDs, 514
 - CPU-to-CPU communication, 553
 - device naming and addressing, 166
 - distributed I/O instructions, 314
 - DPRD_DAT (read consistent data of a standard DP slave), 326
 - DPWR_DAT (write consistent data of a DP standard slave), 326
 - Ethernet address properties, 160
 - GET (read data from a remote CPU), 587
 - IP address, 159
 - IP address assignment, 167
 - MAC address, 159
 - network connection, 149, 553, 554, 558
 - number of communication connections, 511
 - overview, 517
 - PLC-to-PLC communication, 553
 - PUT (write data to a remote CPU), 587
 - RALRM (receive interrupt), 318
 - RDREC (read data record), 315
 - S7 connection, 591
 - system start-up time, 166
 - testing a network, 162
 - time synchronization, 142

- time synchronization property, 165
- types of communication, 509
- WRREC (write data record), 315
- PROFINET instructions
 - T_CONFIG (configure interface), 541
 - TCON (establish communication connection), 527
 - TDISCON (terminate communication connection), 527
 - TRCV (receive data via communication connection), 527
 - TRCV_C, 556
 - TRCV_C (receive data via Ethernet (TCP)), 520
 - TSEND (send data via communication connection), 527
 - TSEND_C (send data via Ethernet (TCP)), 520
 - TURCV (receive data via Ethernet (UDP)), 535
 - TUSEND (send data via Ethernet (UDP)), 535
- PROFINET IO
 - Adding a device, 558
 - Assigning a CPU, 559
 - Assigning device names, 559
 - Assigning device names online, 787
 - Device names, 559
 - Devices, 558
 - Online device names, 787
- PROFINET RT, 517
- Program
 - binding to a CPU or memory card, 195
 - calling code blocks within the user program, 172
 - capturing values of a DB, 797
 - copying blocks from an online CPU, 197
 - download, 196
 - linear and structured programs, 170
 - memory card, 124
 - organization blocks (OBs), 172
 - password protection, 193
 - priority class, 85
 - resetting the start values of a DB, 797
- Program card
 - configure the startup parameters, 127
 - creating, 131
 - inserting into CPU, 125
 - operation, 124
 - overview, 124
- Program control (SCL), 267
 - CASE, 269
 - CONTINUE, 273
 - EXIT, 273
 - FOR, 270
 - GO TO, 274
 - IF-THEN, 268
 - REPEAT, 272
 - RETURN, 274
 - WHILE, 271
- Program cycle OB, 86
- Program editor
 - capturing values of a DB, 797
 - monitor, 797
 - resetting the start values of a DB, 797
 - status, 797
- Program execution, 77
- Program information
 - In the call structure, 201
- Program structure, 172
 - calling code blocks, 172
- Programming
 - adding inputs or outputs to LAD or FBD instructions, 41
 - binding to a CPU or memory card, 195
 - block calls, 77
 - calling code blocks within the user program, 172
 - comparing and synchronizing code blocks, 794
 - data block (DB), 77
 - drag and drop between editors, 43
 - expandable instructions, 42
 - favorites, 38
 - FBD (function block diagram), 181
 - function (FC), 174
 - function block (FB), 77, 175
 - initial value of an FB, 175
 - inserting instructions, 38
 - instance data block (DB), 175
 - LAD (ladder), 180
 - linear program, 170
 - operating modes of the CPU, 81
 - PID overview, 419
 - PID_3STEP (PID controller with tuning for valves), 428
 - PID_3Step algorithm, 419
 - PID_Compact (universal PID controller with integrated tuning), 422
 - PID_Compact algorithm, 419
 - power flow (EN and ENO), 188
 - priority class, 85
 - PtP instructions, 702
 - RTM (runtime meters), 291
 - SCL (Structured Control Language), 181, 183
 - structured program, 170
 - system time, 287
 - types of code blocks, 77
 - unplugged modules, 47
 - unspecific CPU, 140
 - valid FC, FB, and DB numbers, 77

Programming user-defined Web page language switch, 657

Project

- access protection, 190
- binding to a CPU or memory card, 195
- comparing and synchronizing, 794
- download, 196
- empty transfer card, 136
- lost password, 136
- program card, 131
- protecting a code block, 193
- restricting access to a CPU, 190
- transfer card, 128

Project view, 37

Protection class, 834

Protection level

- binding to a CPU or memory card, 195
- code block, 193
- CPU, 190
- lost password, 136

Protocol

- communication, 671
- freeport, 671
- ISO on TCP, 517
- Modbus, 671
- PROFINET RT, 517
- TCP, 517
- UDP, 517
- USS, 671

PTO (pulse train output)

- cannot be forced, 802
- configuring pulse channels, 367
- CTRL_PWM (pulse width modulation), 364
- operation, 365

PtP communication, 671

- configuring parameters, 675
- configuring ports, 672
- example program, 704
- example program configuration, 705
- example program, running, 712
- example program, STEP 7 programming, 710
- programming, 702
- terminal emulator for example program, 711

PtP error classes, 685

PtP instruction return values, 684

Pull or plug of modules OB, 91

Pulse catch, 146, 147

Pulse catch bits, digital input configuration, 146

Pulse delay (TP), 212

Pulse outputs, 365

PUT

- configuring the connection, 151

PUT (write data to a remote CPU), 587

PWM (pulse width modulation)

- cannot be forced, 802
- configuring pulse channels, 367
- CTRL_PWM (pulse width modulation), 364
- operation, 365

Q

Q memory

- configuring pulse channels, 367
- pulse outputs, 365

QRY_CINT (query cyclic interrupt parameters), 336

QRY_DINT (query time-delay interrupt status), 342

QRY_TINT (query status of time of day interrupt), 340

Queuing, 94

Quotation mark conventions, Web server, 639

R

R (reset output), 206

R_TRIG (set tag on positive signal edge), 210

Rack or station failure OB, 92

RALRM, 322

RALRM (receive interrupt), 318

Rated voltages, 834, 834

RCV_CFG (configure serial receive parameters dynamically), 689

RCV_PTP (enable receive messages), 697

RCV_RST (delete receive buffer), 698

RD_ADDR (determine the IO addresses from the hardware identifier), 406

RD_LOC_T (read local time), 287

RD_SYS_T (read time-of-day), 287

RDREC, 322

RDREC (read data record), 315

RE_TRIGR (restart cycle monitoring time), 262

READ_DBL (read from data block in load memory), 401

Reading HTTP variables, 631

Receive configuration errors, 693

Receive message configuration, 676

- PtP example program, 706

Receive parameters configuration, 557

Receive runtime return values, 697

Recipe

- DB structure, 370
- example program, 378
- overview, 369
- RecipeExport (recipe export), 374
- RecipeImport (recipe import), 376

- Referencing enum types, user-defined Web pages, 635
- Refreshing user-defined Web pages, 627
- Relay electrical service life, 835
- REPLACE (replace characters in a character string), 312
- Replacing modules, 47
- Requirements, installation, 36
- Reset timer (RT), 212
- Reset to factory settings, 789
- RESET_BF (reset bit field), 207
- Resetting the start values of a DB, 797
- Restricted TSAPs and port numbers, 549
- RET (return), 258
- Retentive block tags
 - download in RUN mode, 809
- Retentive memory, 24, 99
 - CPU 1211C, 837
 - CPU 1212C, 847
 - CPU 1214C, 857
 - CPU 1215C, 867
 - CPU 1217C, 879
- Return values
 - Open User Communication instructions, 549
 - PtP instructions, 684
- Reverse voltage protection, 835
- RIGHT (read the right characters of a character string), 308
- ROL (rotate left) and ROR (rotate right), 282
- ROUND (round numerical value), 249
- Router IP address, 160
- RS (reset/set flip-flop), 207
- RS232 and RS485 communication modules, 669
- RS485 connector
 - termination and bias, 670
- RT (reset timer), 212
- RTS, 674
- RTS always on, 674
- RTS Off delay, 676
- RTS On delay, 676
- RTS switched, 674
- Run axis commands as movement sequence (MC_CommandTable), 473
- RUN mode, 81, 85, 792
 - force operation, 802
 - operator panel, 44
 - toolbar buttons, 44
- RUN to STOP transition, 104
- RUN/STOP buttons, 44
- Runtime meters (RTM), 291
- S**
- S (set output), 206
- S_CONV (convert character string), 293
- S_MOV (move character string), 293
- S7 communication
 - configuring the connection, 151
- S7-1200
 - access protection, 190
 - add modules, 141
 - add new device, 138
 - airflow, 50
 - AS-i, 579
 - AS-i address, 579
 - AS-i port, 578
 - capturing values of a DB, 797
 - clearance, 50
 - communication load, 98
 - compare code blocks, 794
 - comparison chart of CPU models, 24
 - configuring the CPU parameters, 142
 - configuring the modules, 147
 - cooling, 50
 - CPU installation, 56
 - cycle time, 98
 - device configuration, 137
 - empty transfer card for a lost password, 136
 - Ethernet port, 159
 - expansion cable, 64
 - force, 801
 - force operation, 802
 - grounding, 72
 - HSC configuration, 418
 - inductive loads, 74
 - installation, 55
 - installing a CB, 58
 - installing a CM, 62
 - installing an SB, 58
 - installing an SM, 60
 - IP address, 159
 - isolation guidelines, 71
 - know-how protection, 193
 - lamp loads, 73
 - lost password, 136
 - MAC address, 159
 - modules, 26
 - monitoring, 796
 - mounting dimensions, 54
 - network connection, 149
 - operating modes, 81
 - operation, 798
 - operator panel, 44
 - overview of the CPU, 23

- password protection, 190
- power budget, 51
- PROFIBUS, 574
- PROFIBUS address, 574
- PROFINET, 159
- program card, 131
- pulse outputs, 365
- resetting the start values of a DB, 797
- RUN/STOP buttons, 44
- startup parameters, 127
- startup processing, 84
- terminal block connector, 63
- thermal zone, 50, 54
- TS Adapter, 26
- wiring guidelines, 70, 72
- SCALE_X (scale), 251
- Scaling analog values, 253
- Scaling analogs, 39
- Scan cycle
 - force, 801
 - force operation, 802
 - overview, 97
- SCL (Structured Control Language)
 - ABS (form absolute value), 233
 - ACOS (form arccosine value), 236
 - ACT_TINT (activate time of day interrupt), 339
 - ADD (add), 230
 - addressing, 183
 - AND (logic operation), 275
 - ASIN (form arcsine value), 236
 - ATAN (form arctangent value), 236
 - ATH (convert ASCII string to hexadecimal number), 304
 - ATTACH (attach an OB to an interrupt event), 331
 - bit logic, 203
 - calling an FB or FC, 183
 - calling blocks, 172
 - CAN_DINT (cancel time-delay interrupt), 342
 - CAN_TINT (cancel time of day interrupt), 339
 - CASE, 269
 - CEIL (generate next higher integer from floating-point number), 250
 - Chars_TO_Strg (convert array of CHAR to character string), 302
 - compare values, 226
 - CONCAT (combine character strings), 307
 - conditions, 183
 - CONTINUE, 273
 - control statements, 183, 267, 268, 269, 270, 271, 272, 273, 274
 - CONV (convert value), 245
 - Conversion instructions, 245
 - COS (form cosine value), 236
 - CTD (count down), 220
 - CTRL_HSC (control highspeed counter), 409
 - CTRL_PWM (pulse width modulation), 364
 - CTU (count up), 220
 - CTUD (count up and down), 220
 - DataLogClose (close data log), 389
 - DataLogCreate (create data log), 382
 - DataLogNewFile (data log in new file), 390
 - DataLogOpen (open data log), 385
 - DataLogWrite (write data log), 387
 - DEC (decrement), 232
 - DECO (decode), 276
 - DELETE (delete characters in a character string), 310
 - DETACH (detach an OB from an interrupt event), 331
 - DeviceStates (read module status of an I/O system), 347
 - DIS_AIRT (disable execution of higher priority interrupts and asynchronous error events), 344
 - DIV (divide), 230
 - EN and ENO (power flow), 188
 - EN_AIRT (enable execution of higher priority interrupts and asynchronous error events), 344
 - ENCO (encode), 276
 - EXIT, 273
 - EXP (form exponential value), 236
 - expressions, 183
 - EXPT (exponentiate), 236
 - F_TRIG (set tag on negative signal edge), 210
 - FILL_BLK (fill block), 242
 - FIND (find characters in a character string), 313
 - FLOOR (generate next lower integer from floating-point number), 250
 - FOR, 270
 - FRAC (return fraction), 236
 - GET (read data from a remote CPU), 587
 - GET_DIAG (read diagnostic information), 358
 - GOTO, 274
 - HTA (convert hexadecimal number to ASCII string), 304
 - IF-THEN, 268
 - IN_Range (value within range), 227
 - INC (increment), 232
 - INSERT (insert characters in a character string), 311
 - INV (create ones complement), 276
 - JMP_LIST (define jump list), 255
 - LED (read LED status), 346
 - LEFT (read the left characters of a character string), 308

- LEN (determine the length of a character string), 307
- LIMIT (set limit value), 235
- LN (form natural logarithm), 236
- LOG2GEO (Determine the slot from the hardware identifier), 404
- MAX (get maximum), 234
- MAX_LEN (maximum length of a character string), 306
- MB_CLIENT (communicate via PROFINET as Modbus TCP client), 730
- MB_COMM_LOAD (configure port on the PtP module for Modbus RTU), 747
- MB_MASTER (communicate via the PtP port as Modbus master), 749
- MB_SERVER (communicate via PROFINET as Modbus TCP server), 736
- MB_SLAVE (communicate via the PtP port as Modbus slave), 755
- MC_ChangeDynamic (change dynamic settings for the axis), 476
- MC_CommandTable, 473
- MC_Halt (pause axis), 462
- MC_Home (home axis), 460
- MC_MoveAbsolute (position axis absolutely), 464
- MC_MoveJog (move axis in jog mode), 471
- MC_MoveRelative (position axis relatively), 466
- MC_MoveVelocity (move axis at predefined velocity), 468
- MC_Power (release/block axis), 456
- MC_ReadParam (read parameters of a technology object), 480
- MC_Reset (confirm error), 459
- MC_WriteParam (read parameters of a technology object), 478
- MID (read the middle characters of a character string), 308
- MIN (get minimum), 234
- MOD (return remainder of division), 231
- ModuleStates (read module status information of a module), 353
- MOVE (move value), 238
- MOVE_BLK (move block), 238
- MUL (multiply), 230
- MUX (multiplex), 278
- NEG (create twos complement), 232
- NORM_X (normalize), 251
- NOT_OK (check invalidity), 228
- OK (check validity), 228
- operators, 183
- OR (logic operation), 275
- OUT_Range (value outside range), 227
- overview, 181
- PID overview, 419
- PID_3STEP (PID controller with tuning for valves), 428
- PID_3Step algorithm, 419
- PID_Compact (universal PID controller with integrated tuning), 422
- PID_Compact algorithm, 419
- PORT_CFG (configure communication parameters dynamically), 686
- priority of operators, 183
- program control, 267
- program editor, 181
- PUT (write data to a remote CPU), 587
- QRY_CINT (query cyclic interrupt parameters), 336
- QRY_DINT (query time-delay interrupt status), 342
- QRY_TINT (query status of time of day interrupt), 340
- R_TRIG (set tag on positive signal edge), 210
- RCV_CFG (configure serial receive parameters dynamically), 689
- RCV_PTP (enable receive messages), 697
- RCV_RST (delete receive buffer), 698
- RD_ADDR (determine the IO addresses from the hardware identifier), 406
- RD_LOC_T (read local time), 287
- RD_SYS_T (read time-of-day), 287
- READ_DBL (read from data block in load memory), 401
- RecipeExport (recipe export), 374
- RecipeImport (recipe import), 376
- REPEAT, 272
- REPLACE (replace characters in a character string), 312
- RETURN, 274
- RIGHT (read the right characters of a character string), 308
- ROL (rotate left) and ROR (rotate right), 282
- ROUND (round numerical value), 249
- RTM (runtime meters), 291
- S_CONV (convert character string), 293
- S_MOV (move character string), 293
- SCALE_X (scale), 251
- SEL (select), 278
- SEND_CFG (configure serial transmission parameters dynamically), 688
- SEND_PTP (transmit send buffer data), 694
- SET_CINT (set cyclic interrupt parameters), 334
- SET_TIMEZONE (set time zone), 290
- SET_TINTL (set date and time of day interrupt), 337
- SGN_GET (Query RS232 signals), 699
- SGN_SET (set RS-232 signals), 700

- SHL (shift left) and SHR (shift right), 281
- SIN (form sine value), 236
- SQR (form square), 236
- SQRT (form square root), 236
- SRT_DINT (start time-delay interrupt), 342
- Strg_TO_Chars (convert character string to array of CHAR), 302
- STRG_VAL (convert character string to numerical value), 293
- SUB (subtract), 230
- SWAP (swap bytes), 243
- SWITCH (jump distributor), 256
- T_ADD (add times), 284
- T_COMBINE (combine times), 285
- T_CONV (convert times and extract), 283
- T_DIFF (time difference), 285
- T_SUB (subtract times), 284
- TAN (form tangent value), 236
- timers, 212
- TM_MAIL (send email), 775
- TRUNC (truncate numerical value), 249
- UFILL_BLK (fill block uninterruptible), 242
- UMOVE_BLK (move block uninterruptible), 238
- USS_DRV (Swap data with drive), 716
- USS_PORT (Edit communication via USS network), 715
- USS_RPM (readout parameters from the drive), 719
- USS_WPM (change parameters in the drive), 720
- VAL_STRG (convert numerical value to character string), 293
- Var section, 181
- WHILE, 271
- WR_LOC_T (set local time), 287
- WR_SYS_T (set time-of-day), 287
- WRIT_DBL (write to data block in load memory), 401
- WWW (synchronizing user-defined Web pages), 642
- XOR (logic operation), 275
- Security
 - access protection, 190
 - binding to a CPU or memory card, 195
 - copy protection, 195
 - CPU, 190
 - know-how protection for a code block, 193
 - lost password, 136
- SEL (select), 278
- Send message configuration, 675, 675
- Send parameters configuration, 150, 556, 593
- SEND_CFG (configure serial transmission parameters dynamically), 688
- SEND_PTP (send Point-to-Point data)
 - LENGH and BUFFER parameters, 696
- SEND_PTP (transmit send buffer data), 694
- Serial communication, 671
- Service and support, 3
- SET_BF (set bit field), 207
- SET_CINT (set cyclic interrupt parameters), 334
- SET_TIMEZONE (set time zone), 290
- SET_TINTL (set date and time of day interrupt), 337
- Settings, 43
- SGN_GET (Query RS232 signals), 699
- SGN_SET (set RS-232 signals), 700
- SHL (shift left) and SHR (shift right), 281
- Siemens security certificate, Web pages, 613, 666
- Siemens technical support, 3
- siemens_automation_language cookie, 657
- Signal boards (SB)
 - add modules, 141
 - analog output representation (current), 918, 952
 - analog output representation (voltage), 917, 951
 - configuration of parameters, 147
 - input representation (current), 917, 951
 - input representation (voltage), 916, 950
 - installation, 58
 - overview, 29
 - power requirements, 985
 - removal, 58
 - SB 1221 DI 4 x 24 VDC, 200 kHz, 935
 - SB 1221 DI 4 x 5 VDC, 200 kHz, 935
 - SB 1222 DQ 4 x 24 VDC, 200 kHz, 937
 - SB 1222 DQ 4 x 5 VDC, 200 kHz, 937
 - SB 1223 DI 2 x 24 VDC, DQ 2 x 24 VDC, 943
 - SB 1223 DI 2 x 24 VDC/DQ 2 x 24 VDC, 200 kHz, 940
 - SB 1223 DI 2 x 5 VDC/DQ 2 x 5 VDC, 200 kHz, 940
 - SB 1231 AI 1 x 12 bit, 946
 - SB 1231 AI 1 x 16 bit RTD, 957
 - SB 1231 AI 1 x 16 bit Thermocouple, 953
 - SB 1232 AQ 1 x 12 bit, 948
- Signal handling errors, 700, 701
- Signal modules (SM)
 - add modules, 141
 - analog input representation (current), 917, 951
 - analog input representation (voltage), 916, 950
 - analog output representation (current), 918, 952
 - analog output representation (voltage), 917, 951
 - configuration of parameters, 147
 - expansion cable, 64
 - installation, 60
 - overview, 29
 - power requirements, 985
 - removal, 61
 - SM 1221 DI 16 x 24 VDC, 892

- SM 1221 DI 8 x 24 VDC, 892
- SM 1222 DQ 16 x 24 VDC, 895
- SM 1222 DQ 16 x Relay, 895
- SM 1222 DQ 8 Relay Changeover, 894
- SM 1222 DQ 8 x 24 VDC, 894
- SM 1222 DQ 8 x Relay, 894
- SM 1223 DI 16 x 24 VDC, DQ 16 x 24 VDC, 900
- SM 1223 DI 16 x 24 VDC, DQ 16 x Relay, 900
- SM 1223 DI 8 x 120/230 VAC/DQ 8 x Relay, 904
- SM 1223 DI 8 x 24 VDC, DQ 8 x 24 VDC, 900
- SM 1223 DI 8 x 24 VDC, DQ 8 x Relay, 900
- SM 1231 AI 4 x 13 bit, 907
- SM 1231 AI 4 x 16 bit, 907
- SM 1231 AI 4 x 16 bit TC, 919
- SM 1231 AI 4 x RTD x 16 bit, 925
- SM 1231 AI 8 x 13 bit, 907
- SM 1231 AI 8 x 16 bit TC, 919
- SM 1231 AI 8 x RTD x 16 bit, 925
- SM 1232 AQ 2 x 14 bit, 910
- SM 1232 AQ 4 x 14 bit, 910
- SM 1234 AI 4 x 13 bit/AQ 2 x 14 bit, 913
- SM 1278 4xIO-Link Master, 931
- step response times, 916
- Simulators, 978
- SIN (form sine value), 236
- Slave polling architecture, 703
- SM 1231 RTD
 - selection tables, 928, 960
- SM and SB
 - comparison chart, 26
 - device configuration, 137
- SMS, 770
- Snubber circuits for inductive loads, 74
- Software flow control, 675
- Special characters
 - User-defined Web pages, 639
- Specifications
 - analog input representation (current), 917, 951
 - analog input representation (voltage), 916, 950
 - analog output representation (current), 918, 952
 - analog output representation (voltage), 917, 951
 - approvals, 829
 - BB 1297, 962
 - CB 1241 RS485, 974
 - CM 1241 RS232, 975
 - CM 1241 RS422/485, 976
 - CPU 1211C AC/DC/Relay, 837
 - CPU 1211C DC/DC/DC, 837
 - CPU 1211C DC/DC/Relay, 837
 - CPU 1212C AC/DC/Relay, 847
 - CPU 1212C DC/DC/DC, 847
 - CPU 1212C DC/DC/Relay, 847
 - CPU 1214C AC/DC/Relay, 857
 - CPU 1214C DC/DC/DC, 857
 - CPU 1214C DC/DC/Relay, 857
 - CPU 1215C AC/DC/Relay, 867
 - CPU 1215C DC/DC/DC, 867
 - CPU 1215C DC/DC/Relay, 867
 - CPU 1217C DC/DC/DC, 879
 - electromagnetic compatibility (EMC), 832
 - environmental conditions, 833
 - general technical specifications, 829
 - industrial environments, 831
 - input simulators, 978
 - memory cards, 978
 - potentiometer module, 980
 - rated voltages, 834
 - SB 1221 DI 4 x 24 VDC, 200 kHz, 935
 - SB 1221 DI 4 x 5 VDC, 200 kHz, 935
 - SB 1222 DQ 4 x 24 VDC, 200 kHz, 937
 - SB 1222 DQ 4 x 5 VDC, 200 kHz, 937
 - SB 1223 DI 2 x 24 VDC, DQ 2 x 24 VDC, 943
 - SB 1223 DI 2 x 24 VDC/DQ 2 x 24 VDC, 200 kHz, 940
 - SB 1223 DI 2 x 5 VDC/DQ 2 x 5 VDC, 200 kHz, 940
 - SB 1231 AI 1 x 12 bit, 946
 - SB 1231 AI 1 x 16 bit RTD, 957
 - SB 1231 AI 1 x 16 bit Thermocouple, 953
 - SB 1232 AQ 1 x 12 bit, 948
 - SM 1221 DI 16 x 24 VDC, 892
 - SM 1221 DI 8 x 24 VDC, 892
 - SM 1222 DQ 16 x 24 VDC, 895
 - SM 1222 DQ 16 x Relay, 895
 - SM 1222 DQ 8 Relay Changeover, 894
 - SM 1222 DQ 8 x 24 VDC, 894
 - SM 1222 DQ 8 x Relay, 894
 - SM 1223 DI 16 x 24 VDC, DQ 16 x 24 VDC, 900
 - SM 1223 DI 16 x 24 VDC, DQ 16 x Relay, 900
 - SM 1223 DI 8 x 24 VDC, DQ 8 x Relay, 900
 - SM 1223 DI 8 x 120/230 VAC/DQ 8 x Relay, 904
 - SM 1223 DI 8 x 24 VDC, DQ 8 x 24 VDC, 900
 - SM 1231 AI 4 x 13 bit, 907
 - SM 1231 AI 4 x 16 bit, 907
 - SM 1231 AI 4 x 16 bit TC, 919
 - SM 1231 AI 4 x RTD x 16 bit signal module, 925
 - SM 1231 AI 8 x 13 bit, 907
 - SM 1231 AI 8 x 16 bit TC, 919
 - SM 1231 AI 8 x RTD x 16 bit signal module, 925
 - SM 1232 AQ 2 x 14 bit, 910
 - SM 1232 AQ 4 x 14 bit, 910
 - SM 1234 AI 4 x 13 bit/AQ 2 x 14 bit, 913
 - SM 1278 4xIO-Link Master, 931
 - step response times (CPU), 842, 852, 862, 873, 888

- step response times (SB), 950
- step response times (SM), 916
- SQR (form square), 236
- SQRT (form square root), 236
- SR (set/reset flip-flop), 207
- SRT_DINT (start time-delay interrupt), 342
- Standard data blocks, 177
- Standard Web pages, 601
 - accessing from PC, 606
 - changing operating mode, 614
 - communication, 620
 - cookie restrictions, 666
 - Data Logs, 623
 - Diagnostic, 616
 - Identification, 615
 - Intro, 613
 - JavaScript restrictions, 665
 - layout, 609
 - logging in and out, 611
 - Module information, 616
 - secure access, 607
 - Start, 614
 - Variable Status, 620
- Start conditions, 677
- Start message character, 677
- Start standard Web page, 614
- Startup after POWER ON, 81
 - startup processing, 84
- STARTUP mode
 - force operation, 802
- Startup OB, 86
- Startup parameters, 127
- Status
 - LED indicators, 783
 - LED indicators (communication interface), 669
- Status OB, 93
- STEP 7
 - add modules, 141
 - add new device, 138
 - Adding a PROFINET IO device, 558
 - adding inputs or outputs to a LAD or FBD instruction, 41
 - AS-i, 579
 - AS-i port, 578
 - assigning an IP address to an online CPU, 158
 - block calls, 77
 - calling code blocks within the user program, 172
 - capturing values of a DB, 797
 - changing the settings, 43
 - communication load, 98
 - comparing and synchronizing, 794
 - configuring the CPU, 142
 - configuring the modules, 147
 - copying blocks from an online CPU, 197
 - cycle time, 97, 98
 - cycle time, 97, 98
 - data block (DB), 77
 - device configuration, 137
 - download, 196
 - drag and drop between editors, 43
 - Ethernet port, 159
 - expandable inputs or outputs, 42
 - favorites, 38
 - force, 801
 - force operation, 802
 - function (FC), 174
 - function block (FB), 77, 175
 - HSC configuration, 418
 - initial value of an FB, 175
 - inserting instructions, 38
 - instance data block (DB), 175
 - linear and structured programs, 170
 - memory card, 124
 - monitoring, 796, 797
 - network connection, 149
 - operating modes, 81
 - operation, 798
 - operator panel, 44
 - password protection, 193
 - Portal view, 37
 - priority class (OB), 85
 - PROFIBUS, 574
 - PROFINET, 159
 - program card, 124
 - Project view, 37
 - resetting the start values of a DB, 797
 - RTM (run time meters), 291
 - RUN/STOP buttons, 44
 - startup processing, 84
 - time synchronization property (PROFINET), 165
 - types of code blocks, 77
 - unplugged modules, 47
 - valid FC, FB, and DB numbers, 77
- STEP 7 programming
 - PtP example program, 710
 - user-defined Web pages, 642
- STEP 7 web pages, 4
- Stop bits, 673
- STOP mode, 81, 792
 - enable outputs in STOP mode, 800
 - force operation, 802
 - operator panel, 44
 - toolbar buttons, 44
- STP (exit program), 263

- Strg_TO_Chars (convert character string to array of CHAR), 302
- STRG_VAL (convert character string to numerical value), 293
- String
- S_MOVE (move character string), 293
 - string data overview, 292
 - String data type, 115
 - string operations overview, 306
- Structured programming, 170, 172
- calling blocks, 172
- SUB (subtract), 230
- Subnet mask, 160
- Support, 3
- Suppressor circuits for inductive loads, 74
- Surge immunity, 832
- SWAP (swap bytes), 243
- SWITCH (jump distributor), 256
- Switching languages, user-defined Web pages, 656
- Synchronization
- time synchronization property (PROFINET), 165
- System clock
- RD_SYS_T (read time-of-day), 287
 - WR_LOC_T (set local time), 287
 - WR_SYS_T (set time-of-day), 287
- System memory byte, 102
- System requirements, 36
- T**
- T_ADD (add times), 284
- T_COMBINE (combine times), 285
- T_CONFIG (configure interface), 541
- T_CONV (convert times and extract), 283
- T_DIFF (time difference), 285
- T_SUB (subtract times), 284
- Tags
- force, 801
 - force operation, 802
 - monitor, 796
 - status, 796
- TAN (form tangent value), 236
- Task cards
- columns and headers, 42, 746
- TCON
- configuration, 150
 - connection IDs, 514
 - connection parameters, 153
- TCON (establish communication connection), 527
- TCON_Param, 153
- TCP
- ad hoc mode, 518
 - connection configuration, 150
 - connection IDs, 514
 - parameters, 153
 - protocol, 517
- TCP/IP communication, 517
- TDISCON (terminate communication connection), 527
- Technical specifications, 829
- Technical support, 3
- Technology instructions, 409
- Technology module
- SM 1278, 931
- Technology objects
- Motion control, 448
 - PID, 420
- Telecontrol, 767
- TeleService adapter and module, 66
- Teleservice communication
- TM_MAIL (send email), 775
- TeleService via GPRS, 767
- Terminal block connector, 63
- Terminal emulator for PtP example program, 711
- Testing the program, 199
- Thermal zone, 50, 54
- Thermocouple
- basic operation, 922, 955
 - cold junction compensation, 922, 955
 - SB 1231 AI 1 x 16 bit, 953
 - SB 1231 Filter selection table, 955
 - SB 1231 Thermocouple filter selection table, 955
 - SM 1231 Thermocouple filter selection table, 923
 - SM 1231 Thermocouple selection table, 923
- TIA Portal
- Portal view, 37
 - Project view, 37
- Time
- DTL (date and time long data type), 114
 - RD_LOC_T (read local time), 287
 - RD_SYS_T (read time-of-day), 287
 - SET_TIMEZONE (set time zone), 290
 - T_ADD (add times), 284
 - T_COMBINE (combine times), 285
 - T_CONV (convert times and extract), 283
 - T_DIFF (time difference), 285
 - T_SUB (subtract times), 284
 - Time data type, 113
 - TOD (time of day data type), 113
 - WR_LOC_T (set local time), 287
 - WR_SYS_T (set time-of-day), 287
- Time delay OB, 87
- Time error interrupt OB, 88
- Time of day
- configuring the online CPU, 789

- Time of day OB, 93
 - Time synchronization property, 165
 - Time-delay interrupts, 342
 - Timers
 - operation, 215
 - quantity, 25, 839, 849, 859, 869, 881
 - RT (reset timer), 212
 - size, 25, 839, 849, 859, 869, 881
 - TOF (off-delay timer), 212
 - TON (on-delay delay timer), 212
 - TONR (on-delay retentive) timer, 212
 - TP (pulse delay timer), 212
 - TimeTransformationRule for daylight saving time, 289
 - TM_MAIL (send email), 775
 - Trace feature, 813
 - Transfer (program) cards, 978
 - Transfer card, 128
 - configure the startup parameters, 127
 - empty transfer card for a lost password, 136
 - inserting into CPU, 125
 - lost password, 136
 - operation, 124
 - overview, 124
 - Transmission block (T-block), 555
 - Transmit configuration errors, 689
 - Transmit message configuration, 675, 675
 - PtP example program, 705
 - Transmit runtime errors, 695
 - TRCV
 - ad hoc mode, 518
 - connection IDs, 514
 - TRCV (receive data via communication connection), 527
 - TRCV_C, 556
 - ad hoc mode, 518
 - configuration, 150
 - connection IDs, 514
 - connection parameters, 153
 - parameter configuration, 557
 - TRCV_C (receive data via Ethernet (TCP)), 520
 - Triggering values in the watch table, 799
 - Troubleshooting
 - diagnostics buffer, 793
 - LED indicators, 783
 - TRUNC (truncate numerical value), 249
 - TS Adapter, 26
 - installing a TS module, 66
 - installing on a DIN rail, 69
 - installing on a wall, 69
 - SIM card, 67
 - TSAP, 517
 - TSAP (transport service access points), 152, 519, 555, 592
 - TSAPs
 - restricted, 549
 - TSEND
 - connection IDs, 514
 - TSEND (send data via communication connection), 527
 - TSEND_C, 555
 - configuration, 150
 - connection IDs, 514
 - connection parameters, 153
 - TSEND_C (send data via Ethernet (TCP)), 520
 - TSEND_C instruction configuration, 556
 - TURCV
 - configuration, 150
 - connection parameters, 153
 - TURCV (receive data via Ethernet (UDP)), 535
 - TUSEND
 - configuration, 150
 - parameters, 153
 - TUSEND (send data via Ethernet (UDP)), 535
- ## U
- UDP
 - connection configuration, 150
 - parameters, 153
 - UDP protocol, 517
 - UFILL_BLK (fill block uninterruptible), 242
 - UMOVE_BLK (move block uninterruptible), 238
 - Unknown CPU version error, 784
 - Unplugged modules, 47
 - Unspecific CPU, 140
 - Update OB, 93
 - Updating firmware
 - from STEP 7, 791
 - from Web server, 619
 - Updating user-defined Web pages, 627
 - Uploading
 - copying blocks from an online CPU, 197
 - user program, 197
 - User interface
 - STEP 7 project and portal views, 37
 - User program
 - adding inputs or outputs to LAD or FBD instructions, 41
 - binding to a CPU or memory card, 195
 - calling code blocks within the user program, 172
 - copying blocks from an online CPU, 197
 - download, 196
 - drag and drop between editors, 43

- expandable instructions, 42
 - favorites, 38
 - inserting instructions, 38
 - linear and structured programs, 170
 - memory card, 124
 - organization blocks (OBs), 172
 - password protection, 193
 - program card, 124
 - transfer card, 124
 - User-defined Web pages, 602, 625
 - accessing from PC, 644
 - activating and deactivating from control DB, 660
 - AWP commands for accessing S7-1200 data, 627
 - configuring, 641
 - creating fragments, 637
 - creating with HTML editor, 626
 - deleting program blocks, 642
 - downloading corresponding DBs, 643
 - enabling with WWW instruction, 642
 - example, 645
 - generating program blocks, 642
 - handling special characters, 639
 - HTML listing, 650
 - importing fragments, 638
 - load memory constraints, 644
 - manual fragment DB control, 660
 - multiple language configuration, 659
 - multiple languages, 656
 - programming in STEP 7, 642
 - reading special variables, 631
 - reading variables, 629
 - refreshing, 627
 - writing special variables, 633
 - writing variables, 630
 - USS protocol library
 - general drive setup information, 724
 - overview, 712
 - requirements for using, 713
 - status codes, 722
 - USS_DRV (Swap data with drive), 716
 - USS_PORT (Edit communication via USS network), 715
 - USS_RPM (readout parameters from the drive), 719
 - USS_WPM (change parameters in the drive), 720
- V**
- VAL_STRG (convert numerical value to character string), 293
 - Valve PID tuning, 428
 - Variable index for an array, 241
 - Variable Status standard Web page, 620
 - Variables, monitoring and modifying from Web server, 620
 - Versions of instructions, 42, 746
 - Visualization
 - HMI devices, 32
- W**
- Wait time, 673
 - Warm restart, 81
 - Watch table
 - enable outputs in STOP mode, 800
 - force, 199
 - memory card, 124
 - monitor, 796
 - operation, 798
 - trigger values, 799
 - Watchdog timer (RE_TRIGR instruction), 262
 - Web pages
 - STEP 7 service, support, and documentation, 4
 - Web server, 601
 - appearance on mobile device, 610
 - constraints, 664
 - enabling, 603
 - maximum HTTP connections, 664
 - Quotation mark conventions, 639
 - standard Web pages, 606
 - update rate, 603
 - user-defined Web pages, 625
 - Wiring diagrams
 - CB 1241 RS 485, 974
 - CPU 1211C, 844
 - CPU 1212C, 854
 - CPU 1214C, 864
 - CPU 1215C, 875
 - CPU 1217C, 891
 - SB 1221, 936
 - SB 1222, 939
 - SB 1223, 942, 945
 - SB 1231, 947
 - SB 1231 RTD, 959
 - SB 1231 thermocouple, 956
 - SB 1232, 949
 - SM 1221, 893
 - SM 1222, 897
 - SM 1223, 902, 906
 - SM 1231, 908
 - SM 1231 RTD, 927
 - SM 1231 thermocouple, 921
 - SM 1232, 912
 - SM 1234, 915
 - SM 1278 IO-Link Master, 934

Wiring guidelines, 72
 clearance for airflow and cooling, 50
 grounding, 72
 prerequisites, 70
Work memory, 24
 CPU 1211C, 837
 CPU 1212C, 847
 CPU 1214C, 857
 CPU 1215C, 867
 CPU 1217C, 879
WR_LOC_T (set local time), 287
WR_SYS_T (set time-of-day), 287
WRIT_DBL (write to data block in load memory), 401
WRREC, 322
WRREC (write data record), 315
WWW (synchronizing user-defined Web pages), 642

X

x box (FBD exclusive OR logic operation), 203
XON / XOFF, 675
XOR (logic operation), 275