

PSpice Schematics

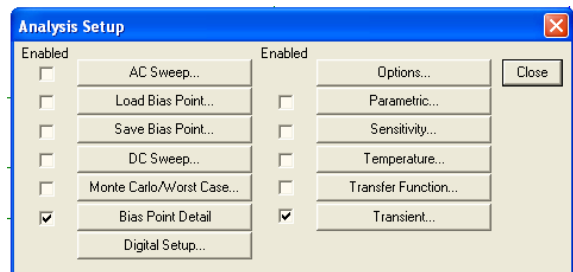

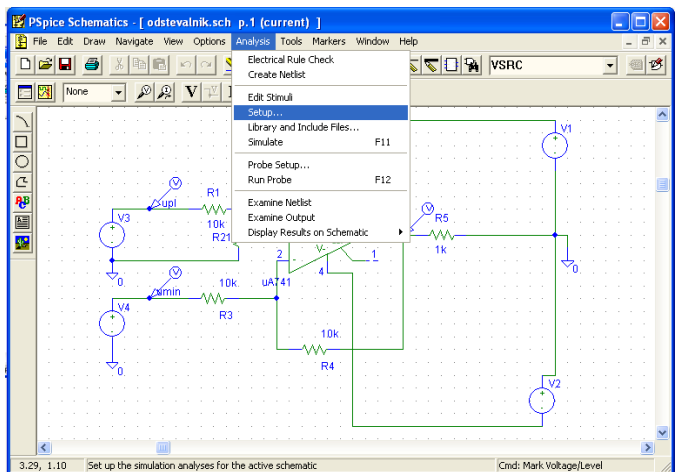

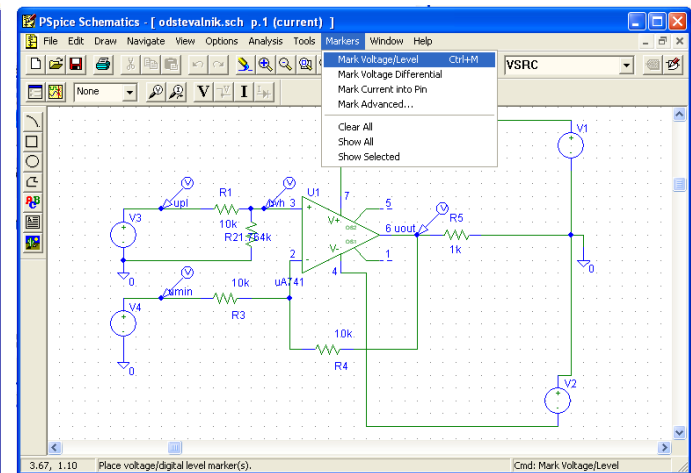
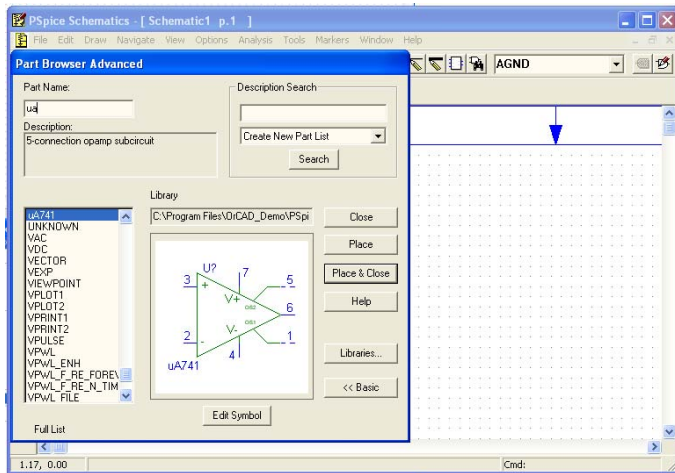
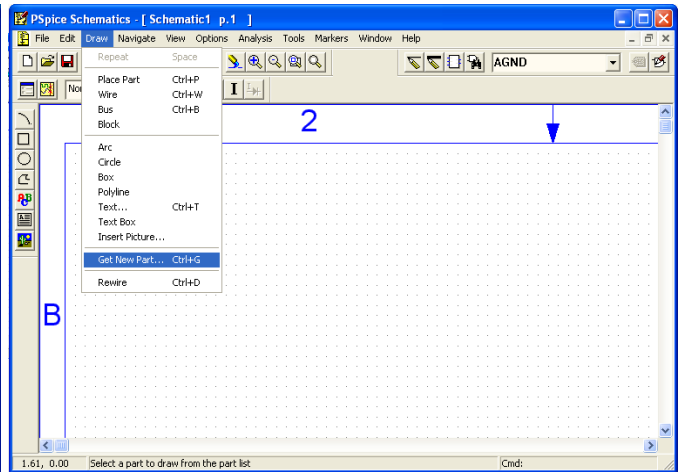
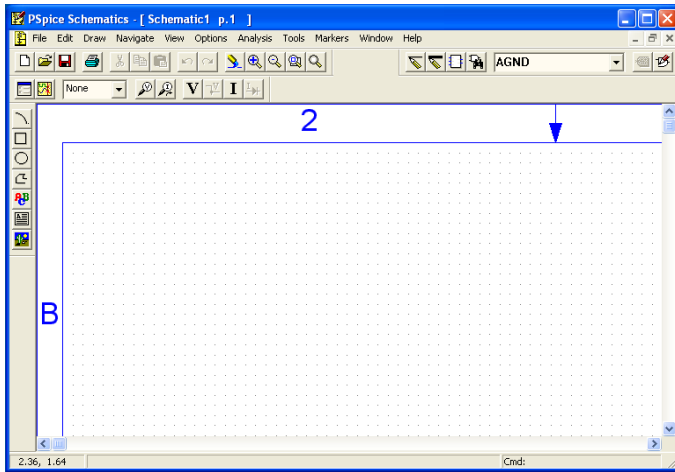
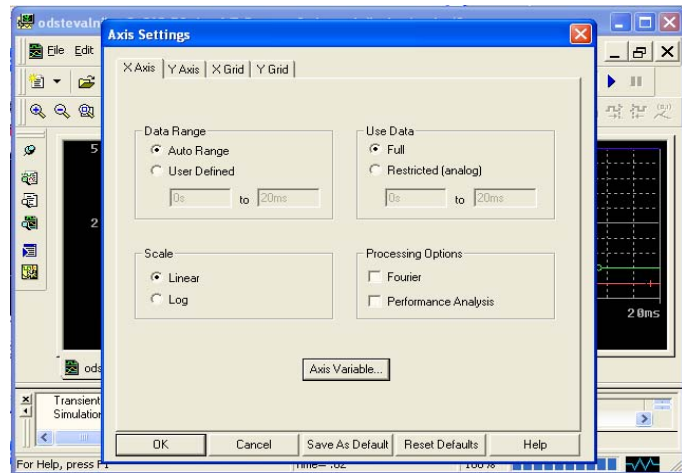
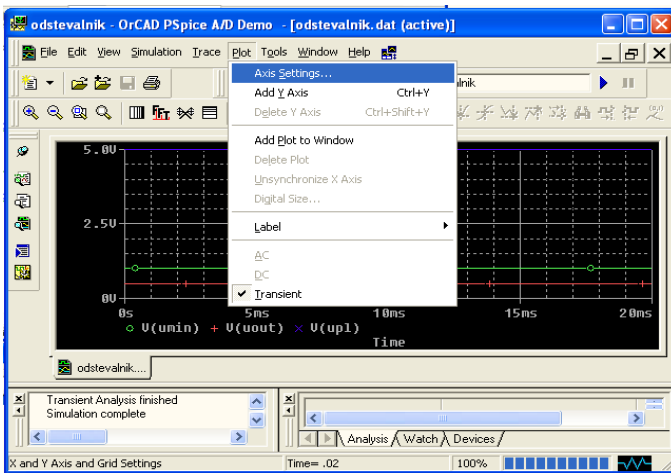
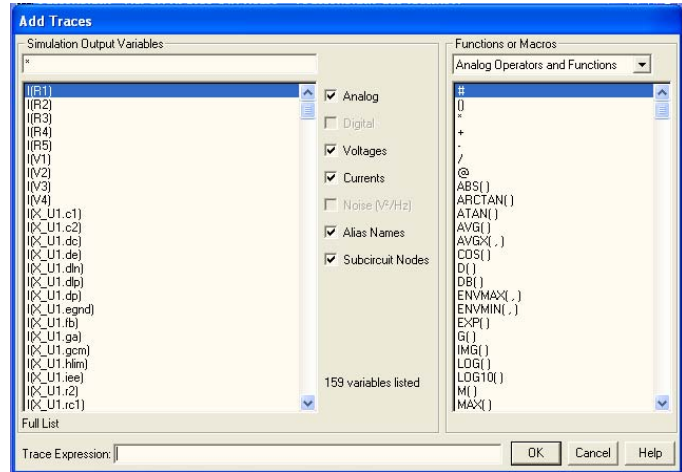
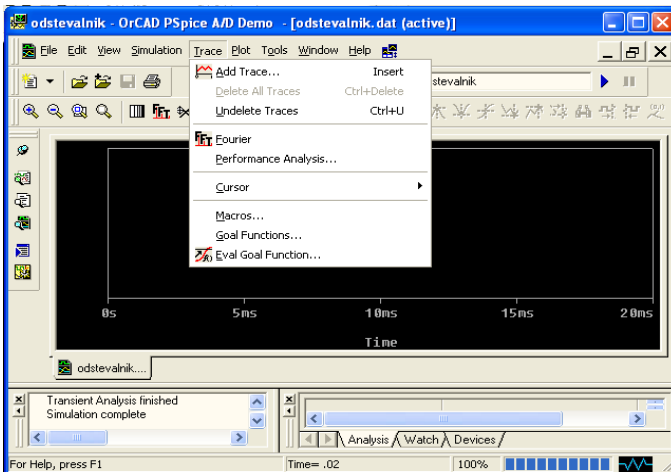
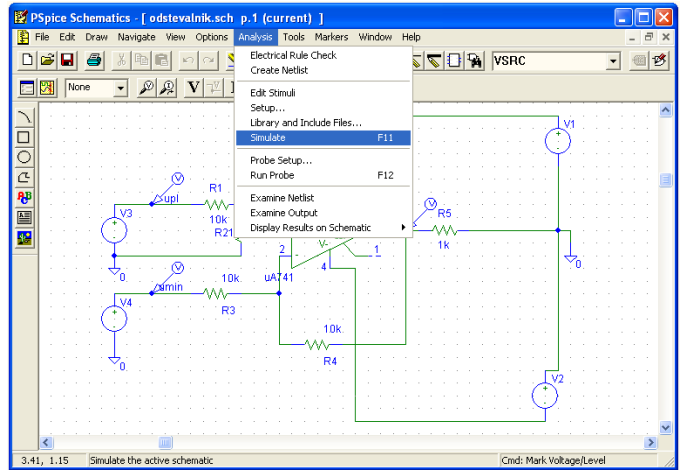
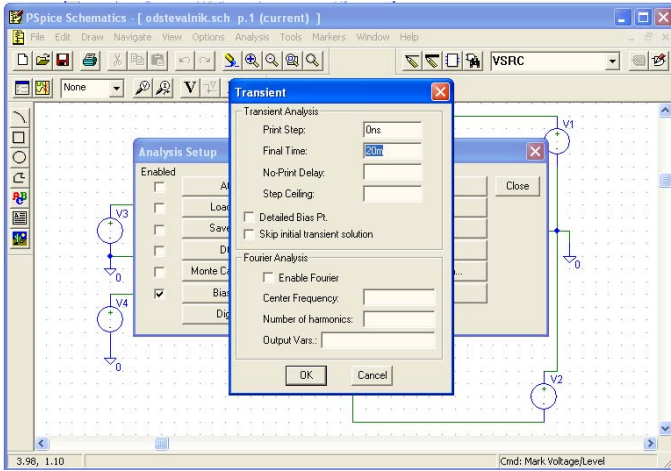
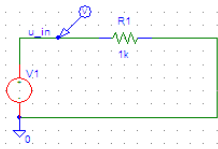

V1 PartName: VSRC

Name	Value
DC	=
AC	
TRAN	=sin(0 1.50 5m 25 0)
SIMULATIONONLY	=
PKGREF	=V1

Include Non-changeable Attributes
 Include System-defined Attributes

Buttons: Save Attr, Change Display, Delete, OK, Cancel

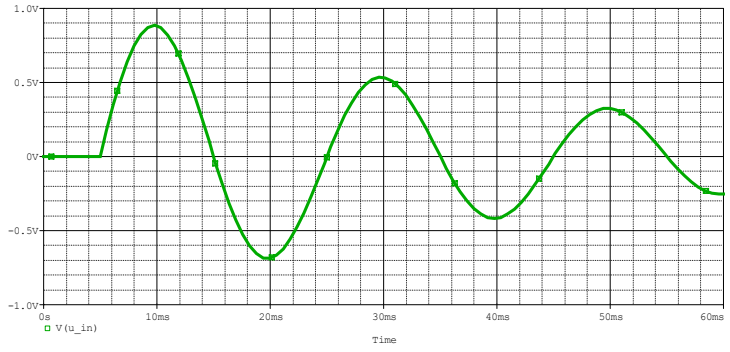

V1 PartName: VSRC

Name	Value
DC	=
AC	
TRAN	=sin(0.5 1.50 0 0 0)
SIMULATIONONLY	=
PKGREF	=V1

Include Non-changeable Attributes
 Include System-defined Attributes

Buttons: Save Attr, Change Display, Delete, OK, Cancel

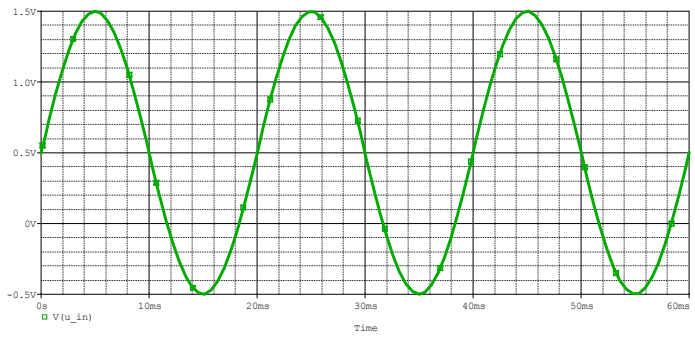

V1 PartName: VSRC

Name	Value
DC	=
AC	
TRAN	=pulse(-1 1 0 1m 2m 10m 20m)
SIMULATIONONLY	=
PKGREF	=V1

Include Non-changeable Attributes
 Include System-defined Attributes

Buttons: Save Attr, Change Display, Delete, OK, Cancel

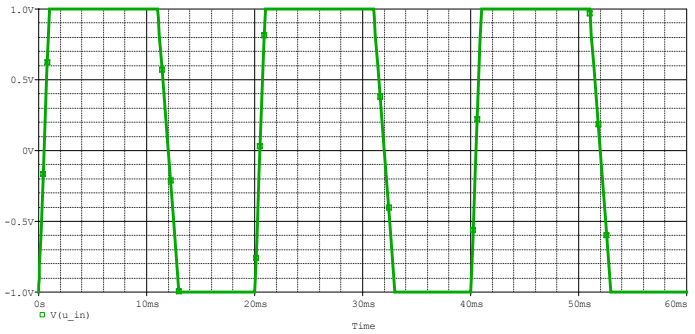

V1 PartName: VSRC

Name	Value
DC	=
AC	
TRAN	=pulse(0 1.5 0 1u 1u 10m 20m)
SIMULATIONONLY	=
PKGREF	=V1

Include Non-changeable Attributes
 Include System-defined Attributes

Buttons: Save Attr, Change Display, Delete, OK, Cancel

